

**ADDENDUM TO THE SAN ANTONIO PRECISE PLAN EIR
FOR PRECISE PLAN AMENDMENTS**

**THE VILLAGE AT SAN ANTONIO – PHASE III
PROJECT**

SCH #2014032001

PREPARED FOR:

City of Mountain View
Community Development Department
500 Castro Street, P.O. Box 7540
Mountain View, CA 94039-7540

PREPARED BY:

ICF
201 Mission Street, Suite 1500
San Francisco, CA 94105

February 2022



ICF. 2022. *Addendum to the San Antonio Precise Plan EIR for Precise Plan Amendments. The Village at San Antonio – Phase III Project.* February.
(ICF 104340.0.001.01.) San Francisco, CA. Prepared for City of Mountain View,
Mountain View, CA.

Contents

List of Tables/List of Figures	iii
List of Acronyms and Abbreviations.....	iv
Chapter 1 Introduction.....	1-1
1.1 Background	1-1
1.2 Previously Certified EIR.....	1-2
1.3 CEQA Review of the Project.....	1-2
1.4 Scope and Content of the Addendum	1-3
1.5 Addendum Organization.....	1-5
Chapter 2 Project Description	2-1
2.1 Project Overview	2-1
2.2 Project Objectives	2-1
2.3 Project Location	2-2
2.4 Existing Site Conditions and Surrounding Uses	2-2
2.5 Proposed Project.....	2-3
2.6 Construction.....	2-7
2.7 Required Permits and Approvals.....	2-8
Chapter 3 Environmental Impacts Checklist.....	3-1
Organization of This Section	3-1
Summary of Environmental Impacts.....	3-1
Topics Found to Have No Impact	3-1
Environmental Analysis	3-3
Applicable Mitigation Measures and Conditions of Approval.....	3-3
3.1 Air Quality	3.1-1
3.2 Biological Resources	3.2-1
3.3 Cultural Resources.....	3.3-1
3.4 Geology and Soils	3.4-1
3.5 Greenhouse Gas Emissions.....	3.5-1
3.6 Hazards and Hazardous Materials.....	3.6-1
3.7 Hydrology and Water Quality	3.7-1
3.8 Land Use and Planning	3.8-1
3.9 Noise.....	3.9-1
3.10 Population and Housing.....	3.10-1
3.11 Public Services and Recreation	3.11-1
3.12 Transportation and Traffic.....	3.12-1
3.13 Utilities and Service Systems	3.13-1

Chapter 4 Report Preparation 4-1

 4.1 City of Mountain View, Community Development Department (Lead Agency)..... 4-1

 4.2 ICF (Consultant)..... 4-1

 4.3 Schaaf & Wheeler (Consultant)..... 4-2

 4.4 Fehr & Peers (Consultant)..... 4-2

Chapter 5 References 5-1

APPENDICES

- A Air Quality Supporting Materials**
- B DPR Forms**
- C Noise Supporting Materials**
- D Multimodal Transportation Analysis**
- E Utility Impact Study**

List of Tables

3.0-1	Comparison of SAPP EIR Impacts and Proposed Project Impacts	3-3
3.0-2	Mitigation Measures and Conditions of Approval Summary Table.....	3-4
3.1-1	Criteria Air Pollutants.....	3.1-2
3.1-2	Project-Level Cancer and Chronic Hazard Risks and PM2.5 Concentrations During Project Construction	3.1-7
3.1-3	Maximum Cumulative Health Risks from the Proposed Project	3.1-8
3.3-1	Previously Recorded Archaeological Resources within 0.5 mile of the Project Site	3.3-1
3.9-1	Typical A-Weighted Sound Levels.....	3.9-2
3.9-2	Rules for Combining Sound Levels by Decibel Addition.....	3.9-3
3.9-3	Vibration Source Levels for Construction Equipment.....	3.9-5
3.9-4	Vibration Annoyance Potential Criteria Guidelines	3.9-5
3.9-5	Vibration Damage Potential Threshold Criteria Guidelines	3.9-5
3.9-6	Estimated Daytime Construction Noise during Expected Loudest Phase (L_{max} and L_{eq})	3.9-11
3.9-7	Traffic Noise Levels along Roadway Segments Adjacent to the Project Site	3.9-15
3.13-1	Baseline Sewer Flow for Existing Conditions and Project Conditions.....	3.13-5

List of Figures

	Follows Page	
2-1	Project Location	2-2
2-2	Existing Conditions in the Project Vicinity.....	2-2
2-3	Existing Site Conditions	2-2
2-4	Proposed Site Cross-Section	2-4
2-5	Site Plan—Level 1	2-4
2-6	Illustrative View of Proposed Project from the San Antonio Road and California Street Intersection	2-6
2-7	Proposed Landscape Plan.....	2-6

Acronyms and Abbreviations

AB	Assembly Bill
ADA	Americans with Disabilities Act
APN	assessor’s parcel number
ASTM	American Society for Testing Materials
BMP	best management practice
CAL FIRE	California Department of Forestry and Fire Protection
CALGreen	California Green Building Standards Code
CEQA	California Environmental Quality Act
CIP	Capital Improvement Program
City	City of Mountain View
CNEL	Community Noise Equivalent Level
COA	Conditions of Approval
CRHR	California Register of Historical Resources
dB	decibel
dBA	A-weighted decibel
DPR	Department of Parks and Recreation
EIR	environmental impact report
FAR	floor area ratio
FEMA	Federal Emergency Management Agency
FHWA	Federal Highway Administration
General Plan	City of Mountain View 2030 General Plan
GGRP	Greenhouse Gas Reduction Plan
GHG	greenhouse gas
gpd	gallon per day
gpm	gallon per minute
GPUUIS	General Plan Update Utility Impact Study
gsf	gross square foot
HVAC	heating, ventilating, and air-conditioning
in/sec	inch per second
IS	initial study

LASD	Los Altos School District
L_{dn}	day-night level
LED	light-emitting diode
LEED	Leadership in Energy and Environmental Design
L_{eq}	equivalent sound level
LID	low-impact development
L_{max}	maximum sound level
LOS	level of service
LTS	level of traffic stress
LUD	Land Use Designation
LUST	leaking underground storage tank
MRP	Municipal Regional Permit
MTA	San Antonio Center Phase III Multimodal Transportation Analysis
MTC	Metropolitan Transportation Commission
MVFD	Mountain View Fire Department
MVLA UHSD	Mountain View-Los Altos Union High School District
MVPD	Mountain View Police Department
NPDES	National Pollutant Discharge Elimination System
NRHP	National Register of Historic Places
NWIC	Northwest Information Center
Phase I ESA	Phase I Environmental Site Assessment 365 San Antonio Road and 2585 and 2595 California Street Mountain View, California
PPV	peak particle velocity
PRC	Public Resources Code
project	Village at San Antonio Center – Phase III Project
REC	recognized environmental condition
RWQCP	Regional Water Quality Control Plant
SAPP	San Antonio Precise Plan
SCVURPPP	Santa Clara Valley Urban Runoff Pollution Prevention Program
SCVWD	Santa Clara Valley Water District
SR	State Route
SWPPP	stormwater pollution prevention plan
TDM	transportation demand management

TDR	transfer of development rights
TPA	Transit Priority Area
VMT	vehicle miles traveled
VTA	Santa Clara Valley Transportation Agency

1.1 Background

The San Antonio Precise Plan (SAPP), which the City of Mountain View (City) adopted in 2014, applies to approximately 123 acres of land near the western edge of the City. Included in the SAPP area are major roadways, such as El Camino Real, San Antonio Road, California Street, and Showers Drive. The SAPP implements goals and policies set forth in the *City of Mountain View 2030 General Plan* (General Plan) for the area. The SAPP provides guiding principles, policies, development criteria, and implementation strategies for transforming the existing commercial area into a mixed-use core within a broader residential neighborhood, while maximizing the area's proximity to transit services and regional roadways. Specifically, it provides the development framework for two main subareas, the Mixed-Use Center (approximately 60 acres) and the Mixed-Use Corridor (approximately 53 acres). The SAPP area encourages a combination of uses, including office, commercial, retail, and residential.

Included in the SAPP is an office development cap to prioritize residential development and balance office development with future housing growth. The SAPP currently stipulates an areawide maximum of 600,000 square feet of net new office development, with up to 400,000 square feet permitted in the *Northwest San Antonio Center Master Plan Area*. Office development beyond this cap will require an amendment to the SAPP.

The Addendum to the San Antonio Precise Plan EIR for Precise Plan Amendments to the Village at San Antonio – Phase III Project (project) is located at 365 and 405 San Antonio Road and 2585 and 2595 California Street within the SAPP Mixed-Use Center Subarea and the Northwest San Antonio Master Plan Area of the SAPP. The project proposes the demolition of two single-story commercial buildings and associated surface parking, and the construction of a commercial building with public open spaces and below-grade parking garage at the southeast corner of California Street and San Antonio Road on an approximately 0.99-acre site. The project would construct a seven-story building with ground-floor retail and six levels of office uses above, along with three levels of subterranean parking that would connect to the adjacent underground parking for Phase II of the Village at San Antonio Center Project. Upon project completion, the total building area would measure approximately 182,352 gross square feet (gsf), including approximately 12,970 gsf of ground floor retail space and approximately 169,382 gsf of office space. The project site currently comprises four lots that would be merged into one lot as part of an entitlement process.

Under the SAPP, the Mixed-Use Center Subarea allows development with a FAR of up to 2.35, of which 0.75 can be office or commercial uses. In addition, the SAPP currently limits net new office development to 600,000 gsf, of which 400,000 gsf is permitted in the Northwest San Antonio Master Plan Area.

The project proposes minor amendments to the SAPP to modify the office development cap in the Northwest San Antonio Master Plan area to allow additional office area through the Transfer of Development Rights for Public Schools and update the regulations governing Transfer Development Rights for Public Schools. The existing 600,000 gsf office development limit in the SAPP as a whole would remain.

The City Council authorized the project site as a receiving site under the City's Transfer of Development Rights (TDR) program with Los Altos School District (LASD). Per the authorization, the project applicant would seek an agreement to identify the project site as a receiving site under the City's TDR program, allowing the 150,000 gsf transfer from the Los Altos School District to be exempt from FAR calculations.

1.2 Previously Certified EIR

The *SAPP Draft Environmental Impact Report* (EIR) was published in September 2014, and the Final EIR, including responses to comments on the Draft EIR, was published in November 2014. The Final EIR was certified in December 2014. As described in more detail below, this document is an addendum to the certified Final EIR, prepared under CEQA Guidelines Sections 15168(c) and 15164. The conclusions of the Final EIR are briefly summarized at the beginning of the analysis for each of the environmental topics in this document (see Section 1.4.1, *Resource Topics*, below). Applicable mitigation measures presented in the SAPP EIR are incorporated into the analysis of each environmental topic, as appropriate.

Implementation of the project would require certain approvals from the City and other agencies. To allow construction of the seven-story, mixed-use building and related improvements, a lot line adjustment, precise plan amendment, master plan permit, planned community permit, development review permit, development agreement, provisional use permit, and heritage tree removal permit would be pursued.

1.3 CEQA Review of the Project

When revisions are proposed to a project after an EIR has been certified, an agency must determine whether an addendum or a supplemental or subsequent EIR is the appropriate document for analyzing the potential impacts of the revised project. Per California Environmental Quality Act (CEQA) Guidelines Sections 15162(a) and 15163, a supplemental or subsequent EIR is required if:

1. Substantial changes are proposed in the project that will require major revisions of the previous EIR or negative declaration due to the involvement of new significant environmental effects or a substantial increase in the severity of previously identified significant effects;
2. Substantial changes occur with respect to the circumstances under which the project is undertaken that will require major revisions of the previous EIR or negative declaration due to the involvement of new significant environmental effects or a substantial increase in the severity of previously identified significant effects; or
3. New information of substantial importance that was not known and could not have been known with the exercise of reasonable diligence at the time the previous EIR was certified as complete, shows any of the following:
 - A. The project will have one or more significant effects not discussed in the previous EIR;
 - B. Significant effects previously examined will be substantially more severe than shown in the previous EIR;

- C. Mitigation measures or alternatives previously found not to be feasible would, in fact, be feasible and would substantially reduce one or more significant effects of the project, but the project proponents decline to adopt the mitigation measure or alternative; or
- D. Mitigation measures or alternatives that are considerably different from those analyzed in the previous EIR would substantially reduce one or more significant effects on the environment, but the project proponents decline to adopt the mitigation measure or alternative.

If none of the above conditions apply, then an addendum is the appropriate environmental document for analyzing a revised project. Pursuant to CEQA Guidelines Section 15164(e), the addendum must provide a brief explanation regarding the decision to not prepare a supplemental EIR. The necessary explanation is set forth below.

As described in Chapter 2, *Project Description*, the proposed amendments to the SAPP increase the 400,000-gsf limit on net new office development within the *Northwest San Antonio Master Plan*, while maintaining the existing 600,000-gsf office development limit in the SAPP as a whole. Furthermore, the project would seek an agreement to identify the project site as a receiving site under the City's TDR program, allowing the 150,000-gsf transfer from the Los Altos School District exemption from FAR calculations. The sending site is within the San Antonio Precise Plan and does not change the maximum allowable gsf studied in the San Antonio Precise Plan EIR.

As demonstrated throughout this addendum, the proposed project would not result in new significant impacts or increases in the severity of previously identified significant impacts, and would not trigger the need for new or considerably different mitigation measures that were not identified in the certified Final EIR, thereby rendering a supplemental or subsequent EIR necessary. Since the Final EIR was certified in December 2014, there have been changes to the background conditions in the Plan Area, and portions of the area have been constructed. However, because the changes are not substantial, the changed circumstances would not require major revisions to the Final EIR. For the foregoing reasons, no supplemental EIR is necessary. Accordingly, as described further in this document, an addendum is the appropriate mechanism for CEQA review of the proposed project.

1.4 Scope and Content of the Addendum

As permitted by CEQA Guidelines, this addendum has referenced numerous technical studies, analyses, previously certified environmental documentation, and planning documents, which have been incorporated by reference. Information from the documents has been briefly summarized in the appropriate section(s). The relationship between the incorporated part of the referenced document and the draft EIR has also been described, as appropriate. The documents and other sources used in the preparation of this addendum are provided in the appendices or listed in Chapter 5, *References*, of this addendum.

Consistent with CEQA Guidelines Sections 15168 (c) and 15162, this addendum compares the project-level environmental impacts of the proposed project to those identified in the SAPP EIR. The environmental impacts of the project are analyzed in this addendum to the degree of specificity appropriate, in accordance with CEQA Guidelines Section 15146.

This addendum evaluates the potential impacts of the project on the following areas:

- Air Quality
- Biological Resources
- Cultural Resources
- Geology and Soils
- Greenhouse Gas Emissions
- Hazards and Hazardous Materials
- Hydrology and Water Quality
- Land Use and Planning
- Noise
- Population and Housing
- Public Services and Recreation
- Transportation and Traffic
- Utilities and Service Systems

This addendum does not include certain CEQA resource topics because the proposed project would cause no impact to them, as described below.

- **Aesthetics.** The SAPP EIR concluded that with adherence to and implementation of the identified General Plan policies and actions, and the SAPP Development Standards and Guidelines, development with the Plan Area, including the project site, would result in less-than-significant aesthetic impacts. Due to the proposed project's location within the SAPP area and other characteristics, the proposed project is deemed to have no impact, rather than a less than significant impact, on aesthetics. The project is on an infill site, within a Transit Priority Area (TPA), and is considered an employment-center project; consequently, in accordance with Public Resources Section (PRC) 21099, aesthetics and vehicular parking are not considered CEQA impacts.
- **Agricultural Resources.** The project site is already developed with urban uses in an urbanized environment. There are no farmlands within or near the project site that would be affected by the proposed project. There is no prime farmland or farmland of statewide importance within the Plan Area. Therefore, there would be no impact on agricultural resources.
- **Mineral Resources.** The SAPP EIR does not identify any mineral resources within the Plan Area, and there are no known mineral resources at the project site. The proposed project would not result in the loss of availability of known mineral resources of regional or statewide importance. Therefore, there would be no impact on mineral resources.
- **Wildfire.** An analysis of wildfire is required only if the project site is in or near State Responsibility Areas or lands that have been classified as Very High Fire Hazard Severity Zones. The Plan Area, inclusive of the project site, is not in one of these designated areas. Therefore, there would be no impact related to wildfire.

1.5 Addendum Organization

This addendum is organized in the chapters and appendices described below.

- Chapter 1, *Introduction*, includes a brief overview of the project, an overview of the environmental review process, and the scope, content, and organization of the addendum.
- Chapter 2, *Project Description*, includes a comprehensive description of the project.
- Chapter 3, *Environmental Impacts Checklist*, includes an evaluation of the resource topics outlined in Section 1.4, *Scope and Content of the Addendum*. Each resource-specific section briefly summarizes the conclusions of the certified Final EIR and presents the potential impacts of the project relative to the impacts of the certified Final EIR.
- Chapter 4, *Report Preparation*, includes a list of staff members who contributed to preparation of the addendum.
- Chapter 5, *References*, includes a list of the printed references and personal communications cited in the addendum.

Appendices

- A Air Quality Supporting Materials
- B DPR Forms
- C Noise Supporting Materials
- D Multimodal Transportation Analysis
- E Utility Impact Study

2.1 Project Overview

The San Antonio Precise Plan (SAPP), which the City of Mountain View (City) adopted in 2014, applies to approximately 123 acres of land near the western edge of the city. Included in the SAPP area are major roadways, such as El Camino Real, San Antonio Road, California Street, and Showers Drive. The SAPP implements goals and policies set forth in the *City of Mountain View 2030 General Plan* (General Plan) for the area. Specifically, it provides the development framework for two main subareas, the Mixed-Use Center (approximately 60 acres) and the Mixed-Use Corridor (approximately 53 acres). The SAPP area encourages a combination of uses, including office, commercial, retail, and residential uses.

The Addendum to the San Antonio Precise Plan EIR for Precise Plan Amendments to the Village at San Antonio – Phase III Project (project) is located at 365 and 405 San Antonio Road and 2585 and 2595 California Street within the SAPP. The SAPP provides guiding principles, policies, development criteria, and implementation strategies for transforming the existing commercial area into a mixed-use core within a broader residential neighborhood, while maximizing the area’s proximity to transit services and regional roadways. The project proposes the demolition of two single-story commercial buildings and associated surface parking and the construction of a commercial building with public open space and below-grade parking at the intersection of California Street and San Antonio Road. On project completion, the total building area would measure approximately 182,352 gross square feet (gsf), including approximately 12,970 gsf of ground floor retail space and approximately 169,382 gsf of office space.

Included in the SAPP is an office development cap to prioritize residential development and balance office development with future housing growth. The SAPP currently stipulates an areawide maximum of 600,000 square feet of net new office development, with up to 400,000 square feet permitted in the Northwest San Antonio Center Master Plan Area. Office development beyond this cap will require an amendment to the SAPP.

2.2 Project Objectives

The project includes the following objectives to implement key SAPP project objectives on the Phase III Project site, with site-specific objectives italicized:

- Contribute to the revitalization of the SAPP plan area as a diverse and dynamic mixed-use environment, *including responding to existing demand for office and commercial uses.*
- Create pedestrian-oriented site and building design, active frontages, and increased tree canopy.
- Promote placemaking principles and create well-programmed and designed open space amenities.
- Promote well-integrated development, including coordinated public access, shared parking, wayfinding signage and other amenities supporting the image and function of a cohesive area, *including by integrating the Phase III Project into the existing Phase 1 and Phase II development at San Antonio Center.*

- Promote transit services through higher-intensity, transit-oriented development and improved bicycle and pedestrian connections, *including locating job-generating uses within close proximity to public transit.*
- Encourage shared parking and access across multiple sites.

2.3 Project Location

The approximately 0.99-acre project site comprises four lots at 2585–2595 California Street and 365 and 405 San Antonio Road, in a largely mixed-use area in the western portion of the city (Figure 2-1). Specifically, the project site is at the southeastern corner of the California Street and San Antonio Road intersection and bounded by California Street to the north, Silicon Way and commercial office buildings to the south, Promenade Lane and commercial buildings to the east, and San Antonio Road to the west. Properties surrounding the immediate area include multi-family residential uses and commercial uses, including a movie theater to the east and a gas station to the west, as shown in Figure 2-2. The project site is approximately 0.3 mile north of State Route (SR) 82 (El Camino Real), 1.4 miles south of U.S. 101, and 2.6 miles west of SR 85. The site currently consists of four legal lots, assessor's parcel numbers 148-322-005, 148-22-006, 148-22-007, and 148-22-023.

2.4 Existing Site Conditions and Surrounding Uses

2.4.1 Project Site Land Uses

The project site consists of four lots. Existing site conditions are shown in Figure 2-3. The site currently comprises two single-story commercial buildings and surface parking lots. The building at 365 San Antonio Road is an approximately 5,008-gsf commercial office building, currently occupied by a pharmacy (PerceptiMed). The building at 2585 California Street is an approximately 4,386 gsf retail building, previously occupied by a grocery market (Milk Pail). A temporary pop-up drive-through produce market has occupied the former Milk Pail site for the past several months. In addition, there are approximately 45 surface parking spaces on the project site.

The existing project site has a floor area ratio (FAR) of 0.21, or approximately 9,394 square feet. Approximately 12 people are currently employed at the project site. There are approximately 22 trees on the project site, including five Heritage Trees. The existing access points to the project site are from California Street and San Antonio Road. The topography of the project site is generally flat. In addition to the features described above, the site contains intermittent paving for parking and pedestrian uses. Landscaping is found throughout the site.

2.4.2 Land Use Designation and Zoning

The City of Mountain View is organized into several geographic areas, called *planning areas*. The project site is within the San Antonio Planning Area, which includes a variety of commercial, office, retail, and residential uses. The General Plan also defines several *change areas*, which are areas within the city that could significantly change over the life of the General Plan. The General Plan identifies new land uses and intensities for change areas, primarily in industrial areas along transportation corridors and in commercial locations. The project site is within the San Antonio change area.

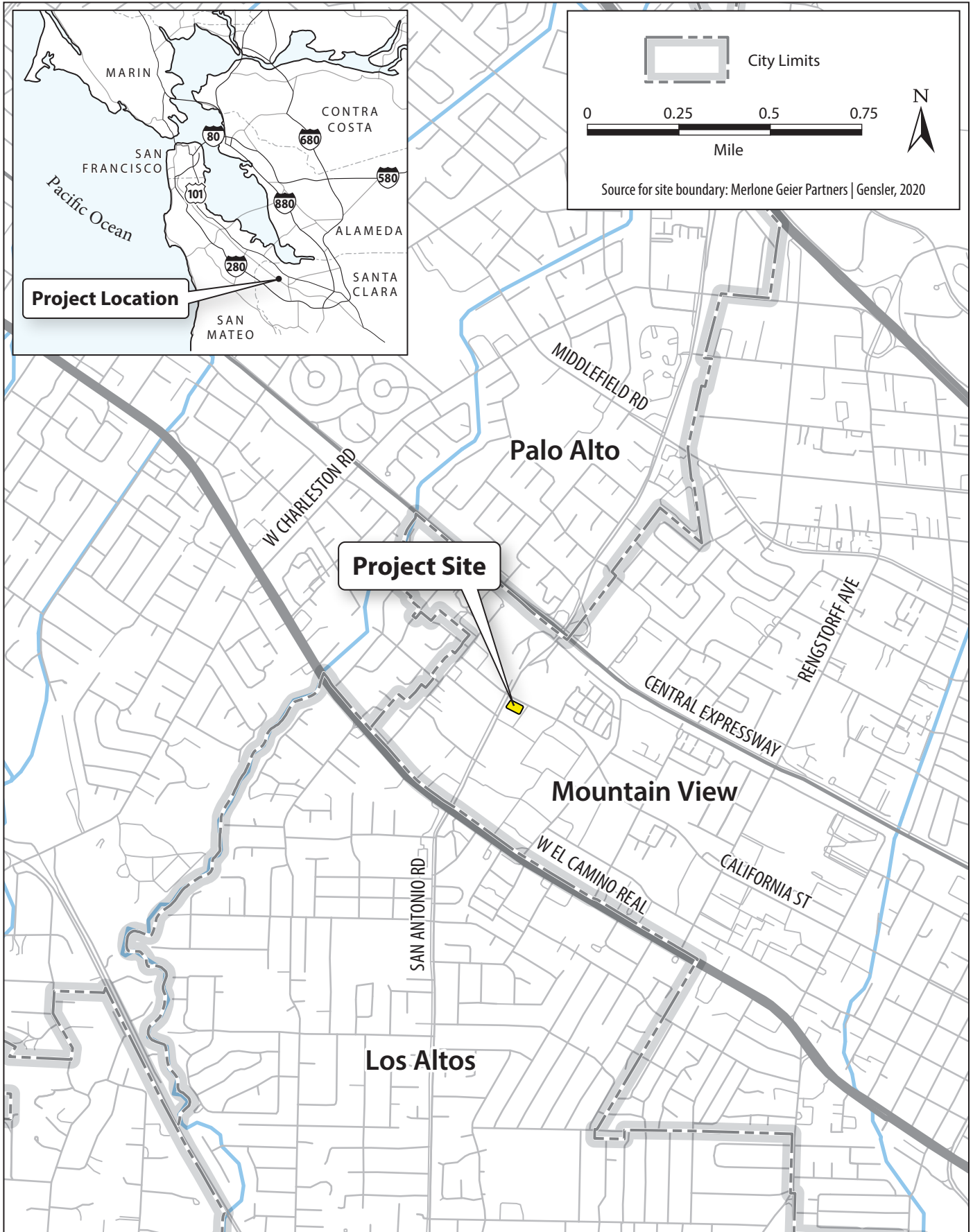

Graphics... 00693.20 (3/7/10/21) AB



Figure 2-1
Project Location
The Village at San Antonio Center—Phase III Project



a. View of Promenade Lane facing north.



b. View of construction site facing east immediately north of the Project site across California Street.



c. View of office and commercial buildings surrounding Project site facing southeast.

ICF Graphics...00693.20 (6/6/21) AB



Figure 2-2
Existing Conditions in the Project Vicinity
San Antonio Phase III



a. View of existing commercial building from Silicon Way.



b. View of Project site from the Silicon Way and Promenade Lane intersection.



c. View of existing commercial building from San Antonio Road.



d. View of existing commercial buildings from San Antonio Road and California Street Intersection.

ICF Graphics...00693.20 (4/6/21) AB



Figure 2-3
Existing Site Conditions
San Antonio Phase III

The General Plan designates the project site as a Mixed-Use Center, which allows for a mix of pedestrian-oriented uses, as well as integrated and complementary uses, such as residential, office, or retail uses, to draw visitors from surrounding neighborhoods and the region. The General Plan describes the permitted uses for the project site, which include offices, retail and personal services, multi-family residences, lodging facilities, entertainment venues, parks, and plazas. The project site is also within the Mixed-Use Center Subarea and the Northwest San Antonio Master Plan Area of the SAPP.

The project site is currently zoned P-40 (San Antonio Precise Plan). This zoning district is designed to provide uses or combinations of uses that may be developed appropriately as part of the San Antonio Precise Plan Area development. Specifically, it provides a development framework for two main subareas, the Mixed-Use Center (approximately 60 acres) and the Mixed-Use Corridor (approximately 53 acres). Furthermore, the zoning designation allows for a combination of uses, including office, commercial, retail, and residential. The existing commercial uses onsite are consistent with the existing General Plan land use designation and zoning for the project site.

2.4.3 Surrounding Land Uses

Surrounding land uses include other mixed uses, as well as medium-density residential uses. Immediately east of the project site is a movie theater (ShowPlace ICON Mountain View); a gas station (Valero) is immediately west of the project site. North of California Street are existing multi-family residence uses, along with the site for future residential uses; professional offices are south of the project site.

2.5 Proposed Project

The project proposes demolition of two single-story commercial buildings, as well as associated surface parking, and construction of a commercial building with open spaces and a below-grade parking garage at the intersection of California Street and San Antonio Road on an approximately 0.99-acre site. The project would construct a seven-story building with ground-floor retail and six levels of office uses above, along with three levels of subterranean parking that would connect to the adjacent underground parking for Phase II of the Village at San Antonio Center Project (Figure 2-4). On project completion, the total building area would measure approximately 182,352 gsf, including approximately 12,970 gsf of retail space and approximately 169,382 gsf of commercial/office space. The project site currently comprises four lots that would be merged into one lot as part of an entitlement process.

The proposed building would be approximately 95 feet high.¹ The project would exceed the allowable FAR (2.35) set forth in the SAPP consistent with the additional FAR permitted through the City's Transfer of Development Rights (TDR) program. The project would not exceed the maximum allowable building height (95 feet) for the site².

To allow construction of the seven-story, mixed-use building and related improvements, a lot line adjustment, precise plan amendment, master plan permit, planned community permit, development review permit, development agreement, provisional use permit, and heritage tree removal permit would be pursued.

¹ The building would be 105 feet high at the top of the mechanical screen.

² Per the SAPP, up to an additional 10 feet of overall height is allowed with a Provisional Use Permit for rooftop amenities.

The first floor, or ground floor, of the proposed building would measure approximately 25,270 gsf and include approximately 12,970 gsf of commercial retail space, an approximately 1,500 gsf office lobby, and space for generators/transformers, an electrical room, bathrooms, and office support (Figure 2-5). In addition, an approximately 325 gsf, single-story retail structure would be located along Promenade Lane, adjacent to proposed public open space (described in more detail below). There would also be one loading and service area on the ground floor along Silicon Way. Floors two through six would provide office space, ranging from approximately 15,247 gsf to 31,000 gsf. The subterranean parking garage would provide parking for approximately 283 cars, with each of the three levels measuring approximately 36,450 square feet

Project implementation would provide private and public open spaces throughout the site. The streetscape would consist of at-grade and raised planters with built-in seating. A series of at-grade planting buffers would be situated between the street and the sidewalk to mitigate noise and block views. In addition, benches, bicycle racks, and lighting would be provided, per City and California Green Building Standards Code (CALGreen) requirements. Approximately 20,633 square feet of public open space would be provided on the ground floor of the building, including landscape, seating areas and outdoor dining. A public plaza would be located at the corner of California Street and San Antonio Road, as well as an outdoor seating area along Promenade Lane. In addition, approximately 17,715 square feet of private open space would be provided onsite, including balconies and landscaping on the upper floors.

A total of approximately 1,500 office employees would work at the project site upon completion and occupancy of the new building.

2.5.1 San Antonio Precise Plan Amendment and Transfer of Development Rights

The project site is within the Mixed-Use Center Subarea and the Northwest San Antonio Master Plan Area of the SAPP.

Under the SAPP, the Mixed-Use Center Subarea allows development with a FAR of up to 2.35, of which 0.75 can be office or commercial uses. In addition, the SAPP currently limits net new office development to 600,000 gsf, of which 400,000 gsf is permitted in the Northwest San Antonio Master Plan Area.

To implement the project, the project applicant proposes an amendment to the SAPP and minor amendments to the SAPP to modify the office development cap in the Northwest San Antonio Master Plan area to allow additional office development through the Transfer of Development Rights for Public Schools and update the regulations governing Transfer Development Rights for Public Schools. The existing 600,000 gsf office development limit in the SAPP as a whole would remain.

The City Council authorized the project site as a receiving site under the TDR program with Los Altos School District (LASD). Per the authorization, the project applicant would seek an agreement to identify the project site as a receiving site under the City's TDR program, allowing the 150,000 gsf transfer from the Los Altos School District to be exempt from FAR calculations. Additional required approvals from the City and other agencies are identified in Section 2.7, *Required Permits and Approvals*.

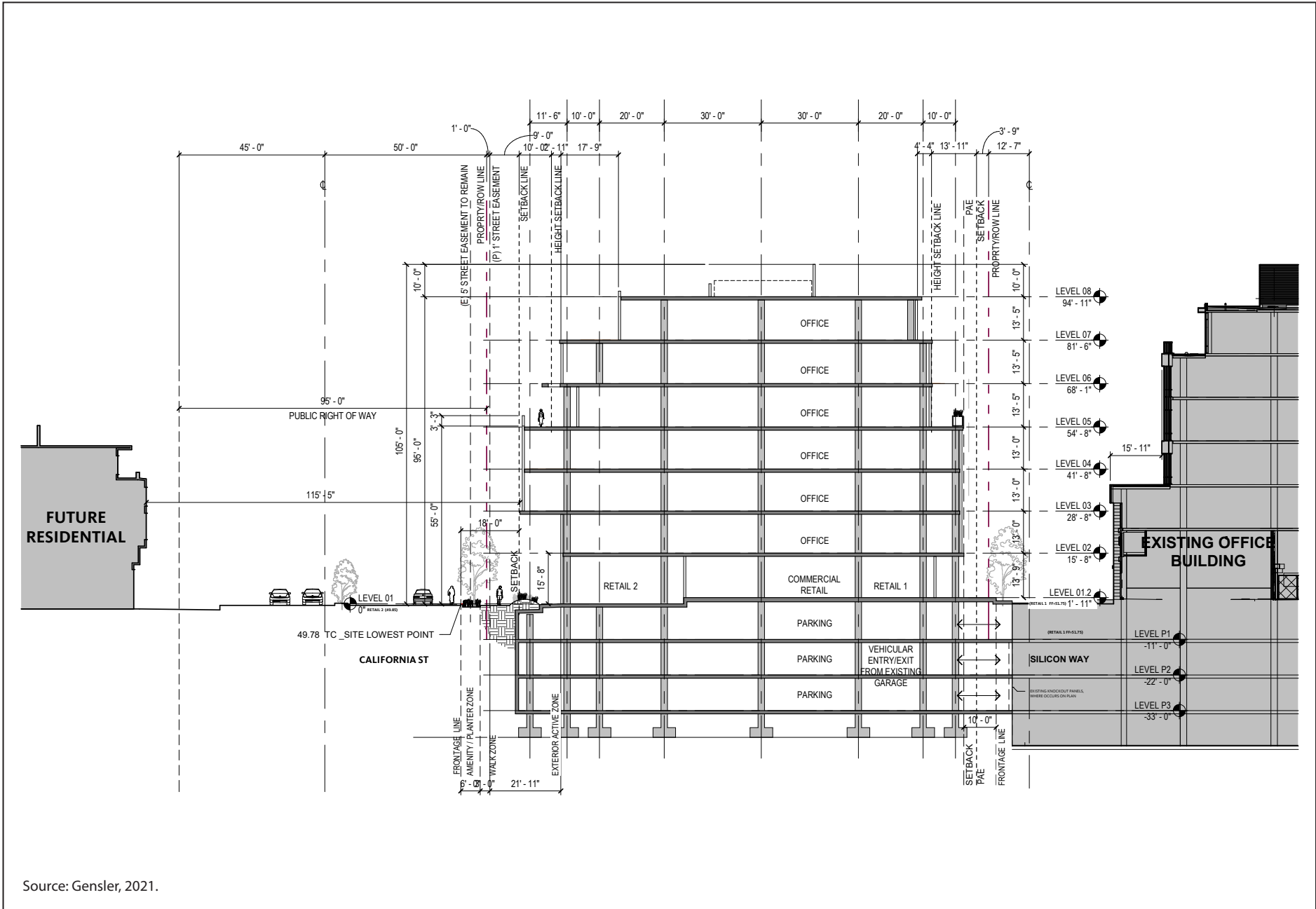

Source: Gensler, 2021.

ICF Graphics...00693.20 (1/18/21) A8



Figure 2-4
Proposed Site Cross-Section
 San Antonio Phase III

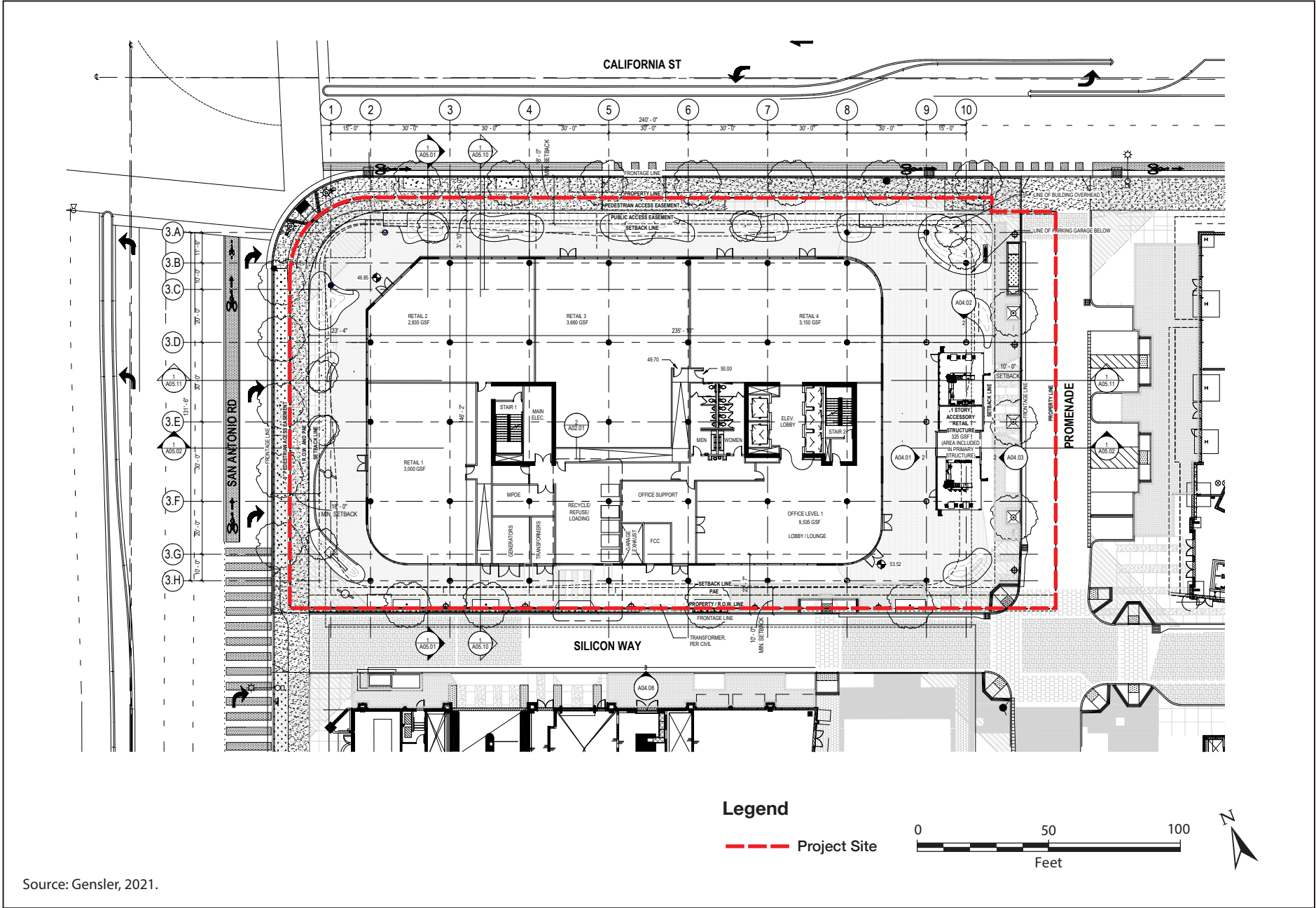

ICF Graphics...00693.20 (10/5/21) A8



Figure 2-5
Site Plan—Level 1
 San Antonio Phase III

2.5.2 Site Access, Circulation, and Parking

As shown in Figure 2-5, vehicular access to the project site would be provided from San Antonio Road, similar to existing conditions. The project would include one entrance and one exit for the subterranean parking garage through the adjacent underground parking garage that was completed as part of the Phase II Village at San Antonio Center Project. The access to the joint underground garage is off San Antonio Road and under Silicon Way. The project would also include approximately 283 vehicle parking spaces in the three levels of below-grade parking, including spaces that would be reserved for Americans with Disabilities Act (ADA)-compliant vehicles, in accordance with applicable requirements. In addition, the project would meet the City of Mountain View's Building Code electric vehicle parking requirements by providing electric-vehicle charging stations onsite.

The project would enhance the site's pedestrian and bicyclist connectivity. Pedestrian pathways would be provided around the exterior of the proposed building to promote circulation between the various commercial uses. Existing bicycle lanes along California Street and San Antonio Road would be maintained. The project would also provide Type I and Type II bicycle parking and bicycle storage onsite. In total, approximately 48 bicycle parking spaces would be provided onsite, including 28 permanent bicycle lockers and 20 bicycle racks.

Emergency vehicles would be able to access the project site from one location on California Street and one location on San Antonio Road. In addition, the internal project streets of Silicon Way and Promenade Lane would provide full emergency access around the project site. Silicon Way is approximately 22 feet wide; Promenade Lane is approximately 26 feet wide. Furthermore, additional fire hydrants would be installed at the project site.

The project would include one new loading berth along Silicon Way.

2.5.3 Building Design and Sustainability Features

The project would be designed to integrate the surrounding aesthetic and enhance the pedestrian experience at the major intersection of California Street and San Antonio Road. Balconies, decks, punched openings, colonnades, and other details, such as mullion frames, would be incorporated into the building design to create visual interest. The building exterior would comprise various materials, including limestone, glass, wood, architectural concrete, and metals (Figure 2-6). Façade articulation between glass and solid materials and landscaping at each wraparound deck would be incorporated to reduce solar exposure and the heat island effect. The project's design would help reduce the visual size and scale of the building.

Accent lighting would be provided to highlight the proposed building's architectural features, such as corners and lobbies.

The project applicant intends to pursue Leadership in Energy and Environmental Design (LEED) Gold certification for the project. The multitude of sustainable strategies that could be incorporated include low-flow plumbing fixtures, Energy Star appliances, light-emitting diode (LED) technology, drought-tolerant landscaping, low-flow irrigation systems, bio-filtration planters for stormwater management, a highly efficient building envelope to mitigate solar heat gain, light-colored surfaces, and below-grade parking to reduce the heat island effect. In addition, 14 percent of the vehicle parking spaces would be designated for electric, clean air, or vanpool vehicles. Outlets would be provided for recharging electric vehicles.

2.5.4 Landscaping and Heritage Trees

The project would include a landscape plan to compensate for the removal of trees and vegetation and enhance the development. Figure 2-7 shows the proposed landscaping elements for the project.

There are 22 trees on the project site. Of these, five meet the City's criteria for Heritage Trees. It is anticipated that 13 trees, including the five Heritage Trees, would need to be removed for project construction. Upon project buildout, 28 trees would be provided on the site, including nine existing trees and 19 new trees. All trees and other landscape would be planted be in compliance with the provisions of City and California Water Conservation in Landscaping Regulations. All planted areas would be watered with an approved irrigation system to make efficient use of water through conservation techniques, in compliance with applicable City and State regulations.

With implementation of the project, the streetscape would consist of at-grade and raised planters with built-in seating. In addition, streetscape improvements would include a combination of new trees and transplanted trees. Landscape would surround the building frontages up to the street.

2.5.5 Utilities

Given the already developed nature of the site, the project would be able to connect to existing City utilities, as described below. The project would provide new utility service connections for domestic water, recycled water, storm drains, sanitary sewer lines, gas lines, communications infrastructure, and electrical service. Off-site utility improvements are not anticipated. All new utilities would maintain the standard City horizontal clearance from trees (i.e., 5 feet for water utilities and 10 feet for sewers).

2.5.5.1 Water

The project proposes to construct new wet utility service connections. Two 2-inch domestic water connections are proposed to connect to an existing 10-inch main in California Street. One of these connections would be connected in the future to recycled water mains once extended into the project area. In addition, an 8-inch fire service would be connected to the 10-inch main in California Street. Further, an existing 1.5-inch domestic water meter from San Antonio Road may be converted to an irrigation service or new 1.5-inch irrigation service as part of the proposed project. The irrigation service line would be converted to recycled water when it becomes available to the project site and surrounding area.

2.5.5.2 Wastewater

The proposed project would include a 6-inch sanitary sewer connection to an existing 8-inch main in California Street. All other existing wastewater utility infrastructure would remain.

2.5.5.3 Stormwater

The proposed project would install two 8-inch storm drains that would also connect to an existing 30-inch storm main in California Street. High capacity bio-filtration best management practices would be used on the project site to treat stormwater. In addition, planter boxes and a LID-based treatment system would be used to treat stormwater runoff from the roof of the proposed building. Further, proprietary biofiltration units and non-LID treatment systems would be used to treat ground-level stormwater runoff.

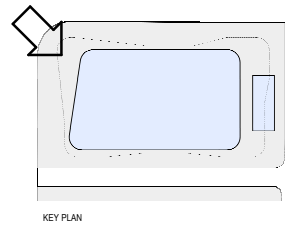

Source: Gensler, 2021.



Figure 2-6
Illustrative View of Proposed Project from the
San Antonio Road and California Street Intersection
San Antonio Phase III

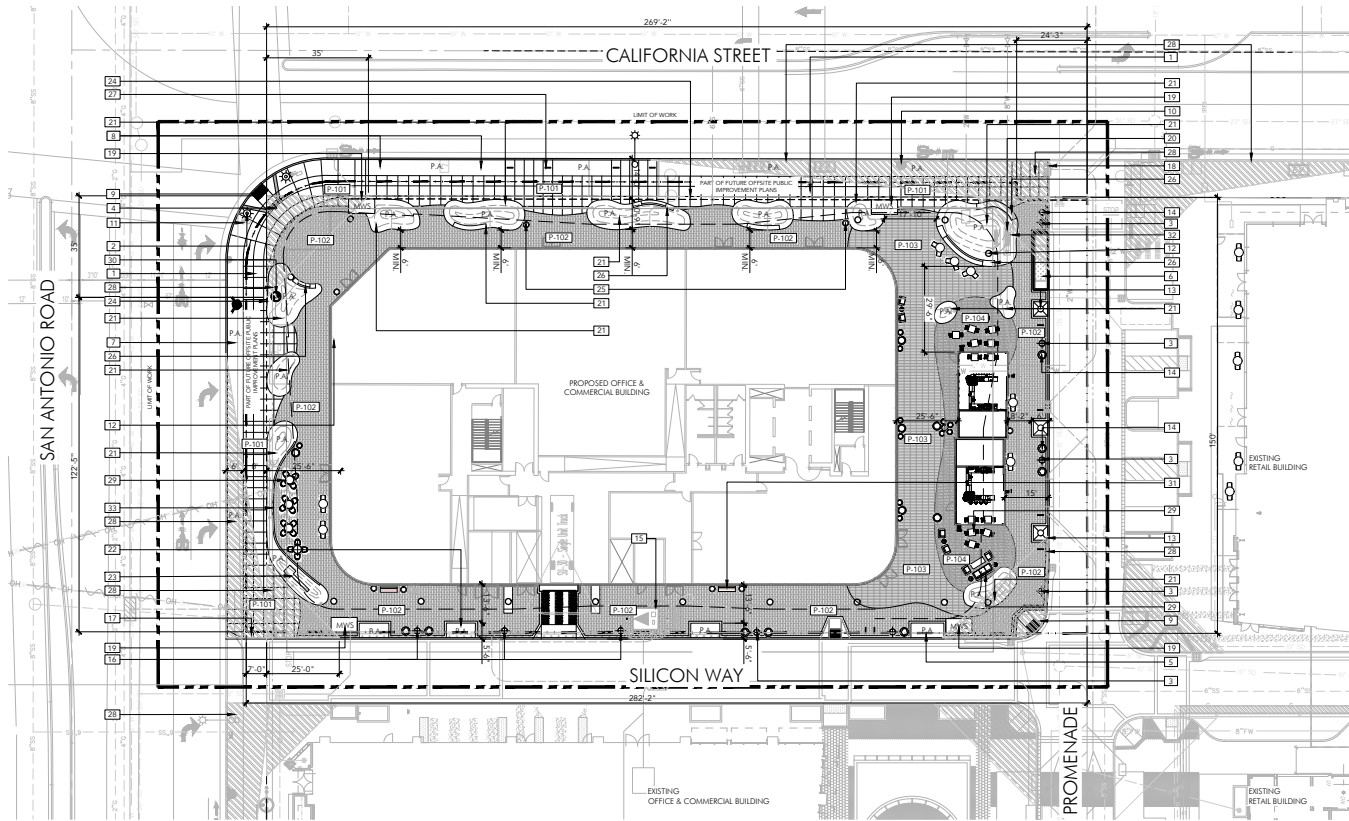

REFERENCE NOTES SCHEDULE

SYMBOL	DESCRIPTION	SYMBOL	DESCRIPTION
1	EXISTING R.O.W. SIDEWALK	17	MODULAR WETLAND VAULT SYSTEM; SEE CIVIL PLANS
2	EXISTING TRAFFIC LIGHT	20	FIRE BACKFLOW PREVENTER
3	EXISTING STREET LIGHT	21	LANDSCAPE PLANTER MOUNDS, SEE NOTE D
4	EXISTING CROSSWALK BUTTON	22	AT GRADE PLANTER, SEE DETAIL 11, SHEET L1.12
5	EXISTING SITE PLANTER	23	BUILDING SIGNAGE
6	EXISTING MODULAR WETLAND	24	UNDERGROUND PARKING LIMIT
7	EXISTING RIGHT OF WAY PLANTER AREA	25	TRASH RECEPTACLE MODEL: PD-MF3, COLOR TEXTURED BLACK, AVAILABLE FROM D.M. BRAUN, SEE DETAIL 8, SHEET L1.11
8	EXISTING DG TREE WELL TO BE REMOVED	26	CONCRETE SEATWALL WITH METAL BENCH TOP
9	EXISTING CROSSWALK ADA RAMP	27	27" METAL BICYCLE RACK, 2 STALLS PER RACK, RING STAINLESS STEEL BIKE RACK, IMBED MOUNT, AVAILABLE FROM LANDSCAPE FORMS, SEE DETAIL 2, SHEET L1.11
10	EXISTING FIRE HYDRANT	28	SIGHT TRIANGLE LINES, REFER TO NOTE D ON THIS SHEET FOR CLARIFICATION. - SEE CIVIL PLANS FOR LAYOUT AND DIMENSIONS
11	EXISTING UTILITIES	29	SITE FURNITURE, REFER TO DETAILS 8-10 SHEET L1.12 & NOTES ON THIS SHEET
12	BUILDING COLUMNS	30	SCULPTURAL LANDSCAPE ELEMENT
13	EXISTING METAL TREE GRATE - SEE DETAIL 1, SHEET L1.11	31	BENCH, SEE DETAIL 7, SHEET L1.11
14	EXISTING PLANTER POT, SEE DETAIL 5, SHEET L1.11	32	FDC 18" TALL SCREENED WITH PLANTING, REFER TO PLANTING SHEET L5.01
15	BUILDING ELECTRICAL TRANSFORMER	33	6" P.I.P. CONCRETE WALL, SEE DETAIL 13, SHEET L1.12
16	LIGHT FIXTURE/ BANNER POLE, "HW PATINA" POT TOP LIGHT FIXTURE WITH CUSTOM BANNER EXTENSIONS, SEE DETAIL 3, SHEET L1.11		
17	RAMP TO ZERO CURB		
18	ADA RAMP & SIGNAGE, SEE CIVIL PLANS		

PAVING SCHEDULE

SYMBOL	DESCRIPTION	MATERIAL	FINISH	PATTERN	COLOR
P-101	EXISTING NATURAL GRAY CONCRETE	CONCRETE	BROOM FINISH		
P-102	4 X 24 INTERLOCKING PAVER 8 CM DEPTH	CONC. PAVER	STANDARD FACE MIX SEAL PER SPECS	STAGGERED BOND	25% MOCHA, 25% AMARETTO, 25% CARMEL, 25% MAPLE
P-103	4 X 24 INTERLOCKING PAVER 8 CM DEPTH	CONC. PAVER	STANDARD FACE MIX SEAL PER SPECS	STACKED BOND	MOCHA
P-104	4 X 24 INTERLOCKING PAVER 8CM DEPTH	CONC. PAVER	BURNISHED / FLAT EDGE	STACKED BOND	CARMEL

NOTES:

- A. "OUTDOOR DINING FURNITURE IS SHOWN FOR ILLUSTRATIVE PURPOSES ONLY. FINAL OUTDOOR DINING FURNITURE SHALL BE BY TENANT UNDER SEPARATE PERMIT."
- B. REFER TO SHEET L1.02 FOR SITE AND BUILDING FLOORS OPEN SPACE PLANS AND CALCULATIONS
- C. FOR ALL SPOT ELEVATIONS AND GRADES SEE CIVIL ENGINEER'S CONCEPTUAL GRADING PLAN SHEET C3.01
- D. ALL LANDSCAPE MOUNDS ARE NOT TO EXCEED 3' IN HEIGHT TO ENSURE COMPLIANCE WITH ALL CITY OF MOUNTAIN VIEW SIGHT TRIANGLE AND CPTEED GUIDELINES.

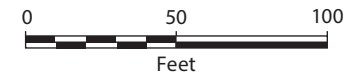

Source: Urban Arena, 2021.



Figure 2-7
Proposed Landscape Plan
San Antonio Phase III

2.5.5.4 Dry Utilities

The project proposes to construct new dry utility service connections. A 3-inch gas connection would be provided from San Antonio Road. All electrical and telecommunication utilities would be connected to existing electrical and telecommunication utilities in California Street.

2.5.5.5 Solid Waste

The City has contracted with Recology to provide residential and commercial waste and recycling services to all residents and businesses within the city. The project site would be served by Recology under this contract. In addition, there is a trash management plan already in place for all of Phase II, which would be amended to incorporate the project.

2.5.6 Transportation Demand Management

The project proposes the following Transportation Demand Management (TDM) measures and strategies, which are anticipated to reduce peak-hour traffic by approximately 30 percent. These measures include, but are not limited to:

- Providing secure, transit-oriented building entrances
- Enhancing transit stops, pedestrian crossings, and bicycle network through incorporation of shuttle stops and passenger loading zones, and supporting new bike signage, sharrows, and lanes
- Constructing secure bicycle parking
- Providing an onsite bicycle maintenance and repair station
- Implementing a Bicycle Share program;
- Installing onsite showers and locker rooms
- Creating onsite car share spaces
- Providing TDM information space
- Identifying or hiring a TDM coordinator
- Providing flexible work arrangements
- Providing a free ride or reimburse cost for emergency rides home
- Subsidizing transit, carshare, walking, and biking costs

2.6 Construction

As discussed above, two commercial buildings and associated surface parking lots would be demolished under the proposed project.

Construction of the project is scheduled to commence in February 2022 and end in May 2024, a period of approximately 28 months. The project would include the following construction phases: (1) demolition and clearing, (2) excavation, shoring, and grading, (3) foundation, (4) building structure and exterior systems, (5) site improvements, and (6) finishes. Dewatering could be

required during construction of the proposed building. All off-road diesel-powered equipment used during construction would be equipped with EPA-approved Tier 4 Final engines. Evidence regarding the use of Tier 4 Final engines or cleaner during project construction would be provided to the City by the project applicant or construction contractor.

Demolition would generate approximately 1,547 cubic yards of material, including trees, concrete, and asphalt. Construction of the below-grade parking garage and the foundation would require excavation work. The project would excavate to a maximum depth of approximately 55 feet below the ground surface, which would result in the export of approximately 55,350 cubic yards of soil. In total, demolition and excavation for the project would result in approximately 56,897 cubic yards of off-haul material.

Demolition debris, removed trees, concrete and asphalt, and materials from garage excavation and miscellaneous grading would be transported to either the Newby Island Landfill or Dumbarton Quarry. The haul route to the Newby Island Landfill or Dumbarton Quarry would involve heading north San Antonio Road, east on Old Middlefield Way, and then traveling southbound on U.S. 101. The haul route for trucks returning to the project site would be in the opposite direction.

2.6.1 Construction Hours

Project construction would comply with Section 8.70.1 of the City of Mountain View Municipal Code, which includes regulations related to noise generated by construction. It stipulates that no construction activity will commence prior to 7:00 a.m. or continue later than 6:00 p.m. Monday through Friday. In addition, no work will be permitted on Saturdays, Sundays, or holidays, unless the Chief Building Official grants prior written approval.

2.7 Required Permits and Approvals

Implementation of the project would require approvals from the City and other agencies. The approvals and entitlements anticipated for implementation of the project include:

- Precise Plan Amendment
- Master Plan Permit
- Development Agreement
- Development Review Permit
- Planned Community Permit
- Provisional Use Permit
- Lot Line Adjustment
- Heritage Tree Removal Permit

Organization of This Section

For each environmental topic, this analysis section provides a brief summary of impacts associated with implementation of the San Antonio Precise Plan (SAPP) as discussed in the Final SAPP Environmental Impact Report (EIR) certified on November 7, 2014. In addition, this section provides a discussion of the potential impacts under the proposed project. Because this addendum only addresses changes to a portion of the SAPP Plan Area, this document focuses on a comparison between the proposed project and the conclusions reached in the Final SAPP EIR. In instances where the Final SAPP EIR does not specifically describe the impacts from the proposed project, this document compares the impacts of the proposed project with the overall conclusions made regarding implementation of the SAPP. The project applicant is not seeking any other changes to the SAPP beyond the proposed project; therefore, no other components of the SAPP are explicitly discussed in this analysis.

Summary of Environmental Impacts

Table 3.0-1 summarizes the main conclusions of each environmental topic under both the SAPP EIR and the proposed project. As indicated in Table 3.0-1, all conclusions in the SAPP EIR would remain the same for the proposed project. Although some impacts would be slightly less than or slightly greater than those of the SAPP EIR, these changes would be minor and would not affect the significance conclusions in the Final EIR.

Topics Found to Have No Impact

Based on knowledge of the project site and surrounding areas, it was determined in the certified Final SAPP EIR that there would be no plan-related impacts on aesthetics, agriculture and forestry resources, mineral resources, or wildfire because these resources are not present in the Plan Area vicinity. The same conclusion of “no impact” applies to the proposed project.

Aesthetics

The SAPP EIR concluded that with adherence and implementation of the identified General Plan policies and actions and the SAPP Development Standards and Guidelines, the SAPP would result in less- than significant aesthetic impacts.

Due to the proposed project’s location within the SAPP area and other characteristics, the proposed project is deemed to have no impact, rather than a less than significant impact, on aesthetics. Public Resources Code (PRC) Section 21099, *Modernization of Transportation Analysis for Transit-Oriented Projects*, provides that impacts to aesthetics and parking will not be considered in determining if a project has the potential to result in significant environmental effects, provided the project meets the following criteria under PRC Section 21099:

- The project is on an infill site.
- The project is in a Transit Priority Area (TPA).
- The project is a residential, mixed-use residential, or employment-center project.

The proposed project meets the above criteria as a qualifying employment-center project for purposes of PRC Section 21099 and, therefore, aesthetics and vehicular parking are not further analyzed. The project site is a qualifying infill site that is currently developed with existing commercial and retail uses. The entire perimeter of the project site adjoins urban uses or public rights-of-way. The Metropolitan Transportation Commission (MTC) has identified locations of TPAs within the Bay Area (MTC 2017). MTC mapping indicates that the entire project site is within a TPA, due to its proximity to the Caltrain San Antonio Station. The project site is zoned San Antonio Precise Plan (P-40) under the City's Zoning Code. The proposed project would demolish all existing uses on the project site and construct an approximately 182,352 gross square foot (gsf) building with approximately 12,970 gsf of ground floor retail space and approximately 169,382 gsf of office space. The project would exceed the allowable FAR (2.35). Therefore, the proposed project qualifies as an employment center project.

Because the project meets the three criteria above, this addendum does not consider aesthetics or vehicular parking in determining the significance of impacts under CEQA.

Agriculture and Forestry Resources

The SAPP EIR concluded that implementation of the Plan would have no impact on agricultural or forestry resources, as the Plan Area is an urban developed area and not zoned for or used for agriculture or forestry purposes. In addition, the Plan Area is not designated by the Department of Conservation as farmland of any type, and is not subject to a Williamson Act contract. Further, no properties adjacent to the Plan Area are used or zoned for agriculture or forestry purposes.

As the proposed project is located within the Plan Area, the conclusions as they relate to impacts to agricultural and forestry resources have not changed, and the proposed project would result in no impacts to agriculture and forestry resources.

Mineral Resources

The SAPP EIR concluded that implementation of the Plan would not result in any impacts to mineral resources as the Plan Area is located in a developed urban area and mineral exploration and extraction are not performed in the vicinity. In addition, there are no minerals or aggregate resources of statewide importance located in the Plan Area as defined by the State of California mapping system. Since the proposed project is located within the Plan Area, the conclusions as they relate to impacts to mineral resources have not changed, and the proposed project would result in no impacts to mineral resources.

Wildfire

The SAPP EIR concluded that implementation of the Plan would result in less than significant impacts related to wildfire, as there are no Fire Hazard Severity Zones for State Responsibility areas or Very High Fire Hazard Severity Zones for local responsibility areas within or adjacent to the Plan Area according to the California Department of Forestry and Fire Protection (CAL FIRE)'s Fire

Hazard Severity Zone Maps. As the proposed project is located within the Plan Area, the conclusions as they relate to wildfire have not changed, and the proposed project would result in no impacts to wildfire.

Environmental Analysis

This section includes a summary of the findings in the certified Final SAPP EIR and explains why these impacts have not changed as a result of the proposed project.

Table 3.0-1. Comparison of SAPP EIR Impacts and Proposed Project Impacts

Environmental Issue	SAPP EIR	Proposed Project	Change in Impact
Air Quality	LTS/M	LTS/M	0
Biological Resources	LTS	LTS	0
Cultural Resources and Tribal Cultural Resources	LTS	LTS	0
Energy	LTS	LTS	0
Geology and Soils	LTS	LTS	0
Greenhouse Gas Emissions	LTS	LTS	0
Hazards and Hazardous Materials	LTS	LTS	0
Hydrology and Water Quality	LTS	LTS	0
Land Use and Planning	LTS	LTS	0
Noise	LTS/M	LTS/M	0
Population and Housing	LTS	LTS	0
Public Services and Recreation	LTS	LTS	0
Transportation and Traffic	LTS/M	LTS/M	0
Utilities and Service Systems	LTS/M	LTS/M	0

Applicable Mitigation Measures and Conditions of Approval

Table 3.0-2 identifies the SAPP EIR mitigation measures and City standard conditions of approval applicable to the proposed project. An update to the City standard conditions of approval became effective September 20, 2021; thus, the numbering and text of the conditions may have been revised subsequent to the preparation of the SAPP EIR. This addendum refers to the September 20, 2021, version of the City standard conditions of approval.

Table 3.0-2. Mitigation Measures and Conditions of Approval Summary Table

Environmental Issue	SAPP EIR Mitigation Measure or City Standard Condition of Approval Number	Full Text of SAPP EIR Mitigation Measure or City Standard Condition of Approval
SAPP EIR Mitigation Measures		
Air Quality	Mitigation Measure AIR-1	All new development projects, associated with implementation of the SA Precise Plan, which include buildings within 1,000 feet of a residential dwelling unit shall conduct a construction health risk assessment to assess emissions from all construction equipment during each phase of construction prior to issuance of building permits. Equipment usage shall be modified as necessary to ensure that equipment use would not result in a carcinogenic health risk of more than 10 in 1 million, an increased non-cancer risk of greater than 1.0 on the hazard index (chronic or acute), or an annual average ambient PM2.5 increase greater than 0.3 µg/m ³ .
Noise	Mitigation Measure NOISE-1	<p>The following language shall be included as a Condition of Approval for new projects associated with implementation of the SA Precise Plan:</p> <ul style="list-style-type: none"> • In the event that pile driving would be required for any proposed project within the SA Precise Plan area, all residents within 300 feet of the project site shall be notified of the schedule for its use a minimum of one week prior to its commencement. The contractor shall implement “quiet” pile driving technology (such as pre-drilling of piles, the use of more than one pile driver to shorten the total pile driving duration, or the use of portable acoustical barriers) where feasible, in consideration of geotechnical and structural requirements and conditions. • To the extent feasible, the project contractor shall phase high-vibration generating construction activities, such as pile-driving/ground-impacting operations, so they do not occur in the same period with demolition and excavation activities in locations where the combined vibrations would potentially impact sensitive areas. • The project contractor shall select demolition methods not involving impact, where possible (for example, milling generates lower vibration levels than excavation using clam shell or chisel drops). • The project contractor shall avoid using vibratory rollers and packers near sensitive areas whenever possible.
Transportation and Traffic	Mitigation Measure TRANS-1	Add a right turn overlap phase at Intersection #17, San Antonio Road/California Avenue for the westbound right turn movement, or comparable improvement to maintain acceptable intersection LOS.

Environmental Issue	SAPP EIR Mitigation Measure or City Standard Condition of Approval Number	Full Text of SAPP EIR Mitigation Measure or City Standard Condition of Approval
Utilities and Services	Mitigation Measure UTL-1	As private properties within the Plan area are developed, project-specific capacity and condition analyses of applicable water infrastructure adjacent and downstream of the project sites shall be performed to identify any impacts to the water system. As a condition of approval and prior to issuance of grading and/or building permits, the Public Works Department will determine and assign responsibility to project applicants for upgrades and improvements to the City’s water infrastructure, as necessary.
Utilities and Services	Mitigation Measure UTL-2	As private properties within the Plan area are developed, project-specific capacity and condition analyses of applicable wastewater infrastructure adjacent and downstream of the project sites shall be performed to identify any impacts to the wastewater system. As a condition of approval and prior to issuance of grading and/or building permits, the Public Works Department will determine and assign responsibility to project applicants for upgrades and improvements to the City’s wastewater infrastructure, as necessary.
Utilities and Services	Mitigation Measure UTL-3	As private properties within the Plan area are developed, project-specific analyses of stormwater infrastructure adjacent and downstream of the project sites shall be performed to identify any impacts to the system. As a condition of approval and prior to issuance of grading and/or building permits, the Public Works Department will determine and assign responsibility to project applicants for upgrades and improvements to the City’s stormwater infrastructure, as necessary.
City Standard Conditions of Approval		
Hazards and Hazardous Materials	COA BID-15 Hazardous Materials	Any installation of hazardous materials will require submittal of HMIS forms for the Fire Protection Engineer and the Hazardous Materials Specialist. Please visit City of Mountain View—Fire & Environmental Protection Division online at www.mountainview.gov/fep or by phone at 650-903-6378 to obtain information and submittal requirements.
Public Services and Recreation	COA BID-44 School Impact Fee	Project is subject to school impact fees. To obtain information, fee estimates, and procedures, please contact the following local school districts: Mountain View Los Altos High School District at www.mvla.net or 650-940-4650; and Mountain View Whisman School District at www.mvwsd.org or 650-526-3500; or Los Altos Elementary School District at www.lasdschools.org or 650-947-1150.
Public Services and Recreation	COA FD-43 Emergency Response Radio Coverage	All buildings shall have approved radio coverage for emergency responders within the building. (California Fire Code, Section 510.)
Geology and Soils	COA FEP-03 State of California Construction General Stormwater Permit	A “Notice of Intent” (NOI) and “Stormwater Pollution Prevention Plan” (SWPPP) shall be prepared for construction projects disturbing one (1) acre or more of land. Proof of coverage under the State General Construction Activity Stormwater Permit shall be attached to the building plans.

Environmental Issue	SAPP EIR Mitigation Measure or City Standard Condition of Approval Number	Full Text of SAPP EIR Mitigation Measure or City Standard Condition of Approval
Geology and Soils	COA FEP-04 Construction Best Management Practices	All construction projects shall be conducted in a manner which prevents the release of hazardous materials, hazardous waste, polluted water, and sediments to the storm drain system. Refer to the City of Mountain View document, "It's In the Contract But Not In the Bay," for the specific construction practices required at the job site.
Biological Resources; Geology and Soils; Hydrology and Water Quality	COA FEP-05 Construction Sediment and Erosion Control Plan	The applicant shall submit a written plan acceptable to the City which shows controls that will be used at the site to minimize sediment runoff and erosion during storm events. The plan should include installation of the following items where appropriate: (a) silt fences around the site perimeter; (b) gravel bags surrounding catch basins; (c) filter fabric over catch basins; (d) covering of exposed stockpiles; (e) concrete washout areas; (f) stabilized rock/gravel driveways at points of egress from the site; and (g) vegetation, hydroseeding, or other soil stabilization methods for high-erosion areas. The plan should also include routine street sweeping and storm drain catch basin cleaning.
Biological Resources; Hydrology and Water Quality	COA FEP-22 Stormwater Treatment (C.3)	<p>This project will create or replace more than ten thousand (10,000) square feet of impervious surface; therefore, stormwater runoff shall be directed to approved permanent treatment controls as described in the City's guidance document entitled, "Stormwater Quality Guidelines for Development Projects." The City's guidelines also describe the requirement to select Low-Impact Development (LID) types of stormwater treatment controls; the types of projects that are exempt from this requirement; and the Infeasibility and Special Projects exemptions from the LID requirement.</p> <p>The "Stormwater Quality Guidelines for Development Projects" document requires applicants to submit a Stormwater Management Plan, including information such as the type, location, and sizing calculations of the treatment controls that will be installed. Include three stamped and signed copies of the Final Stormwater Management Plan with the building plan submittal. The Stormwater Management Plan must include a stamped and signed certification by a qualified Engineer, stating that the Stormwater Management Plan complies with the City's guidelines and the State NPDES Permit. Stormwater treatment controls required under this condition may be required to enter into a formal recorded Maintenance Agreement with the City.</p>
Hazards and Hazardous Materials	COA HAZ-02 Hazardous Materials	If hazardous materials will be stored or used on-site (including paints, thinners, compressed gases, propane, diesel, gasoline, etc.), complete an Environmental Compliance Plan (ECP) application. Attach a copy of the completed ECP to your building plan submittal.
Hazards and Hazardous Materials	COA HAZ-03 Installation or Upgrade of Hazardous Materials Storage	"Installation or Upgrade of Hazardous Materials Storage or Use Areas" check sheet. All applicable items in the check sheet should be completed and shown on the building plan submittal.

Environmental Issue	SAPP EIR Mitigation Measure or City Standard Condition of Approval Number	Full Text of SAPP EIR Mitigation Measure or City Standard Condition of Approval
Hazards and Hazardous Materials	COA PL-49 Toxic Assessment	A toxic assessment report shall be prepared and submitted as part of the building permit submittal. The applicant must demonstrate that hazardous materials do not exist on the site or that construction activities and the proposed use of this site are approved by: the City' Fire Department (Fire and Environmental Protection Division); the State Department of Health Services; the Regional Water Quality Control Board; and any Federal agency with jurisdiction. No building permits will be issued until each agency and/or department with jurisdiction has released the site as clean or a site toxics mitigation plan has been approved.
Noise	COA PL-149 Mechanical Equipment	The noise emitted by any mechanical equipment shall not exceed a level of 55 dB during the day or 50 dB during the night, 10:00 p.m. to 7:00 a.m., when measured at any location on the adjoining residentially used property.
Noise	COA PL-150 Noise Generation	All noise-generating activities (i.e., entertainment or amplified sound) are limited to interior areas only, and the heating, ventilation, and air conditioning system shall be maintained to ensure that all windows and doors can remain closed when the restaurant is in operation.
Noise	COA PL-152 Construction Noise Reduction	The following noise reduction measures shall be incorporated into construction plans and contractor specifications to reduce the impact of temporary construction-related noise on nearby properties: (a) comply with manufacturer's muffler requirements on all construction equipment engines; (b) turn off construction equipment when not in use, where applicable; (c) locate stationary equipment as far as practical from receiving properties; (d) use temporary sound barriers or sound curtains around loud stationary equipment if the other noise reduction methods are not effective or possible; and (e) shroud or shield impact tools and use electric-powered rather than diesel-powered construction equipment.
Noise	COA PL-186 Work Hours	No work shall commence on the job site prior to 7:00 a.m. nor continue later than 6:00 p.m., Monday through Friday, nor shall any work be permitted on Saturday or Sunday unless prior approval is granted by the Chief Building Official. At the discretion of the Chief Building Official, the general contractor or the developer may be required to erect a sign at a prominent location on the construction site to advise subcontractor and material suppliers of the working hours. Violation of this condition of approval may be subject to the penalties outlined in Section 8.6 of the City Code and/or suspension of building permits.
Noise	COA PL-188 Notice of Construction	The applicant shall notify neighbors within 750 feet of the project site of the construction schedule in writing, prior to construction. A copy of the notice and the mailing list shall be submitted prior to issuance of building permits.

Environmental Issue	SAPP EIR Mitigation Measure or City Standard Condition of Approval Number	Full Text of SAPP EIR Mitigation Measure or City Standard Condition of Approval
Noise	COA PL-189 Disturbance Coordinator	The project applicant shall designate a “disturbance coordinator” who will be responsible for responding to any local complaints regarding construction noise. The coordinator (who may be an employee of the general contractor) will determine the cause of the complaint and will require that reasonable measures warranted to correct the problem be implemented. A telephone number of the noise disturbance coordinator shall be conspicuously posted at the construction site fence and on the notification sent to neighbors adjacent to the site.
Air Quality	COA PL-192 Basic Air Quality Construction Measures	The applicant shall require all construction contractors to implement the basic construction mitigation measures recommended by the Bay Area Air Quality Management District (BAAQMD) to reduce fugitive dust emissions. Emission reduction measures will include, at a minimum, the following measures. Additional measures may be identified by the BAAQMD or contractor as appropriate, such as: (a) all exposed surfaces (e.g., parking areas, staging areas, soil piles, graded areas, and unpaved access roads) will be watered two times per day; (b) all haul trucks transporting soil, sand, or other loose material off-site will be covered; (c) all visible mud or dirt track-out onto adjacent public roads will be removed using wet power vacuum street sweepers at least once per day. The use of dry power sweeping is prohibited; (d) all vehicle speeds on unpaved roads will be limited to 15 mph; (e) all roadways, driveways, and sidewalks to be paved will be completed as soon as possible. Building pads will be laid as soon as possible after grading unless seeding or soil binders are used; and (f) post a publicly visible sign with the telephone number and person to contact at the lead agency regarding dust complaints. This person will respond and take corrective action within 48 hours. The BAAQMD’s phone number will also be visible to ensure compliance with applicable regulations.
Geology and Soils	COA PL-48 Geotechnical Report	The applicant shall have a design-level geotechnical investigation prepared which includes recommendations to address and mitigate geologic hazards in accordance with the specifications of CGS Special Publication 117, Guidelines for Evaluating and Mitigating Seismic Hazards, and the requirements of the Seismic Hazards Mapping Act.
Biological Resources	COA PL-134 Arborist Inspections	During demolition activity and upon demolition completion, a qualified arborist shall inspect and verify the measures described in the arborist report are appropriately implemented for construction activity near and around the preserved trees, including the critical root zones. Should it be determined that the root systems are more extensive than previously identified and/or concerns are raised of nearby excavation or construction activities for the project foundation or underground parking garage, the design of the building and/or parking garage may need to be altered to maintain the health of the trees prior to building permit issuance.

Environmental Issue	SAPP EIR Mitigation Measure or City Standard Condition of Approval Number	Full Text of SAPP EIR Mitigation Measure or City Standard Condition of Approval
Biological Resources	COA PL-135 Monthly Arborist Inspections	Throughout demolition and construction, a qualified arborist must conduct monthly inspections to ensure tree protection measures and maintenance care are provided. A copy of the inspection letter, including recommendations for modifications to tree care or construction activity to maintain tree health, shall be provided to the Planning Division at planning.division@mountainview.gov .
Biological Resources	COA PL-139 Replacement Trees	The applicant shall offset the loss of each Heritage/street tree with _____ replacement trees, for a total of _____ replacement trees. Each replacement tree shall be no smaller than a 24" box and shall be noted on the landscape plan as Heritage or street replacement trees.
Biological Resources	COA PL-141 Street Tree Protections	All designated City street trees are to be protected throughout construction activity with protection measures shown on building permit plans.
Biological Resources	COA PL-142 Tree Protection Measures	The tree protection measures listed in the arborist’s report prepared by _____ and dated _____ shall be included as notes on the title sheet of all grading and landscape plans. These measures shall include, but may not be limited to, 6’ chain link fencing at the drip line, a continuous maintenance and care program, and protective grading techniques. Also, no materials may be stored within the drip line of any tree on the project site.
Biological Resources	COA PL-143 Security Bond	The applicant shall post a security bond to ensure that replacement trees are planted and become established (one year after planting) and to compensate for the trees that were lost due to illegal removal.
Biological Resources	COA PL-198 Preconstruction Nesting Bird Survey	To the extent practicable, vegetation removal and construction activities shall be performed from September 1 through January 31 to avoid the general nesting period for birds. If construction or vegetation removal cannot be performed during this period, preconstruction surveys will be performed no more than two days prior to construction activities to locate any active nests as follows: The applicant shall be responsible for the retention of a qualified biologist to conduct a survey of the project site and surrounding 500’ for active nests—with particular emphasis on nests of migratory birds—if construction (including site preparation) will begin during the bird nesting season, from February 1 through August 31. If active nests are observed on either the project site or the surrounding area, the applicant, in coordination with the appropriate City staff, shall establish no-disturbance buffer zones around the nests, with the size to be determined in consultation with the California Department of Fish and Wildlife (usually 100’ for perching birds and 300’ for raptors). The no-disturbance buffer will remain in place until the biologist determines the nest is no longer active or the nesting season ends. If construction ceases for two days or more and then resumes during the nesting season, an additional survey will be necessary to avoid impacts on active bird nests that may be present.

Environmental Issue	SAPP EIR Mitigation Measure or City Standard Condition of Approval Number	Full Text of SAPP EIR Mitigation Measure or City Standard Condition of Approval
Hazards and Hazardous Materials	COA PL-193 Discovery of Contaminated Soils	If contaminated soils are discovered, the applicant will ensure the contractor employs engineering controls and Best Management Practices (BMPs) to minimize human exposure to potential contaminants. Engineering controls and construction BMPs will include, but not be limited to, the following: (a) contractor employees working on-site will be certified in OSHA's 40-hour Hazardous Waste Operations and Emergency Response (HAZWOPER) training; (b) contractor will stockpile soil during redevelopment activities to allow for proper characterization and evaluation of disposal options; (c) contractor will monitor area around construction site for fugitive vapor emissions with appropriate field screening instrumentation; (d) contractor will water/mist soil as it is being excavated and loaded onto transportation trucks; (e) contractor will place any stockpiled soil in areas shielded from prevailing winds; and (f) contractor will cover the bottom of excavated areas with sheeting when work is not being performed.
Cultural Resources	COA PL-194 Discovery of Archaeology Resources	If prehistoric or historic-period cultural materials are unearthed during ground-disturbing activities, it is recommended that all work within 100' of the find be halted until a qualified archaeologist and Native American representative can assess the significance of the find. Prehistoric materials might include obsidian and chert-flaked stone tools (e.g., projectile points, knives, scrapers) or tool-making debris; culturally darkened soil ("midden") containing heat-affected rocks and artifacts; stone milling equipment (e.g., mortars, pestles, handstones, or milling slabs); and battered-stone tools, such as hammerstones and pitted stones. Historic-period materials might include stone, concrete, or adobe footings and walls; filled wells or privies; and deposits of metal, glass, and/or ceramic refuse. If the find is determined to be potentially significant, the archaeologist, in consultation with the Native American representative, will develop a treatment plan that could include site avoidance, capping, or data recovery.

Environmental Issue	SAPP EIR Mitigation Measure or City Standard Condition of Approval Number	Full Text of SAPP EIR Mitigation Measure or City Standard Condition of Approval
Cultural Resources	COA PL-195 Discovery of Human Remains	In the event of the discovery of human remains during construction or demolition, there shall be no further excavation or disturbance of the site within a 50’ radius of the location of such discovery, or any nearby area reasonably suspected to overlie adjacent remains. The Santa Clara County Coroner shall be notified and shall make a determination as to whether the remains are Native American. If the Coroner determines that the remains are not subject to his/her authority, he/she shall notify the Native American Heritage Commission, which shall attempt to identify descendants of the deceased Native American. If no satisfactory agreement can be reached as to the disposition of the remains pursuant to this State law, then the landowner shall reinter the human remains and items associated with Native American burials on the property in a location not subject to further subsurface disturbance. A final report shall be submitted to the City’s Community Development Director prior to release of a Certificate of Occupancy. This report shall contain a description of the mitigation programs and its results, including a description of the monitoring and testing resources analysis methodology and conclusions, and a description of the disposition/curation of the resources. The report shall verify completion of the mitigation program to the satisfaction of the City’s Community Development Director.
Transportation and Traffic	COA PW-36 Traffic Control Plans	Upon submittal of the initial building permit and improvement plans, the applicant shall submit traffic control plans for any off-site and on-site improvements or any work that requires temporary lane closure, shoulder closure, bike lane closure, and/or sidewalk closure for review and approval. Sidewalk closures are not allowed unless reconstruction of sidewalk necessitates temporary sidewalk closure. In these instances, sidewalk detour should be shown on the Traffic Control plans. Traffic control plans shall be prepared in accordance with the latest edition of the California Manual of Uniform Traffic Control Devices (CA MUTCD).
Transportation and Traffic	COA PW-44 Corner Street Sight Triangle	At street corners of controlled and/or uncontrolled intersections, signs, fences, shrubs, bushes or hedges shall not exceed over 3’ in height while tree canopies shall maintain a minimum 6’ vertical clearance within traffic safety sight triangle formed by measuring 35’ along the front and side property lines.
Transportation and Traffic	COA PW-45 Driveway [or Side Street] Sight Triangle	Within the pedestrian and/or vehicle traffic safety sight triangle(s), signs, fences, shrubs, bushes or hedges shall not exceed 3’ in height while tree canopies shall maintain a minimum 6’ vertical clearance at the driveway location.
Utilities and Services	COA PW-128 Mountain View Green Building Code/Construction and Demolition Ordinance	If this project is subject to the requirements of the Mountain View Green Building Code, a Construction and Demolition Waste Management Plan shall be submitted with the building permit application and approved by the Solid Waste and Recycling Section prior to issuance of a building permit. A Final Construction and Demolition Waste Management Plan shall be submitted and approved prior to final inspection.

Environmental Issue	SAPP EIR Mitigation Measure or City Standard Condition of Approval Number	Full Text of SAPP EIR Mitigation Measure or City Standard Condition of Approval
Public Services and Recreation; Transportation and Traffic	COA PW-135 Construction Management Plans	<p>Upon submittal of the initial building permit and all subsequent building permit submittals, the applicant shall provide a construction traffic and parking management plan with the building plans showing the following:</p> <ol style="list-style-type: none"> 1. Truck Route: Truck route (to and from project site) for construction and delivery trucks pursuant to City Code Sections 19.58 and 19.59 and which does not include neighborhood residential streets; [OPTIONAL: The use of _____ [enter STREET NAME] shall be minimized]; 2. Construction Phasing, Equipment, Storage, and Parking: Show construction vehicles and equipment parking area, material storage and lay-down area, and construction trailer location for each phase of construction. All construction vehicles/equipment and trailer shall be located on-site or at a site nearby (not on a public street or public parking) arranged by the permittee/contractor. Construction equipment, materials, or vehicles shall not be stored or parked on public streets or public parking lots. Construction contractors/workers are required to park on-site or at a private property arranged by the permittee/contractor and shall not be allowed to use neighboring streets for parking/storage; and 3. Sidewalk closure or narrowing is not allowed during any on-site construction activities. <p>The construction traffic and parking management plan must be approved prior to the issuance of a demolition permit.</p>

	Did the Program EIR Identify a Significant Impact and Mitigation Measures?	Do Program EIR Mitigation Measures Apply to the Project?	Does New Information of Substantial Importance Require Preparation of a Supplemental Subsequent EIR?	Is There No New Information of Importance Requiring Preparation of a Supplemental/ Subsequent EIR?
I. Air Quality				
Would the project:				
a. Conflict with or obstruct implementation of the applicable air quality plan?	<input type="checkbox"/>	<input type="checkbox"/>	<input type="checkbox"/>	<input checked="" type="checkbox"/>
b. Result in a cumulatively considerable net increase in any criteria pollutant for which the project region is in non-attainment status under an applicable federal or state ambient air quality standard?	<input type="checkbox"/>	<input type="checkbox"/>	<input type="checkbox"/>	<input checked="" type="checkbox"/>
c. Expose sensitive receptors to substantial pollutant concentrations?	<input checked="" type="checkbox"/>	<input checked="" type="checkbox"/>	<input type="checkbox"/>	<input checked="" type="checkbox"/>
d. Result in other emissions (such as those leading to odors) that would adversely affect a substantial number of people?	<input type="checkbox"/>	<input type="checkbox"/>	<input type="checkbox"/>	<input checked="" type="checkbox"/>

Note: A checked box indicates a “yes” answer.

3.1 Air Quality

The U.S. Environmental Protection Agency (EPA) has established National Ambient Air Quality Standards (NAAQS) for six criteria air pollutants that are known to be harmful to human health and the environment, carbon monoxide (CO); lead; nitrogen dioxide (NO₂); ozone; particulate matter, which is categorized as respirable particulate matter with an aerodynamic diameter less than or equal to 10 microns (PM₁₀) and fine particulate matter with an aerodynamic diameter less than or equal to 2.5 microns (PM_{2.5}); and sulfur dioxide (SO₂). The California Air Resources Board (CARB) established the California Ambient Air Quality Standards (CAAQS) for these six pollutants as well as sulfates, hydrogen sulfide, vinyl chloride, and visibility-reducing particles. The NAAQS and CAAQS represent scientifically substantiated numerical concentrations of criteria air pollutants. The standards have been established to protect the public from adverse health impacts caused by exposure to air pollution. A brief description of the criteria air pollutants, as well as their effects on health, is provided in Table 3.1-1.

The project site is in Santa Clara County. It is also within the San Francisco Bay Area Air Basin (SFBAAB). This large, shallow air basin is ringed by hills that taper into a number of sheltered valleys around the perimeter. The SFBAAB has two primary atmospheric outlets. One is the strait known as the Golden Gate, a direct outlet to the Pacific Ocean. The other primary outlet extends to the northeast, along the West Delta region of the Sacramento and San Joaquin Rivers.

The SFBAAB is currently designated as a non-attainment area with respect to the NAAQS and CAAQS for ozone, the CAAQS for PM₁₀, and the CAAQS for PM_{2.5}. The SFBAAB is designated as attainment unclassifiable with respect to the NAAQS and CAAQS for all other criteria air pollutants.¹

¹ California Air Resources Board. 2020. *State Area Designations*. Appendix C: Maps and Tables of Area Designations for State and National Ambient Air Quality Standards. October. Available: <https://ww3.arb.ca.gov/regact/2021/sad20/appc.pdf>. Accessed: April 16, 2021.

Table 3.1-1. Criteria Air Pollutants

Pollutant	Sources	Effects
Ozone	Ozone is a secondary air pollutant. It is produced in the atmosphere through a complex series of photochemical reactions involving reactive organic gases (ROGs), sometimes referred to as volatile organic compounds by some regulating agencies, and nitrogen oxides (NO _x). The main sources of ROGs and NO _x , which are referred to as ozone precursors, are by-products of combustion processes, including exhaust from motor vehicle engines, and evaporation involving solvents, paints, and fuels.	Ozone causes eye irritation, airway constriction, and shortness of breath and can aggravate existing respiratory diseases, such as asthma, bronchitis, and emphysema.
Carbon monoxide	Carbon monoxide (CO) is usually formed as the result of the incomplete combustion of fuel. The single largest source of CO is motor vehicle engines. The highest emissions occur during low travel speeds, stop-and-go driving, cold starts, and hard acceleration.	Exposure to high concentrations of CO reduces the oxygen-carrying capacity of the blood. It can cause headaches, nausea, dizziness, and fatigue; impair central nervous system functions; and induce angina (chest pain) in persons with serious heart disease. Very high levels of CO can be fatal.
Particulate matter	Some sources of particulate matter, such as wood burning in fireplaces, demolition, and construction activities, are more local in nature, while others, such as vehicular traffic, have a more regional effect.	Scientific studies have suggested links between fine particulate matter and numerous health problems, including asthma, bronchitis, and acute and chronic respiratory symptoms, such as shortness of breath and painful breathing. Recent studies have shown an association between morbidity and mortality and the daily concentrations of particulate matter in the air.
Nitrogen dioxide	NO ₂ is a reddish-brown gas. It is a by-product of combustion processes. Automobiles and industrial operations are the main sources of NO ₂ .	Aside from its contribution to ozone formation, NO ₂ can increase the risk of acute and chronic respiratory disease and reduce visibility.
Sulfur dioxide	Sulfur dioxide (SO ₂) is a by-product of combustion involving sulfur or sulfur-containing fuels, such as coal and diesel.	SO ₂ is also a precursor to the formation of particulate matter, atmospheric sulfate, and atmospheric sulfuric acid formation that could precipitate downwind as acid rain.
Lead	Leaded gasoline, lead-based paint, smelters (metal refineries), and manufacturers of lead storage batteries have been the primary sources of the lead that gets released into the atmosphere. Lead levels in the air decreased substantially after leaded gasoline was eliminated in the United States.	Lead has a range of adverse neurotoxic health effects.

Source: EPA. 2021. *Criteria Air Pollutants*. Available: <https://www.epa.gov/criteria-air-pollutants>. Accessed: May 1, 2021; CARB. 2021. *Common Air Pollutants*. Available: <https://ww2.arb.ca.gov/resources/common-air-pollutants>. Accessed: April 25, 2021.

Notes:

CO = carbon monoxide; NO₂ = nitrogen dioxide; NO_x = nitrogen oxides; ROG = reactive organic gases; SO₂ = sulfur dioxide.

The Bay Area Air Quality Management District (BAAQMD) is the local agency responsible for air quality planning and the development of air quality plans in the SFBAAB. BAAQMD develops and implements its Clean Air Plan for attaining the NAAQS and CAAQS while accounting for future growth in the SFBAAB. The Clean Air Plan was last updated and approved by BAAQMD's Board of Directors and CARB in 2017.² BAAQMD also develops regulations and emission reduction programs to control emissions of criteria air pollutants and precursors, toxic air contaminants (TACs), and odors within its jurisdiction.

EPA and CARB also regulate air toxics. EPA refers to this category of pollutants as hazardous air pollutants (HAPs); CARB refers to them as TACs. This report uses TACs. TACs are a defined set of airborne pollutants that may cause or contribute to an increase in mortality or serious illness or pose a hazard to human health. TACs are usually present in minute quantities in the ambient air; however, their high toxicity or health risk may pose a threat to public health, even at low concentrations. A wide range of sources, from industrial plants to motor vehicles, emit TACs. The health effects associated with TACs are quite diverse and generally assessed locally rather than regionally. TACs can cause long-term health effects, such as cancer, birth defects, neurological damage, asthma, bronchitis, or genetic damage, or short-term acute effects, such as watery eyes, respiratory irritation (a cough), a running nose, throat pain, or headaches.

BAAQMD published its *California Environmental Quality Act Air Quality Guidelines* in 2017 to assist lead agencies in the evaluation of the air quality impacts of projects as well as plans proposed within the SFBAAB.³ The guidelines recommend procedures for evaluating potential impacts on air quality during the environmental review process, consistent with California Environmental Quality Act (CEQA) requirements. The guidelines also include background information about air quality in the SFBAAB; recommended methods for analyzing a project's criteria air pollutants and precursors, TACs, and odorous emissions; thresholds of significance for determining whether project-generated emissions would result in impacts on air quality and adverse effects on human health; and mitigation measures to reduce impacts on air quality. This guidance is employed below to assess the project's potential impact on air quality.

a. *Would the project conflict with or obstruct implementation of the applicable air quality plan?*

The SAPP EIR evaluated whether implementation of the SAPP would be consistent with BAAQMD's 2010 Clean Air Plan. As explained in the SAPP EIR, the 2010 Clean Air Plan was BAAQMD's comprehensive plan to improve air quality and protect public health in the San Francisco Bay Area. The design and development standards in the SAPP are consistent with the 2010 Clean Air Plan because they promote mixed-use, compact development to reduce motor vehicle travel and associated emissions; encourage the use of transit (e.g., by locating diverse high-density development near the San Antonio Caltrain station); improve pedestrian and bicycle connections, crossings, and facilities; promote improved connectivity for all travel modes to adjacent neighborhoods and downtown; and enable visitors who arrive by car to park once and walk to multiple destinations. For these reasons, the SAPP EIR concluded that implementation of

² Bay Area Air Quality Management District. 2017. *2017 Clean Air Plan: Spare the Air, Cool the Climate*. April 19. Available: https://www.baaqmd.gov/~media/files/planning-and-research/plans/2017-clean-air-plan/attachment-a_proposed-final-cap-vol-1-pdf.pdf?la=en or <https://www.baaqmd.gov/plans-and-climate/air-quality-plans/current-plans>. Accessed: September 15, 2021.

³ Bay Area Air Quality Management District. 2017. *California Environmental Quality Act Air Quality Guidelines*. May. Available: https://www.baaqmd.gov/~media/files/planning-and-research/ceqa/ceqa_guidelines_may2017-pdf.pdf?la=en. Accessed: September 15, 2021.

the SAPP would not conflict with the transportation control measures or the energy and climate control measures outlined in the 2010 Clean Air Plan. Therefore, the SAPP EIR concluded that this impact would be less than significant.

The types of land uses and associated emission sources developed by the proposed project would be the same as those analyzed in the SAPP EIR.

Subsequent to adoption of the SAPP EIR by the City of Mountain View (City) in 2014, BAAQMD adopted its 2017 Clean Air Plan, which replaced the 2010 Clean Air Plan. The 2017 Clean Air Plan generally contains the same control measures as the 2010 Clean Air Plan; it also contains some additional rules adopted since 2010. Most of the new rules apply to industrial sources, which would not be part of the land uses developed under the SAPP or by the proposed project. One new transportation control measure adopted by BAAQMD, Rule 14-1, implements the Bay Area Commuter Benefits Program. It requires employers with 50 or more Bay Area employees to provide commuter benefits to encourage ridesharing, using transit, cycling, and walking for work-related trips. As an adopted rule, this new measure would apply to all future employment-related land uses developed under the SAPP, including the new land uses developed as part of the proposed project. Moreover, the proposed project would be in compliance with other applicable measures in the 2017 Clean Air Plan by increasing land use density in the Mixed-Use Center Subarea of the SAPP, locating job-generating uses close to the San Antonio Caltrain station, improving bicycle and pedestrian connections around the site, providing Type I and Type II bicycle parking and bicycle storage on-site as well as pedestrian amenities consistent with requirements in the California Green Building Standards Code, and including electric-vehicle charging infrastructure. Therefore, the proposed project would not conflict or obstruct with implementation of an air quality plan. This impact would be *less than significant*. The proposed project would not result in new significant impacts or a substantial increase in the severity of impacts regarding the project's consistency with BAAQMD's air quality planning efforts that were analyzed in the SAPP EIR.

b. Would the project result in a cumulatively considerable net increase in any criteria pollutant for which the project region is in non-attainment status under an applicable federal or state ambient air quality standard?

As discussed above, EPA and CARB established the NAAQS and CAAQS, respectively, to protect the public from adverse health impacts associated with exposure to high concentrations of criteria air pollutants. Also discussed above, the SFBAAB is currently designated as a non-attainment area with respect to the NAAQS and CAAQS for ozone, the CAAQS for PM₁₀, and the CAAQS for PM_{2.5}.⁴ Separate discussions about emissions of criteria air pollutants and precursors emitted during project construction and operation are provided below.

Construction-Generated Emissions of Criteria Air Pollutants and Precursors

The SAPP EIR states that emissions of criteria air pollutants and precursors generated by construction activities under the SAPP would not result in an exceedance of any NAAQS or CAAQS because all construction projects would be required to implement City Standard Condition of Approval (COA) PL-192, which requires implementation of BAAQMD's Basic Construction Mitigation Measures to reduce fugitive dust emissions. The types of emissions-generating activities that would

⁴ California Air Resources Board. 2020. *State Area Designations*. Appendix C: Maps and Tables of Area Designations for State and National Ambient Air Quality Standards. October. Available: <https://ww3.arb.ca.gov/regact/2021/sad20/appc.pdf>. Accessed: April 16, 2021.

occur during construction of the proposed project would be similar to those analyzed in the SAPP EIR. Such emissions-generating activities may include trips made by commuting workers as well as the use of heavy-duty construction equipment, the use of haul trucks to transport materials and equipment to and from the site, and the application of architectural coatings. City Standard COA PL-192 would also require the proposed project to implement BAAQMD's basic construction mitigation measures to reduce fugitive dust emissions.

In addition to fugitive dust, construction activities would result in emissions of criteria air pollutants from the use of off- and on-road vehicles and equipment. The air district provides screening-level sizes for land use projects in Table 3-1 of its CEQA Guidelines.⁵ It can be assumed that projects that meet the screening criteria in the air district's CEQA Guidelines would not result in the generation of construction-related criteria air pollutants and/or precursors that would exceed thresholds of significance. Other screening criteria are discussed in Section 3.5.1 of the air district's CEQA Guidelines. The criteria specify that projects that would not require demolition activity, projects that would not require the simultaneous occurrence of more than two construction phases, and projects that would not involve extensive site preparation or extensive material transport operations (e.g., involving more than 10,000 cubic yards of soil import/export) would result in a less-than-significant impact. If a project meets the criteria, then a detailed analysis of construction-related criteria air pollutants is not required.

The proposed project would involve some demolition activity and include material transport operations involving more than 10,000 cubic yards of soil; therefore, the air district screening criteria would not be met directly. However, based on the City's experience from conducting quantitative criteria air pollutant analyses for larger projects that required more excavation and still resulted in emissions that were below the air district's significance thresholds, it can be assumed that the proposed project would not exceed the thresholds. This conclusion is further substantiated by the fact that the proposed project would have only 66 percent of the air district's construction criteria pollutant screening criterion value for the amount of office space (approximately 182,352 square feet compared to 277,000 square feet). Therefore, quantification of project-generated criteria air pollutant emissions would not be required. The proposed project would not exceed any of the significance thresholds for criteria air pollutants and would result in ***less-than-significant*** impacts.

The proposed project would not exceed the thresholds established for construction-related fugitive dust or criteria air pollutants. Therefore, construction of the proposed project would not result in a cumulatively considerable contribution to criteria pollutants for which the SFBAAB has been designated as a non-attainment area with respect to the NAAQS or CAAQS. This impact would be ***less than significant***.

Operational Emissions of Criteria Air Pollutants and Precursors

The SAPP EIR determined that emissions of criteria air pollutants and precursors associated with the operation of land uses under the SAPP would not result in an exceedance of any NAAQS or CAAQS, based on the two significance criteria recommended by BAAQMD for evaluating plan-level impacts. First, as described in the response to question "a," above, the SAPP would be consistent with the applicable emissions control measures of BAAQMD's 2010 Clean Air Plan. Second, the

⁵ Bay Area Air Quality Management District. 2017. *California Environmental Quality Act Air Quality Guidelines*. May. Available: https://www.baaqmd.gov/~media/files/planning-and-research/ceqa/ceqa_guidelines_may2017-pdf.pdf?la=en. Accessed: September 4, 2021.

increase in the number of vehicle trips associated with implementation of the SAPP would not exceed the increase in the service population (i.e., residential population plus the employee population) supported by this development.

As noted above, the air district provides screening-level sizes for land use projects in Table 3-1 of its CEQA Guidelines. As stated in the guidelines, “if a project meets the screening criteria in Table 3-1, a project would not result in the generation of operational-related criteria air pollutants and/or precursors that exceed the thresholds of significance.”⁶ If a project meets the criteria, then a detailed analysis of operational criteria air pollutants is not required.

The screening-level size for operational criteria air pollutants pertaining to a general office building is 346,000 square feet. Because the proposed project would approximately 182,352 square feet, it would meet the screening criteria, and a detailed analysis would not be required. Therefore, quantification of project-generated criteria air pollutant emissions would not be required.

Consequently, the proposed project would not exceed any of the significance thresholds for criteria air pollutants, resulting in a *less-than-significant* impact.

Summary

Because construction and operation of the proposed project would not result in a cumulatively considerable contribution to criteria pollutants for which the SFBAAB is designated as a non-attainment area with respect to the NAAQS or CAQCS, this impact would be *less than significant*. Therefore, the findings of the SAPP EIR remain valid regarding construction-related or operational emissions of criteria air pollutants and precursors, and no further analysis is required on this topic in a supplemental or subsequent EIR. The proposed project would not result in new significant impacts or a substantial increase in the severity of impacts related to cumulatively considerable contribution to criteria pollutants that were analyzed in the SAPP EIR.

c. *Would the project expose sensitive receptors to substantial pollutant concentrations?*

Sensitive receptors include those land uses where exposure to pollutants could result in health-related risks for sensitive individuals, including children and the elderly. Residential dwellings, schools, hospitals, day-care facilities, and similar facilities are of primary concern because of the presence of individuals who are particularly sensitive to pollutants and/or the potential for increased and prolonged exposure to pollutants.

Separate discussions are provided below regarding the proposed project’s potential to expose sensitive receptors to substantial concentrations of TACs during project construction, TACs during long-term operation of stationary sources, or CO resulting from project-induced traffic congestion.

Construction-Generated Emissions of Toxic Air Contaminants

The SAPP EIR discussed TACs emitted during construction activity. The construction of new development under the SAPP would result in temporary, intermittent emissions of diesel particulate matter (DPM) from the exhaust of the heavy-duty off-road diesel equipment used for grading and excavation, utility installations, paving, building construction, the application of architectural coatings, and building demolition. CARB identified DPM as a TAC in 1998. Furthermore, DPM is the primary TAC of concern associated with construction activity. Because of the lack of specific

⁶ Ibid.

construction information available at the time when the SAPP EIR was prepared, the program-level analysis in the SAPP EIR determined that the construction of new projects under the SAPP could result in the exposure of sensitive receptors to substantial concentrations of DPM and associated health risks, which would represent a significant impact. Mitigation Measure AIR-1 in the SAPP EIR requires all new development projects to conduct a construction health risk assessment and modify equipment usage as necessary to ensure that construction activity does not result in a carcinogenic health risk of more than 10 in 1 million, an increased non-cancer risk of more than 1.0 on the hazard index (chronic or acute), or an annual average ambient PM_{2.5} increase greater than 0.3 microgram per cubic meter (µg/m³). Therefore, the SAPP EIR determined that the impact would be **less than significant with mitigation**.

Construction of the proposed project would involve the same types of DPM-emitting activities that were analyzed in the SAPP EIR. Therefore, implementation of Mitigation Measure AIR-1 from the SAPP EIR would be required to reduce this impact to a level less than the health risk exposure criteria recommended by BAAQMD (i.e., an incremental increase in cancer risk greater than 10 in 1 million). The proposed project's TAC impacts are evaluated in the discussion that follows.

The primary TAC of concern associated with the proposed project is DPM, which is a carcinogen emitted by diesel internal-combustion engines. Construction activities would generate DPM (PM_{2.5} exhaust)⁷ that could expose adjacent receptors to significant health risks. As noted in Chapter 2, *Project Description*, all off-road diesel equipment used during construction would be equipped with EPA-approved Tier 4 Final engines, which would result in reduced DPM emissions relative to the average engine tier for construction equipment in California. Table 3.1-2 presents the maximum construction-related health risks for the maximum exposed receptor within 1,000 feet of construction activities.

Table 3.1-2. Project-Level Cancer and Chronic Hazard Risks and PM_{2.5} Concentrations During Project Construction

Receptor	Cancer Risk (cases per million)	Non-Cancer Hazard Index	Annual PM _{2.5} Concentration (µg/m ³)
Maximum Exposed Receptor	4.26	< 0.01	0.03
<i>Significance Threshold</i>	<i>10</i>	<i>1</i>	<i>0.3</i>
<i>Exceed Threshold?</i>	<i>No</i>	<i>No</i>	<i>No</i>

Source: See Appendix A for modeling outputs and calculations.

Notes:

µg/m³ = micrograms per cubic meter; PM_{2.5} = particulate matter no more than 2.5 microns in diameter

As shown in Table 3.1-2, neither the cancer risk, non-cancer hazard index, or annual PM_{2.5} concentration at the maximum exposed receptor would exceed BAAQMD's threshold of 10 per 1 million, 1, or 0.3 µg/m³, respectively. Therefore, this impact would be **less than significant**.

Cumulative Emissions of Toxic Air Contaminants

According to BAAQMD's guidelines, combined risk and concentration levels should be determined at all nearby DPM and PM_{2.5} sources within 1,000 feet of a project site. In addition, the combined risk and concentration levels should be compared to BAAQMD's cumulative thresholds.

⁷ Per BAAQMD guidance, PM_{2.5} exhaust is used as a surrogate for DPM.

The proposed project would involve construction activities that would generate DPM and PM_{2.5}. Existing DPM and PM_{2.5} sources within 1,000 feet of the project site could, along with the proposed project, contribute to a cumulative health risk for existing and future sensitive receptors adjacent to or within the project site. BAAQMD data files and distance multipliers provided by BAAQMD were used to estimate background impacts and concentrations for existing stationary, roadway, and rail sources. The combined risks from the proposed project and ambient sources are summarized in Table 3.1-3. The methods used to estimate project emissions are described in Appendix A.

Table 3.1-3. Maximum Cumulative Health Risks from the Proposed Project

Source	Cancer Risk (case per million)	Non-Cancer Hazard Index	Annual PM _{2.5} Concentration (µg/m ³)
Contribution from Existing Sources^a			
Stationary Sources	3.0	0.01	—
Roadway Sources	42.1	—	0.9
Rail Sources	10.7	—	< 0.1
Contribution from Project Construction			
Maximum Exposed Receptor	4.26	< 0.01	< 0.1
Cumulative Totals			
Existing + Project Construction	60.1	0.02	0.9
<i>Significance Thresholds</i>	<i>100</i>	<i>10</i>	<i>0.8</i>
<i>Exceed Threshold?</i>	<i>No</i>	<i>No</i>	<i>Yes</i>

Source: See Appendix A for modeling outputs and calculations.

^a Contribution from existing sources represents health risks within 1,000 feet of the maximum exposed receptor.

Notes:
µg/m³ = micrograms per cubic meter; PM_{2.5} = particulate matter no more than 2.5 microns in diameter

As shown in Table 3.1-3, the cumulative cancer risk and hazard index would not exceed BAAQMD's cumulative thresholds. However, the cumulative annual PM_{2.5} concentration would exceed BAAQMD's threshold. This represents a potentially significant cumulative impact. However, the proposed project's contribution to that cumulative impact would not be considerable because the project-only contribution would be relatively minor and much smaller than that of the ambient sources. As shown in the table above, the vast majority of the PM_{2.5} concentration (i.e., approximately 97 percent) is from existing ambient roadway sources; less than 3 percent would be from the proposed project. In light of this, the proposed project's contribution would not be considered considerable. Although the total cumulative PM_{2.5} concentration would exceed BAAQMD's threshold, the threshold would be exceeded even in the absence of the proposed project. Therefore, the proposed project's contribution would not substantially change the PM_{2.5} concentration at the maximum exposed receptor. This impact would be ***less than significant***.

Stationary-Source Emissions of Toxic Air Contaminants

The SAPP EIR explained that any new stationary sources of TACs (e.g., boilers, backup diesel generators) developed under the SAPP would be subject to BAAQMD permitting requirements, thereby ensuring that they would not emit levels of TACs that would expose sensitive receptors, such as schools and residences, to excessive health risks. This would also be true for the proposed project.

Mobile-Source Emissions of Carbon Monoxide

The SAPP EIR did not evaluate the potential for traffic associated with operation of new land uses under the SAPP to result in, or contribute to, localized concentrations of CO that would exceed the applicable NAAQS or CAAQS. However, because heavy traffic congestion can contribute to high levels of CO, and individuals exposed to such hot spots may have a greater likelihood of developing adverse health effects, traffic analysis is provided herein for the proposed project.

BAAQMD has adopted the following screening criteria, which provide a conservative indication of whether project-generated traffic would cause a potential CO hot spot:

1. The project would be consistent with an applicable congestion management program (CMP) established by the county congestion management agency for designated roads or highways, a regional transportation plan, and local congestion management agency plans;
2. Project traffic would not increase traffic volumes at affected intersections beyond 44,000 vehicles per hour; and
3. Project traffic would not increase traffic volumes at affected intersections beyond 24,000 vehicles per hour where vertical and/or horizontal mixing is substantially limited (e.g., a tunnel, parking garage, bridge underpass, natural or urban street canyon, below-grade roadway).

As shown in Table 16 of the Multimodal Transportation Analysis (MTA) for the proposed project, there would be no conflicts at intersections that are considered CMP intersections.⁸ The proposed project would not result in a change in level of service or substantially increase average critical delay at any of the CMP intersections.

Figure 12 of the MTA presents the AM and PM peak-hour intersection vehicle volumes for existing plus-project conditions. In that figure, it is apparent that the combined vehicle volumes at each intersection would be well below 24,000 vehicles per hour. As such, the proposed project would not exceed the BAAQMD screening criteria for peak-hour intersection vehicle volumes.

Because the proposed project would not violate the screening criteria, traffic generated by the proposed project would not result in, or contribute to, localized CO concentrations that would exceed the applicable NAAQS or CAAQS.

Summary

Any new stationary sources of TACs (e.g., boilers, backup diesel generators) that would operate as part of the proposed project would be subject to BAAQMD permitting requirements, thereby ensuring that they would not expose sensitive receptors to health risks that would exceed BAAQMD-established exposure criteria. Also, traffic generated by the proposed project would not result in, or contribute to, localized CO concentrations that would exceed the applicable NAAQS or CAAQS. Because implementation of Mitigation Measure AIR-1 from the Final SAPP would ensure that DPM emitted during project construction would not expose sensitive receptors to health risks that would exceed BAAQMD-established criteria, this impact would be ***less than significant with mitigation***. Because there would be no new significant impacts or substantially more severe impacts related to the exposure of sensitive receptors to substantial pollutant concentrations, the findings of the SAPP EIR remain valid, and no further analysis is required in a

⁸ Fehr and Peers 2021. *Multimodal Transportation Analysis – San Antonio Center Phase III*. September.

supplemental or subsequent EIR. The proposed project would not result in new significant impacts or a substantial increase in the severity of impacts related to the exposure of sensitive receptors to substantial pollutant concentrations that were analyzed in the SAPP EIR.

d. Would the project result in other emissions (such as those leading to odors) that would adversely affect a substantial number of people?

The SAPP EIR recognized that the diesel-powered equipment and vehicles used during the demolition of existing land uses and the construction of new land uses would emit odorous diesel exhaust. However, such emissions would be short term and limited to the construction areas. The SAPP EIR determined that new land uses developed under the SAPP, including retail establishments, residential units, and office/commercial space, would not involve long-term operation of sources that would emit odorous emissions, which would be atypical in an urban environment. Therefore, the SAPP EIR determined that implementation of the SAPP would not result in objectionable odors that would adversely affect a substantial number of people. This impact would be ***less than significant***.

The types of odor-emitting sources associated with the project's short-term construction and demolition activities would be the same as those analyzed in the SAPP EIR. Odor-generating activities that would be part of project construction would not occur near off-site sensitive receptors for an extended period. Given the temporary and intermittent nature of construction activities, project construction is not anticipated to result in an adverse odor-related impact.

The office/commercial and retail land uses developed on the project site would not involve long-term operation of sources that would emit odorous emissions, which would be atypical in an urban environment, or the development of any major sources of odors (e.g., a landfill, wastewater treatment plant, dairy). Because there would be no new significant impacts or substantially more severe impacts related to odors, the findings of the SAPP EIR remain valid, and no further analysis is required in a supplemental or subsequent EIR. The proposed project would not result in new significant impacts or a substantial increase in the severity of impacts related to odors that were analyzed in the SAPP EIR.

Applicable SAPP EIR Mitigation Measures and City Standard Conditions of Approval

SAPP EIR Mitigation Measures

The full text of the SAPP EIR mitigation measures applicable to the proposed project are identified below.

Mitigation Measure AIR-1

All new development projects, associated with implementation of the SA Precise Plan, which include buildings within 1,000 feet of a residential dwelling unit shall conduct a construction health risk assessment to assess emissions from all construction equipment during each phase of construction prior to issuance of building permits. Equipment usage shall be modified as necessary to ensure that equipment use would not result in a carcinogenic health risk of more than 10 in 1 million, an increased non-cancer risk of greater than 1.0 on the hazard index (chronic or acute), or an annual average ambient PM_{2.5} increase greater than 0.3 µg/m³.

Conditions of Approval

The full text of the City's standard Conditions of Approval applicable to the proposed project are identified below.

COA PL-192 Basic Air Quality Construction Measures

The applicant shall require all construction contractors to implement the basic construction mitigation measures recommended by the Bay Area Air Quality Management District (BAAQMD) to reduce fugitive dust emissions. Emission reduction measures will include, at a minimum, the following measures. Additional measures may be identified by the BAAQMD or contractor as appropriate, such as: (a) all exposed surfaces (e.g., parking areas, staging areas, soil piles, graded areas, and unpaved access roads) will be watered two times per day; (b) all haul trucks transporting soil, sand, or other loose material off-site will be covered; (c) all visible mud or dirt track-out onto adjacent public roads will be removed using wet power vacuum street sweepers at least once per day. The use of dry power sweeping is prohibited; (d) all vehicle speeds on unpaved roads will be limited to 15 mph; (e) all roadways, driveways, and sidewalks to be paved will be completed as soon as possible. Building pads will be laid as soon as possible after grading unless seeding or soil binders are used; and (f) post a publicly visible sign with the telephone number and person to contact at the lead agency regarding dust complaints. This person will respond and take corrective action within 48 hours. The BAAQMD's phone number will also be visible to ensure compliance with applicable regulations.

	Did the Program EIR Identify a Significant Impact and Mitigation Measures?	Do Program EIR Mitigation Measures Apply to the Project?	Does New Information of Substantial Importance Require Preparation of a Supplemental Subsequent EIR?	Is There No New Information of Importance Requiring Preparation of a Supplemental/ Subsequent EIR?
II. Biological Resources				
Would the project:				
a. Have a substantial adverse effect, either directly or through habitat modifications, on any species identified as a candidate, sensitive, or special status species in local or regional plans, policies, or regulations, or by the California Department of Fish and Wildlife or U.S. Fish and Wildlife Service?	<input type="checkbox"/>	<input type="checkbox"/>	<input type="checkbox"/>	<input checked="" type="checkbox"/>
b. Have a substantial adverse effect on any riparian habitat or other sensitive natural community identified in local or regional plans, policies, regulations or by the California Department of Fish and Wildlife or U.S. Fish and Wildlife Service?	<input type="checkbox"/>	<input type="checkbox"/>	<input type="checkbox"/>	<input checked="" type="checkbox"/>
c. Have a substantial adverse effect on state or federally protected wetlands (including, but not limited to, marsh, vernal pool, coastal, etc.) through direct removal, filling, hydrological interruption, or other means?	<input type="checkbox"/>	<input type="checkbox"/>	<input type="checkbox"/>	<input checked="" type="checkbox"/>
d. Interfere substantially with the movement of any native resident or migratory fish or wildlife species or with established native resident or migratory wildlife corridors, or impede the use of native wildlife nursery sites?	<input type="checkbox"/>	<input type="checkbox"/>	<input type="checkbox"/>	<input checked="" type="checkbox"/>
e. Conflict with any local policies or ordinances protecting biological resources, such as a tree preservation policy or ordinance?	<input type="checkbox"/>	<input type="checkbox"/>	<input type="checkbox"/>	<input checked="" type="checkbox"/>
f. Conflict with the provisions of an adopted Habitat Conservation Plan, Natural Community Conservation Plan, or other approved local, regional, or state habitat conservation plan?	<input type="checkbox"/>	<input type="checkbox"/>	<input type="checkbox"/>	<input checked="" type="checkbox"/>

Note: A checked box indicates a “yes” answer.

3.2 Biological Resources

a. *Would the project have a substantial adverse effect, either directly or through habitat modifications, on any species identified as a candidate, sensitive, or special status species in local or regional plans, policies, or regulations, or by the California Department of Fish and Wildlife or U.S. Fish and Wildlife Service?*

The SAPP EIR found that impacts related to substantial adverse effects on candidate, sensitive, or special status species would be less than significant.

Because the project site and surrounding area are composed entirely of commercial, office, and residential developments and no sensitive natural community is present on the project site or within the Plan Area, the project site does not provide suitable foraging or breeding habitat for any special-status species. The wildlife species that would occur at the project site would be generalists

that have adapted to human-modified habitats. Therefore, the proposed project's impacts associated with special-status species would be **less than significant**. The proposed project would not result in new significant impacts or a substantial increase in the severity of impacts regarding special-status species that were analyzed in the SAPP EIR.

b. *Would the project have a substantial adverse effect on any riparian habitat or other sensitive natural community identified in local or regional plans, policies, regulations or by the California Department of Fish and Wildlife or U.S. Fish and Wildlife Service?*

The SAPP EIR found that impacts related to substantial adverse effects on aquatic, wetland, or riparian habitat or other sensitive natural community would be less than significant.

The project site and surrounding Plan Area are composed entirely of commercial, office, and residential developments. No riparian habitat or other sensitive natural community are present on the project site or in the immediate vicinity. In addition, the project would be required to implement the City's standard stormwater Conditions of Approval (COA), such as FEP-05, *Construction Sediment and Erosion Control Plan*, and FEP-22, *Stormwater Treatment (C.3)*, which would help to protect water quality and improve stormwater runoff. Therefore, the proposed project would have **no impact** associated with riparian habitat or other sensitive natural communities. The proposed project would not result in new significant impacts or a substantial increase in the severity of impacts regarding riparian habitat or other sensitive natural communities that were analyzed in the SAPP EIR.

c. *Would the project have a substantial adverse effect on state or federally protected wetlands (including, but not limited to, marsh, vernal pool, coastal, etc.) through direct removal, filling, hydrological interruption, or other means?*

The SAPP EIR found that impacts related to substantial adverse effects on state or federally protected wetlands would be less than significant.

No federally protected wetlands or other jurisdictional waters are present on the project site or in the immediate vicinity of the Plan Area. Any design features incorporated into the project site that would use water (e.g., bio-filtration planters) would be solely for landscaping purposes. No direct removal, filling, or hydrological interruption to state or federally protected wetlands would occur as a result of the project. As mentioned above, the project would be required to implement the City's standard stormwater COAs, which would help protect water quality and any wetlands or bodies of water outside of the project site and Plan Area. Therefore, the proposed project would have **no impact** associated with state or federally protected wetlands. The proposed project would not result in new significant impacts or a substantial increase in the severity of impacts regarding state or federally protected wetlands that were analyzed in the SAPP EIR.

d. *Would the project interfere substantially with the movement of any native resident or migratory fish or wildlife species or with established native resident or migratory wildlife corridors, or impede the use of native wildlife nursery sites?*

The SAPP EIR found that impacts related to substantial adverse effects on candidate, sensitive, or special-status species would be less than significant.

As detailed above, no wetlands or running waters are present in the vicinity of the project site; therefore, the project would not affect fish movement. All project activities would occur within an already developed footprint surrounded by development. Therefore, the project would not result in

fragmentation within natural habitats that would interfere with the movement of wildlife. Any common urban-adapted species that currently move through the project site would continue to be able to do so following construction.

There are 22 existing trees on the project site. Of these trees, 13 would be removed, including five Heritage Trees, and nine trees would remain. Up to 19 additional trees would be planted throughout the project site, for a total of 28 trees onsite upon project completion. In addition, shrubs and ground cover would be planted throughout the project site. If the project is implemented during the nesting season (February 1–August 31), tree and structure removal could result in *take* (i.e., direct mortality of adult or young birds, the destruction of active nests, or disturbance of nesting adults, with associated nest abandonment or loss of reproductive effort). However, the project would be required to adhere to the City's standard COAs, which include PL-198, *Preconstruction Nesting Bird Survey*. This COA requires that the project applicant conduct a survey of the project site using a qualified biologist, and if an active nest is identified, no-disturbance buffer zones will be established and maintained until the biologist determines the nest is no longer active or the nesting season ends. With adherence to the City's standard COAs, specifically those related to nesting birds, the project would not interfere with the movement of any species. Therefore, the proposed project's impacts associated with the movement of any native resident or migratory fish or wildlife species would be ***less than significant***. The proposed project would not result in new significant impacts or a substantial increase in the severity of impacts regarding the movement of any native resident or migratory fish or wildlife species that were analyzed in the SAPP EIR.

e. Would the project conflict with any local policies or ordinances protecting biological resources, such as a tree preservation policy or ordinance?

The SAPP EIR found that impacts related to conflicts with local plans or ordinances protecting biological resources would be less than significant.

There are currently 22 trees on the project site, including five Heritage Trees. According to the *San Antonio Precise Plan* (Precise Plan), certain trees are subject to conditions before removal. Construction activities associated with the project would remove 13 trees, including the five Heritage Trees, and preserve nine of the existing trees. In addition to the nine trees that would remain onsite, the project would plant an additional 19 trees at the project site. As described in Chapter 2, *Project Description*, the project includes a request for a Heritage Tree Removal Permit, which is subject to City review and approval with conditions. In addition, the project would be required to adhere to the City's standard COAs related to trees, including the following:

- *COA PL-134, Arborist Inspections, and COA PL-135, Monthly Arborist Inspections*
- *COA PL-139, Replacement*
- *COA PL-141, Street Tree Protections*
- *COA PL-142, Tree Protection Measures*
- *COA PL-143, Security Bond*

Adherence to the above-listed standard COAs would ensure that the project would comply with the City's regulations regarding the removal of trees. To comply with COA PL-139, the loss of five Heritage Trees at the project site would be offset with the planting of 19 trees at the project site. Each replacement tree would have a box no smaller than 24 inches, and the landscape plan would

include a note that states “Heritage Replacement Tree.” To comply with Standard COA PL-142, tree protection measures would be included as notes on the title sheet of all grading and landscape plans. A Tree Removal Permit is part of the project application and would need to be approved pursuant to the policies and objectives set forth in the City’s ordinance regulating trees. With adherence to the above-referenced COAs and conformance with the necessary Tree Removal Permit, the project would not conflict with any local policies or ordinances that protect biological resources, such as a tree preservation policy or ordinance. Therefore, the proposed project’s impacts associated with conflicts with local policies or ordinances protecting biological resources would be **less than significant**. The proposed project would not result in new significant impacts or a substantial increase in the severity of impacts regarding conflicts with local policies or ordinances that were analyzed in the SAPP EIR.

f. Conflict with the provisions of an adopted Habitat Conservation Plan, Natural Community Conservation Plan, or other approved local, regional, or state habitat conservation plan?

The SAPP EIR found that there would be no impacts related to conflicts with the provisions of an adopted Habitat Conservation Plan (HCP), Natural Community Conservation Plan (NCCP), or other approved local, regional, or state habitat conservation plans.

No adopted or proposed HCPs or NCCPs are applicable to the project site or Plan Area. The nearest area covered by an HCP, the Santa Clara Valley HCP, is approximately 9.5 miles south of the project site (Santa Clara Valley Habitat Agency 2021). Therefore, the proposed project would have **no impact** associated with conflicts with an adopted HCP, NCCP, or other approved local, regional, or state HCP. The proposed project would not result in new significant impacts or a substantial increase in the severity of impacts regarding conflicts with adopted HCPs or NCCPs that were analyzed in the SAPP EIR.

Applicable SAPP EIR Mitigation Measures and City Standard Conditions of Approval

SAR EIR Mitigation Measures

No mitigation measures were identified as required for the proposed project.

Conditions of Approval

The full text of the City’s standard Conditions of Approval applicable to the proposed project are identified below.

COA FEP-05 Construction Sediment and Erosion Control Plan

The applicant shall submit a written plan acceptable to the City which shows controls that will be used at the site to minimize sediment runoff and erosion during storm events. The plan should include installation of the following items where appropriate: (a) silt fences around the site perimeter; (b) gravel bags surrounding catch basins; (c) filter fabric over catch basins; (d) covering of exposed stockpiles; (e) concrete washout areas; (f) stabilized rock/gravel driveways at points of egress from the site; and (g) vegetation, hydroseeding, or other soil stabilization methods for high-erosion areas. The plan should also include routine street sweeping and storm drain catch basin cleaning.

COA FEP-22 Stormwater Treatment (C.3)

This project will create or replace more than ten thousand (10,000) square feet of impervious surface; therefore, stormwater runoff shall be directed to approved permanent treatment controls as described in the City's guidance document entitled, "Stormwater Quality Guidelines for Development Projects." The City's guidelines also describe the requirement to select Low-Impact Development (LID) types of stormwater treatment controls; the types of projects that are exempt from this requirement; and the Infeasibility and Special Projects exemptions from the LID requirement.

The "Stormwater Quality Guidelines for Development Projects" document requires applicants to submit a Stormwater Management Plan, including information such as the type, location, and sizing calculations of the treatment controls that will be installed. Include three stamped and signed copies of the Final Stormwater Management Plan with the building plan submittal. The Stormwater Management Plan must include a stamped and signed certification by a qualified Engineer, stating that the Stormwater Management Plan complies with the City's guidelines and the State NPDES Permit. Stormwater treatment controls required under this condition may be required to enter into a formal recorded Maintenance Agreement with the City.

COA PL-134 Arborist Inspections

During demolition activity and upon demolition completion, a qualified arborist shall inspect and verify the measures described in the arborist report are appropriately implemented for construction activity near and around the preserved trees, including the critical root zones. Should it be determined that the root systems are more extensive than previously identified and/or concerns are raised of nearby excavation or construction activities for the project foundation or underground parking garage, the design of the building and/or parking garage may need to be altered to maintain the health of the trees prior to building permit issuance.

COA PL-135 Monthly Arborist Inspections

Throughout demolition and construction, a qualified arborist must conduct monthly inspections to ensure tree protection measures and maintenance care are provided. A copy of the inspection letter, including recommendations for modifications to tree care or construction activity to maintain tree health, shall be provided to the Planning Division at planning.division@mountainview.gov.

COA PL-139 Replacement Trees

The applicant shall offset the loss of each Heritage/street tree with _____ replacement trees, for a total of _____ replacement trees. Each replacement tree shall be no smaller than a 24" box and shall be noted on the landscape plan as Heritage or street replacement trees.

COA PL-141 Street Tree Protections

All designated City street trees are to be protected throughout construction activity with protection measures shown on building permit plans.

COA PL-142 Tree Protection Measures

The tree protection measures listed in the arborist's report prepared by _____ and dated _____ shall be included as notes on the title sheet of all grading and landscape plans. These measures shall include, but may not be limited to, 6' chain link fencing at the drip line, a continuous maintenance and care program, and protective grading techniques. Also, no materials may be stored within the drip line of any tree on the project site.

COA PL-143 Security Bond

The applicant shall post a security bond to ensure that replacement trees are planted and become established (one year after planting) and to compensate for the trees that were lost due to illegal removal.

COA PL-198 Preconstruction Nesting Bird Survey

To the extent practicable, vegetation removal and construction activities shall be performed from September 1 through January 31 to avoid the general nesting period for birds. If construction or vegetation removal cannot be performed during this period, preconstruction surveys will be performed no more than two days prior to construction activities to locate any active nests as follows:

The applicant shall be responsible for the retention of a qualified biologist to conduct a survey of the project site and surrounding 500' for active nests—with particular emphasis on nests of migratory birds—if construction (including site preparation) will begin during the bird nesting season, from February 1 through August 31. If active nests are observed on either the project site or the surrounding area, the applicant, in coordination with the appropriate City staff, shall establish no-disturbance buffer zones around the nests, with the size to be determined in consultation with the California Department of Fish and Wildlife (usually 100' for perching birds and 300' for raptors). The no-disturbance buffer will remain in place until the biologist determines the nest is no longer active or the nesting season ends. If construction ceases for two days or more and then resumes during the nesting season, an additional survey will be necessary to avoid impacts on active bird nests that may be present.

	Did the Program EIR Identify a Significant Impact and Mitigation Measures?	Do Program EIR Mitigation Measures Apply to the Project?	Does New Information of Substantial Importance Require Preparation of a Supplemental Subsequent EIR?	Is There No New Information of Importance Requiring Preparation of a Supplemental/ Subsequent EIR?
III. Cultural Resources and Tribal Cultural Resources				
Would the project:				
a. Cause a substantial adverse change in the significance of a historical resource pursuant to § 15064.5?	<input type="checkbox"/>	<input type="checkbox"/>	<input type="checkbox"/>	<input checked="" type="checkbox"/>
b. Cause a substantial adverse change in the significance of an archaeological resource pursuant to § 15064.5?	<input type="checkbox"/>	<input type="checkbox"/>	<input type="checkbox"/>	<input checked="" type="checkbox"/>
c. Disturb any human remains, including those interred outside of dedicated cemeteries?	<input type="checkbox"/>	<input type="checkbox"/>	<input type="checkbox"/>	<input checked="" type="checkbox"/>

Note: A checked box indicates a “yes” answer.

3.3 Cultural Resources

Northwest Information Center Records Search

On April 20, 2021, ICF requested an updated records search for the proposed project from the Northwest Information Center (NWIC) in Rohnert Park, California, a part of the California Historic Resource Information System. NWIC returned results on May 5, 2021. They did not identify any resources within the project site, but four cultural resources were found within 0.5 mile of the project site, as listed in Table 3.3-1. No tribal cultural resources were found during Phases 1 and 2 of construction at the Village at San Antonio Center.

Table 3.3-1. Previously Recorded Archaeological Resources within 0.5 mile of the Project Site

P-Number	Trinomial	Description
43-000021	CA-SCL-1	Castro Mound. This site was a prehistoric occupation site, originally 6–7 feet tall. Nelson (1910) described it as 500 feet (152.4 meters) long and 325 feet (99 meters) wide, but today only southernmost portions remain. Three to four hundred burials were found in this mound. Cultural material found includes shell, faunal bones, hearths, ground stone tools, and lithic flakes. A 2010 revisit failed to find the site (Chang 2015).
43-000042	CA-SCL-022	CA-SCL-022, also called the Little Castro, was described by L. L. Loud in 1912 as a small to moderately sized habitation site. The site’s dimensions at the time were 150 feet (45.7 meters) in diameter, at least 3 feet (0.9 meters) deep and 2.5 to 3 feet (0.8 to 0.9 meters) high. The site has been heavily disturbed, and no evidence of a mound currently exists, but Martinez and Moore observed shell and debitage in the soil during their 2010 field survey (Martinez and Moore 2010).

P-Number	Trinomial	Description
43-000595	CA-SCL-600	Originally described as a surface shell-laden midden scatter and a subsurface archaeological deposit containing burned rock, ground stone artifacts, flaked stone artifacts, and various types of shell measuring 984 feet by 492 feet (300 by 150 meters) by 3.3 feet (1 meter) thick. A 2010 field survey found that the site is no longer visible due to development, although evidence of subsurface midden deposits was found (Much 2015).
43-003172		Prehistoric midden measuring 3.3 feet (1 meter) north-south by 1.6 feet (0.49 meter) east-west and containing shell and groundstone. This heavily disturbed site was recorded in 2010, incorrectly identified as P-43-000021 (Chang 2015).

a. *Would the project cause a substantial adverse change in the significance of a historical resource pursuant to § 15064.5?*

The SAPP EIR provided a programmatic-level analysis of the SAPP and explained that select built-environment resources (i.e., buildings, structures, objects, and districts) located within the plan area had been evaluated previously for historical significance and were determined not to qualify as significant historical resources under CEQA. Generally, pursuant to the CEQA Guidelines Section 15064.5(a), a historical resource requiring special consideration under CEQA would be one of the following: a resource meeting the eligibility requirements of the California Register of Historical Resources (CRHR); a resource included in a local register of historical resources; a significant resource identified in a qualifying local survey; or a resource otherwise treated as significant by the CEQA lead agency.

However, the SAPP area was not subject to a comprehensive historical resource survey and inventory at the time the SAPP EIR was prepared, and it contains additional built-environment resources that had reached historic age (generally, 50 years old), but had not been evaluated for listing in the local historical register, CRHR, or National Register of Historic Places (NRHP). As such, it remained unknown whether any built-environment resources in the SAPP area qualified as significant historical resources requiring consideration during CEQA review. The SAPP EIR noted, however, that the *City of Mountain View 2030 General Plan* (General Plan) and General Plan EIR contained the following actions applicable to built-environment resources:

- **ACTION Land Use Designation (LUD) 11.1.1:** *Register of Historic Resources.* Maintain and update the Mountain View Register of Historic Resources.
- **ACTION LUD 11.1.3:** *Historic resource changes.* Utilize the development review process to ensure that changes to historic resources are consistent with the U.S. Secretary of Interior Standards for the Treatment of Historic Properties.
- **ACTION LUD 11.3.1:** *Early historic evaluation.* Identify and evaluate historic and cultural resources early in the development review process.

The SAPP EIR also invoked three of the City of Mountain View's (City) conditions of approval:

- COA PL-161, *Secretary of the Interior Standards*
- COA PL-162, *Documentation of Historic Resource*
- COA PL-163, *Salvage Program*

The SAPP EIR stated that the impacts of projects resulting from the SAPP would be analyzed during future project-level review. Action LUD 11.3.1, *Early historic evaluation*, specifically identifies the need to evaluate the CEQA historical resource status of historic-aged built-environment resources that may be altered or demolished by future proposed projects. The SAPP EIR concluded that the need for future project-level review, as supported by the application of the three General Plan actions and three COAs, ensured that the SAPP would not cause substantial adverse change in the significance of any historical resource pursuant to PRC Section 15064.5, and its impact to historical resources would be less than significant.

The project site, which lies within the boundaries of the SAPP area, contains two buildings; both are now more than 50 years old, meaning they have the potential to qualify as CEQA historical resources: 365 San Antonio Road (assessor's parcel number [APN] 148-22-005), constructed in 1952, and 2585 California Street (APN 148-22-007), constructed in 1961.¹ Neither building has been previously evaluated for CRHR or NRHP listing or otherwise considered for CEQA historical resource status. Furthermore, no buildings immediately adjacent to the project site appear to be of historic age.² Pursuant to General Plan Action LUD 11.3.1, the buildings at 365 San Antonio Road and 2585 California Street were evaluated for CRHR and NRHP listing. ICF completed an intensive-level historical resources survey of both buildings. The buildings' physical characteristics, historic context, site history, and NRHP/CRHR evaluations were documented on Department of Parks and Recreation (DPR) 523A (Primary Record) and 523B (Building, Structure, Object) forms, which are included in Appendix B.

Based on these evaluations, neither historic-aged building located within the project site is eligible for NRHP or CRHR listing because of the lack of significance under NRHP/CRHR evaluative criteria. As a result, neither building meets the requirements of a historical resource presented in the CEQA Guidelines Section 15064.5(a); construction of the project would thus not impair the significance of a significant built-environment historical resource materially. Therefore, similar to those impacts identified in the SAPP EIR, the proposed project's impacts associated with built-environment historical resources would be *less than significant*. The proposed project would not result in new significant impacts or a substantial increase in the severity of impacts regarding built-environment historical resources that were analyzed in the SAPP EIR.

b. *Would the project cause a substantial adverse change in the significance of an archaeological resource pursuant to § 15064.5?*

The SAPP EIR found that impacts related to substantial adverse changes in the significance of an archaeological resource pursuant to PRC Section 15064.5 would be less than significant.

As discussed previously, there is a potential for significant historic-period archaeological deposits to occur, given the history of development along the El Camino Real corridor portion of the SAPP area. Construction of the proposed project would include activities such as demolition, excavation, and foundation and building construction, which have the potential to destroy prehistoric and historical archaeological deposits, including previously unidentified subsurface deposits.

¹ The street addresses used in this section, as well as the appended Department of Parks and Recreation (DPR) forms, refer to the addresses historically assigned to the two buildings within the project site. The parcel containing 2585 California Street currently bears the address 2585–2595 California Street, which is utilized in other sections of this Addendum.

² The records search results also included several built-environment resources. However, none of those resources is located within or adjacent to the project site. Because the previously identified built-environment resources have low impact potential due to their physical distance from the project site, they are not discussed in this impact analysis.

The General Plan and General Plan EIR identified the following policies and actions to address potential impacts to archaeological deposits:

- **ACTION LUD 11.3.1:** *Early historic evaluation.* Identify and evaluate historic and cultural resources early in the development review process.
- **POLICY LUD 11.5:** *Archaeological and paleontological site protection.* Require all new development to meet state codes regarding the identification and protection of archaeological and paleontological deposits.
- **ACTION LUD 11.5.1:** *Review Historic Property Directory List.* Prior to approval of development permits for projects that include ground-disturbing activities, City staff will review the most recent and updated NWIC list, Historic Property Directory for the County of Santa Clara, to determine if known archaeological and paleontological sites underlie the proposed project. If it is determined that known cultural resources are within one-quarter mile of the project site, the City will require the project applicant to conduct an NWIC records search at Sonoma State University to confirm whether there are any recorded cultural resources within or adjacent to the project site. Based on that research, the City will determine whether field study by a qualified cultural resources consultant is recommended.
- **ACTION LUD 11.5.2:** *Pre-construction cultural resource surveys.* Should City staff determine that field study for cultural resources is required, the project applicant will have a cultural resource professional meeting the Secretary of the Interior's Standards in history or archaeology conduct a preconstruction survey to identify significant cultural resources—including archaeological sites, paleontological resources, and human remains—in the project site and provide project-specific recommendations, as needed. Coordination with local Native American communities should be performed when significant cultural resources and remains are identified as part of pre-approval site analysis.

City staff has determined no field survey for the proposed project is necessary per Action LUD 11.5.2. In addition, the project would comply with Standard COA PL-194, which pertains to the discovery of archaeological resources during ground-disturbing activities.

The SAPP EIR found that impacts related to tribal cultural resources would be less than significant. The General Plan and General Plan EIR policies and actions listed above that pertain to archeological resources and below that pertain to human remains also apply to tribal cultural resources. Additionally, the project would comply with Standard COA PL-195, which pertains to the discovery of human remains during ground-disturbing activities, which would also protect tribal cultural resources.

Therefore, the proposed project's impacts associated with archaeological and tribal cultural resources would be ***less than significant***. The proposed project would not result in new significant impacts or a substantial increase in the severity of impacts regarding archaeological resources and tribal cultural resources that were analyzed in the SAPP EIR.

c. Would the project disturb any human remains, including those interred outside of dedicated cemeteries?

The SAPP EIR found that impacts related to disturbance of any human remains, including those interred outside of dedicated cemeteries, would be less than significant by adhering to the following mitigation measures. Typically, such human remains are associated with prehistoric archaeological habitation sites, (e.g., shell middens). As discussed previously, the city includes several recorded

prehistoric archaeological deposits, including those that contain Native American human remains. Construction of the proposed project would include activities such as demolition, excavation, and foundation and building construction, which have the potential to destroy prehistoric archaeological deposits that may include associated human remains.

The General Plan and General Plan EIR identified the following policies and actions to address potential impacts to human remains:

- **POLICY LUD 11.6:** *Protect Human Remains.* Utilize the development review process to identify and protect human remains and follow the appropriate procedures outlined under Health and Safety Code Section 7050.5 and PRC Section 5097.98.
- **ACTION LUD 11.6.1:** *Human Remains.* Should human remains be found on a project site, no further excavation or disturbance of the site or any nearby area reasonably suspected to overlie adjacent human remains will be disturbed until the Santa Clara County Coroner is contacted and determines that no investigation of the cause of death is required. If an investigation is required, and the coroner determines the remains to be Native American, then: (1) the coroner would contact the Native American Heritage Commission within 24 hours; (2) the Native American Heritage Commission would identify the person or persons it believes to be the most likely descended from the deceased Native American; and (3) the most likely descendent may make recommendations to the landowner or the person responsible for the excavation work, for means of treating or disposing of, with appropriate dignity, the human remains and any associated grave goods as provided in PRC Section 5097.98.

In addition, the project would comply with Standard COA PL-195, which pertains to the discovery of human remains during ground-disturbing activities. Therefore, the proposed project's impacts associated with human remains would be ***less than significant***. The proposed project would not result in new significant impacts or a substantial increase in the severity of impacts regarding human remains that were analyzed in the SAPP EIR.

Applicable SAPP EIR Mitigation Measures and City Standard Conditions of Approval

SAPP EIR Mitigation Measures

No mitigation measures were identified as required for the proposed project.

Conditions of Approval

The full text of the City's standard Conditions of Approval applicable to the proposed project are identified below.

COA PL-194 Discovery of Archaeology Resources

If prehistoric or historic-period cultural materials are unearthed during ground-disturbing activities, it is recommended that all work within 100' of the find be halted until a qualified archaeologist and Native American representative can assess the significance of the find. Prehistoric materials might include obsidian and chert-flaked stone tools (e.g., projectile points, knives, scrapers) or tool-making debris; culturally darkened soil ("midden") containing heat-affected rocks and artifacts; stone milling equipment (e.g., mortars, pestles, handstones, or milling slabs); and battered-stone tools, such as hammerstones and pitted stones. Historic-period materials might include stone, concrete, or adobe

footings and walls; filled wells or privies; and deposits of metal, glass, and/or ceramic refuse. If the find is determined to be potentially significant, the archaeologist, in consultation with the Native American representative, will develop a treatment plan that could include site avoidance, capping, or data recovery.

COA PL-195 Discovery of Human Remains

In the event of the discovery of human remains during construction or demolition, there shall be no further excavation or disturbance of the site within a 50' radius of the location of such discovery, or any nearby area reasonably suspected to overlie adjacent remains. The Santa Clara County Coroner shall be notified and shall make a determination as to whether the remains are Native American. If the Coroner determines that the remains are not subject to his/her authority, he/she shall notify the Native American Heritage Commission, which shall attempt to identify descendants of the deceased Native American. If no satisfactory agreement can be reached as to the disposition of the remains pursuant to this State law, then the landowner shall reinter the human remains and items associated with Native American burials on the property in a location not subject to further subsurface disturbance. A final report shall be submitted to the City's Community Development Director prior to release of a Certificate of Occupancy. This report shall contain a description of the mitigation programs and its results, including a description of the monitoring and testing resources analysis methodology and conclusions, and a description of the disposition/curation of the resources. The report shall verify completion of the mitigation program to the satisfaction of the City's Community Development Director.

	Did the Program EIR Identify a Significant Impact and Mitigation Measures?	Do Program EIR Mitigation Measures Apply to the Project?	Does New Information of Substantial Importance Require Preparation of a Supplemental Subsequent EIR?	Is There No New Information of Importance Requiring Preparation of a Supplemental/ Subsequent EIR?
V. Geology and Soils				
Would the project:				
a. Directly or indirectly cause potential substantial adverse effects, including the risk of loss, injury, or death involving:				
i. Rupture of a known earthquake fault, as delineated on the most recent Alquist-Priolo Earthquake Fault Zoning Map, issued by the State Geologist for the area or based on other substantial evidence of a known fault? Refer to Division of Mines and Geology Special Publication 42.	<input type="checkbox"/>	<input type="checkbox"/>	<input type="checkbox"/>	<input checked="" type="checkbox"/>
ii. Strong seismic ground shaking?	<input type="checkbox"/>	<input type="checkbox"/>	<input type="checkbox"/>	<input checked="" type="checkbox"/>
iii. Seismic-related ground failure, including liquefaction?	<input type="checkbox"/>	<input type="checkbox"/>	<input type="checkbox"/>	<input checked="" type="checkbox"/>
iv. Landslides?	<input type="checkbox"/>	<input type="checkbox"/>	<input type="checkbox"/>	<input checked="" type="checkbox"/>
b. Result in substantial soil erosion or the loss of topsoil?	<input type="checkbox"/>	<input type="checkbox"/>	<input type="checkbox"/>	<input checked="" type="checkbox"/>
c. Be located on a geologic unit or soil that is unstable, or that would become unstable as a result of the project, and potentially result in on- or off-site landslide, lateral spreading, subsidence, liquefaction or collapse?	<input type="checkbox"/>	<input type="checkbox"/>	<input type="checkbox"/>	<input checked="" type="checkbox"/>
d. Be located on expansive soil, as defined in Table 18-1-B of the Uniform Building Code (1994), creating substantial direct or indirect risks to life or property?	<input type="checkbox"/>	<input type="checkbox"/>	<input type="checkbox"/>	<input checked="" type="checkbox"/>
e. Have soils incapable of adequately supporting the use of septic tanks or alternative wastewater disposal systems where sewers are not available for the disposal of waste water?	<input type="checkbox"/>	<input type="checkbox"/>	<input type="checkbox"/>	<input checked="" type="checkbox"/>
f. Directly or indirectly destroy a unique paleontological resource or site or unique geologic feature?	<input type="checkbox"/>	<input type="checkbox"/>	<input type="checkbox"/>	<input checked="" type="checkbox"/>

Note: A checked box indicates a “yes” answer.

3.4 Geology and Soils

The SAPP EIR found that impacts related to geology and soils or paleontological resources would be less than significant.

a. *Would the project directly or indirectly cause potential substantial adverse effects, including the risk of loss, injury, or death involving:*

i. *Rupture of a known earthquake fault, as delineated on the most recent Alquist-Priolo Earthquake Fault Zoning Map, issued by the State Geologist for the area or based on other substantial evidence of a known fault? Refer to Division of Mines and Geology Special Publication 42.*

The SAPP EIR concluded that impacts related to surface fault rupture of an earthquake fault would be less than significant. No major faults with displacement within the past 11,000 years (i.e., active faults) underlie the SAPP area. Development in the City of Mountain View (City) is subject to existing regulations that establish building standards and permit requirements. New development associated with the SAPP is required to comply with these regulations and requirements. The SAPP EIR also identified several policies and actions in the General Plan, as well as applicable standard conditions of approval (COAs) that would apply to new development resulting from implementation of the SAPP, listed below.

- General Plan policies and actions
 - Policy INC 2.3: Emergency-prepared infrastructure design. Require the use of available technologies and earthquake-resistant materials in the design and construction of all infrastructure projects, whether constructed by the City or others.
 - Policy PSA 4.2: Natural disasters. Minimize impacts of natural disasters.
 - Action PSA 4.2.1: Enforce building codes. Enforce building and fire codes and standards.
 - Action PS 4.2.2: Develop a mitigation plan. Develop a Local Hazard Mitigation Plan.
 - Policy PSA 5.1 New development. Ensure new development addresses seismically induced geologic hazards.
 - Action PSA 5.1.1 Financial incentives. Explore and apply financial and other incentives to help private entities replace or upgrade seismically unsafe structures.
 - Action PSA 5.1.2 Upgrade public buildings. Replace or upgrade seismically unsafe City-owned buildings and structures.
 - Action PSA 5.1.3. Hazard studies. Review development projects in potentially seismic areas to ensure that geotechnical investigations are prepared following State guidelines and relevant local codes.
 - Policy PSA 5.2 Alquist-Priolo zones. Require development to comply with the Alquist-Priolo Fault Zoning Act.
- Applicable COAs
 - PL-48 Geotechnical Report. The applicant shall have a design-level geotechnical investigation prepared which includes recommendations to address and mitigate geologic hazards in accordance with the specifications of CGS Special Publication 117, Guidelines for Evaluating and Mitigating Seismic Hazards, and the requirements of the Seismic Hazards Mapping Act.

Compliance with these regulations, standards, requirements, COAs, and policies would reduce impacts relative to surface fault rupture to less than significant.

The proposed project would demolish two single-story commercial buildings and associated surface parking and construct a commercial building with open spaces and a below-grade parking garage. The proposed project would comply with existing regulations, standards, requirements, as well as COAs and policies listed above. In addition, the proposed project would not exacerbate risk of surface fault rupture. Therefore, similar to those impacts identified in the SAPP EIR, the proposed project's impacts associated with surface fault rupture would be ***less than significant***. The proposed project would not result in new significant impacts or a substantial increase in the severity of impacts regarding surface fault rupture that were analyzed in the SAPP EIR.

ii. Strong seismic ground shaking?

The SAPP EIR concluded that impacts related to strong seismic ground-shaking as a result of earthquake would be less than significant. Although major regional faults located near city are capable of producing very strong to violent ground-shaking within the SAPP area, existing federal, state, and local regulations, programs, and standards provide current information detailing seismic hazards and impose regulatory requirements regarding geotechnical and soils investigations. New development associated with the SAPP is required to comply with these regulations and requirements. The SAPP EIR also identified several policies and actions in the General Plan, as well as applicable COAs, that would apply to new development resulting from implementation of the SAPP, listed below.

- General Plan policies and actions
 - Policy INC 2.3: Emergency-prepared infrastructure design.
 - Policy PSA 4.2: Natural disasters.
 - Action PSA 4.2.1: Enforce building codes.
 - Action PS 4.2.2: Develop a mitigation plan.
 - Policy PSA 5.1 New development.
 - Action PSA 5.1.1 Financial incentives.
 - Action PSA 5.1.2 Upgrade public buildings.
 - Action PSA 5.1.3. Hazard studies.
 - Policy PSA 5.2 Alquist-Priolo zones.
- Applicable COAs
 - PL-48 Geotechnical Report.

Compliance with these regulations, standards, requirements, COAs, and policies would reduce impacts relative to strong seismic ground shaking to less than significant.

The proposed project would demolish two single-story commercial buildings and associated surface parking and construct a commercial building with open spaces and a below-grade parking garage. The proposed project would comply with existing regulations, standards, requirements, as well as COAs and policies listed above. In addition, the proposed project would not exacerbate risk of strong seismic ground-shaking. Therefore, similar to those impacts identified in the SAPP EIR, the proposed project's impacts associated with strong seismic ground shaking would be ***less than significant***. The proposed project would not result in new significant impacts or a substantial increase in the severity of impacts regarding strong seismic ground shaking that were analyzed in the SAPP EIR.

iii. Seismic-related ground failure, including liquefaction?

The SAPP EIR concluded that impacts related to seismic-related ground failure, including liquefaction, would be less than significant. Although the SAPP area is underlain by materials with a moderate liquefaction potential, federal, state, and local regulations, programs, and standards provide current information detailing seismic hazards and impose regulatory requirements regarding geotechnical and soils investigations. New development associated with the SAPP is required to comply with these regulations and requirements. The SAPP EIR also identified several policies and actions in the General Plan, as well as applicable COAs, that would apply to new development resulting from implementation of the SAPP, listed below.

- General Plan policies and actions
 - Policy INC 2.3: Emergency-prepared infrastructure design.
 - Policy PSA 4.2: Natural disasters.
 - Action PSA 4.2.1: Enforce building codes.
 - Action PS 4.2.2: Develop a mitigation plan.
 - Policy PSA 5.1 New development.
 - Action PSA 5.1.1 Financial incentives.
 - Action PSA 5.1.2 Upgrade public buildings.
 - Action PSA 5.1.3. Hazard studies.
 - Policy PSA 5.2 Alquist-Priolo zones.
- Applicable COAs
 - PL-48 Geotechnical Report.

Compliance with these regulations, standards, requirements, COAs, and policies would reduce impacts relative to liquefaction and lateral spreading to less than significant.

The proposed project would demolish two single-story commercial buildings and associated surface parking and construct a commercial building with open spaces and a below-grade parking garage. The proposed project would comply with existing regulations, standards, requirements, as well as COAs and policies listed above. Therefore, similar to those impacts identified in the SAPP EIR, the proposed project's impacts associated with liquefaction and lateral spreading would be ***less than significant***. The proposed project would not result in new significant impacts or a substantial increase in the severity of impacts regarding liquefaction and lateral spreading that were analyzed in the SAPP EIR.

iv. Landslides?

The SAPP EIR concluded that impacts related to seismically induced landslide would be less than significant. Topography in the SAPP area is generally level. Development in the city is subject to existing regulations that establish building standards and permit requirements. New development associated with the SAPP is required to comply with these regulations and requirements. The SAPP EIR also identified several policies and actions in the General Plan, as well as applicable COAs, that would apply to new development resulting from implementation of the SAPP, listed below.

- General Plan policies and actions
 - Policy INC 2.3: Emergency-prepared infrastructure design.
 - Policy PSA 4.2: Natural disasters.
 - Action PSA 4.2.1: Enforce building codes.
 - Action PS 4.2.2: Develop a mitigation plan.
 - Policy PSA 5.1 New development.
 - Action PSA 5.1.1 Financial incentives.
 - Action PSA 5.1.2 Upgrade public buildings.
 - Action PSA 5.1.3. Hazard studies.
 - Policy PSA 5.2 Alquist-Priolo zones.
- Applicable COAs
 - PL-48 Geotechnical Report.

Compliance with these regulations, standards, requirements, COAs, and policies would reduce impacts relative to seismic-related landslide to less than significant.

The proposed project would demolish two single-story commercial buildings and associated surface parking and construct a commercial building with open spaces and a below-grade parking garage. The proposed project would comply with existing regulations, standards, requirements, as well as COAs and policies listed above. In addition, the proposed project would not exacerbate risk of seismic-related landslide. Therefore, similar to those impacts identified in the SAPP EIR, the proposed project's impacts associated with seismically induced landslide would be *less than significant*. The proposed project would not result in new significant impacts or a substantial increase in the severity of impacts regarding seismically induced landslide that were analyzed in the SAPP EIR.

b. Would the project result in substantial soil erosion or the loss of topsoil?

The SAPP EIR concluded that impacts related to substantial soil erosion or loss of topsoil would be less than significant. Construction associated with development or redevelopment under the SAPP could include activities that would cause erosion, decrease in water quality, and loss of topsoil. Development in the city is subject to existing regulations, including Section 35.32.10 of the City of Mountain View Municipal Code, that require all development projects to be conducted in a manner that prevents stormwater pollution. In addition, all development resulting from implementation of the SAPP would be required to comply with identified stormwater policies and COAs, listed below.

- General Plan policies and actions
 - Policy INC 8.2: National Pollutant Discharge Elimination System Permit. Comply with requirements in the Municipal Regional Stormwater National Pollutant Discharge Elimination System Permit (MRP).
 - Policy INC 8.4: Runoff pollution prevention. Reduce the amount of stormwater runoff and stormwater pollution entering creeks, water channels and the San Francisco Bay through participation in the Santa Clara Valley Urban Runoff Pollution Prevention Program.

- Policy INC 8.5: Site-specific stormwater treatment. Require post-construction stormwater treatment controls consistent with MRP requirements for both new development and redevelopment projects.
- Applicable COAs
 - FEP-03. State of California Construction General Stormwater Permit: A "Notice of Intent" (NOI) and "Stormwater Pollution Prevention Plan" (SWPPP) shall be prepared for construction projects disturbing one (1) acre or more of land. Proof of coverage under the State General Construction Activity Stormwater Permit shall be attached to the building plans.
 - FEP-04. Construction Best Management Practices: All construction projects shall be conducted in a manner which prevents the release of hazardous materials, hazardous waste, polluted water, and sediments to the storm drain system. Refer to the City of Mountain View document, "It's In the Contract But Not In the Bay," for the specific construction practices required at the job site.
 - FEP-05. Construction Sediment and Erosion Control Plan: The applicant shall submit a written plan acceptable to the City which shows controls that will be used at the site to minimize sediment runoff and erosion during storm events. The plan should include installation of the following items where appropriate: (a) silt fences around the site perimeter; (b) gravel bags surrounding catch basins; (c) filter fabric over catch basins; (d) covering of exposed stockpiles; (e) concrete washout areas; (f) stabilized rock/ gravel driveways at points of egress from the site; and (g) vegetation, hydroseeding, or other soil stabilization methods for high-erosion areas. The plan should also include routine street sweeping and storm drain catch basin cleaning.

Compliance with these regulations, standards, requirements, COAs, and policies would reduce the potential for substantial erosion and loss of topsoil to less than significant.

The proposed project would involve ground-disturbing activities, including grading and excavation. These activities potentially could result in substantial erosion. However, the proposed project would be subject to the same regulations and COAs identified in the SAPP EIR. Therefore, similar to those impacts identified in the SAPP EIR, the proposed project's impacts associated with substantial soil erosion or loss of topsoil would be *less than significant*. The proposed project would not result in new significant impacts or a substantial increase in the severity of impacts regarding substantial soil erosion or loss of topsoil that were analyzed in the SAPP EIR.

c. Would the project be located on a geologic unit or soil that is unstable, or that would become unstable as a result of the project, and potentially result in on- or off-site landslide, lateral spreading, subsidence, liquefaction or collapse?

The SAPP EIR concluded that impacts related to project location on a geologic unit or soil that is unstable or would become unstable as a result of the project would be less than significant. Because of the low relief of local topography, potential impacts related to landslide also would be less than significant. New development associated with the SAPP would involve use of water managed by Santa Clara Valley Water District, which receives a portion of its water supplies from groundwater. In addition, new development associated with the SAPP would have a risk of collapse of trench walls and construction on materials with moderate liquefaction potential. However, the SAPP EIR also identified COAs, including a requirement to complete a geotechnical investigation and a soils report to identify and mitigate geologic and soils hazards in project site design, and General Plan policies and actions relevant to subsidence, collapse, liquefaction, and lateral spreading.

- General Plan policies and actions
 - Policy INC 2.3: Emergency-prepared infrastructure design.
 - Policy PSA 4.2: Natural disasters.
 - Action PSA 4.2.1: Enforce building codes.
 - Action PS 4.2.2: Develop a mitigation plan.
 - Policy PSA 5.1 New development.
 - Action PSA 5.1.1 Financial incentives.
 - Action PSA 5.1.2 Upgrade public buildings.
 - Action PSA 5.1.3. Hazard studies.
 - Policy PSA 5.2 Alquist-Priolo zones.
 - Policy INC 4.11: Water Supply. Maintain a reliable water supply.
 - Action INC 4.1.1: Urban Water Management Plan and Water Master Plan. Comply with provisions of the City’s Urban Water Management Plan and Water Master Plan and regularly update them to reflect long-term land use planning decisions.
 - Action INC 4.1.2: Groundwater quality and regulations. Closely monitor groundwater quality as well as any changing rules and regulations regarding the City’s access to groundwater, revising plans as necessary to reflect any relevant changes to the groundwater supply.
 - Policy INC 4.2: Participating in regional organizations. Participate in regional water supply organizations, support their efforts to maintain and improve the water supply, and monitor statewide and regional water supplies.
- Applicable COAs
 - PL-48 Geotechnical Report.

Adherence to these COAs and General Plan policies would reduce impacts related to subsidence, collapse, liquefaction, and lateral spreading to less than significant.

The proposed project would involve increased water demand, excavation that could create steep earthen walls, and construction on materials subject to liquefaction and lateral spreading. The proposed project would comply with the same existing regulations, standards, requirements, as well as COAs and policies listed above as the SAPP. Therefore, similar to those impacts identified in the SAPP EIR, the proposed project’s impacts associated with unstable geologic units or soils would be **less than significant**. The proposed project would not result in new significant impacts or a substantial increase in the severity of impacts regarding unstable geologic units or soils that were analyzed in the SAPP EIR.

d. *Would the project be located on expansive soil, as defined in Table 18-1-B of the Uniform Building Code (1994), creating substantial direct or indirect risks to life or property?*

The SAPP EIR concluded that impacts related to location of a project on expansive soil would be less than significant. Soils in the SAPP area have been identified as having a moderate to high shrink/swell potential. Implementation the following COAs would reduce this potential impact to less than significant.

- Applicable COAs
 - PL-48 Geotechnical Report.

The proposed project would also locate construction on expansive soil. The proposed project would comply with the same COAs listed above identified in the SAPP EIR. Therefore, similar to those impacts identified in the SAPP EIR, the proposed project's impacts associated with expansive soil would be **less than significant**. The proposed project would not result in new significant impacts or a substantial increase in the severity of impacts regarding expansive soil that were analyzed in the SAPP EIR.

e. Would the project have soils incapable of adequately supporting the use of septic tanks or alternative wastewater disposal systems where sewers are not available for the disposal of wastewater?

The SAPP EIR concluded that there would be **no impact** related to soils incapable of adequately supporting the use of septic tanks or alternative wastewater systems. The approved project is serviced by a sanitary sewer system operated by the City.

The proposed project would demolish two single-story commercial buildings and associated surface parking and construct a commercial building with open spaces and a below-grade parking garage. As with the approved project, these facilities would be serviced by the City's sanitary sewer system. Therefore, similar to those impacts identified in the SAPP EIR, the proposed project's impacts associated with use of septic tanks or alternative wastewater disposal systems would be **no impact**. The proposed project would not result in new significant impacts or a substantial increase in the severity of impacts regarding use of septic tanks or alternative wastewater disposal systems that were analyzed in the SAPP EIR.

f. Would the project directly or indirectly destroy a unique paleontological resource or site or unique geologic feature?

The SAPP EIR concluded that impacts related to a paleontological resource or site would be less than significant with adherence to COAs and General Plan policies and actions. Although no paleontological resources have been recovered in the city, geologic units underlie the SAPP area that are known to contain fossils, indicating paleontological sensitivity. The SAPP EIR identified several policies and actions in the General Plan that would apply to new development resulting from implementation of the SAPP, listed below.

- General Plan policies and actions
 - Action LUD 11.3.1: Early historic evaluation.
 - Policy LUD 11.5: Archaeological and paleontological site protection. Require all new development to meet state codes regarding the identification and protection of archaeological and paleontological deposits.
 - Action LUD 11.5.1: Review Historic Property Directory List.
 - Action LUD 11.5.2: Pre-construction cultural resource surveys.
 - Action LUD 11.5.3: Archaeological and paleontological standard conditions.

Compliance with these General Plan policies and actions would reduce impacts on paleontological resources and unique geologic features.

To accommodate construction of building foundations and a below-ground parking garage, the project would excavate to a maximum depth of approximately 55 feet (16.8 meters) below the ground surface, resulting in the export of approximately 55,350 cubic yards of soil. As identified in

the SAPP EIR, the geologic unit underlying the project site is sensitive for paleontological resources. The geologic unit underlying the project site is Quaternary Alluvium (Wagner et al. 1991), which is sensitive for paleontological resources, having yielded fossils of *Mammuthus* (mammoth), *Bison* (bison), *Equus* (horse), and others (Maguire and Holroyd 2016). The proposed project would comply with the same COAs and policies and actions identified in the General Plan and listed above as the approved project. Therefore, similar to those impacts identified in the SAPP EIR, the proposed project's impacts associated with paleontological resources would be **less than significant**. The proposed project would not result in new significant impacts or a substantial increase in the severity of impacts regarding paleontological resources that were analyzed in the SAPP EIR.

Applicable SAPP EIR Mitigation Measures and City Standard Conditions of Approval

SAPP EIR Mitigation Measures

No mitigation measures were identified as required for the proposed project.

Conditions of Approval

The full text of the City's standard Conditions of Approval applicable to the proposed project are identified below.

COA FEP-03 State of California Construction General Stormwater Permit

A "Notice of Intent" (NOI) and "Stormwater Pollution Prevention Plan" (SWPPP) shall be prepared for construction projects disturbing one (1) acre or more of land. Proof of coverage under the State General Construction Activity Stormwater Permit shall be attached to the building plans.

COA FEP-04 Construction Best Management Practices

All construction projects shall be conducted in a manner which prevents the release of hazardous materials, hazardous waste, polluted water, and sediments to the storm drain system. Refer to the City of Mountain View document, "It's In the Contract But Not In the Bay," for the specific construction practices required at the job site.

COA FEP-05 Construction Sediment and Erosion Control Plan

The applicant shall submit a written plan acceptable to the City which shows controls that will be used at the site to minimize sediment runoff and erosion during storm events. The plan should include installation of the following items where appropriate: (a) silt fences around the site perimeter; (b) gravel bags surrounding catch basins; (c) filter fabric over catch basins; (d) covering of exposed stockpiles; (e) concrete washout areas; (f) stabilized rock/gravel driveways at points of egress from the site; and (g) vegetation, hydroseeding, or other soil stabilization methods for high-erosion areas. The plan should also include routine street sweeping and storm drain catch basin cleaning.

COA PL-48 Geotechnical Report

The applicant shall have a design-level geotechnical investigation prepared which includes recommendations to address and mitigate geologic hazards in accordance with the specifications of CGS Special Publication 117, Guidelines for Evaluating and Mitigating Seismic Hazards, and the requirements of the Seismic Hazards Mapping Act.

	Did the Program EIR Identify a Significant Impact and Mitigation Measures?	Do Program EIR Mitigation Measures Apply to the Project	Does New Information of Substantial Importance Require Preparation of a Supplemental Subsequent EIR?	Is There No New Information of Importance Requiring Preparation of a Supplemental/ Subsequent EIR?
VI. Greenhouse Gas Emissions				
Would the project:				
a. Generate greenhouse gas emissions, either directly or indirectly, that may have a significant impact on the environment?	<input type="checkbox"/>	<input type="checkbox"/>	<input type="checkbox"/>	<input checked="" type="checkbox"/>
b. Conflict with an applicable plan, policy or regulation adopted for the purpose of reducing the emissions of greenhouse gases?	<input type="checkbox"/>	<input type="checkbox"/>	<input type="checkbox"/>	<input checked="" type="checkbox"/>

Note: A checked box indicates a “yes” answer.

3.5 Greenhouse Gas Emissions

a. Would the project generate greenhouse gas emissions, either directly or indirectly, that may have a significant impact on the environment?

The SAPP EIR found that impacts related to greenhouse gases (GHG) would be less than significant, because the SAPP would be consistent with the City’s Greenhouse Gas Reduction Plan (GGRP).

The project would result in the development of a new seven-story building and proposes a change in the limit of office development in the *Northwest San Antonio Master Plan*. The total office development limit would not change and would remain 600,000 gsf in the SAPP. Consequently, the project would not result in any substantial changes in GHG emissions from the buildout of the SAPP, because the distribution of office space within the SAPP sub-areas would not appreciably affect the level of GHG emissions. Construction of the seven-story building and the increase in the office development limit in the *Northwest San Antonio Master Plan* would generate a comparable amount of GHG emissions as the buildout as evaluated in the SAPP EIR because the type of construction activities and equipment would be similar. In addition, the types and magnitude of activities that generate operational GHG emissions for the project would also be similar to those analyzed in the SAPP EIR. In general, office development would result in emissions from building energy consumption, water consumption, waste generation, and on-road vehicle travel. Some emissions occur onsite (e.g., natural gas- and motor vehicle-related emissions), but those emissions enter into the atmosphere and disperse globally. Thus, if those emissions are emitted in the *Northwest San Antonio Master Plan* instead of elsewhere in the SAPP, it does not measurably change the contribution to climate change that was evaluated in the SAPP EIR. Furthermore, as noted in Section 3.13, *Transportation and Traffic*, the project site is within a 0.5-mile walk of rail and transit stops, which, according to California Public Resources Code Section 21155, indicates that the project is within 0.5 miles of a major transit stop. The City’s vehicle miles traveled (VMT) policy establishes screening criteria for developments, based on CEQA Guidelines Section 15064.3(b)(1), and concludes that certain projects within 0.5 mile of an existing major transit stop or an existing stop along a high-quality transit corridor will have a less-than-significant impact on VMT. The project would meet the City’s VMT reduction target, which was designed to meet statewide VMT and, thus, statewide GHG reduction goals, mobile source emissions from on-road vehicles. Reducing VMT is a key element of the state’s strategy for reducing GHG emissions.

Emissions from other sectors would be minimized through project features and compliance with statewide regulatory programs. For example, the project would be compliant with Leadership in Energy and Environmental Design (LEED) Gold and reduce water and energy consumption through low-flow fixtures and energy-efficient appliances. Waste at the project site would be diverted as much as possible through recycling and organics (i.e., compost) collection, which would reduce methane emissions from waste decomposing anaerobically in landfills. The project's electricity demand would come from progressively lower carbon sources, as the state's energy suppliers comply with the requirements of the Renewable Portfolio Standards. As such, in addition to being consistent with the City's GGRP, the project's emissions would be minimized by and compliant with applicable regulatory programs, such that emissions would be **less than significant**. The proposed project would not result in new significant impacts or a substantial increase in the severity of impacts regarding the generation of GHG emissions that may have a significant impact that were analyzed in the SAPP EIR.

b. *Would the project conflict with an applicable plan, policy or regulation adopted for the purpose of reducing the emissions of greenhouse gases?*

In 2012, the City adopted the *2030 Mountain View General Plan* (General Plan), which included the GGRP (City of Mountain View 2012) to mitigate the emissions associated with future development allowed under the General Plan. The GGRP identifies a series of GHG emissions reduction measures to be implemented by development projects that would allow the City to achieve its GHG reduction goals. The measures center around five strategy areas: energy, waste, water, transportation, and carbon sequestration.

The GGRP was considered to be a qualified GHG reduction plan pursuant to CEQA Guidelines Section 15183.5 because, among other attributes, it was adopted in a public process following environmental review provided in the City's *2030 General Plan and Greenhouse Gas Reduction Program EIR* (City of Mountain View 2014). As noted above, the construction of a seven-story building and a change to the office space limit in the *Northwest San Antonio Master Plan* would not appreciably change the level of emissions relative to those evaluated in the SAPP EIR because the type of land use (e.g., office space) and amount of land use (e.g., 600,000 gsf) would be unchanged. As such, implementation of the project would not cause a new conflict with any plan, policy, or regulation that was not identified in the SAPP EIR and this impact would be **less than significant**. The proposed project would not result in new conflicts with an applicable plan, policy or regulation adopted for the purpose of reducing the emissions of GHGs or a substantial increase in the severity of impacts regarding such plans, policies, or regulations that were analyzed in the SAPP EIR.

Applicable SAPP EIR Mitigation Measures and City Standard Conditions of Approval

SAPP EIR Mitigation Measures

No mitigation measures were identified as required for the proposed project.

Conditions of Approval

No City standard Conditions of Approval were identified as applicable to the proposed project.

	Did the Program EIR Identify a Significant Impact and Mitigation Measures?	Do Program EIR Mitigation Measures Apply to the Project?	Does New Information of Substantial Importance Require Preparation of a Supplemental Subsequent EIR?	Is There No New Information of Importance Requiring Preparation of a Supplemental/ Subsequent EIR?
VII. Hazards and Hazardous Materials				
Would the project:				
a. Create a significant hazard to the public or the environment through the routine transport, use, or disposal of hazardous materials?	<input type="checkbox"/>	<input type="checkbox"/>	<input type="checkbox"/>	<input checked="" type="checkbox"/>
b. Create a significant hazard to the public or the environment through reasonably foreseeable upset and accident conditions involving the release of hazardous materials into the environment?	<input type="checkbox"/>	<input type="checkbox"/>	<input type="checkbox"/>	<input checked="" type="checkbox"/>
c. Emit hazardous emissions or handle hazardous or acutely hazardous materials, substances, or waste within one-quarter mile of an existing or proposed school?	<input type="checkbox"/>	<input type="checkbox"/>	<input type="checkbox"/>	<input checked="" type="checkbox"/>
d. Be located on a site which is included on a list of hazardous materials sites compiled pursuant to Government Code § 65962.5 and, as a result, would it create a significant hazard to the public or the environment?	<input type="checkbox"/>	<input type="checkbox"/>	<input type="checkbox"/>	<input checked="" type="checkbox"/>
e. For a project located within an airport land use plan or, where such a plan has not been adopted, within two miles of a public airport or public use airport, would the project result in a safety hazard or excessive noise for people residing or working in the project area?	<input type="checkbox"/>	<input type="checkbox"/>	<input type="checkbox"/>	<input checked="" type="checkbox"/>
f. Impair implementation of or physically interfere with an adopted emergency response plan or emergency evacuation plan?	<input type="checkbox"/>	<input type="checkbox"/>	<input type="checkbox"/>	<input checked="" type="checkbox"/>
g. Expose people or structures, either directly or indirectly, to a significant risk of loss, injury or death involving wildland fires?	<input type="checkbox"/>	<input type="checkbox"/>	<input type="checkbox"/>	<input checked="" type="checkbox"/>

Note: A checked box indicates a “yes” answer.

3.6 Hazards and Hazardous Materials

The analysis in this section was supported by the *Phase I Environmental Site Assessment 365 San Antonio Road and 2585 and 2595 California Street Mountain View, California* (Phase I ESA) that Roux Associates, Inc., prepared for the proposed project dated July 27, 2020 (Roux Associates 2020).

a. *Would the project create a significant hazard to the public or the environment through the routine transport, use, or disposal of hazardous materials?*

The SAPP EIR stated that new development or redevelopment in the SAPP area would involve the routine management of hazardous materials that could pose a risk to human health or the environment if not properly managed or if accidentally released. Storage, use, handling, generation, transport, and disposal of said hazardous materials during site construction and operation activities would be subject to federal, state, and local laws and regulations, along with General Plan policies

and actions and applicable COAs. The SAPP EIR concluded that compliance with federal, state, and local requirements, General Plan policies and associated actions, and implementation of applicable COAs, would reduce the potential for impacts related to the use and handling of hazardous materials to a less-than-significant level.

The project proposes demolition of two single-story commercial buildings and associated surface parking and construction of a commercial building with open spaces and a below-grade parking garage. Thus, implementation of the proposed project would result in construction activities that would require the routine transport, use, or disposal of hazardous materials and hazardous wastes. If accidentally released, these materials could result in exposure risks for construction personnel and nearby residents. Similar to the analysis in the SAPP EIR, transport, use, and disposal of hazardous materials would comply with applicable federal and state regulations, such as the Resource Conservation and Recovery Act and Department of Transportation Hazardous Materials Regulations. In addition to compliance with the aforementioned regulations, the implementation of applicable General Plan policies (such as Policy PSA 3.2: *Protection from hazardous materials*, POLICY PSA 3.3: *Development review*) and COAs would also be required. Applicable COAs to the transport, use, or disposal of hazardous materials are as follows:

- COA BID-15 Hazardous Materials
- COA HAZ-02 Hazardous Materials
- COA HAZ-03 Installation or Upgrade of Hazardous Materials Storage

Because the proposed project involves office and retail uses, hazardous materials used during operations are expected to consist of common cleaners and other materials used for day-to-day maintenance. These materials are generally used in small quantities, and any spills generally are cleaned up as they occur. Therefore, impacts associated with the routine transport, use, or disposal of hazardous materials would be ***less than significant***. The proposed project would not result in new significant impacts or a substantial increase in the severity of impacts associated with the routine transport, use, or disposal of hazardous materials that were analyzed in the SAPP EIR.

b. Would the project create a significant hazard to the public or the environment through reasonably foreseeable upset and accident conditions involving the release of hazardous materials into the environment?

According to the SAPP EIR, hazardous material contamination from existing hazardous material release sites or hazardous building materials in buildings to be demolished could affect human health and the environment. The severity of health effects would depend on the contaminant(s), concentration, use of personal protective equipment, institutional controls, engineering controls, and duration of exposure. The disturbance and release of these materials during construction could pose an exposure risk to construction workers, nearby receptors, and the environment. The SAPP EIR concluded that compliance with General Plan policies and associated actions and implementation of applicable COAs would reduce the potential for impacts related to upset and accident conditions involving the release of hazardous materials to a less-than-significant level. Applicable COAs are as follows:

- COA PL-49 Toxic Assessment
- COA PL-193 Discovery of Contaminated Soils

A Phase I ESA was prepared for the proposed project by Roux Associates, Inc. in July of 2020. The purpose of the Phase I ESA was to identify Recognized Environmental Conditions (RECs)¹ in connection with the project site. Only one REC was identified in connection to the project site:

- **Former Shell Station 2595 California Street.** A former Shell station located within the project site at 2595 California Street was listed as a closed Leaking Underground Storage Tank (LUST) case with a gasoline release to groundwater. According to the Phase I ESA, all structures associated with the Shell site were removed, and the remaining hydrocarbon plume was limited to beneath the former station. Remediation, which involved soil excavation, vapor extraction, and groundwater extraction, was conducted and the case received closure in 2003. At the time, residual concentrations of contaminants were concluded to potentially pose an unacceptable risk for some site development activities. However, a Construction Management Plan (CMP) was prepared in 2020 and contained mechanisms to address the residual contaminants onsite. Specifically, the CMP identifies Risk Management Measures (those addressing potential impacts related to worker health and safety, stormwater pollution prevention, construction dewatering and vapor intrusion) along with guidance for soil management and management of unknown subsurface structures uncovered during construction. The CMP was dated April 6, 2020, and was included as an appendix to the July 2020 Phase I ESA prepared by Roux Associates, Inc. This REC associated with the former Shell station at 2595 California Street was considered resolved in the Phase I ESA.

In addition to the REC, four Business Environmental Risks (BERs) were identified with the project site. BERs are conditions that generally do not present a threat to human health or the environment and generally would not be the subject of an enforcement action; however, these conditions may have a material environmental or environmentally driven impact. As presented in the Phase I ESA, they include:

- **Nearby closed LUST cases:** At the time of the Phase I ESA's preparation, there were multiple closed LUST cases and a closed Cleanup Program case in the vicinity of the project site, related to gasoline in groundwater and waste oil/motor oil/hydraulic oil/lubricating oil in soil.
- **Adjacent gas station with multiple violations:** A Valero gas station located at 334 San Antonio Road has received multiple violations from the Mountain View Fire Department related to the lack of care in handling and storage of hazardous materials. However, there were no records of any significant releases to onsite soil or groundwater.
- **Agricultural pesticide use.** The project site was used for agricultural purposes between at least 1939 and at least 1950. According to the Phase I ESA, historic pesticide use on the project site may have caused impacts.
- **Potential asbestos use.** Based on the construction date of onsite structures, the Phase I ESA identified the possibility of asbestos containing building materials.

Because potential impacts associated with the proposed project involve residual contamination (in the form of a hydrocarbon release to groundwater and residual pesticides) and the potential existence of hazardous building materials (hazardous materials risks previously analyzed in the SAPP EIR),

¹ American Society for Testing Materials (ASTM) Standard Practice E1527-13 defines RECs as the presence or likely presence of any hazardous substances or petroleum products in, on, or at a property: (1) due to any release to the environment; (2) under conditions indicative of a release to the environment; or (3) under conditions that pose a material threat of a future release to the environment. *De minimis* conditions are not recognized environmental conditions.

compliance with General Plan policies and associated actions (such as Policy INC 18.1: *Contamination prevention*, Policy INC 18.2: *Contamination clean-up* and Policy PSA 3.4: *Oversight agencies*), along with implementation of applicable COAs, including *COA PL-193 Discovery of Contaminated Soils* and *COA PL-49 Toxic Assessment*, would reduce potential exposure risks of these materials during project construction. Furthermore, implementation of the Construction Management Plan for The Village at San Antonio Center – Block 3 prepared in 2020 would include mechanisms to address the potential for residual contamination associated with the former Shell station. Therefore, impacts associated with reasonably foreseeable upset and accident conditions involving the release of hazardous materials would be **less than significant**. The proposed project would not result in new significant impacts or a substantial increase in the severity of impacts associated with reasonably foreseeable upset and accident conditions involving the release of hazardous materials that were analyzed in the SAPP EIR.

c. *Would the project emit hazardous emissions or handle hazardous or acutely hazardous materials, substances, or waste within one-quarter mile of an existing or proposed school?*

The SAPP EIR identified that children are more susceptible to health effects from exposure to hazardous materials, substances, and waste than adults. As such, prospective school sites should be reviewed to determine that such sites are not contaminated by hazardous materials or located within a quarter-mile of land uses that manage substantial quantities of hazardous materials. California Education Code Sections 21151.2, 21151.4, and 21151.8 specifically require investigation of prospective school sites in accordance with Department of Toxic Substances Control guidance. Adherence to existing regulatory requirements and applicable General Plan policies and associated actions would reduce the potential for school children to be exposed to hazardous or acutely hazardous materials to a less-than-significant level.

There are no schools within one-quarter mile of the proposed project site, and, thus, impacts associated with hazardous emissions or the handling of hazardous or acutely hazardous materials near a school would not occur. There would be **no impact**. The proposed project would not result in new significant impacts or a substantial increase in the severity of impacts regarding hazardous emissions and materials near an existing or proposed school that were analyzed in the SAPP EIR.

d. *Would the project be located on a site which is included on a list of hazardous materials sites compiled pursuant to Government Code § 65962.5 and, as a result, would it create a significant hazard to the public or the environment?*

According to the SAPP EIR, the SAPP area contained several contaminated sites in varying states of remediation, including sites within the Cortese List. Direct contact, inhalation, or ingestion of hazardous materials associated with Cortese List sites could potentially cause adverse health effects to construction workers and future site users. The severity of health effects would depend on the contaminant(s), concentration, use of personal protective equipment, institutional controls, engineering controls, and duration of exposure. The disturbance and release of hazardous materials during construction activities, if present, could pose a hazard to construction workers, nearby receptors, and the environment. The SAPP EIR concluded that compliance with General Plan policies and associated actions and implementation of applicable COAs would reduce the potential for impacts related to Cortese List sites to a less-than-significant level. Applicable COAs are as follows:

- COA PL-49 Toxic Assessment
- COA PL-193 Discovery of Contaminated Soils

The former Shell station at 2595 California Street (discussed in detail under threshold b.) was listed in the LUST database and is also part of the Cortese List. Similar to what was described in threshold b., compliance with General Plan policies and associated actions (such as Policy INC 18.1: *Contamination prevention*, Policy INC 18.2: *Contamination clean-up* and Policy PSA 3.4: *Oversight agencies*) along with implementation of applicable COAs would reduce potential exposure risks associated with onsite contaminants during project construction. Furthermore, implementation of the Construction Management Plan would be used to address the potential residual contamination associated with the aforementioned Shell station. Therefore, impacts associated with the project site being located on a site which is included on a list of hazardous materials sites compiled pursuant to Government Code § 65962.5 would be **less than significant**. The proposed project would not result in new significant impacts or a substantial increase in the severity of impacts regarding hazardous materials sites compiled pursuant to Government Code § 65962.5 that were analyzed in the SAPP EIR.

e. *Would the project for a project located within an airport land use plan or, where such a plan has not been adopted, within two miles of a public airport or public use airport, would the project result in a safety hazard or excessive noise for people residing or working in the project area?*

The SAPP EIR determined that the SAPP area is not located within any protected airspace zones defined by the Airport Land Use Commission and has no heliports listed by the Federal Aviation Administration. No impact would occur.

Because the project site is within the SAPP area, potential airport impacts associated with the proposed project also would not occur. Therefore, the proposed project would have **no impact** related to airports. The proposed project would not result in new significant impacts or a substantial increase in the severity of impacts regarding airports that were analyzed in the SAPP EIR.

f. *Would the project impair implementation of or physically interfere with an adopted emergency response plan or emergency evacuation plan?*

General Plan policies require ongoing maintenance of existing emergency response plans, development of a new emergency response plan for damaged utilities, development of a Local Hazard Mitigation Plan, emergency response training, and collaboration with local communities, large employers, and Moffett Federal Airfield to coordinate emergency response and preparedness within the city. The SAPP EIR determined that increased traffic as a result of new development in the SAPP area could impair emergency response and evacuation procedures. However, the implementation of applicable General Plan policies and associated actions would reduce potential impacts related to impairment or interference with emergency response plans or emergency evacuation plans to a less-than-significant level.

All development associated with the proposed project would also be subject to applicable General Plan policies and associated actions, including policies that require the maintenance of efficient automobile infrastructure and effective Transportation Demand Management (TDM) programs such as: Policy MOB 10.1: *Efficient automobile infrastructure*, Policy MOB 10.2: *Reducing travel demand* and Policy MOB 10.4: *Emergency response* to reduce potential impacts to local emergency response and evacuation procedures. Therefore, potential impacts associated with the proposed project impairing or interfering with an adopted emergency response plan or emergency evacuation plan would be **less than significant**. The proposed project would not result in new significant impacts or a substantial increase in the severity of impacts regarding an adopted emergency response plan or emergency evacuation plan that were analyzed in the SAPP EIR.

g. Would the project expose people or structures, either directly or indirectly, to a significant risk of loss, injury or death involving wildland fires?

According to the analysis found in the SAPP EIR, there are no California Department of Forestry and Fire Protection's (CAL FIRE) Fire Hazard Severity Zones for state responsibility areas or Very High Fire Hazard Severity Zones for local responsibility areas within or adjacent to the SAPP area. As such, the SAPP EIR concluded that impacts related to wildland fire hazards on new development or redevelopment in the SAPP area would not occur. There would be no impact.

Because the project site is within the SAPP area, impacts related to wildland fires would also not occur. Therefore, the proposed project would have **no impact** related to wildland files. The proposed project would not result in new significant impacts or a substantial increase in the severity of impacts regarding wildland fires that were analyzed in the SAPP EIR.

Applicable SAPP EIR Mitigation Measures and City Standard Conditions of Approval

SAPP EIR Mitigation Measures

No mitigation measures were identified as required for the proposed project.

Conditions of Approval

The full text of the City's standard Conditions of Approval applicable to the proposed project are identified below.

COA BID-15 Hazardous Materials

Any installation of hazardous materials will require submittal of HMIS forms for the Fire Protection Engineer and the Hazardous Materials Specialist. Please visit City of Mountain View—Fire & Environmental Protection Division online at www.mountainview.gov/fep or by phone at 650-903-6378 to obtain information and submittal requirements.

COA HAZ-02 Hazardous Materials

If hazardous materials will be stored or used on-site (including paints, thinners, compressed gases, propane, diesel, gasoline, etc.), complete an Environmental Compliance Plan (ECP) application. Attach a copy of the completed ECP to your building plan submittal.

COA HAZ-03 Installation or Upgrade of Hazardous Materials Storage

"Installation or Upgrade of Hazardous Materials Storage or Use Areas" check sheet. All applicable items in the check sheet should be completed and shown on the building plan submittal.

COA PL-49 Toxic Assessment

A toxic assessment report shall be prepared and submitted as part of the building permit submittal. The applicant must demonstrate that hazardous materials do not exist on the site or that construction activities and the proposed use of this site are approved by: the City' Fire Department (Fire and Environmental Protection Division); the State Department of Health Services; the Regional Water Quality Control Board; and any Federal agency with jurisdiction. No building permits will be issued until each agency and/or department with jurisdiction has released the site as clean or a site toxics mitigation plan has been approved.

COA PL-193 Discovery of Contaminated Soils

If contaminated soils are discovered, the applicant will ensure the contractor employs engineering controls and Best Management Practices (BMPs) to minimize human exposure to potential contaminants. Engineering controls and construction BMPs will include, but not be limited to, the following: (a) contractor employees working on-site will be certified in OSHA's 40-hour Hazardous Waste Operations and Emergency Response (HAZWOPER) training; (b) contractor will stockpile soil during redevelopment activities to allow for proper characterization and evaluation of disposal options; (c) contractor will monitor area around construction site for fugitive vapor emissions with appropriate field screening instrumentation; (d) contractor will water/mist soil as it is being excavated and loaded onto transportation trucks; (e) contractor will place any stockpiled soil in areas shielded from prevailing winds; and (f) contractor will cover the bottom of excavated areas with sheeting when work is not being performed.

	Did the Program EIR Identify a Significant Impact and Mitigation Measures?	Do Program EIR Mitigation Measures Apply to the Project	Does New Information of Substantial Importance Require Preparation of a Supplemental Subsequent EIR?	Is There No New Information of Importance Requiring Preparation of a Supplemental/ Subsequent EIR?
VIII. Hydrology and Water Quality				
Would the project:				
a. Violate any water quality standards or waste discharge requirements or otherwise substantially degrade surface or ground water quality?	<input type="checkbox"/>	<input type="checkbox"/>	<input type="checkbox"/>	<input checked="" type="checkbox"/>
b. Substantially decrease groundwater supplies or interfere substantially with groundwater recharge such that the project may impede sustainable groundwater management of the basin?	<input type="checkbox"/>	<input type="checkbox"/>	<input type="checkbox"/>	<input checked="" type="checkbox"/>
c. Substantially alter the existing drainage pattern of the site or area, including through the alteration of the course of a stream or river or through the addition of impervious surfaces, in a manner which would:	<input type="checkbox"/>	<input type="checkbox"/>	<input type="checkbox"/>	<input checked="" type="checkbox"/>
i. result in a substantial erosion or siltation on- or offsite;	<input type="checkbox"/>	<input type="checkbox"/>	<input type="checkbox"/>	<input checked="" type="checkbox"/>
ii. substantially increase the rate or amount of surface runoff in a manner which would result in flooding on- or offsite;	<input type="checkbox"/>	<input type="checkbox"/>	<input type="checkbox"/>	<input checked="" type="checkbox"/>
iii. create or contribute runoff water which would exceed the capacity of existing or planned stormwater drainage systems or provide substantial additional sources of polluted runoff; or	<input type="checkbox"/>	<input type="checkbox"/>	<input type="checkbox"/>	<input checked="" type="checkbox"/>
iv. impede or redirect flood flows?	<input type="checkbox"/>	<input type="checkbox"/>	<input type="checkbox"/>	<input checked="" type="checkbox"/>
d. In flood hazard, tsunami, or seiche zones, risk release of pollutants due to project inundation?	<input type="checkbox"/>	<input type="checkbox"/>	<input type="checkbox"/>	<input checked="" type="checkbox"/>
e. Conflict with or obstruct implementation of a water quality control plan or sustainable groundwater management plan?	<input type="checkbox"/>	<input type="checkbox"/>	<input type="checkbox"/>	<input checked="" type="checkbox"/>

Note: A checked box indicates a “yes” answer.

3.7 Hydrology and Water Quality

a. *Would the project violate any water quality standards or waste discharge requirements or otherwise substantially degrade surface or ground water quality?*

The SAPP EIR concluded that impacts that would violate any water quality standards or waste discharge requirements or otherwise substantially degrade surface or ground water quality would be less than significant. Development associated with the approved project is subject to existing water quality regulations and programs that establish water quality standards and provide enforcement. New development associated with the approved project are required to comply with these regulations and programs. The SAPP EIR identified several policies and actions in the General Plan including INC 8.2 (National Pollutant Discharge Elimination System Permit), INC 8.4 (Runoff pollution prevention), INC 8.5 (Site-specific stormwater treatment), and INC 8.7 (Stormwater quality), as well as applicable COAs including COA FEP-05 (Construction Sediment and Erosion

Control Plan) and COA FEP-22 (Stormwater Treatment [C.3]), which require compliance with surface water and groundwater quality standards and waste discharge requirements. Therefore, the SAPP EIR concluded impacts to be less than significant.

The project proposes demolition of two single-story commercial buildings and associated surface parking and construction of a commercial building with open spaces and a below-grade parking garage. The proposed project would be required to comply with the water quality regulations and programs identified in the General Plan EIR, including the existing National Pollutant Discharge Elimination System (NPDES) permits for construction and post-construction, applicable General Plan policies, and COAs. The proposed project would also be required to comply with Municipal Regional Permit (MRP) Provision C.3, which requires that new development mitigate impacts on water quality by incorporating low impact development (LID) measures, including pollutant source control, stormwater treatment, and flow control measures. LID treatment measures include “capture and re-use” or rainwater harvesting, infiltration, bio-retention basins or flow-through planters, and green roofs. Project features, including planter boxes and a LID-based treatment system, would be used to treat stormwater runoff from the roof of the proposed building. Furthermore, proprietary biofiltration units and non-LID treatment systems would be used to treat ground-level stormwater runoff. Thus, implementation of the proposed project would not violate any water quality standards or waste discharge requirements. Therefore, **no impacts** associated with water quality standards or waste discharge requirements or otherwise substantially degrade surface or ground water quality would occur. The proposed project would not result in new significant impacts or a substantial increase in the severity of impacts regarding water quality standards or waste discharge requirements or impacts related to otherwise substantially degrading surface or ground water quality that were analyzed in the SAPP EIR.

b. *Would the project substantially decrease groundwater supplies or interfere substantially with groundwater recharge such that the project may impede sustainable groundwater management of the basin?*

The SAPP EIR concluded that impacts associated with groundwater supplies and recharge would be less than significant.

The City’s groundwater resources are located within the Santa Clara subbasin (Subbasin No. 2-9.02) (RWQCB 2017). The proposed project is within the service area of Santa Clara Valley Water District (SCVWD) and would not rely on groundwater supplies as a source for water. Development associated with the proposed project would result in an increase in impervious surface, covering recharge areas which would reduce groundwater aquifer recharge. However, the project site is in a developed area with minimal land facilitation of groundwater recharge. Therefore, impacts associated with groundwater supplies and recharge would be **less than significant**. The proposed project would not result in new significant impacts or a substantial increase in the severity of impacts regarding groundwater supplies and recharge that were analyzed in the SAPP EIR.

c. *Substantially alter the existing drainage pattern of the site or area, including through the alteration of the course of a stream or river or through the addition of impervious surfaces, in a manner which would:*

i. *Result in a substantial erosion or siltation on- or offsite?*

The SAPP EIR concluded that impacts associated with altering the existing drainage pattern and erosion or siltation on- or offsite would be less than significant.

Construction of the proposed project would comply with existing stormwater regulations and post-construction stormwater requirements under the NPDES Order No. 2009-0009 DWG and NPDES Order No. R2-2009-0074 and requirements outlined in the stormwater pollution prevention plan (SWPPP) prepared for the approved project. Furthermore, existing stormwater regulations regarding construction and post-construction stormwater requirements include extensive requirements for new development, reflected in applicable COAs (COA FEP-05 Construction Sediment and Erosion Control Plan), with which the proposed project would comply. Therefore, impacts associated with altering the existing drainage pattern that could result in erosion or siltation would be *less than significant*. The proposed project would not result in new significant impacts or a substantial increase in the severity of impacts associated with altering the existing drainage pattern that could result in erosion or siltation that were analyzed in the SAPP EIR.

ii. *Substantially increase the rate or amount of surface runoff in a manner which would result in flooding on- or offsite?*

The SAPP EIR concluded that impacts associated with an increase in the rate or amount of surface runoff in a manner which would result in flooding on- or offsite would be less than significant.

Impervious surfaces associated with the proposed project would increase over existing conditions, which could result in an increased amount of runoff. Structural or Treatment Control best management practices (BMPs) would be required for the proposed project. Construction of the proposed project would involve activities that may temporarily alter drainage patterns. However, these activities are temporary, and the proposed project would adhere to the SWPPP prepared for the approved project, which would reduce potential impacts on drainage patterns or result in flooding. After project construction is complete, drainage patterns would be similar to existing conditions. The proposed project would not significantly alter established drainage patterns or significantly increase the amount of runoff. Furthermore, the proposed project would be designed to include features that would capture runoff. Roof runoff would be discharged from roofs via downspouts into volume-based planter boxes, and planter boxes would be sized adequately to detain and treat the required volume. In addition, proprietary biofiltration units (modular wetlands) would manage stormwater runoff from ground level areas. Further, compliance with General Plan policies INC 8.4 (Runoff pollution prevention) and INC 8.7 (Stormwater quality) would reduce the volume of stormwater runoff. Therefore, impacts would be *less than significant*. The proposed project would not result in new significant impacts or a substantial increase in the severity of impacts associated with runoff that were analyzed in the SAPP EIR.

iii. *Create or contribute runoff water which would exceed the capacity of existing or planned stormwater drainage systems or provide substantial additional sources of polluted runoff?*

The SAPP EIR concluded that impacts associated with runoff water which would exceed the capacity of existing or planned stormwater drainage systems or provide substantial additional sources of polluted runoff would be less than significant.

Construction activities and operation of the proposed project have the potential to introduce contaminants to stormwater. However, the proposed project would be required to comply with existing NPDES permits for construction and post-construction, as well as compliance with

applicable General Plan policies. High capacity bio-filtration BMPs would be utilized for stormwater treatment. The proposed project would increase the amount of impervious surface by approximately 4,315 square feet. The increase in impervious surface could increase stormwater runoff rates and volumes, potentially resulting in degradation of water quality in receiving waters; however, the project is exempt from hydromodification management requirements. Planter boxes, a LID-based treatment system, would be used to treat roof runoff from the building and proprietary biofiltration units (modular wetlands), non-LID treatment systems, will be used to treat ground-level areas. Ground-level surface runoff would enter the modular wetland biofiltration units and discharge to the City's storm drain system. The project would rely on the *Adopted California BMP Handbook* method for volume-based calculations and the Uniform Intensity Approach for flow-based calculations. Further, Mitigation Measure UTL-3 requires a project-specific analysis of the stormwater infrastructure adjacent and downstream of the project site to identify any impacts to the stormwater system and determine if any upgrades or improvements to the City's stormwater infrastructure are required. Therefore, impacts associated with the capacity of existing or planned stormwater drainage systems or additional sources of polluted runoff would be **less than significant**. The proposed project would not result in new significant impacts or a substantial increase in the severity of impacts associated with additional sources of polluted runoff that could result in erosion or siltation that were analyzed in the SAPP EIR.

iv. Impede or redirect flood flows?

The SAPP EIR concluded that new development under the approved project would not impede or redirect flood flows and impacts would be less than significant.

According to the Federal Emergency Management Agency (FEMA) Flood Insurance Rate Map, the project site is not located within a floodway or floodplain. The project site is located within *Zone X*, defined as an area of minimal flood hazard, and outside of the FEMA 100-year floodplain (FEMA 2020). Development associated with the proposed project would not occur in an area subject to flooding. Therefore, the proposed project would not impede or redirect flood flows, and impacts would be **less than significant**. The proposed project would not result in new significant impacts or a substantial increase in the severity of impacts associated with impeding or redirecting flood flows that were analyzed in the SAPP EIR.

d. In flood hazard, tsunami, or seiche zones, risk release of pollutants due to project inundation?

The SAPP EIR identified that new development under the approved project could be placed in flood zones; however, compliance with existing programs and regulations would reduce impacts to a less-than-significant level. Therefore, the SAPP EIR concluded that impacts associated with risk release of pollutants due to project inundation would be less than significant.

As noted above, according to the FEMA Flood Insurance Rate Map, the project site is not located within a floodway or floodplain. The project site is located within *Zone X*, an area of minimal flood hazard (FEMA 2020). The proposed project is located approximately 2 miles southwest of Shoreline Lake and approximately 17 miles from the coast; therefore, the SAPP area would not be inundated by a seiche or a tsunami. Therefore, impacts associated with the release of pollutants due to project inundation would be **less than significant**. The proposed project would not result in new significant impacts or a substantial increase in the severity of impacts associated with the release of pollutants due to project inundation that were analyzed in the SAPP EIR.

e. Conflict with or obstruct implementation of a water quality control plan or sustainable groundwater management plan?

The Santa Clara Valley Urban Runoff Pollution Prevention Program (SCVURPPP) water quality management plan would apply to the proposed project. The Groundwater Management Plan for the Santa Clara and Llagas Subbasins, which describes Valley Water’s groundwater sustainability goals and the strategies, programs, and activities that support those goals, would also be applicable. As discussed above, the proposed project would be covered under the existing San Francisco Bay Region Municipal Regional Stormwater NPDES permits, which would require the proposed project to implement site design measures and BMPs to reduce or prevent runoff pollution, and would be consistent with the SCVURPPP. The proposed project would comply with the SWPPP and associated construction BMPs to protect water quality. Implementation of water quality control measures and BMPs identified in the SAPP would ensure that water quality standards would be achieved, including the water quality objectives that protect designated beneficial uses of surface and groundwater, as defined in the Basin Plan. Biofiltration BMPs and planter boxes would treat runoff and allow for groundwater infiltration and recharge. Furthermore, compliance with General Plan policies including INC 8.2 (National Pollutant Discharge Elimination System Permit), INC 8.4 (Runoff pollution prevention), INC 8.5 (Site-specific stormwater treatment), and INC 8.7 (Stormwater quality) and actions and applicable COAs including COA FEP-05 (Construction Sediment and Erosion Control Plan) and COA FEP-22 (Stormwater Treatment [C.3]) would reduce this impact to a ***less-than-significant*** level. The proposed project would not result in new significant impacts or a substantial increase in the severity of impacts related to conflicts with or obstructing implementation of the applicable water quality management plans for the region that were analyzed in the SAPP EIR.

Applicable SAPP EIR Mitigation Measures and City Standard Conditions of Approval

SAPP EIR Mitigation Measures

No mitigation measures were identified as required for the proposed project.

Conditions of Approval

The full text of the City’s standard Conditions of Approval applicable to the proposed project are identified below.

COA FEP-05 Construction Sediment and Erosion Control Plan

The applicant shall submit a written plan acceptable to the City which shows controls that will be used at the site to minimize sediment runoff and erosion during storm events. The plan should include installation of the following items where appropriate: (a) silt fences around the site perimeter; (b) gravel bags surrounding catch basins; (c) filter fabric over catch basins; (d) covering of exposed stockpiles; (e) concrete washout areas; (f) stabilized rock/gravel driveways at points of egress from the site; and (g) vegetation, hydroseeding, or other soil stabilization methods for high-erosion areas. The plan should also include routine street sweeping and storm drain catch basin cleaning.

COA FEP-22 Stormwater Treatment (C.3)

This project will create or replace more than ten thousand (10,000) square feet of impervious surface; therefore, stormwater runoff shall be directed to approved permanent treatment controls as described in the City's guidance document entitled, "Stormwater Quality Guidelines for Development Projects." The City's guidelines also describe the requirement to select Low-Impact Development (LID) types of stormwater treatment controls; the types of projects that are exempt from this requirement; and the Infeasibility and Special Projects exemptions from the LID requirement.

The "Stormwater Quality Guidelines for Development Projects" document requires applicants to submit a Stormwater Management Plan, including information such as the type, location, and sizing calculations of the treatment controls that will be installed. Include three stamped and signed copies of the Final Stormwater Management Plan with the building plan submittal. The Stormwater Management Plan must include a stamped and signed certification by a qualified Engineer, stating that the Stormwater Management Plan complies with the City's guidelines and the State NPDES Permit. Stormwater treatment controls required under this condition may be required to enter into a formal recorded Maintenance Agreement with the City.

	Did the Program EIR Identify a Significant Impact and Mitigation Measures?	Do Program EIR Mitigation Measures Apply to the Project?	Does New Information of Substantial Importance Require Preparation of a Supplemental Subsequent EIR?	Is There No New Information of Importance Requiring Preparation of a Supplemental/ Subsequent EIR?
IX. Land Use and Planning				
Would the project:				
a. Physically divide an established community?	<input type="checkbox"/>	<input type="checkbox"/>	<input type="checkbox"/>	<input checked="" type="checkbox"/>
b. Cause a significant environmental impact due to a conflict with any land use plan, policy, or regulation adopted for the purpose of avoiding or mitigating an environmental effect?	<input type="checkbox"/>	<input type="checkbox"/>	<input type="checkbox"/>	<input checked="" type="checkbox"/>

Note: A checked box indicates a “yes” answer.

3.8 Land Use and Planning

a. Would the project physically divide an established community?

The San Antonio Precise Plan (SAPP) EIR found that impacts related to the division of an established community would be less than significant. The physical division of an established community typically refers to the construction of a physical feature, such as a highway or railroad tracks, or removal of a means of access, such as a bridge, that would impair mobility within an existing community or between communities.

The project proposes demolition of two single-story commercial buildings as well as associated surface parking, and construction of a commercial building with open spaces and a below-grade parking garage. Although a building would be constructed in place of the existing two buildings and surface parking, pedestrians and commuters would still be able to navigate around the project site using existing roads and new sidewalks proposed as part of the project. Implementation of the proposed project would not impede movement within the project site and surrounding area. Therefore, the proposed project’s impacts associated with the physical division of an established community would be *less than significant*. The proposed project would not result in new significant impacts or a substantial increase in the severity of impacts regarding the division of an established community that were analyzed in the SAPP EIR.

b. Would the project cause a significant environmental impact due to a conflict with any land use plan, policy, or regulation adopted for the purpose of avoiding or mitigating an environmental effect?

The SAPP EIR found that impacts related to conflicts with applicable land use plans, policies, or regulations would be less than significant. Potential incompatibility or conflicts with land use plans or regulations may arise from placing a particular development or land use at an inappropriate location or as a direct result from a project’s design or scope.

The *City of Mountain View 2030 General Plan* designates the project site as a Mixed-Use Center, which allows for a mix of pedestrian-oriented uses as well as integrated and complementary uses, such as residential, office, or retail uses, to draw visitors from surrounding neighborhoods and the

region. Permitted uses for the project site include offices, retail and personal services, multi-family residences, lodging facilities, entertainment venues, parks, and plazas. The project site is also within the Mixed-Use Center Subarea and the Northwest San Antonio Master Plan Area of the SAPP.

The project site is currently zoned P-40 (San Antonio Precise Plan), which is designed to provide uses or combinations of uses that may be appropriately developed as part of the SAPP area development. Furthermore, the zoning designation allows for a mix of uses, including office, commercial, retail, and residential uses. The existing commercial uses on site are consistent with the existing *City of Mountain View 2030 General Plan* land use designation and zoning for the project site.

As described in Chapter 2, *Project Description*, included in the SAPP is an office development cap to prioritize residential development and balance office development with future housing growth. The SAPP currently stipulates an area-wide maximum of 600,000 square feet of net new office development with up to 400,000 square feet permitted in the Northwest San Antonio Center Master Plan Area. Office development beyond this 400,000 square foot cap will require an amendment to the SAPP. In addition, under the SAPP, the Mixed-Use Center Subarea allows development with a floor area ratio of up to 2.35, of which 0.75 can be office or commercial uses.

The project proposes the construction of a seven-story commercial building with retail and commercial/office space, which, upon completion, would include approximately 12,970 gross square feet of retail space and approximately 169,382 gross square feet of commercial/office space, thereby exceeding the office development cap when accounting for the existing office development in the Northwest San Antonio Center Master Plan Area.

To implement the project, the project applicant proposes an amendment to the SAPP and minor amendments to the SAPP Master Plan for Area 2 to modify the office development cap in the Northwest San Antonio Master Plan area to allow additional office development through the Transfer of Development Rights (TDR) for Public Schools and update the regulations governing TDR for Public Schools. Specifically, the proposed amendment would increase the 400,000-gross-square-foot limit on net new office development within the Northwest San Antonio Master Plan, while maintaining the existing 600,000 gross square feet office development limit in the SAPP. The Mountain View City Council authorized the project site as a receiving site under the City of Mountain View's TDR program with the Los Altos School District. Per the authorization, the project applicant would seek a TDR agreement to identify the project site as a receiving site under the City's TDR program allowing the 150,000-gross-square-foot transfer from the Los Altos School District to be exempt from floor area ratio calculations.

Although the proposed project would exceed the allowable floor area ratio (2.35) and the office development cap with approval of the proposed Precise Plan amendments and TDR agreement, the project would be consistent with the existing land use and zoning designations, and would be required to adhere to the design guidelines and development standards in the SAPP, which include regulations on features such as design, signage, lighting, and landscaping requirements. Therefore, the proposed project's impacts associated with conflicts with any land use plan, policy, or regulation would be **less than significant**. The proposed project would not result in new significant impacts or a substantial increase in the severity of impacts regarding conflicts with any adopted land use plan, policy, or regulation, that were analyzed in the SAPP EIR.

Applicable SAPP EIR Mitigation Measures and City Standard Conditions of Approval

SAPP EIR Mitigation Measures

No mitigation measures were identified as required for the proposed project.

Conditions of Approval

No City standard Conditions of Approval were identified as applicable to the proposed project.

	Did the Program EIR Identify a Significant Impact and Mitigation Measures?	Do Program EIR Mitigation Measures Apply to the Project?	Does New Information of Substantial Importance Require Preparation of a Supplemental Subsequent EIR?	Is There No New Information of Importance Requiring Preparation of a Supplemental/ Subsequent EIR?
X. Noise Would the project:				
a. Generate a substantial temporary or permanent increase in ambient noise levels in the vicinity of the project in excess of standards established in the local general plan or noise ordinance, or applicable standards of other agencies?	<input type="checkbox"/>	<input type="checkbox"/>	<input type="checkbox"/>	<input checked="" type="checkbox"/>
b. Generate excessive groundborne vibration or groundborne noise levels?	<input checked="" type="checkbox"/>	<input checked="" type="checkbox"/>	<input type="checkbox"/>	<input checked="" type="checkbox"/>
c. For a project located within the vicinity of a private airstrip or an airport land use plan or, where such a plan has not been adopted, within two miles of a public airport or public use airport, would the project expose people residing or working in the project area to excessive noise levels?	<input type="checkbox"/>	<input type="checkbox"/>	<input type="checkbox"/>	<input checked="" type="checkbox"/>

Note: A checked box indicates a “yes” answer.

3.9 Noise

Overview of Noise and Sound

Noise is commonly defined as unwanted sound that annoys or disturbs people and potentially causes an adverse psychological or physiological effect on human health. Because noise is an environmental pollutant that can interfere with human activities, an evaluation of noise is necessary when considering the environmental impacts of a proposed project.

Sound is characterized by various parameters, including the rate of oscillation of sound waves (frequency), the speed of propagation, and the pressure level or energy content (amplitude). In particular, the sound pressure level is the most common descriptor used to characterize the loudness of an ambient (existing) sound level. Although the decibel (dB) scale, a logarithmic scale, is used to quantify sound intensity, it does not accurately describe how sound intensity is perceived by human hearing. The human ear is not equally sensitive to all frequencies over the entire spectrum; therefore, noise measurements are weighted more heavily toward frequencies to which humans are sensitive through a process referred to as A-weighting. Table 3.9-1 summarizes typical A-weighted sound levels for different noise sources.

The effects of noise on people generally fit within three categories:

- Subjective effects of annoyance, nuisance
- Interference with activities such as speech, sleep, and learning
- Physiological effects such as hearing loss

Table 3.9-1. Typical A-Weighted Sound Levels

Common Outdoor Activities	Sound Level (dBA)	Common Indoor Activities
	110	Rock band
Jet flyover at 1,000 feet		
	100	
Gas lawnmower at 3 feet		
	90	
Diesel truck at 50 mph at 50 feet		Food blender at 3 feet
	80	Garbage disposal at 3 feet
Noisy urban area, daytime		
Gas lawnmower at 100 feet	70	Vacuum cleaner at 3 feet
Commercial area		Normal speech at 3 feet
Heavy traffic at 300 feet	60	
		Large business office
Quiet urban area, daytime	50	Dishwasher in next room
Quiet urban area, nighttime	40	Theater, large conference room (background)
Quiet suburban area, nighttime		
	30	Library
Quiet rural area, nighttime		Bedroom at night, concert hall (background)
Rustling of leaves	20	
		Broadcast/recording studio
	10	
Lowest threshold of human hearing	0	Lowest threshold of human hearing

Source: Caltrans 2013.

dBA = A-weighted decibel

Environmental noise typically produces effects in the first two categories. Workers in industrial plants generally experience noise in the last category. There is no completely satisfactory way to measure the subjective effects of noise or the corresponding reactions of annoyance and dissatisfaction. A wide variation exists in the individual thresholds of annoyance, and different tolerances to noise tend to develop based on an individual's past experiences with noise. Therefore, an important way of predicting a human reaction to a new noise environment is the way it compares to the existing environment to which one has adapted, the so-called "ambient noise" level. In general, the more a new noise exceeds the previously existing ambient noise level, the less acceptable the new noise will be judged by those hearing it. Human sound perception, in general, is such that a change in sound level of 1 dB cannot typically be perceived by the human ear, a change in sound level of 3 dB is just noticeable, a change of 5 dB is clearly noticeable, and a change of 10 dB is

perceived as doubling or halving the sound level. A doubling of actual sound energy is required to result in a 3 dB (i.e., barely noticeable) increase in noise; in practice, for example, this means that the volume of traffic on a roadway would typically need to double to result in a noticeable increase in noise (Caltrans 2013). To summarize:

- Except in carefully controlled laboratory experiments, a change of 1 dB cannot generally be perceived.
- Outside the laboratory, a 3-dB change is considered just perceivable or barely noticeable.
- A change in level of at least 5 dB is required before any noticeable change in human response would be expected.
- A 10-dB change is subjectively heard as approximately a doubling in loudness and can cause an adverse response.

These relationships occur in part because of the logarithmic nature of sound and the decibel system. The human ear perceives sound in a nonlinear fashion, which is the reason the decibel scale was developed. Because the decibel scale is based on logarithms, two noise sources do not combine in a simple additive fashion but, instead, combine logarithmically. For example, if two identical noise sources produce noise levels of 50 A-weighted decibels (dBA), the combined sound level would be 53 dBA, not 100 dBA.

If the difference between two noise sources is 10 dBA or more, the higher noise source will dominate, and the resultant noise level will be equal to the noise level of the higher noise source. In general, if the difference between two noise sources is 0 to 1 dBA, the resultant noise level will be 3 dBA higher than the higher noise source, or both sources if the sources are equal. If the difference between two noise sources is 2 to 3 dBA, the resultant noise level will be 2 dBA above the higher noise source. If the difference between two noise sources is 4 to 10 dBA, the resultant noise level will be 1 dBA higher than the higher noise source. Specifically, when adding sound levels, the relationships presented in Table 3.9-2 may be used to approximate combined overall sound levels.

Table 3.9-2. Rules for Combining Sound Levels by Decibel Addition

When two decibel values differ by...	...add the following amount to the higher decibel value	Example
0 to 1 dB	3 dB	60 dB + 61 dB = 64 dB
2 to 3 dB	2 dB	60 dB + 63 dB = 65 dB
4 to 9 dB	1 dB	60 dB + 69 dB = 70 dB
10 dB or more	0 dB	60 dB + 75 dB = 75 dB

Source: Caltrans 2013.

The decibel level of a sound decreases (or attenuates) exponentially as the distance from the source of that sound increases. Sound that travels over an acoustically absorptive surface, such as grass, attenuates at a greater rate than sound that travels over a hard surface, such as pavement. The increased attenuation is typically in the range of 1 to 2 dB per doubling of distance. For a point source, such as a stationary compressor or construction equipment, sound typically attenuates at a rate of 6 dB to 7.5 dB per doubling of distance, depending on the intervening surface (e.g. vegetative surface or concrete).

For a line source, such as free-flowing traffic on a freeway, sound typically attenuates at a rate of 3 dB to 4.5 dB per doubling of distance, depending on the intervening surface. Atmospheric conditions, including wind, temperature gradients, and humidity, can change how sound propagates over distance and affect the level of sound received at a given location. The degree to which the ground surface absorbs acoustical energy also affects sound propagation. Barriers, such as buildings and topography, which block the line of sight between a source and receiver, also increase the attenuation of sound over distance.

Solid walls, buildings, and berms can result in noise attenuation in the form of shielding if the line of sight between the source and receiver is blocked. Trees and foliage do not generally result in perceptible reductions in noise levels unless the foliage is sufficiently dense to completely block the view along the propagation path (FHWA 2019). In general, if foliage is less than 10 meters in width, no attenuation occurs. If the foliage is close to 20 meters in thickness and the complete line of sight is blocked between the source and the receiver, attenuation of approximately 1 dB or less would be expected to occur (FHWA 2019).

Community noise environments are generally perceived as quiet when the 24-hour average noise level is below 45 dBA, moderate in the 45 to 60 dBA range, and loud above 60 dBA. Very noisy urban residential areas are around 70 dBA day-night level (L_{dn}) or the Community Noise Equivalent Level (CNEL). Along major thoroughfares, roadside noise levels are typically between 65 and 75 dBA L_{dn} or CNEL. Incremental increases of 3 to 5 dB to the existing 1-hour equivalent sound level (L_{eq}) or the L_{dn} /CNEL are common thresholds for an adverse community reaction to a noise increase. However, there is evidence that incremental thresholds in this range may not be sufficiently protective in areas where noise-sensitive uses are located and the L_{dn} or CNEL is already high (i.e., above 60 dBA). In these areas, limiting noise increases to 3 dB or less is recommended (FTA 2006). Noise intrusions that cause short-term interior noise levels to rise above 45 dBA at night can disrupt sleep. Exposure to noise levels greater than 85 dBA for 8 continuous hours or longer can cause permanent hearing damage.

Overview of Groundborne Vibration

The operation of heavy construction equipment, particularly pile-driving equipment and other impact devices (e.g., pavement breakers), creates seismic waves that radiate along the surface of the ground and downward. These surface waves can be felt as ground vibration. Vibration from the operation of this type of equipment can result in effects that range from annoyance for people to damage for structures.

Perceptible groundborne vibration is generally limited to areas within a few hundred feet of construction activities. As seismic waves travel outward from a vibration source, they cause rock and soil particles to oscillate. The actual distance that these particles move is usually only a few ten-thousandths to a few thousandths of an inch. The rate or velocity (in inches per second) at which these particles move is referred to as peak particle velocity (PPV), the commonly accepted descriptor of vibration amplitude.

Vibration amplitude attenuates (or decreases) over distance. This attenuation is a complex function of how energy is imparted into the ground as well as the soil or rock conditions through which the vibration is traveling (variations in geology can result in different vibration levels).

The following equation is used to estimate the vibration level at a given distance for typical soil conditions (FTA 2006). PPV_{ref} is the reference PPV at 25 feet:

$$PPV = PPV_{ref} \times (25/\text{distance})^{1.5}$$

Table 3.9-3 summarizes typical vibration levels generated by construction equipment at a reference distance of 25 feet as well as other distances, as determined with use of the attenuation equation above.

Table 3.9-3. Vibration Source Levels for Construction Equipment

Equipment	PPV at 25 Feet	PPV at 50 Feet	PPV at 100 Feet
Large bulldozer	0.089	0.0315	0.0111
Auger drill	0.089	0.0315	0.0111
Loaded trucks	0.076	0.0269	0.0095
Jackhammer	0.035	0.0124	0.0044
Small bulldozer	0.003	0.0011	0.0004

Source: Caltrans 2020.

Notes: PPV = peak particle velocity

With regard to potential vibration impacts, guidelines developed by the California Department of Transportation to assess potential vibration-related damage and annoyance effects are applied in this analysis (refer to Table 3.9-4 and Table 3.9-5).

Table 3.9-4. Vibration Annoyance Potential Criteria Guidelines

Human Response	Maximum PPV (inches per second)	
	Transient Sources	Continuous/Frequent Intermittent Sources
Barely perceptible	0.04	0.01
Distinctly perceptible	0.25	0.04
Strongly perceptible	0.90	0.10
Severe	2.0	0.40

Source: Caltrans 2020.

Note: Transient sources create a single, isolated vibration event (e.g., blasting or the use of drop balls). Continuous/frequent intermittent sources include impact pile drivers, pogo-stick compactors, crack-and-seat equipment, vibratory pile drivers, and vibratory compaction equipment.

Table 3.9-5. Vibration Damage Potential Threshold Criteria Guidelines

Structure and Condition	Maximum PPV (inches per second)	
	Transient Sources	Continuous/Frequent Intermittent Sources
Extremely fragile historic buildings, ruins, ancient monuments	0.12	0.08
Fragile buildings	0.2	0.10
Historic and some old buildings	0.5	0.25
Older residential structures	0.5	0.30
New residential structures	1.0	0.50
Modern industrial/commercial buildings	2.0	0.50

Source: Caltrans 2020.

Terminology

A brief summary of the noise and vibration concepts and terminology used in this assessment is provided below.

- **Sound.** A vibratory disturbance transmitted by pressure waves through a medium such as air or water that is capable of being detected by a receiving mechanism such as the human ear or a microphone.
- **Noise.** Sound that is loud, unpleasant, unexpected, or otherwise undesirable.
- **Decibel (dB).** A unitless measure of sound on a logarithmic scale that indicates the squared ratio of the sound pressure amplitude to a reference sound pressure amplitude. The reference pressure is 20 micropascals. Because the decibel scale is based on logarithms, two noise sources do not combine in a simple additive fashion; rather, they combine logarithmically. For instance, if two identical noise sources each produce noise levels of 50 dBA (see definition immediately following), the combined sound level would be 53 dBA, not 100 dBA.
- **A-Weighted Decibel (dBA).** An overall frequency-weighted sound level in decibels that approximates the frequency response of the human ear. The dBA scale is the most widely used for environmental noise assessments.
- **Maximum Sound Levels (L_{max}).** The maximum sound level measured during a given measurement period.
- **Minimum Sound Levels (L_{min}).** The minimum sound level measured during a given measurement period.
- **Equivalent Sound Level (L_{eq}).** The equivalent steady-state sound level that, in a stated period of time, would contain the same acoustical energy. The 1-hour A-weighted equivalent sound level (L_{eq} 1h) is the energy average of A-weighted sound levels occurring during a 1-hour period.
- **Day-Night Level (L_{dn}).** The energy average of the A-weighted sound levels occurring during a 24-hour period, with a 10-dB penalty added to sound levels between 10:00 p.m. and 7:00 a.m.
- **Community Noise Equivalent Level (CNEL).** The energy average of the A-weighted sound levels occurring during a 24-hour period, with 5 dB added to the sound levels occurring during the period from 7:00 p.m. to 10:00 p.m. and 10 dB added to the sound levels occurring during the period from 10:00 p.m. to 7:00 a.m. L_{dn} and CNEL are typically within 1 dBA of each other and, for all intents and purposes, interchangeable.
- **Vibration Velocity Level (or Vibration Decibel Level, VdB).** The root-mean-square velocity amplitude for measured ground motion, expressed in dB.
- **Peak Particle Velocity (PPV).** A measurement of ground vibration, defined as the maximum speed at which a particle in the ground is moving, expressed in inches per second (in/sec).
- **Noise-Sensitive Land Uses.** Noise-sensitive land uses are generally defined as locations where people reside or the presence of unwanted sound could adversely affect use of the land. Noise-sensitive land uses typically include single- and multi-family residential areas, health care facilities, lodging facilities, and schools. Recreational areas where quiet is an important part of the environment can also be considered sensitive to noise. Some commercial areas may be considered noise sensitive as well, such as outdoor restaurant seating areas.

Existing Noise-Sensitive Uses in the Vicinity

The nearest noise-sensitive land uses to the project site are the residences at 2580 and 2590 California Street, which are currently under construction. It is anticipated that construction will be complete for these buildings and that these residences will be occupied during construction and operation of the proposed project. 2580 California Street is approximately 100 feet north of the project site, and 2590 California Street is approximately 200 feet northeast of the project site. Additional residential land uses are farther to the east (to the east of 2590 California Street). These single-family residences, the nearest of which is 163 Pachetti Way, are more than 530 feet east of the project site. Additional multi-family residential land uses are to the southwest of the project site (at 400 San Antonio Road) at distances of approximately 220 feet and more from the project property line. In addition, there are two hotels in the general vicinity of the project site: the Hyatt Centric Mountain View is approximately 350 feet southeast of the project site, and the Residences at San Antonio is approximately 710 feet southeast of the project site. There are also two schools near the project site. The closest of the two is the Community School of Music and Arts at 230 San Antonio Circle, at a distance of 580 feet northwest of the project site.

Applicable Noise Regulations and Policies

As explained in the noise setting in the San Antonio Precise Plan (SAPP) EIR, the noise standards and policies most applicable to the types of noise sources associated with construction and operation of the project are found in the *City of Mountain View 2030 General Plan* (General Plan), the City of Mountain View (City) Municipal Code, and the City's Standard Conditions of Approval (COAs), which are presented in greater detail below.

City of Mountain View 2030 General Plan Noise Element

The General Plan noise acceptability guidelines indicate that outdoor noise levels below 67.5 dBA L_{dn} for office buildings and business commercial and 60 dBA L_{dn} for hotels are normally acceptable. The Noise Element policies that relate to the project are listed below.

Policy NOI 1.1: *Land Use Compatibility.* Use the Outdoor Noise Acceptability Guidelines as a guide for planning and development decisions.

Policy NOI 1.3: *Exceeding Acceptable Noise Thresholds.* If noise levels in the area of a proposed project would exceed normally acceptable thresholds, the City shall require a detailed analysis of proposed noise reduction requirements to determine whether the proposed use is compatible. As needed, noise insulation features shall be included in the design of such projects to reduce exterior noise levels to meet acceptable thresholds, or for uses with no active outdoor use areas, to ensure acceptable interior noise levels.

Policy NOI 1.4: *Site Planning.* Use site planning and project design strategies to achieve the noise level standards in NOI 1.1 (Land Use Compatibility) and in NOI 1.2 (Noise Sensitive Land Uses). The use of noise barriers shall be considered after all practical design-related noise measures have been integrated into the project design.

Policy NOI 1.5: *Major Roadways.* Reduce the noise impacts from major arterials and freeways.

Policy NOI 1.6: *Sensitive Uses.* Minimize noise impacts on noise-sensitive land uses, such as residential uses, schools, hospitals, and child-care facilities.

Policy NOI 1.7: *Stationary Sources.* Restrict noise levels from stationary sources through enforcement of the Noise Ordinance

City of Mountain View Municipal Code

The following sections of the City's Municipal Code are applicable to noise-generating sources associated with the proposed project.

Section 8.70—Construction Noise

- a. Hours of construction. No construction activity shall commence prior to 7:00 a.m. nor continue later than 6:00 p.m., Monday through Friday, nor shall any work be permitted on Saturday or Sunday or holidays unless prior written approval is granted by the chief building official. The term "construction activity" shall include any physical activity on the construction site or in the staging area, including the delivery of materials. In approving modified hours, the chief building official may specifically designate and/or limit the activities permitted during the modified hours.
- b. Modification. At any time before commencement of or during construction activity, the chief building official may modify the permitted hours of construction upon twenty-four (24) hours written notice to the contractor, applicant, developer or owner. The chief building official can reduce the hours of construction activity below the 7:00 a.m. to 6:00 p.m. time frame or increase the allowable hours.
- c. Sign required. The general contractor, applicant, developer or owner shall erect a sign at a prominent location on the construction site to advise subcontractors and material suppliers of the working hours. The sign shall include: address number (minimum twenty-four (24) inches by thirty-six (36) inches in contrasting colors), contact name and number, construction hours, contractor info (as stated on your job card). Any modification of standard hours will require additional signage. The contractor, owner or applicant shall immediately produce upon request any written order or permit from the chief building official pursuant to this section upon the request of any member of the public, the police or city staff.
- d. Violation. Violation of the allowed hours of construction activity can result in a stop work notice and/or a reduction of regular construction hours for the duration of the project. Required signage shall be posted or the site shall be considered in violation of this section of the Code under the direction of the chief building official's order.

Section 21.26—Stationary Equipment Noise

- a. No person shall own or operate on any property any stationary equipment, such as, but not limited to, air compressors, equipment for swimming pools, spas, or air conditioners, which produces a sound level exceeding 55 decibels (dB) (50 dB during the night, 10:00 p.m. to 7:00 a.m.) when measured at any location on any receiving residentially used property, said measurement to utilize a sound level meter equal to or better than an ANSI Standard S 1.4-1971 Type 2 noise level meter.
- b. Any plans submitted for building, plumbing, electrical or mechanical/heating permit for any stationary equipment shall be accompanied by documentation of the equipment noise level when available and by noise mitigating devices or buffers appropriate to achieve the above noise limit. Initial granting of a permit for such equipment shall not affect the obligation of each person owning or operating such equipment for continued compliance with these noise level requirements.
- c. Operation of any equipment, as specified in this section, above the 55 dB limit (50 dB nighttime), may occur only if the owner or operator has obtained a conditional use permit. A permit to operate equipment which exceeds the limit may be granted by the zoning administrator only if it has been demonstrated that such operation will not be detrimental to the health, safety, peace, morals, comfort or general welfare of residents subjected to such noise. The manner of obtaining said permit and the rules governing its issuance and revocation shall be as specified in Mountain View City Code Sec. 36.43 and following, all relating to the issuance of conditional use permits.

City of Mountain View Standard Conditions of Approval

The following standard COAs established by the City are applicable to noise-generating sources associated with the proposed project.

COA PL-149 Mechanical Equipment

The noise emitted by any mechanical equipment shall not exceed a level of 55 dB during the day or 50 dB during the night, 10:00 p.m. to 7:00 a.m., when measured at any location on the adjoining residentially used property.

COA PL-150 Noise Generation

All noise-generating activities (i.e., entertainment or amplified sound) are limited to interior areas only, and the heating, ventilation, and air conditioning system shall be maintained to ensure that all windows and doors can remain closed when the restaurant is in operation.

COA PL-152 Construction Noise Reduction

The following noise reduction measures shall be incorporated into construction plans and contractor specifications to reduce the impact of temporary construction-related noise on nearby properties: (a) comply with manufacturer's muffler requirements on all construction equipment engines; (b) turn off construction equipment when not in use, where applicable; (c) locate stationary equipment as far as practical from receiving properties; (d) use temporary sound barriers or sound curtains around loud stationary equipment if the other noise reduction methods are not effective or possible; and (e) shroud or shield impact tools and use electric-powered rather than diesel-powered construction equipment.

COA PL-186 Work Hours

No work shall commence on the job site prior to 7:00 a.m. nor continue later than 6:00 p.m., Monday through Friday, nor shall any work be permitted on Saturday or Sunday unless prior approval is granted by the Chief Building Official. At the discretion of the Chief Building Official, the general contractor or the developer may be required to erect a sign at a prominent location on the construction site to advise subcontractor and material suppliers of the working hours. Violation of this condition of approval may be subject to the penalties outlined in Section 8.6 of the City Code and/or suspension of building permits.

COA PL-186 fulfills the requirements of Section 8.70, Construction Noise, in the City's Municipal Code.

COA PL-188 Notice of Construction

The applicant shall notify neighbors within 750 feet of the project site of the construction schedule in writing, prior to construction. A copy of the notice and the mailing list shall be submitted prior to issuance of building permits.

COA PL-189 Disturbance Coordinator

The project applicant shall designate a "disturbance coordinator" who will be responsible for responding to any local complaints regarding construction noise. The coordinator (who may be an employee of the general contractor) will determine the cause of the complaint and will require that reasonable measures warranted to correct the problem be implemented. A telephone number of the noise disturbance coordinator shall be conspicuously posted at the construction site fence and on the notification sent to neighbors adjacent to the site.

Impact Discussion

a. *Would the project generate a substantial temporary or permanent increase in ambient noise levels in the vicinity of the project in excess of standards established in the local general plan or noise ordinance, or applicable standards of other agencies?*

Construction of the project would involve multiple noise-generating activities, including demolition of the existing buildings and surface parking lot and use of heavy construction equipment. Noise-generating sources associated with operation of the project would include the occasional testing of a backup emergency generator; a heating, ventilating, and air conditioning (HVAC) system; truck activity in the loading areas; and increased traffic on area roadways. These noise sources are discussed separately below along with any of the City's Standard COAs applicable to each noise source.

Temporary Construction Activity

Federal Highway Administration (FHWA) Roadway Construction Noise Model calculation methods were used to estimate reasonable worst-case combined noise. Noise from the loudest three pieces of equipment proposed for use during a single construction phase was calculated. This project would involve six construction phases: demolition, excavation/shoring/grading, foundation, structure building/exterior systems, site improvements, and final closeout. The nearest noise-sensitive receivers to project construction areas are the apartments currently under construction at 2580 California Street (approximately 100 feet north of the project site). These residences are expected to be occupied during project construction.

During project demolition, the three loudest pieces of equipment proposed for use are two Cat 330 Excavators and a street sweeper. Estimated worst-case noise levels would be 75 dBA L_{eq} at the nearest sensitive receiver. During the excavation, shoring, and grading phase, drilling would occur. Specifically, it is expected that the three loudest pieces of equipment would be three types of auger drill rigs: a Cammachio MC20, a Lo-Ho Drill DH40, and a Delmag RH26. Based on modeling of combined noise levels during this phase, construction noise level from this phase may be as high as 76 dBA L_{eq} at the nearest sensitive receiver. During the foundation phase, the three loudest pieces of equipment expected to operate simultaneously are a concrete pump, a gradall, and a forklift. Noise levels during this phase could be high as 77 dBA L_{eq} at the nearest sensitive receiver.

During the structure building and exterior systems phase, the three loudest pieces of equipment proposed for use are two gradalls and a forklift. At the nearest sensitive receptor, noise levels may be as high as 78 dBA L_{eq} . During the site improvements construction phase, a backhoe and soil compactor may be used, resulting in estimated combined noise levels of up to 72 dBA L_{eq} . In addition, the loudest pieces of equipment proposed for the final closeout phase are two gradalls and a boom lift, which would result in estimated combined noise levels at the nearest sensitive receiver of up to 76 dBA L_{eq} .

In summary, noise generated by project construction could be up to 78 dBA L_{eq} at the nearest sensitive receiver (e.g., during the structure building and exterior systems phase). Refer to Table 3.9-6 for estimated combined noise from equipment proposed from this phase at various distances. Refer to Appendix C for the construction noise modeling results for all construction phases.

Table 3.9-6. Estimated Daytime Construction Noise during Expected Loudest Phase (L_{max} and L_{eq})

Source Data:	Maximum Sound Level (dBA)	Utilization Factor	L_{eq} Sound Level (dBA)
Construction Condition: Building Structure, Exterior Systems			
Source 1: Gradall 1 - Sound level (dBA) at 50 feet =	83	40%	79.0
Source 2: Gradall 2 - Sound level (dBA) at 50 feet =	83	40%	79.0
Source 3: Forklift - Sound level (dBA) at 50 feet =	84	40%	80.0
Calculated Data			
	All Sources Combined – L_{max} sound level (dBA) at 50 feet =		88 L_{max}
	All Sources Combined – L_{eq} sound level (dBA) at 50 feet =		84 L_{eq}
Distance between Source and Receiver (feet)	Geometric Attenuation (dB)	Calculated L_{max} Sound Level (dBA)	Calculated L_{eq} Sound Level (dBA)
50	0	88	84
100	-6	82	78
200	-12	76	72
300	-16	73	69
400	-18	70	66
500	-20	68	64
600	-22	67	63
700	-23	65	61

Source: FHWA 2006.

Geometric attenuation based on 6 dB per doubling of distance.

This calculation does not include the effects, if any, of local shielding or ground attenuation from walls, topography, or other barriers that may reduce sound levels further.

Noise levels are based on source noise levels from the FHWA Roadway Construction Noise Model.

Bold denotes distance and sound levels from the project site to the nearest sensitive receiver.

Note that construction may also involve the use of haul trucks, with up to 80 trucks per day estimated to access the site. Although hauling activity would occur mostly along relatively busy roadways in the project area, hauling activity may result in temporary perceptible increases in noise at sensitive land uses. Therefore, project construction and hauling activities may both result in temporary increases in noise in the general project vicinity during daytime hours.

Although construction activity would result in elevated noise levels at nearby land uses, construction noise would be temporary, intermittent, and periodic and would primarily occur during daytime hours when people are less sensitive to noise. Also, COA PL-152 requires construction contractors to implement measures to minimize the exposure of offsite receptors to noise generated by construction equipment. In addition, COA PL-188 requires the project applicant to give advance notice of construction activity to neighbors within 750 feet of the project site and COA PL-189 requires the applicant to establish a disturbance coordinator to address any concerns about construction noise and implement reasonable measures to limit noise exposure. Moreover, because construction activity would only occur between 7:00 a.m. and 6:00 p.m. on weekdays, as required by both COA PL-186 and Section 8.70 of the City’s Municipal Code, construction noise would be generated only during daytime hours when people are less sensitive to noise. Because

daytime construction would be temporary, would involve implementation of all applicable COAs, and would comply with the time-of-day restrictions specified in the City's Municipal Code, construction noise would comply with the applicable local regulations. Therefore, the proposed project's impacts associated with construction noise levels in excess of local standards would be ***less than significant***. The proposed project would not result in new significant impacts or a substantial increase in the severity of impacts regarding construction noise levels in excess of local standards that were analyzed in the SAPP EIR.

HVAC Equipment Operation

The SAPP EIR explains that all stationary sources of noise on land uses developed under the SAPP would be required to comply with the daytime and nighttime noise standards established in Section 21.26 of the City's Municipal Code. This is stated in General Plan Policy NOI 1.7 and is also required by COA PL-149. Therefore, noise impacts from stationary noise sources were not evaluated extensively in the SAPP EIR and were assumed to be less than significant.

Noise-generating mechanical equipment at the project site would include HVAC equipment on the rooftop of the building and limited equipment on the exterior of the building at ground level. Although the exact make and model of the HVAC equipment have not been determined at the time of writing this document, a typical HVAC unit, which includes condensing units and fans, produces sound levels in the range of 70 to 75 dB at 50 feet (Hoover & Keith, Inc. 2000). These units will be placed on the roof, which sits 95 feet above the ground. Assuming no intervening buildings, barriers, or topography, The higher end of this estimated noise range, 75 dB at 50 feet, would attenuate to the City's daytime noise standard of 55 dB at a distance of 475 feet, and to the City's nighttime standard of 50 dB at a distance of 850 feet,. Therefore, without implementation of noise reduction measures, there would be the potential for noise generated by HVAC equipment at the project site to expose nearby residences to noise levels in excess of thresholds. Specifically, the new mixed-use development 100 feet north of the project site at 2580 and 2590 California Street, as well as the residential land use 220 feet southwest of the project site at 400 San Antonio Street, could be exposed to noise levels that exceed the daytime and nighttime noise standards established in Section 21.26 of the City's Municipal Code before accounting for noise attenuation. There would also be the potential for unattenuated noise generated by HVAC equipment to expose residents at sensitive uses farther from these distances to noise levels in excess of the applicable criteria. However, the mechanical roof top equipment will be located behind a mechanical screen, which would help reduce noise somewhat, and the limited equipment at the ground level will be placed on Silicon Way, interior to the project site and away from sensitive receptors.

Although unattenuated HVAC noise based on the modeling assumptions above may result in noise levels in excess of limits, the project's HVAC system would be required to comply with COA PL-149 (Mechanical Equipment), which requires that noise emitted by any mechanical equipment not exceed a level of 55 dB during the day (7:00 a.m. to 10:00 p.m.) or 50 dB during the night (10:00 p.m. to 7:00 a.m.) when measured at any location on a residential property. Therefore, the building's HVAC equipment would be required to include design features such as enclosures or shielding around noise-generating equipment. Furthermore, relatively quiet HVAC models or mufflers or silencers on exhaust fans would be required to ensure compliance with COA PL-149. Implementation of these measures would be expected to reduce HVAC equipment noise to below the applicable standards. Adherence to COA PL-149 would ensure that noise from project HVAC equipment would not exceed the applicable thresholds at residential land uses. Therefore, the proposed project's impacts associated with HVAC equipment operation noise levels in excess of local

standards would *be less than significant*. The proposed project would not result in new significant impacts or a substantial increase in the severity of impacts regarding HVAC equipment operation noise levels in excess of local standards that were analyzed in the SAPP EIR.

Testing of the Emergency Backup Generator

The project would also include an emergency backup generator. Noise from the use of backup generators is generally considered exempt when used during an emergency. However, the project emergency backup generator would be operated occasionally for testing and maintenance. While the size, make, and model of the generator are not known at the time of writing this document, it is expected that the project generator would have a 500-kilowatt capacity. As an example, a Cummins Model QSX15 500-kilowatt generator can generate an estimated noise level of 89 dB at a reference distance of 7 meters (Cummins, Inc. 2015), which is equivalent to 82 dB at 50 feet.

As is the case for the project's HVAC equipment, the backup generator would be required to comply with COA PL-149 (*Mechanical Equipment*), which requires that noise emitted by any mechanical equipment not exceed a level of 55 dB during the day (7:00 a.m. to 10:00 p.m.) or 50 dB during the night (10:00 p.m. to 7:00 a.m.) when measured at any location on a residential property. The proposed backup generator would be located within a ground floor room interior to the building, which would somewhat reduce noise, especially from the engine of the generator. Note that generator noise is made of both engine noise and exhaust noise, and the diesel exhaust is typically piped or exhausted to the external of the building. Therefore, because exhaust noise may not be substantially reduced, enclosing the generator in an interior room may not reduce noise from the generator to below significance criteria. Compliance with COA PL-149 (*Mechanical Equipment*), however, would ensure that overall noise levels from generator testing would be reduced to below the applicable significance criteria of 55 dB during the day (7:00 a.m. to 10:00 p.m.) and 50 dB during the night (10:00 p.m. to 7:00 a.m. Therefore, the proposed project's impacts associated with noise levels in excess of local standards would be *less than significant*. The proposed project would not result in new significant impacts or a substantial increase in the severity of impacts regarding noise levels in excess of local standards that were analyzed in the SAPP EIR. .

Truck Loading/Unloading Activity

Once operational, it is expected that up to five daily deliveries to the project site, in the form of medium and or heavy trucks, could occur. Although loading activity generates noise, the loading and unloading of goods is a common occurrence in urban environments. In addition, project loading activities would occur predominantly during daytime hours when people are less sensitive to noise. Furthermore, the project loading dock is proposed to be on the southern perimeter of the project site, approximately 100 feet east of San Antonio Road. Therefore, loading activities would be shielded from the residences north of the project site. In addition, the line of sight between the residences at 400 San Antonio Road would be largely blocked by intervening buildings. Thus, intermittent noise from loading and unloading activities (e.g., an estimated five per day, spread out over a given day) at the project site would not be expected to result in a substantial increase in the ambient noise levels in the project area. Therefore, the proposed project's impacts associated loading activity noise on nearby noise sensitive land uses would be *less than significant*. The proposed project would not result in new significant impacts or a substantial increase in the severity of impacts regarding loading activity noise on nearby noise sensitive land uses that were analyzed in the SAPP EIR.

Traffic Noise

Because the project includes development of a specific commercial building, a project-level analysis of traffic noise is provided here to determine whether vehicle trips associated with the project would result in traffic noise impacts.

Once operational, the project would lead to an increase in traffic in the vicinity of the project site, as detailed in Section 3.13. Project-specific traffic data, including average daily traffic volumes, were provided by Fehr & Peers (see Appendix D). Modeling was conducted for existing and existing plus-project conditions to estimate traffic noise increases resulting from project implementation along roadway segments in the project vicinity.

When assessing traffic noise impacts, the following thresholds are applied to determine the significance of project-related traffic noise increases:

1. An increase of more than 5 dBA is considered a significant traffic noise increase, regardless of the existing ambient noise level.
2. In places where the existing or resulting noise environment is “conditionally acceptable,” “normally unacceptable,” or “clearly unacceptable,” based on the City Land Use Compatibility Guidelines, any noise increase greater than 3 dBA is considered a significant traffic noise increase.

According to the General Plan Noise Element, a noise level of up to 60 dBA L_{dn} is considered normally acceptable for multi-family residential land uses, and 55 dBA L_{dn} is considered normally acceptable for single-family residential land uses.

As previously discussed, a 10-percent increase in traffic equates to less than a 1-dB (approximately 0.4 dB) increase in noise. A change in sound level of 1 dB is not typically perceived by the human ear and is below the substantial increase criteria for traffic noise impacts. Therefore, roadway segments with less than a 10-percent change would not experience a substantial increase in noise (either a 3- or 5-dB increase, depending on existing noise levels) or significant traffic noise impacts. Because no roadway segments analyzed in the traffic analysis would experience a 10-percent or more increase in traffic with project implementation, only roadway segments relatively close to the project site were quantitatively modeled.

Traffic noise modeling was conducted using a spreadsheet based on the FHWA Traffic Noise Model, version 2.5. This spreadsheet calculates the traffic noise level at a fixed distance from the centerline of a roadway, based on the traffic volume, roadway speed, and vehicle mix predicted to occur under each condition. Traffic noise was evaluated in terms of how project-related traffic noise increases could affect existing noise-sensitive land uses as well as proposed onsite sensitive land uses in the project area. Refer to Table 3.9-7 for the traffic noise modeling results.

As shown in Table 3.9-5, modeling demonstrated that noise levels along the adjacent segments would increase by a maximum of 0.2 dB as a result of project implementation. As described previously, a 3-dB increase is considered barely noticeable and would not constitute a significant increase in noise. An increase of 0.2 dB would not be considered substantial. Therefore, the proposed project’s impacts associated with traffic noise on off-site noise sensitive land uses would be **less than significant**. The proposed project would not result in new significant impacts or a substantial increase in the severity of impacts regarding traffic noise on off-site noise sensitive land uses that were analyzed in the SAPP EIR. .

Table 3.9-7. Traffic Noise Levels along Roadway Segments Adjacent to the Project Site

Roadway	Segment Location	Existing	Existing	Change (dB)
		L _{dn}	plus Project L _{dn}	
California Street	West of San Antonio Road	62.3	62.4	0.1
California Street	Between San Antonio Road and north driveway	65.1	65.3	0.2
California Street	Between north driveway and Pachetti Way	65.1	65.2	0.1
California Street	East of Pachetti Way	63.4	63.5	0.1
San Antonio Road	North of California Street	69.6	69.7	0.1
San Antonio Road	Between California Street and west driveway	66.3	66.4	0.2
San Antonio Road	Between west driveway and Miller Avenue	66.3	66.4	0.1
San Antonio Road	Between Miller Avenue and Fayette Drive	65.4	65.5	0.1
San Antonio Road	South of Fayette Drive	65.7	65.8	0.1

Source: The complete dataset of traffic noise modeling results is included in Appendix C.

b. Would the project generate excessive groundborne vibration or groundborne noise levels?

Project-related demolition and construction would involve the use of heavy equipment that generates ground vibration. The most vibration-intensive equipment proposed for use during project construction are a pile driver and an auger drill. These and other types of heavy equipment create seismic waves that radiate along the surface of the ground and downward. These surface waves can be felt as ground vibration. Vibration from the operation of this type of equipment can result in effects that include damage to structures and annoyance to people.

Vibration amplitudes are commonly expressed two different ways: PPV and root-mean-square vibration velocity. PPV and root-mean-square vibration velocity are normally described in in/sec or in millimeters per second. PPV is defined as the maximum instantaneous positive or negative peak of a vibration signal. PPV is typically used in the monitoring of transient and impact vibration and has been found to correlate well to the stresses experienced by buildings (FTA 2018; Caltrans 2020).

Vibration amplitude attenuates (or decreases) over distance. This attenuation is a complex function of how energy is imparted into the ground as well as the soil or rock conditions through which the vibration is traveling (variations in geology can result in different vibration levels).

With regard to vibration-related annoyance, a significant vibration impact related to sleep disturbance could occur when nighttime construction activities generate vibration levels that are strongly perceptible (i.e., PPV of 0.1 in/sec) (as shown in Table 3.9-4) at locations where people typically sleep. Sleep disturbances from vibration typically occur only if residences are very close to nighttime ground-disturbing construction activities. The nearest residential land uses would be approximately 100 feet north of the project site. However, COA PL-186 (which limits construction activity to the hours of 7:00 a.m. to 6:00 p.m., and enforces Section 8.70 of the City's Municipal Code) would be implemented. Therefore, because no nighttime construction activities are proposed, project-related demolition and construction activity would not result in sleep disturbance at nearby residential land uses.

The most vibration-intensive equipment proposed for use during project construction are a large bulldozer and an auger drill, both of which have a reference vibration level of 0.089 PPV in/sec at a distance of 25 feet. This equipment could be operating as close as 100 feet from the nearest occupied residential land use during daytime hours. At a distance of 100 feet, the vibration level from an auger drill and a large bulldozer would be reduced to approximately 0.011 PPV in/sec. This is well below the strongly perceptible criterion of 0.1 PPV in/sec and the distinctly perceptible criterion of 0.04 PPV in/sec. Therefore, even during daytime hours, construction-related vibration would be unlikely to result in substantial levels of perceptible vibration. Vibration-related annoyance impacts would be less than significant.

Regarding potential vibration-related damage effects, equipment could operate as close as 25 feet from the nearest existing structure. The nearest offsite structure is the relatively new commercial office building adjacent south of the project site at 391 San Antonio Road. As shown in Table 3.9-1, the vibration level from a large bulldozer or auger drill at a distance of 25 feet would be approximately 0.089 PPV in/sec. This is below the vibration-related damage criterion for modern industrial/commercial buildings of 0.5 PPV in/sec, as shown in Table 3.9-5 (Caltrans 2020). Because project-related activities would not exceed the applicable damage criterion at nearby structures, vibration-related damage impacts would be less than significant.

The analysis under Impact NOISE-1 of the SAPP EIR determined that construction activities associated with development and redevelopment under the SAPP could result in exposure of sensitive land uses to excessive levels of ground vibration, and required implementation of Mitigation Measure NOISE-1, which pertained to notification of residents if pile driving is anticipated, phasing high-vibration generating construction activities, and avoiding other high-impact construction activities where feasible. The SAPP EIR determined that implementation of Mitigation Measure NOISE-1 would ensure that the exposure of sensitive receptors to excessive groundborne vibration levels from demolition and construction activities would be sufficiently mitigated to be less than significant.

In summary, the project-related demolition and construction activity would not result in structural damage to nearby buildings or sleep disturbance at nearby residential land uses. Moreover, development of the project would not include the long-term operation of any source of ground vibration atypical of developed urban areas. Therefore, with SAPP EIR mitigation measure applied, similar to those impacts identified in the SAPP EIR, the proposed project's impacts associated with vibration would be less than significant. The proposed project would not result in new significant impacts or a substantial increase in the severity of impacts regarding vibration that were analyzed in the SAPP EIR.

c. For a project located within the vicinity of a private airstrip or an airport land use plan or, where such a plan has not been adopted, within two miles of a public airport or public use airport, would the project expose people residing or working in the project area to excessive noise levels?

The noise setting in the SAPP EIR explains that the SAPP area, and therefore the Plan Area of the Village at San Antonio Phase III, lies outside of the 55 dB CNEL noise contour of the Palo Alto Airport and outside the 60 dB CNEL noise contour of the Moffett Federal Airfield. The most recent comprehensive land use plans for these airports show that this remains the case (Santa Clara County 2016a, 2016b). The SAPP EIR also explains that the SAPP area is approximately 12 miles from San Jose International Airport and approximately 18 miles from San Francisco International Airport and, therefore, concludes that aircraft noise from these four nearest airports is not a substantial contributor to the existing noise environment in the plan area.

Development of office and retail land uses at the project site would not result in the exposure of people to excessive noise levels from aircraft. Therefore, the proposed project's impacts associated with the exposure of people to excessive aircraft noise would be *less than significant*. The proposed project would not result in new significant impacts or a substantial increase in the severity of impacts regarding the exposure of people to excessive aircraft noise that were analyzed in the SAPP EIR.

Applicable SAPP EIR Mitigation Measures and City Standard Conditions of Approval

SAPP EIR Mitigation Measures

The full text of the SAPP EIR mitigation measures applicable the proposed project are identified below.

Mitigation Measure NOISE-1

The following language shall be included as a Condition of Approval for new projects associated with implementation of the SA Precise Plan:

- In the event that pile driving would be required for any proposed project within the SA Precise Plan area, all residents within 300 feet of the project site shall be notified of the schedule for its use a minimum of one week prior to its commencement. The contractor shall implement "quiet" pile driving technology (such as pre-drilling of piles, the use of more than one pile driver to shorten the total pile driving duration, or the use of portable acoustical barriers) where feasible, in consideration of geotechnical and structural requirements and conditions.
- To the extent feasible, the project contractor shall phase high-vibration generating construction activities, such as pile-driving/ground-impacting operations, so they do not occur in the same period with demolition and excavation activities in locations where the combined vibrations would potentially impact sensitive areas.
- The project contractor shall select demolition methods not involving impact, where possible (for example, milling generates lower vibration levels than excavation using clam shell or chisel drops).
- The project contractor shall avoid using vibratory rollers and packers near sensitive areas whenever possible.

Conditions of Approval

The full text of the City's standard Conditions of Approval applicable to the proposed project are identified below.

COA PL-149 Mechanical Equipment

The noise emitted by any mechanical equipment shall not exceed a level of 55 dB during the day or 50 dB during the night, 10:00 p.m. to 7:00 a.m., when measured at any location on the adjoining residentially used property.

COA PL-150 Noise Generation

All noise-generating activities (i.e., entertainment or amplified sound) are limited to interior areas only, and the heating, ventilation, and air conditioning system shall be maintained to ensure that all windows and doors can remain closed when the restaurant is in operation.

COA PL-152 Construction Noise Reduction

The following noise reduction measures shall be incorporated into construction plans and contractor specifications to reduce the impact of temporary construction-related noise on nearby properties: (a) comply with manufacturer's muffler requirements on all construction equipment engines; (b) turn off construction equipment when not in use, where applicable; (c) locate stationary equipment as far as practical from receiving properties; (d) use temporary sound barriers or sound curtains around loud stationary equipment if the other noise reduction methods are not effective or possible; and (e) shroud or shield impact tools and use electric-powered rather than diesel-powered construction equipment.

COA PL-186 Work Hours

No work shall commence on the job site prior to 7:00 a.m. nor continue later than 6:00 p.m., Monday through Friday, nor shall any work be permitted on Saturday or Sunday unless prior approval is granted by the Chief Building Official. At the discretion of the Chief Building Official, the general contractor or the developer may be required to erect a sign at a prominent location on the construction site to advise subcontractor and material suppliers of the working hours. Violation of this condition of approval may be subject to the penalties outlined in Section 8.6 of the City Code and/or suspension of building permits.

COA PL-188 Notice of Construction

The applicant shall notify neighbors within 750 feet of the project site of the construction schedule in writing, prior to construction. A copy of the notice and the mailing list shall be submitted prior to issuance of building permits.

COA PL-189 Disturbance Coordinator

The project applicant shall designate a "disturbance coordinator" who will be responsible for responding to any local complaints regarding construction noise. The coordinator (who may be an employee of the general contractor) will determine the cause of the complaint and will require that reasonable measures warranted to correct the problem be implemented. A telephone number of the noise disturbance coordinator shall be conspicuously posted at the construction site fence and on the notification sent to neighbors adjacent to the site.

	Did the Program EIR Identify a Significant Impact and Mitigation Measures?	Do Program EIR Mitigation Measures Apply to the Project?	Does New Information of Substantial Importance Require Preparation of a Supplemental Subsequent EIR?	Is There No New Information of Importance Requiring Preparation of a Supplemental/ Subsequent EIR?
XI. Population and Housing				
Would the project:				
a. Induce substantial unplanned population growth in an area, either directly (for example, by proposing new homes and businesses) or indirectly (for example, through extension of roads or other infrastructure)?	<input type="checkbox"/>	<input type="checkbox"/>	<input type="checkbox"/>	<input checked="" type="checkbox"/>
b. Displace substantial numbers of existing people or housing, necessitating the construction of replacement housing elsewhere?	<input type="checkbox"/>	<input type="checkbox"/>	<input type="checkbox"/>	<input checked="" type="checkbox"/>

Note: A checked box indicates a “yes” answer.

3.10 Population and Housing

a. *Would the project induce substantial unplanned population growth in an area, either directly (for example, by proposing new homes and businesses) or indirectly (for example, through extension of roads or other infrastructure)?*

The San Antonio Precise Plan (SAPP) EIR found that impacts related to direct and indirect substantial unplanned population growth would be less than significant.

Construction

Construction of the project would result in a temporary increase in the number of construction-related job opportunities in the Plan Area and surrounding local area. However, the opportunities provided by project construction would most likely not result in construction workers relocating their households to the project vicinity because these jobs would be temporary. It is expected that construction workers would be drawn from the construction labor force already residing in Mountain View and the surrounding communities. However, the construction jobs produced by this project would be new jobs, and would slightly alter the balance of jobs to employed residents in Mountain View. This effect would not be permanent, and would not be expected to change the current ratio of 2.07 jobs per employed resident.¹ Accordingly, employment opportunities provided by construction of the project would not generate substantial population growth. Therefore, the proposed project’s impacts associated with unplanned population growth during construction activities would be **less than significant**. The proposed project would not result in new significant impacts or a substantial increase in the severity of impacts regarding unplanned population growth during construction activities that were analyzed in the SAPP EIR.

¹ In 2019, the City of Mountain View had 101,965 jobs and 49,084 employed residents, a ratio of 2.08 jobs for every employed resident (U.S. Census Bureau 2020a, 2020b).

Operation

The project does not include the development of housing and therefore would not directly induce population growth. As such, the proposed project would not generate substantial direct population as a result of project operation, and the project would not result in new significant impacts or a substantial increase in the severity of impacts regarding substantial direct population that were analyzed in the SAPP EIR.

The SAPP EIR determined that there would be an increase of approximately 3,695 jobs as a result of development of commercial and service uses under the SAPP. Approximately 12 individuals are currently employed on the project site. With implementation of the project, a total of approximately 1,500 office employees would work at the project site upon completion and occupancy of the new building. This would result in a net increase in employment amounting to 1,488 employees, or approximately 40 percent of the projected employment growth under the SAPP. The number of employees associated with the project would be within the Plan Area projected growth. The net increase in 1,488 employees could potentially cause people to move to the area or surrounding communities; however, many of the new jobs would likely be occupied by those already living in the area or surrounding cities and, as a result, the increase in jobs is not likely to result in a substantial number of people moving into the Plan Area. Furthermore, as detailed in the SAPP EIR, population growth, both direct and indirect, associated with buildout of the Plan Area would not be considered substantial or adverse, based on the developed nature of Mountain View and the proximity of the Plan Area to employment centers and transit infrastructure. Population growth that would occur as a result of buildout under the SAPP would be consistent with the *City of Mountain View 2030 General Plan* goal of supporting transit-oriented development along transit corridors, and would primarily occur as intensification of uses and infill.

The project would require the extension of certain utilities, which could indirectly induce growth in adjacent areas. However, the proposed project is an infill project, and the project site and surrounding areas are already developed with residential, commercial, and office uses as well as associated infrastructure to serve these uses. Furthermore, the proposed project would not require the construction of any new roads. Therefore, the proposed project's impacts associated with substantial unplanned population growth during operation activities would be ***less than significant***. The proposed project would not result in new significant impacts or a substantial increase in the severity of impacts regarding substantial unplanned population growth during operation activities that were analyzed in the SAPP EIR.

b. Would the project displace substantial numbers of existing people or housing, necessitating the construction of replacement housing elsewhere?

The SAPP EIR found that impacts related to displacement of substantial numbers of existing housing or people would be less than significant.

The project site is currently composed of a commercial office building, a retail building, and approximately 45 surface parking spaces. No residential uses are currently located on the project site. No housing or residents would be displaced as a result of the project. Therefore, the proposed project would have no impact associated with the displacement of a substantial number of existing people or housing. The proposed project would not result in new significant impacts or a substantial increase in the severity of impacts regarding the displacement of existing people or housing that were analyzed in the SAPP EIR.

Applicable SAPP EIR Mitigation Measures and City Standard Conditions of Approval

SAPP EIR Mitigation Measures

No mitigation measures were identified as required for the proposed project.

Conditions of Approval

No City standard Conditions of Approval were identified as applicable to the proposed project.

	Did the Program EIR Identify a Significant Impact and Mitigation Measures?	Do Program EIR Mitigation Measures Apply to the Project?	Does New Information of Substantial Importance Require Preparation of a Supplemental Subsequent EIR?	Is There No New Information of Importance Requiring Preparation of a Supplemental/ Subsequent EIR?
XII. Public Services and Recreation				
Would the project:				
a. Result in substantial adverse physical impacts associated with the provision of new or physically altered governmental facilities, need for new or physically altered governmental facilities, the construction of which could cause significant environmental impacts, in order to maintain acceptable service ratios, response times, or other performance objectives for any of the public services:	<input type="checkbox"/>	<input type="checkbox"/>	<input type="checkbox"/>	<input checked="" type="checkbox"/>
i. Fire protection?	<input type="checkbox"/>	<input type="checkbox"/>	<input type="checkbox"/>	<input checked="" type="checkbox"/>
ii. Police protection?	<input type="checkbox"/>	<input type="checkbox"/>	<input type="checkbox"/>	<input checked="" type="checkbox"/>
iii. Schools?	<input type="checkbox"/>	<input type="checkbox"/>	<input type="checkbox"/>	<input checked="" type="checkbox"/>
iv. Parks?	<input type="checkbox"/>	<input type="checkbox"/>	<input type="checkbox"/>	<input checked="" type="checkbox"/>
v. Other public facilities?	<input type="checkbox"/>	<input type="checkbox"/>	<input type="checkbox"/>	<input checked="" type="checkbox"/>
b. Increase the use of existing neighborhood and regional parks or other recreational facilities such that substantial physical deterioration of the facility would occur or be accelerated?	<input type="checkbox"/>	<input type="checkbox"/>	<input type="checkbox"/>	<input checked="" type="checkbox"/>
c. Include recreational facilities or require the construction or expansion of recreational facilities which might have an adverse physical effect on the environment?	<input type="checkbox"/>	<input type="checkbox"/>	<input type="checkbox"/>	<input checked="" type="checkbox"/>

Note: A checked box indicates a “yes” answer.

3.11 Public Services and Recreation

a. Would the project result in substantial adverse physical impacts associated with the provision of new or physically altered governmental facilities, need for new or physically altered governmental facilities, the construction of which could cause significant environmental impacts, in order to maintain acceptable service ratios, response times, or other performance objectives for any of the public services:

i. Fire protection?

The San Antonio Precise Plan (SAPP) EIR found that impacts related to fire protection services would be less than significant.

Fire protection and emergency services to the project site and Plan Area are provided by the Mountain View Fire Department (MVFD). MVFD also participates in an automatic aid program with the cities of Sunnyvale, Palo Alto, Los Altos, and the National Aeronautics and Space Administration Ames Fire Department at Moffett Field, in addition to statewide programs and mutual aid programs. MVFD has an established response time goal of 4 minutes (from dispatch) for “Medical Code Three”

calls (i.e., those requiring expedited transport). During the 2018 to 2019 fiscal year (July 1, 2018, to June 30, 2019), the most recent fiscal year for which information is available, MVFD regularly met or exceeded this goal. During 2018, MVFD had 87 personnel, including 30 paramedics. MVFD operates five fire stations, the closest of which is Station 3 at 301 North Rengstorff Avenue, approximately 1.3 miles northeast of the Plan Area.

Although the addition of 1,488 net new employees to the project site and larger Plan Area would slightly increase the need for fire protection services from MVFD, the proposed project would be constructed in an area already served by MVFD. In addition, the proposed project would be required to adhere to the City's Standard Conditions of Approval, which require fire protection systems within all proposed buildings and throughout the entire project site, such as fire hydrants, fire extinguishers, and smoke alarms. During construction, the project would be required to adhere to Standard Condition of Approval PW-135, *Miscellaneous—Construction Management Plans*, which requires a construction traffic and parking management plan with the building plans, as well as FD-05, *Fire Protection During Construction*, which requires the building to be connected to a temporary standpipe system during construction to which fire hoses can connect, as the proposed building would be larger than four stories. Furthermore, the project site would be designed to facilitate access for emergency vehicles, which would be able to access the project site from one location on California Street and one location on San Antonio Road. The internal project streets of Silicon Way and Promenade Lane would provide full emergency access around the project site. Response times to the project site and Plan Area would not substantially change with project implementation. Therefore, the proposed project's impacts associated with fire protection would be ***less than significant***. The proposed project would not result in new significant impacts or a substantial increase in the severity of impacts regarding fire protection that were analyzed in the SAPP EIR.

ii. Police protection?

The SAPP EIR found that impacts related to police protection services would be less than significant.

The Mountain View Police Department (MVPD) provides police services in Mountain View. MVPD operates out of one police station at 1000 Villa Street. MVPD has a staff of 96 sworn and 48.5 non-sworn personnel. In addition, MVPD conducts an active volunteer program, which involves approximately 14 non-sworn volunteers. Each beat is staffed by one officer, with one or two "roving" units who patrol the entire city. Multiple shifts overlap throughout a 24-hour cycle, so there could be up to three officers in one beat at any given time. MVPD separates Mountain View into four beats; the project site and Plan Area are in Beat 2. According to MVPD's 2020 Annual Report (MVPD 2020), officers were dispatched to 5,043 calls within Beat 2.

MVPD's goal is to respond to emergency and Priority 1 calls, which warrant emergency dispatch and are the highest priority, in less than 4 minutes at least 55.5 percent of the time. In 2020, response time to emergency and Priority 1 calls was 4 minutes or less 62.8 percent of the time. However, MVPD's 2020 annual report found that the average citywide response time for events at all priority levels combined for Beats 1 through 4 was 14.3 minutes.

Although the addition of 1,488 net new employees to the project site and larger Plan Area would slightly increase the need for police protection services from MVPD, the proposed project would be constructed in an area already served by MVPD. In addition, the SAPP EIR notes that although development would incrementally increase demands for police protection services, planned development within the Plan Area itself would not directly result in adverse physical impacts associated with the construction of new public facilities because new officers could be housed in

existing police facilities, and no new construction would be required. On this basis, the SAPP EIR found that implementation of the SAPP would have a less-than-significant impact on police protection services and facilities. The project would be consistent with the land uses assumed for the site in the SAPP. Furthermore, the project would be required to adhere to Standard Conditions of Approval FD-43, *Emergency Responder Radio Coverage* to improve onsite security Response times to the project site and Plan Area would not substantially change with project implementation. Therefore, the proposed project's impacts associated with police protection would be ***less than significant***. The proposed project would not result in new significant impacts or a substantial increase in the severity of impacts regarding police protection that were analyzed in the SAPP EIR.

iii. Schools?

The SAPP EIR found that impacts related to schools would be less than significant.

Mountain View is served by three public school districts: Mountain View Whisman School District, Mountain View-Los Altos Union High School District (MVLA UHSD), and Los Altos School District (LASD). The project site and Plan Area are served by elementary and middle schools in LASD and by high schools in MVLA UHSD. The LASD schools that would serve the Plan Area, including the project site, include Santa Rita, Almond, and Covington elementary schools and Egan Junior High School. Los Altos High School, part of MVLA UHSD, would also serve the Plan Area and project site. LASD has a maximum student enrollment capacity of 5,676 students across the elementary and middle schools (LASD 2020), while Los Altos High School has a maximum student enrollment capacity of 1,579. For the 2019–2020 school year, LASD was within its maximum capacity and had a total enrollment of 3,999 students. MVLA UHSD had a total enrollment of 4,548 students, with Los Altos High School currently supporting 2,253 students, resulting in approximately 674 students over the school's capacity (Ed-Data 2021a, 2021b).

According to the SAPP EIR, LASD has a student generation rate of 0.63 elementary and middle school student per single-family detached unit and 0.3 student per multi-family residential unit, and MVLA UHSD has a student generation rate of 0.115 student per single-family detached residential unit and 0.046 student per apartment/attached residential unit. The SAPP EIR projected that 427 additional students would be generated under full implementation of the SAPP, with 57 students being added to MVLA UHSD and 370 students being added to LASD.

The project does not include the development of housing and therefore would not directly induce new student enrollment at the school districts or directly increase enrollment at the school districts beyond their current capacity. However, as described in Section 3.11, *Population and Housing*, the net increase in 1,488 employees could potentially cause people to move to the area or surrounding communities, thereby potentially generating a small number of new students who would attend schools within LASD or MVLA UHSD. It is likely that many of the new employees generated by the proposed project would likely be those already living in the area or surrounding cities and, as a result, the increase in employees to the project site and Plan Area is not likely to result in a substantial number of new students enrolling into the school districts. Nonetheless, as stated above, the SAPP EIR projected that 427 additional students would be generated under full implementation of the SAPP, with 57 students being added to MVLA UHSD and 370 students being added to LASD, thus exceeding MVLA UHSD's capacity.

School districts are authorized under California Government Code Section 65996 and Education Code Section 17620 to levy a development fee on new residential and commercial projects to offset costs associated with new students in districts as a result of new development. The project would be

required to comply with these codes under Standard Condition of Approval BID-44 (*School Impact Fee*). Section 65996 states that the payment of school impact fees, as required by a state or local agency, is deemed full and complete mitigation for school impacts from development. The project would pay the applicable development impact fee, which could be used to help offset the cost of expanding or constructing new school facilities and hiring new personnel, including teachers. It is not expected that the proposed project would generate students such that new facilities would be required. Therefore, the proposed project's impacts associated with schools would be ***less than significant***. The proposed project would not result in new significant impacts or a substantial increase in the severity of impacts regarding schools that were analyzed in the SAPP EIR.

iv. Parks?

The SAPP EIR found that impacts related to parks would be less than significant. Refer to impact b and impact c below for a discussion of the proposed project's impacts on parks and recreational resources.

v. Other public facilities?

The SAPP EIR found that impacts related to community or public facilities would be less than significant.

There is one library in Mountain View, the Mountain View Public Library at 585 Franklin Street. The library was remodeled and expanded in 2018 to meet the needs of Mountain View's growing population. The library provides reference and reader assistance, library programming, internet access, and print and media materials.

The project does not include the development of housing and, therefore, would not directly result in impacts on public facilities, such as the library. However, as described in Section 3.11, *Population and Housing*, the net increase in approximately 1,500 employees could potentially cause people to move to the area or surrounding communities, thereby potentially generating a small number of people who may utilize community or public facilities, including the library. It is likely that many of the new employees generated by the proposed project would be those already living in the area or surrounding cities and, as a result, the increase in employees to the project site and Plan Area is not likely to result in a substantial number of new people utilizing the library, and the library would continue to provide adequate service to the project site, Plan Area, and city at large. In addition, the SAPP EIR determined that population and employment growth associated with buildout and implementation of the SAPP, which accounts for the proposed project, would not result in significant impacts on community facilities. It is not expected that the proposed project would generate a substantial number of new users such that new library or other community facilities would be required. Therefore, the proposed project's impacts associated with other public facilities would be ***less than significant***. The proposed project would not result in new significant impacts or a substantial increase in the severity of impacts regarding other public facilities that were analyzed in the SAPP EIR.

b. Would the project increase the use of existing neighborhood and regional parks or other recreational facilities such that substantial physical deterioration of the facility would occur or be accelerated?

The SAPP EIR found that impacts related to increased use of existing neighborhood and regional parks or other recreational facilities resulting in substantial physical deterioration of the facility would be less than significant.

The city has nearly 1,000 acres of parks and open space as well as an interconnected system of trails that links neighborhoods to parks and other community facilities, including recreational facilities. The city had 13.5 acres of parkland per 1,000 residents in 2011, substantially better than the City standard of 3 acres per 1,000 residents. Two large regional open spaces, Shoreline at Mountain View Regional Park within the North Bayshore Planning Area, and Stevens Creek Trail, account for 80 percent of Mountain View's park and open space area.

There are three parks within 0.5 mile of the project site:

- **Del Medio Park:** Del Medio Park is the closest park to the project site, approximately 0.19 mile west of the site. The approximately 0.38-acre mini park includes a children's playground, swings, outdoor exercise equipment, passive areas, benches, and a picnic area.
- **Monroe Park:** The 0.55-acre Monroe Park is approximately 0.35 mile west of the site at the Palo Alto–Mountain View border. The park includes a playground, benches, and passive areas.
- **Klein Park:** The 1.90-acre Klein Park is approximately 0.45 mile east of the project site. The park includes a basketball court, children's playground, passive areas, and a picnic area.

It is possible that some of the proposed project's employees may use parks, open space, and recreational facilities during lunch or after work, thereby generating a small, indirect increase in park use. However, because the proposed project would not involve the construction of any housing units, it is not anticipated that the proposed project would generate a substantial increase in demand for recreational and park facilities. In addition, with implementation of the project, private and public open space would be provided throughout the site. The streetscape would consist of at-grade and raised planters with built-in seating. Benches, bicycle racks, and lighting would be provided, per City and California Green Building Standards Code requirements. Furthermore, approximately 20,663 square feet of public open space would be provided on the ground floor of the building, including landscaping, seating areas and outdoor dining. A public plaza would be located at the corner of California Street and San Antonio Road as well as an outdoor seating area along Promenade Lane. In addition, approximately 17,715 square feet of private open space would be provided on site, including balconies and landscaping on the upper floors. It is expected that many of the employees would use the onsite open space areas for recreational purposes, which would minimize potential project-related effects on park facility ratios. With incorporation of the proposed open space, the project would ensure that the existing parkland-to-resident ratio would be maintained, which would minimize the potential for substantial park facility deterioration resulting from the increased employee population at the project site. Therefore, the proposed project's impacts associated with existing recreational resources and the physical deterioration of them would be less than significant. The proposed project would not result in new significant impacts or a substantial increase in the severity of impacts regarding existing recreational resources and physical deterioration that were analyzed in the SAPP EIR.

c. Would the project include recreational facilities or require the construction or expansion of recreational facilities which might have an adverse physical effect on the environment?

The SAPP EIR found that impacts related to recreational facilities would be less than significant.

As described above and in Chapter 2, *Project Description*, the project would include both public and private onsite open space facilities, which would serve as recreational areas for many current and future employees at the project site. As described in the various sections of this document, these onsite recreational areas would not result in significant impacts. Therefore, the proposed project's

impacts associated with the construction or expansion of recreational facilities that might have an adverse physical effect on the environment would be *less than significant*. The proposed project would not result in new significant impacts or a substantial increase in the severity of impacts regarding the construction or expansion of recreational facilities that were analyzed in the SAPP EIR.

Applicable SAPP EIR Mitigation Measures and City Standard Conditions of Approval

Mitigation Measures

No mitigation measures were identified as required for the proposed project.

Conditions of Approval

The full text of the City's standard Conditions of Approval applicable to the proposed project are identified below.

COA BID-44 School Impact Fee

Project is subject to school impact fees. To obtain information, fee estimates, and procedures, please contact the following local school districts: Mountain View Los Altos High School District at www.mvla.net or 650-940-4650; and Mountain View Whisman School District at www.mvwsd.org or 650-526-3500; or Los Altos Elementary School District at www.lasdschools.org or 650-947-1150.

COA FD-43 Emergency Response Radio Coverage

All buildings shall have approved radio coverage for emergency responders within the building. (California Fire Code, Section 510.)

COA PW-135 Construction Management Plans

Upon submittal of the initial building permit and all subsequent building permit submittals, the applicant shall provide a construction traffic and parking management plan with the building plans showing the following:

1. Truck Route: Truck route (to and from project site) for construction and delivery trucks pursuant to City Code Sections 19.58 and 19.59 and which does not include neighborhood residential streets; [OPTIONAL: The use of _____ [enter STREET NAME] shall be minimized];
2. Construction Phasing, Equipment, Storage, and Parking: Show construction vehicles and equipment parking area, material storage and lay-down area, and construction trailer location for each phase of construction. All construction vehicles/equipment and trailer shall be located on-site or at a site nearby (not on a public street or public parking) arranged by the permittee/contractor. Construction equipment, materials, or vehicles shall not be stored or parked on public streets or public parking lots. Construction contractors/workers are required to park on-site or at a private property arranged by the permittee/contractor and shall not be allowed to use neighboring streets for parking/storage; and
3. Sidewalk closure or narrowing is not allowed during any on-site construction activities.

The construction traffic and parking management plan must be approved prior to the issuance of a demolition permit.

	Did the Program EIR Identify a Significant Impact and Mitigation Measures?	Do Program EIR Mitigation Measures Apply to the Project?	Does New Information of Substantial Importance Require Preparation of a Supplemental Subsequent EIR?	Is There No New Information of Importance Requiring Preparation of a Supplemental/ Subsequent EIR?
XIII. Transportation and Traffic				
Would the project:				
a. Conflict with a program, plan, ordinance or policy addressing the circulation system, including transit, roadway, bicycle and pedestrian facilities?	<input checked="" type="checkbox"/>	<input type="checkbox"/>	<input type="checkbox"/>	<input checked="" type="checkbox"/>
b. Conflict or be inconsistent with CEQA Guidelines § 15064.3, subdivision (b)?	<input type="checkbox"/>	<input type="checkbox"/>	<input type="checkbox"/>	<input checked="" type="checkbox"/>
c. Substantially increase hazards due to a geometric design feature (e.g., sharp curves or dangerous intersections) or incompatible uses (e.g., farm equipment)?	<input type="checkbox"/>	<input type="checkbox"/>	<input type="checkbox"/>	<input checked="" type="checkbox"/>
d. Result in inadequate emergency access?	<input type="checkbox"/>	<input type="checkbox"/>	<input type="checkbox"/>	<input checked="" type="checkbox"/>

Note: A checked box indicates a “yes” answer.

3.12 Transportation and Traffic

a. Conflict with a program, plan, ordinance or policy addressing the circulation system, including transit, roadway, bicycle and pedestrian facilities?

The SAPP EIR found that impacts related to conflicts with adopted policies, plans, or programs addressing the circulation system and alternative transportation would be less than significant with implementation of Mitigation Measure TRANS-1, (add a right turn lane at San Antonio Road/California Avenue for the westbound right turn movement or comparable improvement to maintain an acceptable intersection LOS), which has not yet been constructed.

Transit

The project site is within a 0.5-mile walk of rail and transit stops. The San Antonio Caltrain Station is approximately 0.25 mile north of the project site on Showers Drive and operates a total of 92 trains per day between San Jose and San Francisco. The Santa Clara Valley Transportation Agency (VTA) operates bus service within and surrounding the project area. Route 21 operates on Middlefield Road and California Street with two bus stops in the project area at the intersection of California Street and San Antonio Road, and California Street and Pachetti Way. In addition, Route 40 operates on Foothill Expressway and Rengstorff Avenue with one stop to the east of the project site at California Street and Showers Drive. Route 522 also operates near the project area along Manila Drive and Ellis Street. Furthermore, the San Antonio Transit Center on Showers Drive at Latham Street is the transfer station for four regional bus routes (Routes 21, 22, 40, and 522) that serve Santa Clara County.

According to California Public Resources Code Section 21155, a major transit stop is defined as an existing rail or bus rapid transit station or the intersection of two or more major bus routes with a frequency of service interval of 15 minutes or less during peak commute periods. Therefore, the Project is in a transit proximity area because it is within 0.5 mile of a major transit stop. The proposed project’s Transportation Demand Management Plan would encourage and subsidize transit use; and therefore generate transit trips, consistent with state and local policies.

The new ridership generated by the project could be accommodated by existing services. Finally, the small number of new vehicle trips generated by the project would result in a minimal increase in vehicle delay at study intersections and would not cause a noticeable change in transit travel time or vehicle delay for the bus routes in the study area.

Roadway

In accordance with State CEQA Guidelines Section 15064.3(b) and CEQA Statute Section 21099(b)(2), level of service (LOS) is not used as a CEQA impact criterion in this addendum but is still used for planning purposes and is relevant outside of the CEQA process to evaluate other non-CEQA transportation impacts of development projects, such as congestion, circulation, and safety issues and concerns. An intersection LOS and delay assessment was completed as a part of the *San Antonio Center Phase III Multimodal Transportation Analysis* (MTA; see Appendix D of this Addendum) prepared by Fehr and Peers; however, for the reason cited above, the results are not evaluated in this addendum for CEQA purposes, and policies related to LOS are not considered as part of the policy consistency evaluation. However, because the City of Mountain View (City) considers this information relevant for planning purposes, summary results are included in Appendix D for informational purposes.

The project would not interfere with existing or planned roadway facilities. Furthermore, as detailed in the MTA (Appendix D), it would not conflict with currently adopted goals or policies. Therefore, the project's impact on roadway facilities would be less than significant.

Bicycles

The project would not disrupt existing bicycle facilities. The existing bicycle lanes along California Street and San Antonio Road would be maintained. The project does not propose any new onsite or offsite bicycle pathways. Signs would be posted at the project driveways directing bicyclists to dismount and walk their bikes around the project site. The project would provide new Type I and Type II bicycle parking bicycle storage on site. In total, approximately 48 bicycle parking spaces would be provided on site, including 28 permanent bicycle lockers and 20 bicycle racks. Bicyclists would be able to access the permanent bicycle lockers and storage room via building access at the southeast corner at the intersection of San Antonio Road and California Street.

In the project vicinity, Silicon Way is a secondary bicycle facility, which is defined in the SAPP as including potential improvements to existing facilities and new bike facilities. These secondary facilities provide additional linkages to surrounding areas, including northern Mountain View and Palo Alto to the north, Rengstorff Park and Downtown Mountain View to the east, Downtown Los Altos to the south, and Palo Alto to the west. In addition, as detailed in the project's MTA, a Level of Traffic Stress (LTS) analysis was conducted as part of the City's comprehensive modal plan to measure the quality of a person's experience while bicycling through the city. Low-stress bikeways (LTS 1 and 2) are generally tolerated by most cyclists, while high-stress bikeways are only tolerated by strong and fearless cyclists. Under existing conditions, Shoreline Boulevard and California Street are LTS 3 but with future conditions, including the project, both roadways would improve to LTS 2. With the proposed bicycle facilities as part of the project in combination with future improvements planned under the SAPP, the LTS would be less stressful for most bicyclists in the Plan Area. Therefore, based on the discussion above, the project site can be considered a location accessible to both experienced and recreational cyclists and the project would not conflict with a program, plan, ordinance, or policy addressing bicycle facilities.

Pedestrians

The project would not disrupt existing pedestrian facilities. Pedestrian access to the project site is currently provided by sidewalks on all streets immediately adjacent to the project site. Most sidewalks are 5 to 12 feet wide, and many of them have a landscaping strip separating the sidewalk from the street. In addition, all major intersections near the project site have crosswalks. Primary pedestrian routes, as defined by the SAPP, include San Antonio Road and California Street. Primary pedestrian routes provide active building frontages with pedestrian-scaled features and align with open space and other important destinations. Silicon Way, to the east of the project site, is a secondary pedestrian route. Secondary pedestrian routes provide new interior connections with limited pedestrian improvements.

Under the proposed project, pedestrian pathways would be provided around the exterior of the proposed building to promote circulation between the various commercial uses. The proposed pedestrian paths through the project site would provide access to the frontages of California Street and San Antonio Road and to the adjacent San Antonio Village Phase II buildings to the south and east. Additionally, the pedestrian paths would provide connectivity to the sidewalks on San Antonio Road and California Street. In addition, within a 15-minute walk of the project site under existing conditions, pedestrians are only able to access up to El Camino Real, but with future walking conditions including the proposed project, pedestrians would have access to a greater area of the city including the Mountain View Community Center with 10 to 15 minutes of walking from the project site. Therefore, with the project, the aforementioned destinations and existing pedestrian facilities would remain accessible and the project would not conflict with a program, plan, ordinance, or policy addressing pedestrian facilities.

Conclusion

Overall, the proposed project's impacts associated with conflicts with a program, plan, ordinance, or policy addressing the circulation system, including transit, roadway, bicycle, and pedestrian facilities, would be less than significant. The proposed project would not result in new significant impacts or a substantial increase in the severity of impacts regarding conflicts with transportation programs, plans, ordinances, or policies, that were analyzed in the SAPP EIR.

b. Conflict or be inconsistent with CEQA Guidelines § 15064.3, subdivision (b)?

The transportation analysis that was prepared for the SAPP EIR followed the guidelines of the City and VTA, which acts as the Congestion Management Agency for Santa Clara County. Potential transportation impacts were evaluated using the standards, methods, and significance criteria of these agencies. In addition, mitigation measures for identified significant impacts were identified where such measures were available and feasible. Because the SAPP EIR was certified in 2014, before Senate Bill 743 was adopted, the transportation impact evaluation at that time included LOS and not vehicle miles traveled (VMT), as was required starting in 2020. The 2014 SAPP EIR included the San Antonio Village project. However, in June 2020, the Mountain View City Council endorsed an approach for conducting VMT analysis for development projects that require transportation analysis citywide, in combination with requirements for a local-level analysis of multimodal transportation impacts. The City's VMT Policy establishes screening criteria for developments that qualify as transit-supportive projects and are expected to result in a less-than-significant transportation impact under CEQA. Such projects are not required to prepare further VMT analyses. The City's screening criteria are consistent with the guidance provided in the California Governor's Office of Planning and Research's 2018 *Technical Advisory on Evaluating Transportation Impacts in CEQA* (OPR 2018).

The “proximity to transit” screening criterion applies to the proposed project. The City defines this consistently with State CEQA Guidelines Section 15064.3, subdivision (b)(1), which states that lead agencies should presume that certain projects within 0.5 mile of an existing major transit stop or an existing stop along a high-quality transit corridor will have a less-than-significant impact on VMT.

The project site is within a 0.5-mile walk of rail and transit stops. The San Antonio Caltrain and Transit Station are approximately 0.25 mile north of the project site. The Transit Center, which includes a Caltrain Station and VTA bus service, is considered a major transit stop. More detailed analysis of VMT is recommended for projects that are within 0.5 mile of an existing major transit stop but meet certain exceptions. These exceptions include projects with a floor area ratio (FAR) of less than 0.75, projects that provide more than the maximum parking required by the City, projects that are inconsistent with the sustainable communities strategy (*Plan Bay Area*), or projects that replace affordable residential units with a smaller number of moderate- or high-income residential units. The project would have a FAR of 4.22 with the transfer of development rights program with Los Altos School District, and a FAR of 0.75 without the transfer of development rights. The project would provide fewer parking spaces than required by the City Zoning Code. The project is consistent with *Plan Bay Area* (MTC and ABAG 2017) because it would provide transit-oriented jobs by constructing a mixed-use commercial/office building in a transit-rich area as opposed to an auto-centric area, in addition to providing bicycle, carshare, and shuttle service facilities on site. The project would also implement transportation demand management programs to promote alternative modes of transportation and reduce vehicle trips and greenhouse gas emissions. Therefore, the project qualifies as a transit supportive project and is consistent with Section 15064.3(b). Furthermore, the intersection operational analysis determined that the project would not cause the study intersections (listed on page 5 of the MTA; see Appendix D) to operate below their respective operational thresholds. In addition, based on the location of the project and the trip generation, distribution, and assignment, the project would not contribute more than 1 percent of the freeway mixed-flow or high-occupancy vehicle lanes’ capacity and a freeway analysis is not required. The proposed project is consistent with the findings in the SAPP EIR. Therefore, the proposed project’s impacts associated with inconsistency with State CEQA Guidelines 15064.3(b) would be less than significant. The proposed project would not result in new significant impacts or a substantial increase in the severity of impacts regarding inconsistency with State CEQA Guidelines 15064.3(b) that were analyzed in the SAPP EIR.

c. *Substantially increase hazards due to a geometric design feature (e.g., sharp curves or dangerous intersections) or incompatible uses (e.g., farm equipment)?*

The SAPP EIR found that impacts related to increased hazards due to a geometric design feature or incompatible uses would be less than significant.

Construction of the project would temporarily introduce construction equipment and vehicles to the project site and nearby street network. However, the project would be required to follow Standard Condition of Approval PW-135, *Miscellaneous—Construction Management Plans*, which requires the submission of a construction traffic and parking management plan that establishes truck routes. PW-111 also ensures that sidewalks would remain accessible during construction. In addition, the project would be required to follow Standard Condition of Approval PW-36, *Traffic Control Plans*, which requires preparation of traffic control plans for any improvements that require lane, shoulder, bicycle land, and/or sidewalk closures. Adherence to these Standard Conditions of Approval would minimize potential traffic hazards during construction.

The project would not alter existing intersection lane configurations. Vehicular access to the project site would be provided from San Antonio Road and California Street, similar to under existing conditions. The project would include one entrance and one exit for the subterranean parking garage through the adjacent underground parking garage completed as part of the Phase II Village at San Antonio Center Project. Access to the joint underground garage is off San Antonio Road and under Silicon Way. Driveways that provide access to and from the project site would be required to adhere to Standard Conditions of Approval PW-44, *Corner Street Sight Triangle*, and PW-45, *Driveway [or Side Street] Sight Triangle*, which require vertical clearance at driveway locations to reduce hazards. Therefore, the proposed project's impacts associated with hazards due to a project design feature would be **less than significant**. The proposed project would not result in new significant impacts or a substantial increase in the severity of impacts regarding hazards due to a project design feature that were analyzed in the SAPP EIR.

d. Result in inadequate emergency access?

The SAPP EIR found that impacts related to inadequate emergency access would be less than significant.

Emergency access to the project site would be provided from one location on California Street and one location on San Antonio Road (see Figure 2-5 in Chapter 2, *Project Description*, which shows the proposed access points). In addition, the internal streets of Silicon Way and Promenade Lane would provide full emergency access around the project site, as Silicon Way is approximately 22 feet wide and Promenade Lane is approximately 26 feet wide. Furthermore, the project design would be required to adhere to all applicable emergency access requirements and standards. These emergency access points would provide adequate access for emergency vehicles. Therefore, the proposed project's impacts associated with emergency access would be **less than significant**. The proposed project would not result in new significant impacts or a substantial increase in the severity of impacts regarding emergency access that were analyzed in the SAPP EIR.

Applicable SAPP EIR Mitigation Measures and City Standard Conditions of Approval

SAPP EIR Mitigation Measures

The full text for the SAPP EIR mitigation measures applicable to the proposed project are identified below.

Mitigation Measure TRANS-1

Add a right turn overlap phase at Intersection #17, San Antonio Road/California Avenue for the westbound right turn movement, or comparable improvement to maintain acceptable intersection LOS. (LTS).

Conditions of Approval

The full text of the City's standard Conditions of Approval applicable to the proposed project are identified below.

COA PW-36 Traffic Control Plans

Upon submittal of the initial building permit and improvement plans, the applicant shall submit traffic control plans for any off-site and on-site improvements or any work that requires temporary lane closure, shoulder closure, bike lane closure, and/or sidewalk closure for review and approval. Sidewalk closures are not allowed unless reconstruction of sidewalk necessitates temporary sidewalk closure. In these instances, sidewalk detour should be shown on the Traffic Control plans. Traffic control plans shall be prepared in accordance with the latest edition of the California Manual of Uniform Traffic Control Devices (CA MUTCD).

COA PW-44 Corner Street Sight Triangle

At street corners of controlled and/or uncontrolled intersections, signs, fences, shrubs, bushes or hedges shall not exceed over 3' in height while tree canopies shall maintain a minimum 6' vertical clearance within traffic safety sight triangle formed by measuring 35' along the front and side property lines.

COA PW-45 Driveway [or Side Street] Sight Triangle

Within the pedestrian and/or vehicle traffic safety sight triangle(s), signs, fences, shrubs, bushes or hedges shall not exceed 3' in height while tree canopies shall maintain a minimum 6' vertical clearance at the driveway location.

COA PW-135 Construction Management Plans

Upon submittal of the initial building permit and all subsequent building permit submittals, the applicant shall provide a construction traffic and parking management plan with the building plans showing the following:

1. Truck Route: Truck route (to and from project site) for construction and delivery trucks pursuant to City Code Sections 19.58 and 19.59 and which does not include neighborhood residential streets; [OPTIONAL: The use of _____ [enter STREET NAME] shall be minimized];
2. Construction Phasing, Equipment, Storage, and Parking: Show construction vehicles and equipment parking area, material storage and lay-down area, and construction trailer location for each phase of construction. All construction vehicles/equipment and trailer shall be located on-site or at a site nearby (not on a public street or public parking) arranged by the permittee/contractor. Construction equipment, materials, or vehicles shall not be stored or parked on public streets or public parking lots. Construction contractors/workers are required to park on-site or at a private property arranged by the permittee/contractor and shall not be allowed to use neighboring streets for parking/storage; and
3. Sidewalk closure or narrowing is not allowed during any on-site construction activities.

The construction traffic and parking management plan must be approved prior to the issuance of a demolition permit.

	Did the Program EIR Identify a Significant Impact and Mitigation Measures?	Do Program EIR Mitigation Measures Apply to the Project?	Does New Information of Substantial Importance Require Preparation of a Supplemental Subsequent EIR?	Is There No New Information of Importance Requiring Preparation of a Supplemental/ Subsequent EIR?
XIV. Utilities and Service Systems				
Would the project:				
a. Require or result in the relocation or construction of new or expanded water, wastewater treatment or storm water drainage, electric power, natural gas, or telecommunications facilities, the construction or relocation of which could cause significant environmental effects?	<input checked="" type="checkbox"/>	<input type="checkbox"/>	<input type="checkbox"/>	<input checked="" type="checkbox"/>
b. Have sufficient water supplies available to serve the project and reasonably foreseeable future development during normal, dry and multiple dry years?	<input checked="" type="checkbox"/>	<input checked="" type="checkbox"/>	<input type="checkbox"/>	<input checked="" type="checkbox"/>
c. Result in a determination by the waste water treatment provider, which serves or may serve the project, that it has adequate capacity to serve the project's projected demand in addition to the provider's existing commitments?	<input checked="" type="checkbox"/>	<input checked="" type="checkbox"/>	<input type="checkbox"/>	<input checked="" type="checkbox"/>
d. Generate solid waste in excess of state or local standards, or in excess of the capacity of local infrastructure, or otherwise impair the attainment of solid waste reduction goals?	<input type="checkbox"/>	<input type="checkbox"/>	<input type="checkbox"/>	<input checked="" type="checkbox"/>
e. Comply with federal, state, and local management and reduction statutes and regulations related to solid waste?	<input type="checkbox"/>	<input type="checkbox"/>	<input type="checkbox"/>	<input checked="" type="checkbox"/>
f. Result in potentially significant environmental impact due to wasteful, inefficient, or unnecessary consumption of energy resources, during project construction or operation?	<input type="checkbox"/>	<input type="checkbox"/>	<input type="checkbox"/>	<input checked="" type="checkbox"/>
g. Conflict with or obstruct a state or local plan for renewable energy or energy efficiency?	<input type="checkbox"/>	<input type="checkbox"/>	<input type="checkbox"/>	<input checked="" type="checkbox"/>

Note: A checked box indicates a “yes” answer.

3.13 Utilities and Service Systems

a. Require or result in the relocation or construction of new or expanded water, wastewater treatment or storm water drainage, electric power, natural gas, or telecommunications facilities, the construction or relocation of which could cause significant environmental effects?

The SAPP EIR found that impacts related to the relocation or construction of new or expanded water, wastewater treatment or storm water drainage, electric power, natural gas, or telecommunications facilities would be less than significant with implementation of Mitigation Measures UTL-1, UTL-2, and UTL-3.

Existing water, stormwater, sanitary sewer system, natural gas, electricity, and telecommunications facilities (i.e., lines) would continue to serve the project site. New onsite facilities would be connected to new services through the installation of new, localized connections. Expansions or an

increase in capacity of offsite infrastructure would occur as required by the utility providers. Based on the proposed project onsite utility infrastructure described below, implementation of the project would result in construction of the following utility facilities.

- **Potable Water:** Two 2-inch domestic water connections are proposed to connect to an existing 10-inch main in California Street. One of these connections would be connected in the future to recycled water mains once extended into the project area. In addition, an 8-inch fire service would be connected to the 10-inch main in California Street. Furthermore, an existing 1.5-inch domestic water meter from San Antonio Road may be converted to an irrigation service or new 1.5-inch irrigation service as part of the proposed project. The irrigation service line would be converted to recycled water when it becomes available to the project site and surrounding area.
- **Stormwater:** The proposed project would install two 8-inch storm drains that would also connect to an existing 30-inch storm main in California Street. High-capacity bio-filtration best management practices would be used on the project site to treat stormwater. In addition, planter boxes and a low-impact development (LID)-based treatment system would be used to treat stormwater runoff from the roof of the proposed building. Furthermore, proprietary biofiltration units and non-LID treatment systems would be used to treat ground-level stormwater runoff.
- **Sanitary Sewer System:** The proposed project would include a 6-inch sanitary sewer connection to an existing 8-inch main in California Street. All other existing wastewater utility infrastructure would remain.
- **Dry utilities (Electricity, Natural Gas, and Telecommunications):** The project proposes to construct new dry utility service connections. A 3-inch gas connection would be provided from San Antonio Road. All electrical and telecommunication utilities would be connected to existing electrical and telecommunication utilities in California Street.

As described in more detail in the impact discussions below, the proposed project would add flow to the existing sewer system's infrastructure deficiencies but would not increase the number of deficient pipes. In order to adequately accommodate wastewater flow from the proposed project, it is recommended that several pipes in the West Yost Capital Improvement Program (CIP) are upsized from 10-inch- and 12-inch-diameter sewer pipes to 15-inch-diameter sewer pipes. Furthermore, there are several deficient pipes within the existing stormwater system downstream of the project site. However, the project would not result in additional deficiencies because the post-project peak flow would be only 3 percent higher than pre-project peak flow. To address the existing system deficiencies, the 2019 Storm Drain Master Plan recommends one CIP between San Antonio Road and Adobe Creek.¹ The CIP upsizes a 6.5-foot-diameter storm drain pipe to an 8-foot-diameter storm drain pipe to alleviate flooding during the 10-year flooding event when Adobe Creek levels are high.

The installation or expansion of the aforementioned utility improvements would require excavation, trenching, soil movement, and other activities that are typical of development projects in the Plan Area and Mountain View, as discussed in detail in this document as part of the assessment of overall project impacts. Project-specific impacts related to the construction or expansion of utilities as a component of the proposed project are discussed in Section 3.1, *Air*

¹ Schaaf & Wheeler. 2019. *City of Mountain View Storm Drain Master Plan*.

Quality (i.e., fugitive dust and criteria air pollutants), Section 3.10, *Noise* (i.e., ambient noise levels), and Section 3.9, *Transportation and Traffic* (i.e., transportation and circulation network). In summary, impacts related to the construction of new utility facilities for the proposed project are addressed as part of the analysis of construction impacts for the proposed project as a whole. The installation or expansion of any utility facilities for the project would not result in additional significant impacts that are not otherwise disclosed elsewhere in this document or the San Antonio Precise Plan (SAPP) EIR.

Based on the analysis above, the project would not require or result in the relocation or construction of new or expanded water, wastewater treatment or stormwater drainage, electric power, natural gas, or telecommunications facilities, the construction or relocation of which could cause significant environmental effects. Therefore, with SAPP EIR mitigation applied, similar to those impacts identified in the SAPP EIR, the proposed project's impacts associated with the relocation or construction of new utility facilities would be ***less than significant***. The proposed project would not result in new significant impacts or a substantial increase in the severity of impacts regarding the relocation or construction of new utility facilities that were analyzed in the SAPP EIR.

b. Have sufficient water supplies available to serve the project and reasonably foreseeable future development during normal, dry and multiple dry years?

The SAPP EIR found that impacts related to water supply would be less than significant with implementation of Mitigation Measure UTL-1.

The City municipal water system serves 98 percent of Mountain View, including the project site. The Mountain View water system is divided into three pressure zones. Pressure Zone 1 is north of the Central Expressway, continuing to San Francisco Bay; Pressure Zone 2 is between Cuesta Drive and the Central Expressway; and Pressure Zone 3 is south of Cuesta Drive. The project site is in Pressure Zone 2, which is supplied by two San Francisco Public Utilities Commission turnouts. This supply can be supplemented with water from City-operated groundwater wells. Water demand in Pressure Zone 2 can be sufficiently supplied by the turnouts; however, as discussed in the 2030 General Plan Update Utility Impact Study (GPUUIS), surplus supply in Pressure Zone 2 would need to be routed to Pressure Zone 1 to make up the supply deficiency in the lower zone. The remainder of Mountain View is served by the California Water Service Company. The City purchases water from both the Santa Clara Valley Water District and San Francisco Public Utilities Commission. In addition, water from four potable groundwater wells, which are owned and operated by the City, supplements these sources.

As stated in the SAPP EIR, according to the Water Supply Assessment prepared for the SAPP, it is expected that even without development in the Plan Area, the City would have to rely on implementation of its Water Shortage Contingency Plan during some dry years to reduce demands. However, given the small amount of future growth associated with implementation of the SAPP relative to that of the city by 2030, the City would not have to change its operations or the implementation of the Water Shortage Contingency Plan in response to a drought, even after development associated with the SAPP is completed. In addition, development within the Plan Area is required to include a number of sustainability features, such as low-flow appliances and drought-resistant landscaping, to further reduce water consumption and conserve water. Furthermore, consistent with the SAPP EIR Mitigation Measure UTL-1, the City requires project-specific capacity and conditions analyses of applicable water infrastructure adjacent and downstream of project sites.

As stated previously, water supply to the proposed project would be provided by two 2-inch domestic water connections to an existing 10-inch main in California Street. One of these connections would be connected in the future to recycled water mains once extended into the project area. In addition, an 8-inch fire service would be connected to the 10-inch main in California Street. Furthermore, an existing 1.5-inch domestic water meter from San Antonio Road may be converted to an irrigation service or new 1.5-inch irrigation service as part of the proposed project.

Water demand represents an established daily average water use pattern, which varies by season and by customer type. Existing (baseline) water demand at the project site totals approximately 1,300 gallons per day (gpd) and 1,934 gpd under future cumulative conditions. The pre-project (baseline) condition includes parcel-level demand, as adopted from the City's InfoWater model and calibrated against water billing records from 2005 and 2006. The proposed project is expected to have a projected water demand of 17,012 gpd. The proposed project would increase water demand on site by approximately 15,712 gpd under existing conditions and 21,772 gpd under future cumulative conditions. The projected water demand does not exceed the SAPP EIR demand allocations under existing and future cumulative conditions; therefore, it would not affect the City's ability to meet total system water demand.

In addition, fire services for the proposed project are projected to have a water demand of 1,750 gallons per minute (gpm) fire flow with an applied 50-percent reduction for the assumed approval of an automatic sprinkler system. It is likely that this is a conservative reduction estimate, as up to a 75-percent reduction is allowed upon approval of an automatic sprinkler system. The pre-project fire flow is set to 5,000 gpm based on parcel-specific fire flows identified in the 2010 Urban Water Management Plan.² This fire flow is not met at the existing hydrant location on California Street and San Antonio Road; however, the anticipated project-specific fire flow requirement of 1,750 gpm would be met, as these deficiencies are independent of the proposed project and show minimal (less than 1 percent) impact with project development. Several CIPs from the GPUUIS are in the vicinity of the project site and provide additional conveyance to the system, including CIP #31 on Miller Avenue and CIP #32 on California Street, which include upsizing 405 linear feet of a 10-inch-diameter pipe to a 12-inch-diameter pipe, and upsizing 365 linear feet of an 8-inch-diameter pipe to a 12-inch-diameter pipe, respectively.

The project-specific Utility Impact Study (Appendix E of this Addendum) concludes that the total projected water supplies available to the project site during baseline and future cumulative conditions are sufficient to meet the projected water demands for the project, in addition to existing uses. This demonstrates compliance with SAPP EIR Mitigation Measure UTL-1 requiring preparation of project-specific capacity and conditions analyses demonstrating available water supplies exist to support the proposed project. Therefore, with SAPP EIR Mitigation Measure UTL-1 applied, similar to those impacts identified in the SAPP EIR, the proposed project's impacts associated with water supply would be ***less than significant***. The proposed project would not result in new significant impacts or a substantial increase in the severity of impacts regarding water supply that were analyzed in the SAPP EIR.

² City of Mountain View. 2011. 2010 Urban Water Management Plan. Available: <https://www.mountainview.gov/civicax/filebank/blobload.aspx?blobid=8497>. Accessed: September 3, 2021.

c. Result in a determination by the waste water treatment provider, which serves or may serve the project, that it has adequate capacity to serve the project's projected demand in addition to the provider's existing commitments?

The SAPP EIR found that impacts related to wastewater services would be less than significant with implementation of Mitigation Measure UTL-2.

As explained in the SAPP EIR, the City entered into a joint agreement, referred to as the Basic Agreement, with the cities of Palo Alto and Los Altos in 1968 for the construction and maintenance of a joint sewer system, thereby addressing a need for the conveyance, treatment, and disposal of wastewater, in accord with Regional Water Quality Control Board requirements. Under the Basic Agreement, Palo Alto owns the Regional Water Quality Control Plant (RWQCP) and administers the Basic Agreement with the partnering agencies. It purchases individual capacity rights in terms of an average annual flow that can be discharged to the RWQCP. The City's total capacity rights include flow leaving the city through the Shoreline Pump Station and the amount of flow that the City discharges into the Los Altos San Antonio Interceptor, per the 1970 Los Altos San Antonio Trunk Sewer Capacity agreement between the two cities.

Sewage generated within the city and Plan Area is treated at the RWQCP in Palo Alto. The sewer collection system is a gravity system, with the majority of flow discharging into three main trunk lines that convey flow from the south to the north and terminate at the Shoreline Pump Station within the City's Shoreline Park. Flow is then pumped to the gravity Joint Interceptor Sewer that conveys flow to the RWQCP. The remaining flow not received at the Shoreline Pump Station is discharged to the Los Altos San Antonio Interceptor that also conveys flow into the Joint Interceptor. The sewer system that serves the project site continues along California Street, north along Pachetti Way, west at the intersection of Pachetti Way and Sondgroth Way toward San Antonio Road, north along San Antonio Road, and ultimately flows to the Alma Recorder. The project would discharge into the 8-inch public sewer main from a 6-inch sanitary sewer connection at the project site.

Because the project would involve infill development, the proposed project's impacts are evaluated by estimating the total sewer flow at the project site post-project and comparing it to the pre-project baseline sewer flow. Project-generated sewer flow was estimated using the square footage of the proposed building and is provided in Table 3.13-1 below.

Table 3.13-1. Baseline Sewer Flow for Existing Conditions and Project Conditions

Building	Acreage or Square Footage (sf)	Sewer Flow (gpd)
Existing Conditions		
2595 California Street	0.39	413
2595 California Street	0.24	534
365 San Antonio Road	0.3	36
405 San Antonio	0.06	256
<i>Total</i>		<i>1,239</i>
Project Conditions		
Retail uses	15,000 sf	1,600
General Commercial/Office Uses	167,352	11,715
<i>Total</i>		<i>13,215</i>
Total Net Change		+11,976

Source: Appendix E.

Wastewater Treatment Capacity

According to the SAPP EIR, the remaining capacity at the Palo Alto RWQCP is sufficient to serve potential new development and redevelopment in the city as anticipated under the SAPP, which includes the proposed project. Consistent with SAPP EIR Mitigation Measure UTL-2, the City requires project-specific capacity and conditions analysis of applicable wastewater infrastructure to identify any impacts on the wastewater system and, as a condition of approval, the Public Works Department will determine and assign responsibility to project applicants for any necessary upgrades or improvements to the infrastructure. Therefore, with SAPP EIR mitigation applied, similar to those impacts identified in the SAPP EIR, the proposed project's impacts associated with wastewater treatment capacity would be **less than significant**. The proposed project would not result in new significant impacts or a substantial increase in the severity of impacts regarding wastewater treatment capacity that were analyzed in the SAPP EIR.

System Infrastructure

The proposed project would include a 6-inch sanitary sewer connection to an existing 8-inch main in California Street. All other existing wastewater utility infrastructure would remain. As detailed in the project-specific Utility Impact Study prepared by Schaaf & Wheeler (Appendix E of this Addendum), the sewer system does not have sufficient capacity downstream of the project for pre-project or post-project flows in existing conditions or future cumulative conditions. There are deficient pipes downstream of the project site along Pachetti Way, Sondgroth Way, and San Antonio Circle, with several of the deficient pipes surcharging. The project would add flow to these deficient pipes, but would not increase the number of deficient pipes.

The project site is within the portion of the city referred to as the Alma Recorder Area that contributes flow to the Los Altos Inceptor Sewer and has a contractual limitation of 2 million gpd of peak wet-weather flow. In existing conditions, pre-project flow to the Alma Recorder during peak wet weather is 14 percent below the contractual limit and would be 13 percent below the contractual limit post-project. In the future cumulative condition, pre-project flow to the Alma Recorder during peak wet weather would be 8 percent below the contractual limit pre- and post-project.

The total system-wide contractual capacity for Mountain View at the RWQCP in Palo Alto is evaluated in the existing and future cumulative conditions with increased project flows. When their respective service area reaches 80 percent of their contractual capacity rights, partnering agencies will agree to conduct an engineering study. The future cumulative condition estimates that the projected demand pre-project and post-project would exceed the 80-percent capacity threshold. The required engineering study when the City reaches 80 percent of its capacity shall redefine the anticipated future needs of the treatment plant.

In the *Wastewater Capacity and Alignment Study El Camino Real & San Antonio Change Areas Project 14-48* (West Yost report) (West Yost 2017),³ the capacity of the sewer system within the Alma Recorder tributary area was evaluated and new infrastructure was recommended to divert flow from surcharged pipes along Sondgroth Way. The report identified several sewer mains along the project's flow path that should be upsized, including pipes along San Antonio Circle and crossing Central Expressway.

³ West Yost. 2017. *Wastewater Capacity and Alignment Study El Camino Real & San Antonio Change Areas Project 14-48*.

In future cumulative conditions, the sewer system would not have adequate capacity either pre- or post-project with the CIPs recommended in the West Yost report. It is assumed that CIP #32 under the GPUUIS would be constructed under future cumulative conditions. An additional pipe from CIP #32 of the GPUUIS has been recommended to be upsized to meet the City's flow requirements for pre-project conditions. In addition, it is recommended that the pipes in the West Yost CIPs are upsized from 10-inch- and 12-inch-diameter to 15-inch-diameter, as well as that an additional 8-inch-diameter pipe (Pipe ID 3737) be upsized to a 10-inch-diameter pipe to accommodate additional sewer flows.

Consistent with the SAPP EIR Mitigation Measure UTL-2, the City requires project-specific capacity and conditions analysis of applicable wastewater infrastructure to identify any impacts on the wastewater system and, as a condition of approval, the Public Works Department will determine and assign responsibility to project applicants for any necessary upgrades or improvements to the infrastructure. With incorporation of the recommended sewer upgrades identified above, the project would not result in new significant impacts. Therefore, with SAPP EIR mitigation applied, similar to those impacts identified in the SAPP EIR, the proposed project's impacts associated with wastewater treatment infrastructure would be *less than significant*. The proposed project would not result in new significant impacts or a substantial increase in the severity of impacts regarding wastewater treatment infrastructure that were analyzed in the SAPP EIR.

d. Generate solid waste in excess of state or local standards, or in excess of the capacity of local infrastructure, or otherwise impair the attainment of solid waste reduction goals?

The SAPP EIR found that impacts related to solid waste capacity would be less than significant.

Recology Mountain View (formerly known as Foothill Disposal) provides solid waste collection and recycling services for residents and businesses in Mountain View. Once collected, solid waste and recyclables are transported to the Sunnyvale Materials Recovery and Transfer station for sorting. Small quantities of waste may be transported to other landfills in the area by private contractors. Nonrecyclable waste from the Sunnyvale Materials Recovery and Transfer station is transported to the Kirby Canyon Landfill in San Jose. The Kirby Canyon Landfill has a permitted capacity of 36.4 million cubic yards, a remaining capacity of approximately 16.2 million cubic yards, and an anticipated closing date of December 31, 2059. The landfill receives a maximum of 2,600 tons of garbage per day (CalRecycle 2019). The estimated capacity accounts for all planned development through 2030.

As concluded in the SAPP EIR, new development and associated population and employment growth under buildout of the SAPP would increase demand for solid waste collection and disposal capacity. A total of approximately 1,500 office employees would work at the project site upon completion and occupancy of the new building. Per the SAPP EIR, employees dispose of approximately 4.9 pounds of solid waste per person per day. Using this generation rate, the project would result in an increase of approximately 7,350 pounds per day of solid waste, or 1,341 tons per year.⁴ The project would result in a negligible increase in solid waste per day at the existing Kirby Canyon Landfill, which has a remaining estimated capacity of approximately 16.2 million cubic yards. These solid waste generation factors are estimates prior to recycling, composting, or other waste-diversion programs.

⁴ Assuming 1,500 net new employees and 4.9 pounds of waste per person per day (1,500 x 4.9 pounds/day = 7,350 pounds/day). Assuming 1 pound = 0.0005 ton (7,291 pounds/day x 365 days/year x 0.0005 ton = 1,341 tons/year).

Actual disposal rates could be lower because the project would ensure that sufficient solid waste facilities are available for use in compliance with Standard Condition of Approval PL-03 (Findings of Approval) and with the Village at San Antonio Center's Trash Management Plan.⁵ Given the relatively high recycling rate of Mountain View and the Zero-Waste Plan goals, the project would not lead to a substantial burden on the existing Kirby Canyon Landfill.⁶ As described above, remaining capacity estimates at the Kirby Canyon Landfill account for all planned development, including the project. Accordingly, the proposed project would not generate solid waste in excess of state or local standards or in excess of the capacity of local infrastructure, or otherwise impair attainment of solid waste reduction goals. Therefore, the proposed project's impacts associated with solid waste generation would be **less than significant**. The proposed project would not result in new significant impacts or a substantial increase in the severity of impacts regarding solid waste generation that were analyzed in the SAPP EIR.

e. Comply with federal, state, and local management and reduction statutes and regulations related to solid waste?

The SAPP EIR found that impacts related to compliance with solid waste regulations would be less than significant.

All collection, transport, and disposal of solid waste generated by the proposed project would comply with all applicable federal, state, and local statutes. The project would be required to comply with the City's Construction and Demolition Ordinance, as required by Standard Condition of Approval PW-128 (Construction and Demolition Ordinance), and project construction would be required to comply with all applicable regulatory requirements related to solid waste.

Assembly Bill (AB) 341 requires commercial establishments to recycle. This law was extended by AB 1826 to require organics diversion for generators of organic waste (i.e., restaurants). State law also requires equal access to waste and recycling disposal locations. AB 1826 requires businesses and mixed-use residential developments that generate more than 4 cubic yards of solid waste per week to incorporate organic recycling programs, such as composting. To comply with City ordinances, AB 1826, and the Village at San Antonio Center's Trash Management Plan, the project's trash would be collected in four different streams: Waste, Dry Recyclables, Cardboard, and Compost.

Although up to approximately 7,350 pounds of solid waste per day would be generated, it is anticipated that some of that solid waste would be redirected in compliance with AB 1826. Actual disposal rates could be lower because the project would be required to ensure that sufficient solid waste facilities are available for use, in compliance with Standard Condition of Approval PL-03 (Findings of Approval). Operation of the project would be required to comply with federal, state, and local management and reduction statutes and regulations related to solid waste. Therefore, the proposed project's impacts associated with compliance with solid waste regulations would be **less than significant**. The proposed project would not result in new significant impacts or a substantial increase in the severity of impacts regarding compliance with solid waste regulations that were analyzed in the SAPP EIR.

⁵ American Trash Management. 2016. Merlone Geier, The Village at San Antonio Center—Mountain View, CA, Final Trash Management Plan. July 2016.

⁶ City of Mountain View. 2019. City of Mountain View Zero Waste Plan. Available: <https://www.mountainview.gov/civicax/filebank/blobdownload.aspx?BlobID=30681>. Accessed: September 3, 2021.

f. *Would the project result in potentially significant environmental impact due to wasteful, inefficient, or unnecessary consumption of energy resources, during project construction or operation?*

Impacts to energy were discussed and analyzed in both the greenhouse gas (GHG) emissions and utilities and service systems sections of the SAPP EIR. The SAPP EIR found that impacts related to energy would be less than significant.

Construction

Construction of the project would include activities such as demolition, excavation, and foundation and building construction, which would require the use of trucks and other types of heavy equipment that would consume energy resources. Energy resources consumed during construction of the project primarily would result from the use of construction equipment (e.g., excavators). Construction activities for the project would result in a temporary increase in demand for energy. However, the energy consumed during project construction would be considered a small, temporary increase in energy demand because construction activities would occur over an approximately 28-month period; therefore, energy consumption is considered short-term. Therefore, the proposed project's impacts associated with the wasteful, inefficient, or unnecessary consumption of energy resources during project construction would be ***less than significant***. The proposed project would not result in new significant impacts or a substantial increase in the severity of impacts regarding energy consumption during project construction that was analyzed in the SAPP EIR.

Operation

The project design would incorporate numerous energy-efficiency features, including electric vehicle parking spaces and drought-tolerant landscaping. The project applicant intends to pursue Leadership in Energy and Environmental Design (LEED) Gold certification for the project and could incorporate features such as low-flow plumbing fixtures, Energy Star appliances, light-emitting diode (LED) technology, low-flow irrigation systems, bio-filtration planters, a highly efficient building envelope to mitigate solar heat gain, or below-grade parking to reduce the heat island effect.⁷ In addition, the project would incorporate Transportation Demand Management (TDM) measures, such as secure bicycle parking and subsidizing transit, carshare, walking and biking costs, which would reduce energy consumption in the form of diesel and gasoline from mobile vehicles. Therefore, the proposed project's impacts associated with the wasteful, inefficient, or unnecessary consumption of energy resources during project operation would be ***less than significant***. The proposed project would not result in new significant impacts or a substantial increase in the severity of impacts regarding energy consumption during project operation that was analyzed in the SAPP EIR.

g. *Would the project conflict with or obstruct a state or local plan for renewable energy or energy efficiency?*

Although the SAPP EIR did not have a separate analysis for energy and energy resources specifically, impacts to energy resources were discussed and analyzed in both the GHG emissions and utilities and service systems sections of the SAPP initial study and EIR, respectively. The SAPP EIR found that impacts related to conflicts with renewable energy or energy efficiency plans or measures would be less than significant.

⁷ According to the U.S. EPA, heat islands are urbanized areas that experience higher temperatures than outlying areas. Urban areas where structures, such as roads or buildings, are concentrated and landscaping or open space is limited, become islands of higher temperatures (between 1-7°F higher in the daytime, and 2-5°F higher during the nighttime), relative to surrounding areas (see: <https://www.epa.gov/heatislands>).

With incorporation of the previously mentioned energy-efficient and sustainable-design features, as well as the TDM measures, the project would be consistent with the City's Green Building Code and the California Green Building Standards Code, as well as with measures outlined in the City's Greenhouse Gas Reduction Program. The project would not conflict with or obstruct any state or local plans pertaining to energy efficiency. Therefore, the proposed project would have **no impact** associated with conflicts with applicable state or local renewable energy, or energy efficiency plans. The proposed project would not result in new significant impacts or a substantial increase in the severity of impacts regarding conflicts with renewable energy or energy efficiency plans that were analyzed in the SAPP EIR.

Applicable SAPP EIR Mitigation Measures and City Standard Conditions of Approval

SAPP EIR Mitigation Measures

The full text for SAPP EIR mitigation measures associated with the proposed project are identified below.

Mitigation Measure UTL-1

As private properties within the Plan area are developed, project-specific capacity and condition analyses of applicable water infrastructure adjacent and downstream of the project sites shall be performed to identify any impacts to the water system. As a condition of approval and prior to issuance of grading and/or building permits, the Public Works Department will determine and assign responsibility to project applicants for upgrades and improvements to the City's water infrastructure, as necessary.

Mitigation Measure UTL-2

As private properties within the Plan area are developed, project-specific capacity and condition analyses of applicable wastewater infrastructure adjacent and downstream of the project sites shall be performed to identify any impacts to the wastewater system. As a condition of approval and prior to issuance of grading and/or building permits, the Public Works Department will determine and assign responsibility to project applicants for upgrades and improvements to the City's wastewater infrastructure, as necessary.

Mitigation Measure UTL-3

As private properties within the Plan area are developed, project-specific analyses of stormwater infrastructure adjacent and downstream of the project sites shall be performed to identify any impacts to the system. As a condition of approval and prior to issuance of grading and/or building permits, the Public Works Department will determine and assign responsibility to project applicants for upgrades and improvements to the City's stormwater infrastructure, as necessary.

Conditions of Approval

The full text of the City's standard Conditions of Approval applicable to the proposed project are identified below.

COA PW-128 Mountain View Green Building Code/Construction and Demolition Ordinance

If this project is subject to the requirements of the Mountain View Green Building Code, a Construction and Demolition Waste Management Plan shall be submitted with the building permit application and approved by the Solid Waste and Recycling Section prior to issuance of a building permit. A Final Construction and Demolition Waste Management Plan shall be submitted and approved prior to final inspection.

The California Environmental Quality Act Lead Agency is the City of Mountain View. ICF prepared this environmental impact report on the Lead Agency’s behalf. Additional technical assistance was provided by Fehr & Peers for the transportation analysis prepared for the project and by Schaaf & Wheeler for the utility impact study prepared for the project. This chapter lists the individuals who prepared the reports.

4.1 City of Mountain View, Community Development Department (Lead Agency)

Zoning Administrator/Planning Manager	Stephanie Williams
Senior Planner	Clarissa Burke

4.2 ICF (Consultant)

4.2.1 Project Management

Project Director	Shilpa Trisal
Project Manager	Jessica Viramontes
Deputy Project Manager	Devan Atteberry
Project Coordinator	Zachary Cornejo

4.2.2 Technical Analyses

Air Quality	Cory Matsui
Biological Resources	Devan Atteberry
Cultural Resources and Tribal Cultural Resources	Gretchen Boyce, Lily Arias, Eleanor Cox, Jennifer Wildt, and Tait Elder
Energy	Devan Atteberry
Geology and Soils	Diana Roberts
Greenhouse Gas Emissions	Austin Kerr and Cory Matsui
Hazards and Hazardous Materials	Mario Barrera
Hydrology and Water Quality	Katrina Sukola
Land Use and Planning	Devan Atteberry
Noise	Elizabeth Foley
Population and Housing	Devan Atteberry
Public Services and Recreation	Devan Atteberry
Transportation and Circulation	Devan Atteberry

Utilities and Service Systems
Editing and Document Production

Devan Atteberry
John Mathias, Tamar Grande, Saadia Byram, and
Anthony Ha

Graphics
GIS

Alan Barnard
Jesika Allen

4.3 Schaaf & Wheeler (Consultant)

Vice President
Senior Engineer

Leif Coponen
Fidel Salamanca

4.4 Fehr & Peers (Consultant)

Principal
Senior Transportation Engineer
Associate Transportation Engineer

Robert H. Eckols
Ryan Caldera
Robert Brown

Chapter 2, Project Description

None

Chapter 3

Metropolitan Transportation Commission. 2017. *Open Data Catalog, Transit Priority Areas*. Available: <https://opendata.mtc.ca.gov/datasets/MTC::transit-priority-areas-2021-1/about>. Accessed: April 28, 2021.

Aesthetics

None

Biological Resources

Santa Clara Valley Habitat Agency. 2021. *Habitat Agency Geobrowser*. Available: <http://www.hcpmaps.com/habitat/>. Accessed: May 14, 2021.

Cultural and Tribal Cultural Resources

Chang, C. 2015. *DPR Record P-43-000021*. On file at the Northwest Information Center, Rohnert Park, CA.

Loud. 1912.

Martinez J., and S. Moore. 2010. *DPR Record P-43-000042*. On file at the Northwest Information Center, Rohnert Park, CA.

Much, B. 2015. *DPR Record P-43-000595*. On file at the Northwest Information Center, Rohnert Park, CA.

Nelson. 1910.

Energy

None

Geology and Soils

Maguire, K. C., and P. A. Holroyd. 2016. Pleistocene Vertebrates of Silicon Valley (Santa Clara County, California). *PaleoBios* 33(0). Available: <https://escholarship.org/content/qt3k43832x/qt3k43832x.pdf>. Accessed: June 25, 2021.

Wagner, D. L., E. J. Bortugno, and R. D. McJunkin. 1991. *Geologic Map of the San Francisco–San Jose Quadrangle, California, 1:250,000*. Available: https://www.conservation.ca.gov/cgs/Documents/Publications/Regional-Geologic-Maps/RGM_005A/RGM_005A_SanFrancisco-SanJose_1991_Sheet1of5.pdf. Accessed: June 25, 2021.

Greenhouse Gas Emissions

City of Mountain View. 2012. *Mountain View Greenhouse Gas Reduction Program*. August. Available: <https://www.mountainview.gov/civicax/filebank/blobdload.aspx?blobid=10700>. Accessed: April 22, 2021.

City of Mountain View. 2014. *San Antonio Precise Plan Final Environmental Impact Report*. December. Accessed: April 22, 2021.

Hazards and Hazardous Materials

Roux Associates, Inc. 2020. *Phase I Environmental Site Assessment 365 San Antonio Road, and 2585 and 2595 California Street Mountain View, California*. Final. 2904.0011S100/R. Mountain View, CA. Oakland, CA: Prepared by Roux Associates, Inc.

Hydrology and Water Quality

Federal Emergency Management Agency. 2020. *Flood Insurance Rate Map #06085C0038H*. Available: <https://msc.fema.gov/portal/search?AddressQuery=365%20San%20Antonio%20Road%2C%20Mountain%20View%20CA#searchresultsanchor>. Accessed: May 12, 2021.

Regional Water Quality Control Board. 2017. *San Francisco Bay Basin Water Quality Control Plan*. Available: https://www.waterboards.ca.gov/sanfranciscobay/water_issues/programs/planningtmdls/basinplan/web/docs/ADA_compliant/BP_all_chapters.pdf. Accessed: May 14, 2021.

Land Use and Planning

None

Noise

California Department of Transportation. 2013. *Technical Noise Supplement to the Traffic Noise Analysis Protocol*. September. Available: <https://dot.ca.gov/-/media/dot-media/programs/environmental-analysis/documents/env/tens-sep2013-a11y.pdf>. Accessed: September 2, 2020.

———. 2020. *Transportation and Construction Vibration Guidance Manual*. April. Available: <https://dot.ca.gov/-/media/dot-media/programs/environmental-analysis/documents/env/tcvgm-apr2020-a11y.pdf>. Accessed: May 20, 2020.

Cummins, Inc. 2015. *Specification Sheet: Diesel Generator Set QSX15 Series Engine*. Available: https://powersuite.cummins.com/sites/default/files/genset_specsheet_public/s-1582.pdf. Accessed: July 14, 2021.

Federal Transit Administration. 2006.

———. 2018. *Transit Noise and Vibration Impact Assessment*. Washington, D.C. September. Available: https://www.transit.dot.gov/sites/fta.dot.gov/files/docs/research-innovation/118131/transit-noise-and-vibration-impact-assessment-manual-fta-report-no-0123_0.pdf. Accessed: July 16, 2021.

Hoover & Keith, Inc. 2000. *Noise Control for Buildings and Manufacturing Plants*. Houston,

Federal Highway Administration. 2006. *FHWA Roadway Construction Noise Model User's Guide*. FHWA-HEP-05-054. January. Available: https://www.fhwa.dot.gov/ENVIRONMENT/noise/construction_noise/rcnm/rcnm.pdf. Accessed: May 18, 2021.

———. 2018. *Transit Noise and Vibration Impact Assessment Manual*. Washington, D.C. September. Available: https://www.transit.dot.gov/sites/fta.dot.gov/files/docs/research-innovation/118131/transit-noise-and-vibration-impact-assessment-manual-fta-report-no-0123_0.pdf. Accessed: July 16, 2021. Pages 110–113.

———. 2019.

Hoover & Keith, Inc. 2000. *Noise Control for Buildings and Manufacturing Plants*. Houston, TX.

Santa Clara County. 2016a. *Moffett Federal Airfield Comprehensive Land Use Plan*. Amended November 18, 2016. Available: https://www.sccgov.org/sites/dpd/DocsForms/Documents/ALUC_NUQ_CLUP.pdf. Accessed: July 13, 2021.

Santa Clara County. 2016b. *Palo Alto Airport Comprehensive Land Use Plan*. Amended November 16, 2016. Available: https://www.sccgov.org/sites/dpd/DocsForms/Documents/ALUC_PAO_CLUP.pdf. Accessed: July 13, 2021.

Population and Housing

U.S. Census Bureau. 2020a. *American Community Survey 1-year Estimates, Subject Tables, S0804—Means of Transportation to Work by Selected Characteristics for Workplace Geography, Mountain View*. Available: <https://data.census.gov/cedsci/table?q=S0804&g=1600000US0649670&tid=ACSST1Y2019.S0804&hidePreview=true>. Accessed: April 28, 2021; and

———. 2020b. *American Community Survey 1-year Estimates, Subject Tables, DP03—Selected Economic Characteristics, Mountain View*. Available: <https://data.census.gov/cedsci/table?q=DP03&g=1600000US0649670&d=ACS%201-Year%20Estimates%20Data%20Profiles&tid=ACSDP1Y2019.DP03&hidePreview=true>. Accessed: April 28, 2021.

Public Services and Recreation

Education Data Partnership. 2021a. *Mountain View-Los Altos Union High*. Available: <http://www.ed-data.org/district/Santa-Clara/Mountain-View--Los-Altos-Union-High>. Accessed: June 17, 2021.

———. 2021b. *Los Altos Elementary*. Available: <http://www.ed-data.org/district/Santa-Clara/Los-Altos-Elementary>. Accessed: June 17, 2021.

Los Altos School District. 2020. *Los Altos School District Master Plan 2020*. Available: <https://agendaonline.net/public/Meeting/Attachments/DisplayAttachment.aspx?AttachmentID=1117817&IsArchive=0>. Accessed: June 17, 2021.

Mountain View Police Department. 2020. *Mountain View Police Department Annual Report 2019*. Available: <https://www.mountainview.gov/civicax/filebank/blobdload.aspx?BlobID=33177>.

Transportation and Traffic

City of Mountain View. 2015. *Mountain View Bicycle Transportation Plan Update*. Adopted November 17, 2015. Available: <https://www.mountainview.gov/civicax/filebank/blobdload.aspx?BlobID=18294>. Accessed: August 13, 2021.

Governor's Office of Planning and Research. 2018. *Technical Advisory on Evaluating Transportation Impacts in CEQA*. December. Available: http://opr.ca.gov/docs/20190122-743_Technical_Advisory.pdf.

Metropolitan Transportation Commission and Association of Bay Area Governments. 2017. *Plan Bay Area 2040*. Adopted July 26, 2017. Available: <http://files.mtc.ca.gov/library/pub/30060.pdf>.

Utilities and Service Systems

California Department of Resources Recycling and Recovery. 2019. *SWIS Facility/Site Activity Details*. Available: <https://www2.calrecycle.ca.gov/SolidWaste/SiteActivity/Details/1370?siteID=3393>. Accessed: June 21, 2021.

Appendix A
Air Quality Supporting Materials

Appendix 3.1. Methods for Analysis – Health Risk Assessment

Diesel Particulate Matter Analysis

Diesel-powered construction equipment would emit DPM that could expose nearby sensitive receptors to increased cancer and non-cancer risks. Given that the proposed project would introduce DPM emissions to an area near existing sensitive receptors, a human HRA was performed using EPA's most recent dispersion model, AERMOD (version 21112); chronic risk assessment values presented by OEHHA; and other assumptions for model inputs from BAAQMD's *Air Toxics NSR Program Health Risk Assessment Guidelines*.¹ The HRA takes into account OEHHA's most recent guidance and calculation methods from the *Air Toxics Hot Spots Program Guidance Manual for the Preparation of Risk Assessments*.²

The HRA analyzes health risks to nearby sensitive receptors from construction activities. The human HRA consists of three parts: a DPM inventory, air dispersion modeling, and risk calculations. A description of each of these parts follows.

DPM Inventory

The DPM inventory includes mitigated emissions associated with short-term construction activity. The construction DPM inventory was assumed to be equal to the CalEEMod output results for diesel PM_{2.5} exhaust. The construction PM_{2.5} inventory was assumed to be equal to the CalEEMod output results for the sum of PM_{2.5} exhaust and fugitive dust. To quantify the project's emissions in CalEEMod, the following methods were used.

Land uses that could be developed under the proposed project would generate construction-related emissions from mobile and stationary construction equipment exhaust, employee and haul truck vehicle exhaust, land clearing and material movement, paving, and application of architectural coatings. Criteria pollutant emissions were estimated using the California Emissions Estimator Model (CalEEMod) (version 2020.4.0). Construction schedule, material quantities, equipment operating details, and truck trip quantities were provided by the project applicant. These data were used to estimate construction emissions. Emissions from gasoline light duty vehicles (e.g., construction workers) were adjusted to account for the impact of the implementation of the SAFE Vehicles Rule. The CalEEMod outputs are provided in Attachment A.

Air Dispersion Modeling

The HRA uses EPA's AERMOD to model annual average DPM and PM_{2.5} concentrations at nearby receptors. Modeling inputs, including emissions rates (in grams of pollutant emitted per second) and source characteristics (e.g., release height, stack diameter, plume width), were based on guidance provided by OEHHA and BAAQMD. Meteorological data were obtained from CARB for the Moffett Federal Airfield location, which is the nearest monitoring station, located approximately 3 miles east of the project site.

Construction equipment emissions were characterized as an area source (AREAPOLY) with a release height of 0.9 meters for fugitive dust emissions and 4.1 meters for all other emissions. One construction area

¹ Bay Area Air Quality Management District. 2016. *BAAQMD Air Toxics NSR Program Health Risk Assessment Guidelines*. December. Available: https://www.baaqmd.gov/~media/files/planning-and-research/permit-modeling/hra_guidelines_12_7_2016_clean-pdf.pdf?la=en. Accessed: March 31, 2020.

² Office of Environmental Health Hazard Assessment. 2015. *Risk Assessment Guidelines*. February. Available: <https://oehha.ca.gov/media/downloads/cnr/2015guidancemanual.pdf>. Accessed: March 31, 2020.

source was modeled, and haul and vendor truck emissions were characterized as line/area sources (LINEAREA) with a release height of 3.4 meters. Worker commute vehicles were also modeled as a line/area source with a release height of 1.3 meters. Emissions from off-road equipment were assumed to be generated throughout the construction footprint area. Emissions from off-site trucks were modeled segments adjacent to the construction footprint California Street and San Antonio Road.

The modeling of emissions from construction activities was based on the construction hours and days (7:30 a.m. to 4:00 p.m., five days per week) during 2022 through 2024. To account for plume rise associated with mechanically generated construction emissions sources for the AERMOD run, the initial vertical dimension of the area source was modeled at 3.81 meters; for the line/area sources, it was modeled at 3.16 meters. The urban dispersion option was used based on the project site's characteristics.

Offsite sensitive receptors were placed at individual homes in all directions within 1,000 feet of the construction work areas and haul roads. A 25-by-25-meter receptor grid was used to place receptors.

Risk Calculations

The risk calculations incorporate OEHHA's age-specific factors that account for increased sensitivity to carcinogens during early-in-life exposure. The approach for estimating cancer risk from long-term inhalation, with exposure to carcinogens, requires calculating a range of potential doses and multiplying by cancer potency factors in units corresponding to the inverse dose to obtain a range of cancer risks. For cancer risk, the risk for each age group is calculated using the appropriate daily breathing rates, age sensitivity factors, and exposure durations. The cancer risks calculated for individual age groups are summed to estimate the cancer risk for each receptor. Chronic cancer and hazard risks were calculated using OEHHA's 2015 HRA guidance.³ The risk calculations and additional assumptions are provided in Attachment B.

³ Office of Environmental Health Hazard Assessment. 2015. *Risk Assessment Guidelines*. February. Available: <https://oehha.ca.gov/media/downloads/cnr/2015guidancemanual.pdf>. Accessed: September 15, 2021.

Attachment A – CalEEMod Output Files for Health Risk Assessment

The Village at San Antonio Center - Phase III Project - Santa Clara County, Annual

EMFAC Off-Model Adjustment Factors for Gasoline Light Duty Vehicle to Account for the SAFE Vehicle Rule Applied

tblConstructionPhase	NumDays	230.00	43.00
tblConstructionPhase	NumDays	230.00	463.00
tblConstructionPhase	NumDays	230.00	23.00
tblConstructionPhase	NumDays	20.00	21.00
tblConstructionPhase	NumDays	20.00	91.00
tblConstructionPhase	NumDays	10.00	50.00
tblGrading	MaterialExported	0.00	55,350.00
tblGrading	MaterialImported	0.00	165.00
tblLandUse	LandUseSquareFeet	169,380.00	169,382.00
tblOffRoadEquipment	HorsePower	231.00	175.00
tblOffRoadEquipment	HorsePower	158.00	273.00
tblOffRoadEquipment	HorsePower	158.00	273.00
tblOffRoadEquipment	HorsePower	89.00	62.00
tblOffRoadEquipment	HorsePower	89.00	62.00
tblOffRoadEquipment	HorsePower	97.00	202.00
tblOffRoadEquipment	HorsePower	97.00	78.00
tblOffRoadEquipment	HorsePower	63.00	80.00
tblOffRoadEquipment	HorsePower	63.00	80.00
tblOffRoadEquipment	HorsePower	221.00	236.00
tblOffRoadEquipment	HorsePower	221.00	275.00
tblOffRoadEquipment	HorsePower	221.00	375.00
tblOffRoadEquipment	HorsePower	212.00	173.00
tblOffRoadEquipment	HorsePower	158.00	80.00
tblOffRoadEquipment	HorsePower	158.00	80.00
tblOffRoadEquipment	HorsePower	158.00	80.00
tblOffRoadEquipment	HorsePower	8.00	248.00
tblOffRoadEquipment	HorsePower	8.00	248.00
tblOffRoadEquipment	HorsePower	64.00	210.00
tblOffRoadEquipment	HorsePower	64.00	210.00
tblOffRoadEquipment	LoadFactor	0.38	0.73
tblOffRoadEquipment	LoadFactor	0.46	0.38
tblOffRoadEquipment	OffRoadEquipmentUnitAmount	3.00	2.00
tblOffRoadEquipment	OffRoadEquipmentUnitAmount	3.00	1.00
tblOffRoadEquipment	OffRoadEquipmentUnitAmount	3.00	1.00
tblOffRoadEquipment	OffRoadEquipmentUnitAmount	3.00	1.00
tblOffRoadEquipment	OffRoadEquipmentUnitAmount	4.00	1.00
tblOffRoadEquipment	OffRoadEquipmentUnitAmount	1.00	2.00
tblOffRoadEquipment	UsageHours	7.00	8.00
tblTripsAndVMT	VendorTripNumber	0.00	3.00
tblTripsAndVMT	VendorTripNumber	0.00	72.00
tblTripsAndVMT	VendorTripNumber	48.00	16.00
tblTripsAndVMT	VendorTripNumber	48.00	4.00
tblTripsAndVMT	VendorTripNumber	0.00	2.00
tblTripsAndVMT	VendorTripNumber	48.00	1.00
tblTripsAndVMT	WorkerTripNumber	8.00	20.00
tblTripsAndVMT	WorkerTripNumber	20.00	40.00
tblTripsAndVMT	WorkerTripNumber	106.00	90.00
tblTripsAndVMT	WorkerTripNumber	106.00	200.00
tblTripsAndVMT	WorkerTripNumber	5.00	120.00
tblTripsAndVMT	WorkerTripNumber	106.00	60.00

2.0 Emissions Summary

2.1 Overall Construction

Unmitigated Construction

The Village at San Antonio Center - Phase III Project - Santa Clara County, Annual

EMFAC Off-Model Adjustment Factors for Gasoline Light Duty Vehicle to Account for the SAFE Vehicle Rule Applied

	ROG	NOx	CO	SO2	Fugitive PM10	Exhaust PM10	PM10 Total	Fugitive PM2.5	Exhaust PM2.5	PM2.5 Total	Bio- CO2	NBio- CO2	Total CO2	CH4	N2O	CO2e
Year	tons/yr										MT/yr					
2022	0.2598	2.6067	2.3836	8.8800e-003	0.2384	0.0839	0.3224	0.0594	0.0790	0.1384	0.0000	811.7450	811.7450	0.1314	0.0495	829.7884
2023	0.2271	1.3905	2.4554	4.7000e-003	0.2096	0.0576	0.2673	0.0558	0.0556	0.1114	0.0000	411.6539	411.6539	0.0522	5.8900e-003	414.7153
2024	0.0917	0.5520	1.0538	2.0700e-003	0.1055	0.0212	0.1266	0.0281	0.0203	0.0484	0.0000	183.4927	183.4927	0.0233	2.7700e-003	184.9018
Maximum	0.2598	2.6067	2.4554	8.8800e-003	0.2384	0.0839	0.3224	0.0594	0.0790	0.1384	0.0000	811.7450	811.7450	0.1314	0.0495	829.7884

Mitigated Construction

	ROG	NOx	CO	SO2	Fugitive PM10	Exhaust PM10	PM10 Total	Fugitive PM2.5	Exhaust PM2.5	PM2.5 Total	Bio- CO2	NBio- CO2	Total CO2	CH4	N2O	CO2e
Year	tons/yr										MT/yr					
2022	0.1256	1.2432	3.1426	8.8800e-003	0.2384	0.0160	0.2544	0.0594	0.0156	0.0751	0.0000	811.7446	811.7446	0.1314	0.0495	829.7879
2023	0.1041	0.5102	2.5475	4.7000e-003	0.2096	5.3100e-003	0.2149	0.0558	5.2200e-003	0.0611	0.0000	411.6536	411.6536	0.0522	5.8900e-003	414.7150
2024	0.0467	0.1991	1.0967	2.0700e-003	0.1055	2.3000e-003	0.1078	0.0281	2.2600e-003	0.0303	0.0000	183.4926	183.4926	0.0233	2.7700e-003	184.9017
Maximum	0.1256	1.2432	3.1426	8.8800e-003	0.2384	0.0160	0.2544	0.0594	0.0156	0.0751	0.0000	811.7446	811.7446	0.1314	0.0495	829.7879

	ROG	NOx	CO	SO2	Fugitive PM10	Exhaust PM10	PM10 Total	Fugitive PM2.5	Exhaust PM2.5	PM2.5 Total	Bio- CO2	NBio- CO2	Total CO2	CH4	N2O	CO2e
Percent Reduction	52.23	57.08	-15.17	0.00	0.00	85.48	19.43	0.00	85.08	44.18	0.00	0.00	0.00	0.00	0.00	0.00

Quarter	Start Date	End Date	Maximum Unmitigated ROG + NOX (tons/quarter)	Maximum Mitigated ROG + NOX (tons/quarter)
1	1-4-2022	4-3-2022	0.9662	0.5241
2	4-4-2022	7-3-2022	1.0115	0.5329
3	7-4-2022	10-3-2022	0.4484	0.1444
4	10-4-2022	1-3-2023	0.4406	0.1622
5	1-4-2023	4-3-2023	0.4024	0.1543
6	4-4-2023	7-3-2023	0.4039	0.1531
7	7-4-2023	10-3-2023	0.4084	0.1549
8	10-4-2023	1-3-2024	0.4108	0.1578
9	1-4-2024	4-3-2024	0.4190	0.1667
10	4-4-2024	7-3-2024	0.2091	0.0743
		Highest	1.0115	0.5329

3.0 Construction Detail

Construction Phase

Phase Number	Phase Name	Phase Type	Start Date	End Date	Num Days Week	Num Days	Phase Description
1	Demolition	Demolition	1/4/2022	2/1/2022	5	21	
2	Excavation-Shoring-Grading	Grading	2/2/2022	6/8/2022	5	91	
3	Foundation	Building Construction	6/9/2022	8/8/2022	5	43	
4	Building Structure-Exterior Systems	Building Construction	8/2/2022	5/9/2024	5	463	
5	Site Improvements	Site Preparation	2/16/2024	4/25/2024	5	50	
6	Final Closeout	Building Construction	5/10/2024	6/11/2024	5	23	

The Village at San Antonio Center - Phase III Project - Santa Clara County, Annual

EMFAC Off-Model Adjustment Factors for Gasoline Light Duty Vehicle to Account for the SAFE Vehicle Rule Applied

Acres of Grading (Site Preparation Phase): 0

Acres of Grading (Grading Phase): 45.5

Acres of Paving: 2.55

Residential Indoor: 0; Residential Outdoor: 0; Non-Residential Indoor: 0; Non-Residential Outdoor: 0; Striped Parking Area: 0 (Architectural Coating –

OffRoad Equipment

Phase Name	Offroad Equipment Type	Amount	Usage Hours	Horse Power	Load Factor
Demolition	Excavators	2	8.00	273	0.73
Demolition	Sweepers/Scrubbers	1	4.00	210	0.38
Excavation-Shoring-Grading	Bore/Drill Rigs	1	8.00	236	0.50
Excavation-Shoring-Grading	Bore/Drill Rigs	1	8.00	276	0.50
Excavation-Shoring-Grading	Bore/Drill Rigs	1	8.00	376	0.50
Excavation-Shoring-Grading	Crawler Tractors	1	8.00	173	0.43
Excavation-Shoring-Grading	Excavators	1	8.00	273	0.38
Excavation-Shoring-Grading	Plate Compactors	1	8.00	248	0.43
Excavation-Shoring-Grading	Sweepers/Scrubbers	1	4.00	210	0.46
Excavation-Shoring-Grading	Tractors/Loaders/Backhoes	1	8.00	202	0.37
Foundation	Cranes	1	8.00	175	0.29
Foundation	Excavators	1	8.00	80	0.38
Foundation	Forklifts	1	8.00	62	0.20
Foundation	Pumps	1	8.00	84	0.74
Building Structure-Exterior Systems	Aerial Lifts	2	8.00	80	0.31
Building Structure-Exterior Systems	Excavators	2	8.00	80	0.38
Building Structure-Exterior Systems	Forklifts	1	8.00	62	0.20
Building Structure-Exterior Systems	Pumps	1	8.00	84	0.74
Building Structure-Exterior Systems	Welders	2	8.00	46	0.45
Site Improvements	Plate Compactors	1	8.00	248	0.43
Site Improvements	Tractors/Loaders/Backhoes	1	8.00	78	0.37
Final Closeout	Aerial Lifts	1	8.00	80	0.31
Final Closeout	Excavators	2	8.00	80	0.38

Trips and VMT

Phase Name	Offroad Equipment Count	Worker Trip Number	Vendor Trip Number	Hauling Trip Number	Worker Trip Length	Vendor Trip Length	Hauling Trip Length	Worker Vehicle Class	Vendor Vehicle Class	Hauling Vehicle Class
Demolition	3	20.00	3.00	76.00	10.80	7.30	20.00	LD_Mix	HDT_Mix	HHDT
Excavation-Shoring-Grading	8	40.00	72.00	6,939.00	10.80	7.30	20.00	LD_Mix	HDT_Mix	HHDT
Foundation	4	90.00	16.00	0.00	10.80	7.30	20.00	LD_Mix	HDT_Mix	HHDT
Building Structure-Exterior Systems	8	200.00	4.00	0.00	10.80	7.30	20.00	LD_Mix	HDT_Mix	HHDT
Site Improvements	2	120.00	2.00	0.00	10.80	7.30	20.00	LD_Mix	HDT_Mix	HHDT
Final Closeout	3	60.00	1.00	0.00	10.80	7.30	20.00	LD_Mix	HDT_Mix	HHDT

3.1 Mitigation Measures Construction

Use Cleaner Engines for Construction Equipment

3.2 Demolition - 2022

Unmitigated Construction On-Site

	ROG	NOx	CO	SO2	Fugitive PM10	Exhaust PM10	PM10 Total	Fugitive PM2.5	Exhaust PM2.5	PM2.5 Total	Bio- CO2	NBio- CO2	Total CO2	CH4	N2O	CO2e
Category	tons/yr										MT/yr					
Fugitive Dust					8.2800e-003	0.0000	8.2800e-003	1.2500e-003	0.0000	1.2500e-003	0.0000	0.0000	0.0000	0.0000	0.0000	0.0000
Off-Road	0.0106	0.0886	0.0865	3.9000e-004	2.9500e-003	2.9500e-003	2.9500e-003	2.7100e-003	2.7100e-003	2.7100e-003	0.0000	34.6038	34.6038	0.0112	0.0000	34.8836
Total	0.0106	0.0886	0.0865	3.9000e-004	8.2800e-003	2.9500e-003	0.0112	1.2500e-003	2.7100e-003	3.9600e-003	0.0000	34.6038	34.6038	0.0112	0.0000	34.8836

The Village at San Antonio Center - Phase III Project - Santa Clara County, Annual

EMFAC Off-Model Adjustment Factors for Gasoline Light Duty Vehicle to Account for the SAFE Vehicle Rule Applied

Unmitigated Construction Off-Site

	ROG	NOx	CO	SO2	Fugitive PM10	Exhaust PM10	PM10 Total	Fugitive PM2.5	Exhaust PM2.5	PM2.5 Total	Bio- CO2	NBio- CO2	Total CO2	CH4	N2O	CO2e
Category	tons/yr										MT/yr					
Hauling	1.8000e-004	6.5800e-003	1.3800e-003	2.0000e-005	6.4000e-004	6.0000e-005	7.0000e-004	1.8000e-004	6.0000e-005	2.3000e-004	0.0000	2.3917	2.3917	8.0000e-005	3.8000e-004	2.5067
Vendor	7.0000e-005	1.7800e-003	5.2000e-004	1.0000e-005	2.1000e-004	2.0000e-005	2.3000e-004	6.0000e-005	2.0000e-005	8.0000e-005	0.0000	0.6534	0.6534	1.0000e-005	1.0000e-004	0.6825
Worker	5.6000e-004	4.1000e-004	5.0700e-003	1.0000e-005	1.6700e-003	1.0000e-005	1.6700e-003	4.4000e-004	1.0000e-005	4.5000e-004	0.0000	1.3170	1.3170	4.0000e-005	4.0000e-005	1.3293
Total	8.1000e-004	8.7700e-003	6.9700e-003	4.0000e-005	2.5200e-003	9.0000e-005	2.6000e-003	6.8000e-004	9.0000e-005	7.6000e-004	0.0000	4.3621	4.3621	1.3000e-004	5.2000e-004	4.5185

Mitigated Construction On-Site

	ROG	NOx	CO	SO2	Fugitive PM10	Exhaust PM10	PM10 Total	Fugitive PM2.5	Exhaust PM2.5	PM2.5 Total	Bio- CO2	NBio- CO2	Total CO2	CH4	N2O	CO2e
Category	tons/yr										MT/yr					
Fugitive Dust					8.2800e-003	0.0000	8.2800e-003	1.2500e-003	0.0000	1.2500e-003	0.0000	0.0000	0.0000	0.0000	0.0000	0.0000
Off-Road	4.8700e-003	0.0211	0.1786	3.9000e-004		6.5000e-004	6.5000e-004		6.5000e-004	6.5000e-004	0.0000	34.6038	34.6038	0.0112	0.0000	34.8836
Total	4.8700e-003	0.0211	0.1786	3.9000e-004	8.2800e-003	6.5000e-004	8.9300e-003	1.2500e-003	6.5000e-004	1.9000e-003	0.0000	34.6038	34.6038	0.0112	0.0000	34.8836

Mitigated Construction Off-Site

	ROG	NOx	CO	SO2	Fugitive PM10	Exhaust PM10	PM10 Total	Fugitive PM2.5	Exhaust PM2.5	PM2.5 Total	Bio- CO2	NBio- CO2	Total CO2	CH4	N2O	CO2e
Category	tons/yr										MT/yr					
Hauling	1.8000e-004	6.5800e-003	1.3800e-003	2.0000e-005	6.4000e-004	6.0000e-005	7.0000e-004	1.8000e-004	6.0000e-005	2.3000e-004	0.0000	2.3917	2.3917	8.0000e-005	3.8000e-004	2.5067
Vendor	7.0000e-005	1.7800e-003	5.2000e-004	1.0000e-005	2.1000e-004	2.0000e-005	2.3000e-004	6.0000e-005	2.0000e-005	8.0000e-005	0.0000	0.6534	0.6534	1.0000e-005	1.0000e-004	0.6825
Worker	5.6000e-004	4.1000e-004	5.0700e-003	1.0000e-005	1.6700e-003	1.0000e-005	1.6700e-003	4.4000e-004	1.0000e-005	4.5000e-004	0.0000	1.3170	1.3170	4.0000e-005	4.0000e-005	1.3293
Total	8.1000e-004	8.7700e-003	6.9700e-003	4.0000e-005	2.5200e-003	9.0000e-005	2.6000e-003	6.8000e-004	9.0000e-005	7.6000e-004	0.0000	4.3621	4.3621	1.3000e-004	5.2000e-004	4.5185

3.3 Excavation-Shoring-Grading - 2022

Unmitigated Construction On-Site

	ROG	NOx	CO	SO2	Fugitive PM10	Exhaust PM10	PM10 Total	Fugitive PM2.5	Exhaust PM2.5	PM2.5 Total	Bio- CO2	NBio- CO2	Total CO2	CH4	N2O	CO2e
Category	tons/yr										MT/yr					
Fugitive Dust					0.0273	0.0000	0.0273	3.0800e-003	0.0000	3.0800e-003	0.0000	0.0000	0.0000	0.0000	0.0000	0.0000
Off-Road	0.0899	0.8738	0.7561	2.8900e-003		0.0343	0.0343		0.0316	0.0316	0.0000	253.9286	253.9286	0.0821	0.0000	255.9818
Total	0.0899	0.8738	0.7561	2.8900e-003	0.0273	0.0343	0.0616	3.0800e-003	0.0316	0.0347	0.0000	253.9286	253.9286	0.0821	0.0000	255.9818

The Village at San Antonio Center - Phase III Project - Santa Clara County, Annual

EMFAC Off-Model Adjustment Factors for Gasoline Light Duty Vehicle to Account for the SAFE Vehicle Rule Applied

Unmitigated Construction Off-Site

	ROG	NOx	CO	SO2	Fugitive PM10	Exhaust PM10	PM10 Total	Fugitive PM2.5	Exhaust PM2.5	PM2.5 Total	Bio- CO2	NBio- CO2	Total CO2	CH4	N2O	CO2e
Category	tons/yr										MT/yr					
Hauling	0.0164	0.6007	0.1262	2.2100e-003	0.0589	5.4100e-003	0.0643	0.0162	5.1800e-003	0.0214	0.0000	218.3700	218.3700	7.5100e-003	0.0346	228.8706
Vendor	7.2400e-003	0.1847	0.0540	7.0000e-004	0.0216	1.9400e-003	0.0235	6.2300e-003	1.8500e-003	8.0900e-003	0.0000	67.9484	67.9484	1.5300e-003	0.0100	70.9746
Worker	4.8700e-003	3.5700e-003	0.0439	1.2000e-004	0.0144	8.0000e-005	0.0145	3.8400e-003	7.0000e-005	3.9100e-003	0.0000	11.4138	11.4138	3.5000e-004	3.3000e-004	11.5209
Total	0.0285	0.7889	0.2241	3.0300e-003	0.0949	7.4300e-003	0.1023	0.0263	7.1000e-003	0.0334	0.0000	297.7323	297.7323	9.3900e-003	0.0450	311.3661

Mitigated Construction On-Site

	ROG	NOx	CO	SO2	Fugitive PM10	Exhaust PM10	PM10 Total	Fugitive PM2.5	Exhaust PM2.5	PM2.5 Total	Bio- CO2	NBio- CO2	Total CO2	CH4	N2O	CO2e
Category	tons/yr										MT/yr					
Fugitive Dust					0.0273	0.0000	0.0273	3.0800e-003	0.0000	3.0800e-003	0.0000	0.0000	0.0000	0.0000	0.0000	0.0000
Off-Road	0.0358	0.1553	1.4034	2.8900e-003		4.7800e-003	4.7800e-003		4.7800e-003	4.7800e-003	0.0000	253.9283	253.9283	0.0821	0.0000	255.9814
Total	0.0358	0.1553	1.4034	2.8900e-003	0.0273	4.7800e-003	0.0321	3.0800e-003	4.7800e-003	7.8600e-003	0.0000	253.9283	253.9283	0.0821	0.0000	255.9814

Mitigated Construction Off-Site

	ROG	NOx	CO	SO2	Fugitive PM10	Exhaust PM10	PM10 Total	Fugitive PM2.5	Exhaust PM2.5	PM2.5 Total	Bio- CO2	NBio- CO2	Total CO2	CH4	N2O	CO2e
Category	tons/yr										MT/yr					
Hauling	0.0164	0.6007	0.1262	2.2100e-003	0.0589	5.4100e-003	0.0643	0.0162	5.1800e-003	0.0214	0.0000	218.3700	218.3700	7.5100e-003	0.0346	228.8706
Vendor	7.2400e-003	0.1847	0.0540	7.0000e-004	0.0216	1.9400e-003	0.0235	6.2300e-003	1.8500e-003	8.0900e-003	0.0000	67.9484	67.9484	1.5300e-003	0.0100	70.9746
Worker	4.8700e-003	3.5700e-003	0.0439	1.2000e-004	0.0144	8.0000e-005	0.0145	3.8400e-003	7.0000e-005	3.9100e-003	0.0000	11.4138	11.4138	3.5000e-004	3.3000e-004	11.5209
Total	0.0285	0.7889	0.2241	3.0300e-003	0.0949	7.4300e-003	0.1023	0.0263	7.1000e-003	0.0334	0.0000	297.7323	297.7323	9.3900e-003	0.0450	311.3661

3.4 Foundation - 2022

Unmitigated Construction On-Site

	ROG	NOx	CO	SO2	Fugitive PM10	Exhaust PM10	PM10 Total	Fugitive PM2.5	Exhaust PM2.5	PM2.5 Total	Bio- CO2	NBio- CO2	Total CO2	CH4	N2O	CO2e
Category	tons/yr										MT/yr					
Off-Road	0.0210	0.1985	0.2044	3.1000e-004		0.0107	0.0107		0.0101	0.0101	0.0000	27.3389	27.3389	5.5300e-003	0.0000	27.4772
Total	0.0210	0.1985	0.2044	3.1000e-004		0.0107	0.0107		0.0101	0.0101	0.0000	27.3389	27.3389	5.5300e-003	0.0000	27.4772

The Village at San Antonio Center - Phase III Project - Santa Clara County, Annual

EMFAC Off-Model Adjustment Factors for Gasoline Light Duty Vehicle to Account for the SAFE Vehicle Rule Applied

Unmitigated Construction Off-Site

	ROG	NOx	CO	SO2	Fugitive PM10	Exhaust PM10	PM10 Total	Fugitive PM2.5	Exhaust PM2.5	PM2.5 Total	Bio- CO2	NBio- CO2	Total CO2	CH4	N2O	CO2e
Category	tons/yr										MT/yr					
Hauling	0.0000	0.0000	0.0000	0.0000	0.0000	0.0000	0.0000	0.0000	0.0000	0.0000	0.0000	0.0000	0.0000	0.0000	0.0000	0.0000
Vendor	7.6000e-004	0.0194	5.6700e-003	7.0000e-005	2.2600e-003	2.0000e-004	2.4700e-003	6.5000e-004	1.9000e-004	8.5000e-004	0.0000	7.1350	7.1350	1.6000e-004	1.0500e-003	7.4528
Worker	5.1800e-003	3.8000e-003	0.0467	1.3000e-004	0.0154	8.0000e-005	0.0154	4.0800e-003	7.0000e-005	4.1600e-003	0.0000	12.1350	12.1350	3.7000e-004	3.5000e-004	12.2489
Total	5.9400e-003	0.0232	0.0524	2.0000e-004	0.0176	2.8000e-004	0.0179	4.7300e-003	2.6000e-004	5.0100e-003	0.0000	19.2700	19.2700	5.3000e-004	1.4000e-003	19.7016

Mitigated Construction On-Site

	ROG	NOx	CO	SO2	Fugitive PM10	Exhaust PM10	PM10 Total	Fugitive PM2.5	Exhaust PM2.5	PM2.5 Total	Bio- CO2	NBio- CO2	Total CO2	CH4	N2O	CO2e
Category	tons/yr										MT/yr					
Off-Road	3.8200e-003	0.0270	0.1896	3.1000e-004		4.7000e-004	4.7000e-004		4.7000e-004	4.7000e-004	0.0000	27.3389	27.3389	5.5300e-003	0.0000	27.4772
Total	3.8200e-003	0.0270	0.1896	3.1000e-004		4.7000e-004	4.7000e-004		4.7000e-004	4.7000e-004	0.0000	27.3389	27.3389	5.5300e-003	0.0000	27.4772

Mitigated Construction Off-Site

	ROG	NOx	CO	SO2	Fugitive PM10	Exhaust PM10	PM10 Total	Fugitive PM2.5	Exhaust PM2.5	PM2.5 Total	Bio- CO2	NBio- CO2	Total CO2	CH4	N2O	CO2e
Category	tons/yr										MT/yr					
Hauling	0.0000	0.0000	0.0000	0.0000	0.0000	0.0000	0.0000	0.0000	0.0000	0.0000	0.0000	0.0000	0.0000	0.0000	0.0000	0.0000
Vendor	7.6000e-004	0.0194	5.6700e-003	7.0000e-005	2.2600e-003	2.0000e-004	2.4700e-003	6.5000e-004	1.9000e-004	8.5000e-004	0.0000	7.1350	7.1350	1.6000e-004	1.0500e-003	7.4528
Worker	5.1800e-003	3.8000e-003	0.0467	1.3000e-004	0.0154	8.0000e-005	0.0154	4.0800e-003	7.0000e-005	4.1600e-003	0.0000	12.1350	12.1350	3.7000e-004	3.5000e-004	12.2489
Total	5.9400e-003	0.0232	0.0524	2.0000e-004	0.0176	2.8000e-004	0.0179	4.7300e-003	2.6000e-004	5.0100e-003	0.0000	19.2700	19.2700	5.3000e-004	1.4000e-003	19.7016

3.5 Building Structure-Exterior Systems - 2022

Unmitigated Construction On-Site

	ROG	NOx	CO	SO2	Fugitive PM10	Exhaust PM10	PM10 Total	Fugitive PM2.5	Exhaust PM2.5	PM2.5 Total	Bio- CO2	NBio- CO2	Total CO2	CH4	N2O	CO2e
Category	tons/yr										MT/yr					
Off-Road	0.0734	0.5912	0.7864	1.2100e-003		0.0276	0.0276		0.0266	0.0266	0.0000	101.6303	101.6303	0.0203	0.0000	102.1378
Total	0.0734	0.5912	0.7864	1.2100e-003		0.0276	0.0276		0.0266	0.0266	0.0000	101.6303	101.6303	0.0203	0.0000	102.1378

Unmitigated Construction Off-Site

The Village at San Antonio Center - Phase III Project - Santa Clara County, Annual

EMFAC Off-Model Adjustment Factors for Gasoline Light Duty Vehicle to Account for the SAFE Vehicle Rule Applied

	ROG	NOx	CO	SO2	Fugitive PM10	Exhaust PM10	PM10 Total	Fugitive PM2.5	Exhaust PM2.5	PM2.5 Total	Bio- CO2	NBio- CO2	Total CO2	CH4	N2O	CO2e
Category	tons/yr										MT/yr					
Hauling	0.0000	0.0000	0.0000	0.0000	0.0000	0.0000	0.0000	0.0000	0.0000	0.0000	0.0000	0.0000	0.0000	0.0000	0.0000	0.0000
Vendor	4.8000e-004	0.0123	3.5900e-003	5.0000e-005	1.4300e-003	1.3000e-004	1.5600e-003	4.1000e-004	1.2000e-004	5.4000e-004	0.0000	4.5216	4.5216	1.0000e-004	6.7000e-004	4.7230
Worker	0.0292	0.0214	0.2630	7.4000e-004	0.0865	4.5000e-004	0.0869	0.0230	4.2000e-004	0.0234	0.0000	68.3575	68.3575	2.1000e-003	1.9800e-003	68.9988
Total	0.0297	0.0337	0.2666	7.9000e-004	0.0879	5.8000e-004	0.0885	0.0234	5.4000e-004	0.0240	0.0000	72.8791	72.8791	2.2000e-003	2.6500e-003	73.7218

Mitigated Construction On-Site

	ROG	NOx	CO	SO2	Fugitive PM10	Exhaust PM10	PM10 Total	Fugitive PM2.5	Exhaust PM2.5	PM2.5 Total	Bio- CO2	NBio- CO2	Total CO2	CH4	N2O	CO2e
Category	tons/yr										MT/yr					
Off-Road	0.0162	0.1852	0.8210	1.2100e-003		1.7400e-003	1.7400e-003		1.7400e-003	1.7400e-003	0.0000	101.6302	101.6302	0.0203	0.0000	102.1376
Total	0.0162	0.1852	0.8210	1.2100e-003		1.7400e-003	1.7400e-003		1.7400e-003	1.7400e-003	0.0000	101.6302	101.6302	0.0203	0.0000	102.1376

Mitigated Construction Off-Site

	ROG	NOx	CO	SO2	Fugitive PM10	Exhaust PM10	PM10 Total	Fugitive PM2.5	Exhaust PM2.5	PM2.5 Total	Bio- CO2	NBio- CO2	Total CO2	CH4	N2O	CO2e
Category	tons/yr										MT/yr					
Hauling	0.0000	0.0000	0.0000	0.0000	0.0000	0.0000	0.0000	0.0000	0.0000	0.0000	0.0000	0.0000	0.0000	0.0000	0.0000	0.0000
Vendor	4.8000e-004	0.0123	3.5900e-003	5.0000e-005	1.4300e-003	1.3000e-004	1.5600e-003	4.1000e-004	1.2000e-004	5.4000e-004	0.0000	4.5216	4.5216	1.0000e-004	6.7000e-004	4.7230
Worker	0.0292	0.0214	0.2630	7.4000e-004	0.0865	4.5000e-004	0.0869	0.0230	4.2000e-004	0.0234	0.0000	68.3575	68.3575	2.1000e-003	1.9800e-003	68.9988
Total	0.0297	0.0337	0.2666	7.9000e-004	0.0879	5.8000e-004	0.0885	0.0234	5.4000e-004	0.0240	0.0000	72.8791	72.8791	2.2000e-003	2.6500e-003	73.7218

3.5 Building Structure-Exterior Systems - 2023

Unmitigated Construction On-Site

	ROG	NOx	CO	SO2	Fugitive PM10	Exhaust PM10	PM10 Total	Fugitive PM2.5	Exhaust PM2.5	PM2.5 Total	Bio- CO2	NBio- CO2	Total CO2	CH4	N2O	CO2e
Category	tons/yr										MT/yr					
Off-Road	0.1616	1.3221	1.8662	2.8900e-003		0.0565	0.0565		0.0545	0.0545	0.0000	242.3617	242.3617	0.0475	0.0000	243.5490
Total	0.1616	1.3221	1.8662	2.8900e-003		0.0565	0.0565		0.0545	0.0545	0.0000	242.3617	242.3617	0.0475	0.0000	243.5490

Unmitigated Construction Off-Site

The Village at San Antonio Center - Phase III Project - Santa Clara County, Annual

EMFAC Off-Model Adjustment Factors for Gasoline Light Duty Vehicle to Account for the SAFE Vehicle Rule Applied

	ROG	NOx	CO	SO2	Fugitive PM10	Exhaust PM10	PM10 Total	Fugitive PM2.5	Exhaust PM2.5	PM2.5 Total	Bio- CO2	NBio- CO2	Total CO2	CH4	N2O	CO2e
Category	tons/yr										MT/yr					
Hauling	0.0000	0.0000	0.0000	0.0000	0.0000	0.0000	0.0000	0.0000	0.0000	0.0000	0.0000	0.0000	0.0000	0.0000	0.0000	0.0000
Vendor	5.7000e-004	0.0232	7.3000e-003	1.1000e-004	3.4200e-003	1.4000e-004	3.5600e-003	9.9000e-004	1.3000e-004	1.1200e-003	0.0000	10.3392	10.3392	2.2000e-004	1.5200e-003	10.7973
Worker	0.0650	0.0453	0.5819	1.7100e-003	0.2062	1.0200e-003	0.2072	0.0548	9.4000e-004	0.0558	0.0000	158.9530	158.9530	4.5300e-003	4.3700e-003	160.3690
Total	0.0656	0.0684	0.5892	1.8200e-003	0.2096	1.1600e-003	0.2108	0.0558	1.0700e-003	0.0569	0.0000	169.2922	169.2922	4.7500e-003	5.8900e-003	171.1663

Mitigated Construction On-Site

	ROG	NOx	CO	SO2	Fugitive PM10	Exhaust PM10	PM10 Total	Fugitive PM2.5	Exhaust PM2.5	PM2.5 Total	Bio- CO2	NBio- CO2	Total CO2	CH4	N2O	CO2e
Category	tons/yr										MT/yr					
Off-Road	0.0385	0.4418	1.9583	2.8900e-003		4.1500e-003	4.1500e-003		4.1500e-003	4.1500e-003	0.0000	242.3614	242.3614	0.0475	0.0000	243.5487
Total	0.0385	0.4418	1.9583	2.8900e-003		4.1500e-003	4.1500e-003		4.1500e-003	4.1500e-003	0.0000	242.3614	242.3614	0.0475	0.0000	243.5487

Mitigated Construction Off-Site

	ROG	NOx	CO	SO2	Fugitive PM10	Exhaust PM10	PM10 Total	Fugitive PM2.5	Exhaust PM2.5	PM2.5 Total	Bio- CO2	NBio- CO2	Total CO2	CH4	N2O	CO2e
Category	tons/yr										MT/yr					
Hauling	0.0000	0.0000	0.0000	0.0000	0.0000	0.0000	0.0000	0.0000	0.0000	0.0000	0.0000	0.0000	0.0000	0.0000	0.0000	0.0000
Vendor	5.7000e-004	0.0232	7.3000e-003	1.1000e-004	3.4200e-003	1.4000e-004	3.5600e-003	9.9000e-004	1.3000e-004	1.1200e-003	0.0000	10.3392	10.3392	2.2000e-004	1.5200e-003	10.7973
Worker	0.0650	0.0453	0.5819	1.7100e-003	0.2062	1.0200e-003	0.2072	0.0548	9.4000e-004	0.0558	0.0000	158.9530	158.9530	4.5300e-003	4.3700e-003	160.3690
Total	0.0656	0.0684	0.5892	1.8200e-003	0.2096	1.1600e-003	0.2108	0.0558	1.0700e-003	0.0569	0.0000	169.2922	169.2922	4.7500e-003	5.8900e-003	171.1663

3.5 Building Structure-Exterior Systems - 2024

Unmitigated Construction On-Site

	ROG	NOx	CO	SO2	Fugitive PM10	Exhaust PM10	PM10 Total	Fugitive PM2.5	Exhaust PM2.5	PM2.5 Total	Bio- CO2	NBio- CO2	Total CO2	CH4	N2O	CO2e
Category	tons/yr										MT/yr					
Off-Road	0.0547	0.4560	0.6730	1.0400e-003		0.0179	0.0179		0.0173	0.0173	0.0000	87.6334	87.6334	0.0170	0.0000	88.0585
Total	0.0547	0.4560	0.6730	1.0400e-003		0.0179	0.0179		0.0173	0.0173	0.0000	87.6334	87.6334	0.0170	0.0000	88.0585

Unmitigated Construction Off-Site

	ROG	NOx	CO	SO2	Fugitive PM10	Exhaust PM10	PM10 Total	Fugitive PM2.5	Exhaust PM2.5	PM2.5 Total	Bio- CO2	NBio- CO2	Total CO2	CH4	N2O	CO2e
--	-----	-----	----	-----	---------------	--------------	------------	----------------	---------------	-------------	----------	-----------	-----------	-----	-----	------

The Village at San Antonio Center - Phase III Project - Santa Clara County, Annual

EMFAC Off-Model Adjustment Factors for Gasoline Light Duty Vehicle to Account for the SAFE Vehicle Rule Applied

Category	tons/yr										MT/yr					
	Hauling	0.0000	0.0000	0.0000	0.0000	0.0000	0.0000	0.0000	0.0000	0.0000	0.0000	0.0000	0.0000	0.0000	0.0000	0.0000
Vendor	2.0000e-004	8.3800e-003	2.5900e-003	4.0000e-005	1.2400e-003	5.0000e-005	1.2900e-003	3.6000e-004	5.0000e-005	4.1000e-004	0.0000	3.6830	3.6830	8.0000e-005	5.4000e-004	3.8459
Worker	0.0220	0.0146	0.1967	6.0000e-004	0.0746	3.5000e-004	0.0749	0.0198	3.2000e-004	0.0202	0.0000	56.0732	56.0732	1.4900e-003	1.4700e-003	56.5498
Total	0.0222	0.0230	0.1993	6.4000e-004	0.0758	4.0000e-004	0.0762	0.0202	3.7000e-004	0.0206	0.0000	59.7563	59.7563	1.5700e-003	2.0100e-003	60.3957

Mitigated Construction On-Site

Category	ROG	NOx	CO	SO2	Fugitive PM10	Exhaust PM10	PM10 Total	Fugitive PM2.5	Exhaust PM2.5	PM2.5 Total	Bio- CO2	NBio- CO2	Total CO2	CH4	N2O	CO2e
	tons/yr										MT/yr					
Off-Road	0.0139	0.1597	0.7080	1.0400e-003		1.5000e-003	1.5000e-003		1.5000e-003	1.5000e-003	0.0000	87.6333	87.6333	0.0170	0.0000	88.0584
Total	0.0139	0.1597	0.7080	1.0400e-003		1.5000e-003	1.5000e-003		1.5000e-003	1.5000e-003	0.0000	87.6333	87.6333	0.0170	0.0000	88.0584

Mitigated Construction Off-Site

Category	ROG	NOx	CO	SO2	Fugitive PM10	Exhaust PM10	PM10 Total	Fugitive PM2.5	Exhaust PM2.5	PM2.5 Total	Bio- CO2	NBio- CO2	Total CO2	CH4	N2O	CO2e
	tons/yr										MT/yr					
Hauling	0.0000	0.0000	0.0000	0.0000	0.0000	0.0000	0.0000	0.0000	0.0000	0.0000	0.0000	0.0000	0.0000	0.0000	0.0000	0.0000
Vendor	2.0000e-004	8.3800e-003	2.5900e-003	4.0000e-005	1.2400e-003	5.0000e-005	1.2900e-003	3.6000e-004	5.0000e-005	4.1000e-004	0.0000	3.6830	3.6830	8.0000e-005	5.4000e-004	3.8459
Worker	0.0220	0.0146	0.1967	6.0000e-004	0.0746	3.5000e-004	0.0749	0.0198	3.2000e-004	0.0202	0.0000	56.0732	56.0732	1.4900e-003	1.4700e-003	56.5498
Total	0.0222	0.0230	0.1993	6.4000e-004	0.0758	4.0000e-004	0.0762	0.0202	3.7000e-004	0.0206	0.0000	59.7563	59.7563	1.5700e-003	2.0100e-003	60.3957

3.6 Site Improvements - 2024

Unmitigated Construction On-Site

Category	ROG	NOx	CO	SO2	Fugitive PM10	Exhaust PM10	PM10 Total	Fugitive PM2.5	Exhaust PM2.5	PM2.5 Total	Bio- CO2	NBio- CO2	Total CO2	CH4	N2O	CO2e
	tons/yr										MT/yr					
Fugitive Dust					0.0000	0.0000	0.0000	0.0000	0.0000	0.0000	0.0000	0.0000	0.0000	0.0000	0.0000	0.0000
Off-Road	2.8900e-003	0.0291	0.0449	6.0000e-005		1.3400e-003	1.3400e-003		1.2300e-003	1.2300e-003	0.0000	5.5034	5.5034	1.7800e-003	0.0000	5.5479
Total	2.8900e-003	0.0291	0.0449	6.0000e-005	0.0000	1.3400e-003	1.3400e-003	0.0000	1.2300e-003	1.2300e-003	0.0000	5.5034	5.5034	1.7800e-003	0.0000	5.5479

Unmitigated Construction Off-Site

Category	ROG	NOx	CO	SO2	Fugitive PM10	Exhaust PM10	PM10 Total	Fugitive PM2.5	Exhaust PM2.5	PM2.5 Total	Bio- CO2	NBio- CO2	Total CO2	CH4	N2O	CO2e
----------	-----	-----	----	-----	---------------	--------------	------------	----------------	---------------	-------------	----------	-----------	-----------	-----	-----	------

The Village at San Antonio Center - Phase III Project - Santa Clara County, Annual

EMFAC Off-Model Adjustment Factors for Gasoline Light Duty Vehicle to Account for the SAFE Vehicle Rule Applied

Category	tons/yr										MT/yr					
	Hauling	0.0000	0.0000	0.0000	0.0000	0.0000	0.0000	0.0000	0.0000	0.0000	0.0000	0.0000	0.0000	0.0000	0.0000	0.0000
Vendor	5.0000e-005	2.2300e-003	6.9000e-004	1.0000e-005	3.3000e-004	1.0000e-005	3.4000e-004	1.0000e-004	1.0000e-005	1.1000e-004	0.0000	0.9795	0.9795	2.0000e-005	1.4000e-004	1.0229
Worker	7.0300e-003	4.6700e-003	0.0628	1.9000e-004	0.0238	1.1000e-004	0.0239	6.3300e-003	1.0000e-004	6.4300e-003	0.0000	17.8957	17.8957	4.7000e-004	4.7000e-004	18.0478
Total	7.0800e-003	6.9000e-003	0.0635	2.0000e-004	0.0241	1.2000e-004	0.0243	6.4300e-003	1.1000e-004	6.5400e-003	0.0000	18.8752	18.8752	4.9000e-004	6.1000e-004	19.0707

Mitigated Construction On-Site

Category	ROG	NOx	CO	SO2	Fugitive PM10	Exhaust PM10	PM10 Total	Fugitive PM2.5	Exhaust PM2.5	PM2.5 Total	Bio- CO2	NBio- CO2	Total CO2	CH4	N2O	CO2e
	tons/yr										MT/yr					
Fugitive Dust					0.0000	0.0000	0.0000	0.0000	0.0000	0.0000	0.0000	0.0000	0.0000	0.0000	0.0000	0.0000
Off-Road	7.6000e-004	3.3100e-003	0.0471	6.0000e-005		1.0000e-004	1.0000e-004		1.0000e-004	1.0000e-004	0.0000	5.5034	5.5034	1.7800e-003	0.0000	5.5479
Total	7.6000e-004	3.3100e-003	0.0471	6.0000e-005	0.0000	1.0000e-004	1.0000e-004	0.0000	1.0000e-004	1.0000e-004	0.0000	5.5034	5.5034	1.7800e-003	0.0000	5.5479

Mitigated Construction Off-Site

Category	ROG	NOx	CO	SO2	Fugitive PM10	Exhaust PM10	PM10 Total	Fugitive PM2.5	Exhaust PM2.5	PM2.5 Total	Bio- CO2	NBio- CO2	Total CO2	CH4	N2O	CO2e
	tons/yr										MT/yr					
Hauling	0.0000	0.0000	0.0000	0.0000	0.0000	0.0000	0.0000	0.0000	0.0000	0.0000	0.0000	0.0000	0.0000	0.0000	0.0000	0.0000
Vendor	5.0000e-005	2.2300e-003	6.9000e-004	1.0000e-005	3.3000e-004	1.0000e-005	3.4000e-004	1.0000e-004	1.0000e-005	1.1000e-004	0.0000	0.9795	0.9795	2.0000e-005	1.4000e-004	1.0229
Worker	7.0300e-003	4.6700e-003	0.0628	1.9000e-004	0.0238	1.1000e-004	0.0239	6.3300e-003	1.0000e-004	6.4300e-003	0.0000	17.8957	17.8957	4.7000e-004	4.7000e-004	18.0478
Total	7.0800e-003	6.9000e-003	0.0635	2.0000e-004	0.0241	1.2000e-004	0.0243	6.4300e-003	1.1000e-004	6.5400e-003	0.0000	18.8752	18.8752	4.9000e-004	6.1000e-004	19.0707

3.7 Final Closeout - 2024

Unmitigated Construction On-Site

Category	ROG	NOx	CO	SO2	Fugitive PM10	Exhaust PM10	PM10 Total	Fugitive PM2.5	Exhaust PM2.5	PM2.5 Total	Bio- CO2	NBio- CO2	Total CO2	CH4	N2O	CO2e
	tons/yr										MT/yr					
Off-Road	3.1800e-003	0.0354	0.0585	8.0000e-005		1.4000e-003	1.4000e-003		1.2800e-003	1.2800e-003	0.0000	7.3831	7.3831	2.3900e-003	0.0000	7.4428
Total	3.1800e-003	0.0354	0.0585	8.0000e-005		1.4000e-003	1.4000e-003		1.2800e-003	1.2800e-003	0.0000	7.3831	7.3831	2.3900e-003	0.0000	7.4428

Unmitigated Construction Off-Site

Category	ROG	NOx	CO	SO2	Fugitive PM10	Exhaust PM10	PM10 Total	Fugitive PM2.5	Exhaust PM2.5	PM2.5 Total	Bio- CO2	NBio- CO2	Total CO2	CH4	N2O	CO2e
----------	-----	-----	----	-----	---------------	--------------	------------	----------------	---------------	-------------	----------	-----------	-----------	-----	-----	------

The Village at San Antonio Center - Phase III Project - Santa Clara County, Annual

EMFAC Off-Model Adjustment Factors for Gasoline Light Duty Vehicle to Account for the SAFE Vehicle Rule Applied

Category	tons/yr										MT/yr					
	Hauling	0.0000	0.0000	0.0000	0.0000	0.0000	0.0000	0.0000	0.0000	0.0000	0.0000	0.0000	0.0000	0.0000	0.0000	0.0000
Vendor	1.0000e-005	5.1000e-004	1.6000e-004	0.0000	8.0000e-005	0.0000	8.0000e-005	2.0000e-005	0.0000	2.0000e-005	0.0000	0.2253	0.2253	0.0000	3.0000e-005	0.2353
Worker	1.6200e-003	1.0700e-003	0.0144	4.0000e-005	5.4700e-003	3.0000e-005	5.5000e-003	1.4600e-003	2.0000e-005	1.4800e-003	0.0000	4.1160	4.1160	1.1000e-004	1.1000e-004	4.1510
Total	1.6300e-003	1.5800e-003	0.0146	4.0000e-005	5.5500e-003	3.0000e-005	5.5800e-003	1.4800e-003	2.0000e-005	1.5000e-003	0.0000	4.3413	4.3413	1.1000e-004	1.4000e-004	4.3863

Mitigated Construction On-Site

Category	ROG	NOx	CO	SO2	Fugitive PM10	Exhaust PM10	PM10 Total	Fugitive PM2.5	Exhaust PM2.5	PM2.5 Total	Bio- CO2	NBio- CO2	Total CO2	CH4	N2O	CO2e
	tons/yr										MT/yr					
Off-Road	1.0400e-003	4.5100e-003	0.0642	8.0000e-005		1.4000e-004	1.4000e-004		1.4000e-004	1.4000e-004	0.0000	7.3831	7.3831	2.3900e-003	0.0000	7.4428
Total	1.0400e-003	4.5100e-003	0.0642	8.0000e-005		1.4000e-004	1.4000e-004		1.4000e-004	1.4000e-004	0.0000	7.3831	7.3831	2.3900e-003	0.0000	7.4428

Mitigated Construction Off-Site

Category	ROG	NOx	CO	SO2	Fugitive PM10	Exhaust PM10	PM10 Total	Fugitive PM2.5	Exhaust PM2.5	PM2.5 Total	Bio- CO2	NBio- CO2	Total CO2	CH4	N2O	CO2e
	tons/yr										MT/yr					
Hauling	0.0000	0.0000	0.0000	0.0000	0.0000	0.0000	0.0000	0.0000	0.0000	0.0000	0.0000	0.0000	0.0000	0.0000	0.0000	0.0000
Vendor	1.0000e-005	5.1000e-004	1.6000e-004	0.0000	8.0000e-005	0.0000	8.0000e-005	2.0000e-005	0.0000	2.0000e-005	0.0000	0.2253	0.2253	0.0000	3.0000e-005	0.2353
Worker	1.6200e-003	1.0700e-003	0.0144	4.0000e-005	5.4700e-003	3.0000e-005	5.5000e-003	1.4600e-003	2.0000e-005	1.4800e-003	0.0000	4.1160	4.1160	1.1000e-004	1.1000e-004	4.1510
Total	1.6300e-003	1.5800e-003	0.0146	4.0000e-005	5.5500e-003	3.0000e-005	5.5800e-003	1.4800e-003	2.0000e-005	1.5000e-003	0.0000	4.3413	4.3413	1.1000e-004	1.4000e-004	4.3863

Attachment B – Dispersion Modeling Parameters and Health Risk Calculations

Maximum exposed receptor locations:



Wind Rose based on Meteorological Data near the Project Site

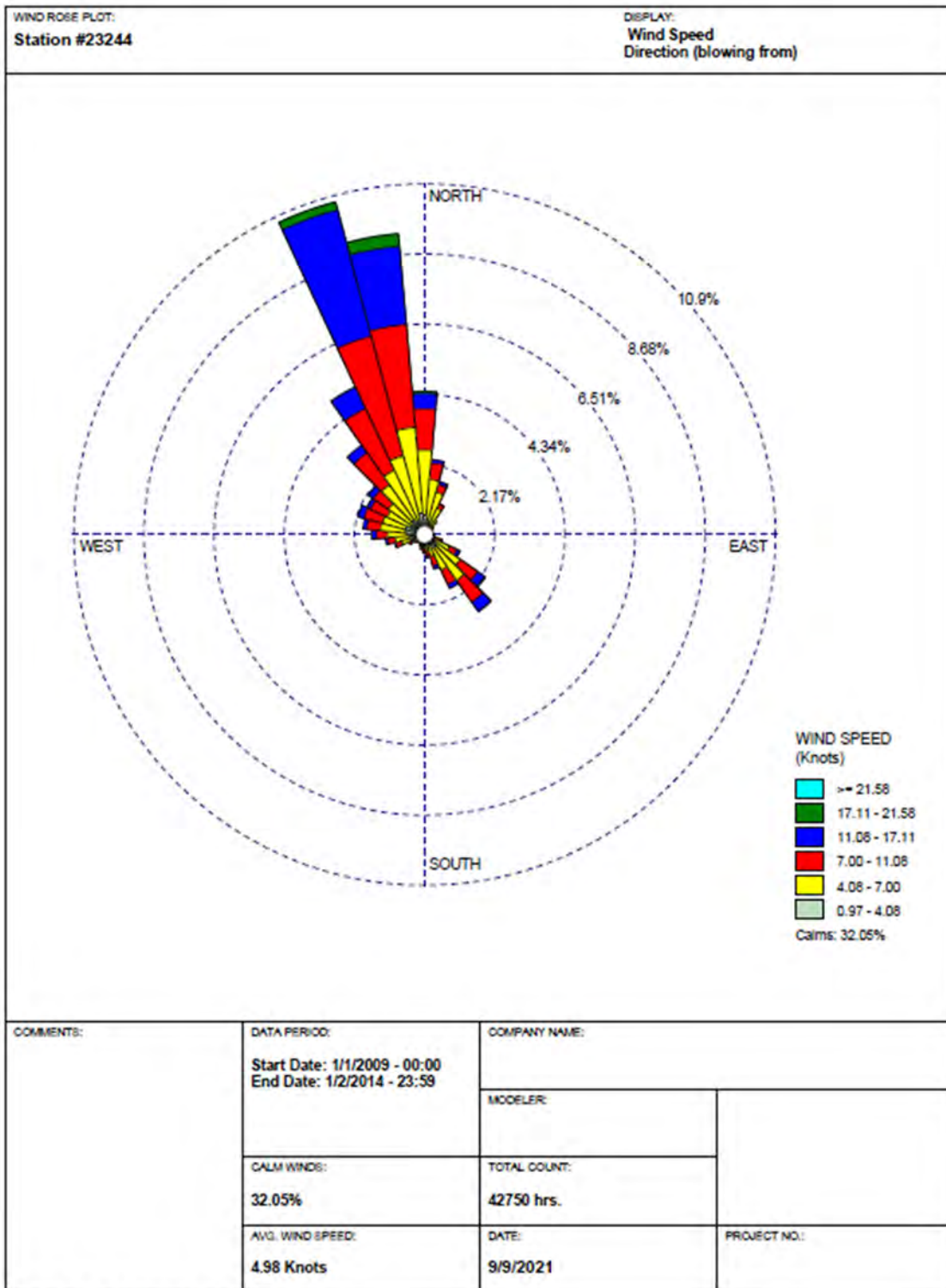

BAAQMD Stationary Source Data

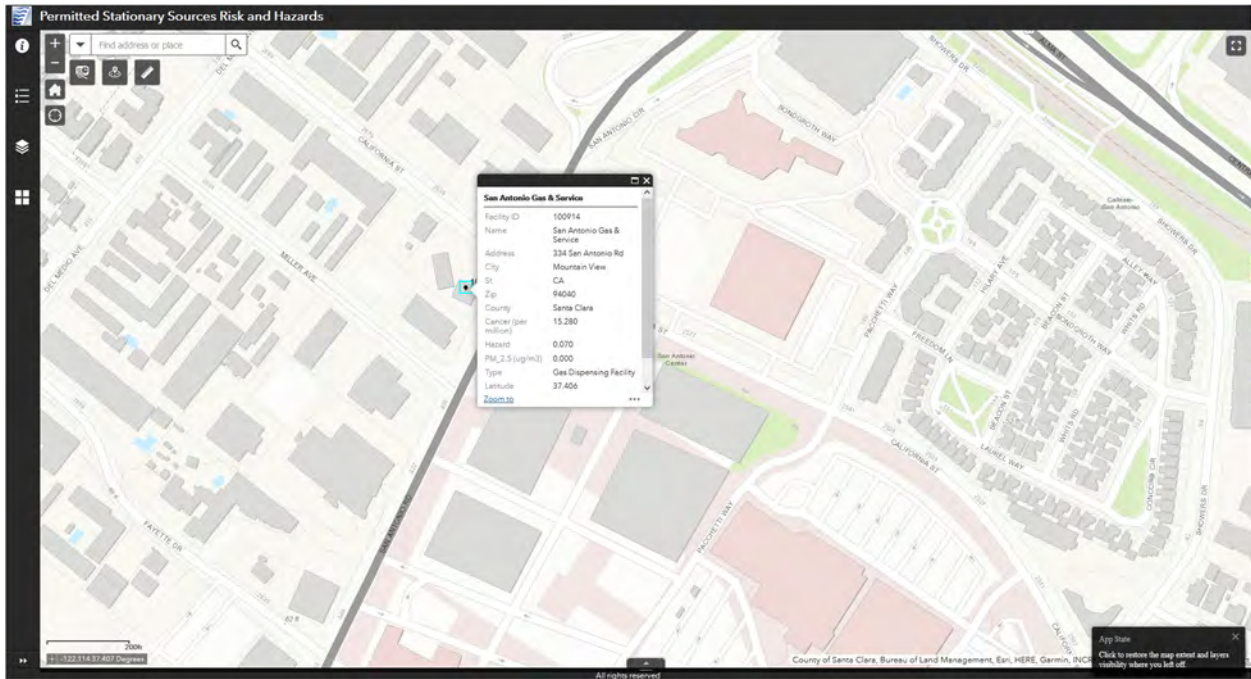

AERMOD Concentrations for Diesel Particulate Matter (On-site Off-Road Equipment; Haul Trucks on California Street and San Antonio Road)

234	578822.54	4140254.74	2.47748	15.48	15.48	0	ANNUAL	PAREA1	5
235	578847.54	4140254.74	1.90062	15.88	15.88	0	ANNUAL	PAREA1	5
236	578872.54	4140254.74	1.48248	15.71	15.71	0	ANNUAL	PAREA1	5
237	578897.54	4140254.74	1.18058	15.73	15.73	0	ANNUAL	PAREA1	5
238	578922.54	4140254.74	0.95708	15.23	15.23	0	ANNUAL	PAREA1	5
239	578947.54	4140254.74	0.79026	15.01	15.01	0	ANNUAL	PAREA1	5
240	578972.54	4140254.74	0.66342	15.27	15.27	0	ANNUAL	PAREA1	5
241	578997.54	4140254.74	0.56369	14.96	14.96	0	ANNUAL	PAREA1	5
242	579022.54	4140254.74	0.48515	15.17	15.17	0	ANNUAL	PAREA1	5
243	579047.54	4140254.74	0.42172	15.18	15.18	0	ANNUAL	PAREA1	5
244	579072.54	4140254.74	0.37007	15.46	15.46	0	ANNUAL	PAREA1	5
245	579097.54	4140254.74	0.32699	14.8	14.8	0	ANNUAL	PAREA1	5
246	578372.54	4140279.74	0.19313	15.92	15.92	0	ANNUAL	PAREA1	5
247	578397.54	4140279.74	0.23444	15.95	15.95	0	ANNUAL	PAREA1	5
248	578422.54	4140279.74	0.289	15.94	15.94	0	ANNUAL	PAREA1	5
249	578447.54	4140279.74	0.36233	15.48	15.48	0	ANNUAL	PAREA1	5
250	578472.54	4140279.74	0.46376	15.4	15.4	0	ANNUAL	PAREA1	5
251	578497.54	4140279.74	0.60714	15.19	15.19	0	ANNUAL	PAREA1	5
252	578522.54	4140279.74	0.81699	15.26	15.26	0	ANNUAL	PAREA1	5
253	578547.54	4140279.74	1.13288	15.33	15.33	0	ANNUAL	PAREA1	5
254	578722.54	4140279.74	5.72127	15.16	15.16	0	ANNUAL	PAREA1	5
255	578747.54	4140279.74	3.87413	15.26	15.26	0	ANNUAL	PAREA1	5
256	578772.54	4140279.74	2.60634	15.15	15.15	0	ANNUAL	PAREA1	5
257	578797.54	4140279.74	1.9516	15.19	15.19	0	ANNUAL	PAREA1	5
258	578822.54	4140279.74	1.58413	15.14	15.14	0	ANNUAL	PAREA1	5
259	578847.54	4140279.74	1.30997	14.92	14.92	0	ANNUAL	PAREA1	5
260	578872.54	4140279.74	1.09191	15.3	15.3	0	ANNUAL	PAREA1	5
261	578897.54	4140279.74	0.91322	14.98	14.98	0	ANNUAL	PAREA1	5
262	578922.54	4140279.74	0.7708	14.82	14.82	0	ANNUAL	PAREA1	5
263	578947.54	4140279.74	0.65685	14.88	14.88	0	ANNUAL	PAREA1	5
264	578972.54	4140279.74	0.56525	15.41	15.41	0	ANNUAL	PAREA1	5
265	578997.54	4140279.74	0.49018	15.76	15.76	0	ANNUAL	PAREA1	5
266	579022.54	4140279.74	0.42806	15.4	15.4	0	ANNUAL	PAREA1	5
267	579047.54	4140279.74	0.3764	14.67	14.67	0	ANNUAL	PAREA1	5
268	579072.54	4140279.74	0.33389	14.97	14.97	0	ANNUAL	PAREA1	5
269	579097.54	4140279.74	0.29785	14.76	14.76	0	ANNUAL	PAREA1	5
270	578372.54	4140304.74	0.22736	15.89	15.89	0	ANNUAL	PAREA1	5
271	578397.54	4140304.74	0.27644	15.53	15.53	0	ANNUAL	PAREA1	5
272	578422.54	4140304.74	0.34098	15.47	15.47	0	ANNUAL	PAREA1	5
273	578447.54	4140304.74	0.42708	15.33	15.33	0	ANNUAL	PAREA1	5
274	578472.54	4140304.74	0.54396	15.12	15.12	0	ANNUAL	PAREA1	5
275	578497.54	4140304.74	0.70579	15.01	15.01	0	ANNUAL	PAREA1	5
276	578522.54	4140304.74	0.93326	14.89	14.89	0	ANNUAL	PAREA1	5
277	578547.54	4140304.74	1.25866	15.04	15.04	0	ANNUAL	PAREA1	5
278	578572.54	4140304.74	1.72255	15.13	15.13	0	ANNUAL	PAREA1	5
279	578647.54	4140304.74	4.10215	15.1	15.1	0	ANNUAL	PAREA1	5
280	578672.54	4140304.74	4.6468	15.44	15.44	0	ANNUAL	PAREA1	5
281	578747.54	4140304.74	2.25093	15.24	15.24	0	ANNUAL	PAREA1	5
282	578772.54	4140304.74	1.60261	14.94	14.94	0	ANNUAL	PAREA1	5
283	578797.54	4140304.74	1.25895	14.95	14.95	0	ANNUAL	PAREA1	5
284	578822.54	4140304.74	1.06458	14.88	14.88	0	ANNUAL	PAREA1	5
285	578847.54	4140304.74	0.92412	15.04	15.04	0	ANNUAL	PAREA1	5
286	578872.54	4140304.74	0.80303	14.63	14.63	0	ANNUAL	PAREA1	5
287	578897.54	4140304.74	0.68863	14.14	14.14	0	ANNUAL	PAREA1	5
288	578922.54	4140304.74	0.61135	14.38	14.38	0	ANNUAL	PAREA1	5
289	578947.54	4140304.74	0.53721	14.99	14.99	0	ANNUAL	PAREA1	5
290	578972.54	4140304.74	0.47354	15.52	15.52	0	ANNUAL	PAREA1	5
291	578997.54	4140304.74	0.41892	15.88	15.88	0	ANNUAL	PAREA1	5
292	579022.54	4140304.74	0.37194	15.25	15.25	0	ANNUAL	PAREA1	5
293	579047.54	4140304.74	0.33151	14.27	14.27	0	ANNUAL	PAREA1	5
294	579072.54	4140304.74	0.29739	14.15	14.15	0	ANNUAL	PAREA1	5
295	579097.54	4140304.74	0.26815	14.29	14.29	0	ANNUAL	PAREA1	5
296	578372.54	4140329.74	0.26132	15.51	15.51	0	ANNUAL	PAREA1	5
297	578397.54	4140329.74	0.31722	15.69	15.69	0	ANNUAL	PAREA1	5
298	578422.54	4140329.74	0.38902	15.07	15.07	0	ANNUAL	PAREA1	5
299	578447.54	4140329.74	0.48382	15.15	15.15	0	ANNUAL	PAREA1	5
300	578472.54	4140329.74	0.60855	14.78	14.78	0	ANNUAL	PAREA1	5
301	578497.54	4140329.74	0.77476	14.46	14.46	0	ANNUAL	PAREA1	5
302	578522.54	4140329.74	1.00093	15.09	15.09	0	ANNUAL	PAREA1	5
303	578547.54	4140329.74	1.29868	15.12	15.12	0	ANNUAL	PAREA1	5
304	578572.54	4140329.74	1.683	15.1	15.1	0	ANNUAL	PAREA1	5
305	578597.54	4140329.74	2.14557	14.82	14.82	0	ANNUAL	PAREA1	5
306	578622.54	4140329.74	2.64221	15.08	15.08	0	ANNUAL	PAREA1	5
307	578647.54	4140329.74	3.02324	15.28	15.28	0	ANNUAL	PAREA1	5
308	578672.54	4140329.74	3.0643	15.11	15.11	0	ANNUAL	PAREA1	5
309	578697.54	4140329.74	2.66773	14.93	14.93	0	ANNUAL	PAREA1	5
310	578747.54	4140329.74	1.46365	14.64	14.64	0	ANNUAL	PAREA1	5
311	578772.54	4140329.74	1.08904	14.88	14.88	0	ANNUAL	PAREA1	5
312	578797.54	4140329.74	0.87765	14.79	14.79	0	ANNUAL	PAREA1	5
313	578822.54	4140329.74	0.75684	14.6	14.6	0	ANNUAL	PAREA1	5
314	578847.54	4140329.74	0.67467	15.11	15.11	0	ANNUAL	PAREA1	5
315	578872.54	4140329.74	0.60467	15.21	15.21	0	ANNUAL	PAREA1	5
316	578897.54	4140329.74	0.54217	15.17	15.17	0	ANNUAL	PAREA1	5
317	578922.54	4140329.74	0.48604	14.85	14.85	0	ANNUAL	PAREA1	5
318	578947.54	4140329.74	0.43673	14.97	14.97	0	ANNUAL	PAREA1	5
319	578972.54	4140329.74	0.39314	15.29	15.29	0	ANNUAL	PAREA1	5
320	578997.54	4140329.74	0.35412	14.99	14.99	0	ANNUAL	PAREA1	5
321	578372.54	4140354.74	0.2929	15.59	15.59	0	ANNUAL	PAREA1	5
322	578397.54	4140354.74	0.3532	15.5	15.5	0	ANNUAL	PAREA1	5
323	578422.54	4140354.74	0.42944	15.03	15.03	0	ANNUAL	PAREA1	5
324	578447.54	4140354.74	0.52732	15.02	15.02	0	ANNUAL	PAREA1	5
325	578472.54	4140354.74	0.65241	14.88	14.88	0	ANNUAL	PAREA1	5
326	578497.54	4140354.74	0.81123	14.53	14.53	0	ANNUAL	PAREA1	5
327	578522.54	4140354.74	1.01344	14.73	14.73	0	ANNUAL	PAREA1	5
328	578547.54	4140354.74	1.26132	14.86	14.86	0	ANNUAL	PAREA1	5
329	578572.54	4140354.74	1.54586	14.53	14.53	0	ANNUAL	PAREA1	5
330	578597.54	4140354.74	1.84826	14.78	14.78	0	ANNUAL	PAREA1	5
331	578622.54	4140354.74	2.10695	15.18	15.18	0	ANNUAL	PAREA1	5
332	578647.54	4140354.74	2.22292	15.18	15.18	0	ANNUAL	PAREA1	5
333	578672.54	4140354.74	2.11483	15.02	15.02	0	ANNUAL	PAREA1	5
334	578697.54	4140354.74	1.79354	14.85	14.85	0	ANNUAL	PAREA1	5
335	578772.54	4140354.74	0.79074	14.79	14.79	0	ANNUAL	PAREA1	5
336	578797.54	4140354.74	0.64997	15.04	15.04	0	ANNUAL	PAREA1	5
337	578822.54	4140354.74	0.56737	15.12	15.12	0	ANNUAL	PAREA1	5
338	578847.54	4140354.74	0.51183	15.4	15.4	0	ANNUAL	PAREA1	5
339	578872.54	4140354.74	0.46621	15.14	15.14	0	ANNUAL	PAREA1	5
340	578897.54	4140354.74	0.42603	15.08	15.08	0	ANNUAL	PAREA1	5
341	578922.54	4140354.74	0.38878	14.33	14.33	0	ANNUAL	PAREA1	5
342	578947.54	4140354.74	0.35605	14.64	14.64	0	ANNUAL	PAREA1	5
343	578972.54	4140354.74	0.326	14.73	14.73	0	ANNUAL	PAREA1	5
344	578997.54	4140354.74	0.29823	14.18	14.18	0	ANNUAL	PAREA1	5
345	578372.54	4140379.74	0.31968	15.23	15.23	0	ANNUAL	PAREA1	5
346	578397.54	4140379.74	0.38185	15.06	15.06	0	ANNUAL	PAREA1	5
347	578422.54	4140379.74	0.45913	15.05	15.05	0	ANNUAL	PAREA1	5
348	578447.54	4140379.74	0.55411	14.6	14.6	0	ANNUAL	PAREA1	5
349	578472.54	4140379.74	0.67181	14.61	14.61	0	ANNUAL	PAREA1	5
350	578497.54	4140379.74	0.81467	14.62	14.62	0	ANNUAL	PAREA1	5

351	578522.54	4140379.74	0.98169	14.2	14.2	0	ANNUAL	PAREA1	5
352	578547.54	4140379.74	1.17235	14.36	14.36	0	ANNUAL	PAREA1	5
353	578572.54	4140379.74	1.37009	14.47	14.47	0	ANNUAL	PAREA1	5
354	578597.54	4140379.74	1.54776	14.77	14.77	0	ANNUAL	PAREA1	5
355	578622.54	4140379.74	1.65964	15	15	0	ANNUAL	PAREA1	5
356	578647.54	4140379.74	1.65729	15.09	15.09	0	ANNUAL	PAREA1	5
357	578672.54	4140379.74	1.51376	14.58	14.58	0	ANNUAL	PAREA1	5
358	578697.54	4140379.74	1.2702	14.6	14.6	0	ANNUAL	PAREA1	5
359	578722.54	4140379.74	0.99629	14.55	14.55	0	ANNUAL	PAREA1	5
360	578797.54	4140379.74	0.50107	14.69	14.69	0	ANNUAL	PAREA1	5
361	578822.54	4140379.74	0.44104	14.89	14.89	0	ANNUAL	PAREA1	5
362	578847.54	4140379.74	0.401	15.14	15.14	0	ANNUAL	PAREA1	5
363	578872.54	4140379.74	0.36889	14.6	14.6	0	ANNUAL	PAREA1	5
364	578897.54	4140379.74	0.34131	14.52	14.52	0	ANNUAL	PAREA1	5
365	578922.54	4140379.74	0.31598	14.19	14.19	0	ANNUAL	PAREA1	5
366	578947.54	4140379.74	0.29293	14.1	14.1	0	ANNUAL	PAREA1	5
367	578972.54	4140379.74	0.27172	14.06	14.06	0	ANNUAL	PAREA1	5
368	578997.54	4140379.74	0.25218	14.14	14.14	0	ANNUAL	PAREA1	5
369	578372.54	4140404.74	0.34057	15.04	15.04	0	ANNUAL	PAREA1	5
370	578397.54	4140404.74	0.40235	15.08	15.08	0	ANNUAL	PAREA1	5
371	578422.54	4140404.74	0.47639	14.71	14.71	0	ANNUAL	PAREA1	5
372	578447.54	4140404.74	0.56541	14.7	14.7	0	ANNUAL	PAREA1	5
373	578472.54	4140404.74	0.66936	14.25	14.25	0	ANNUAL	PAREA1	5
374	578497.54	4140404.74	0.78887	13.95	13.95	0	ANNUAL	PAREA1	5
375	578522.54	4140404.74	0.92332	14.41	14.41	0	ANNUAL	PAREA1	5
376	578547.54	4140404.74	1.06123	14.61	14.61	0	ANNUAL	PAREA1	5
377	578572.54	4140404.74	1.1869	14.61	14.61	0	ANNUAL	PAREA1	5
378	578597.54	4140404.74	1.27649	14.37	14.37	0	ANNUAL	PAREA1	5
379	578622.54	4140404.74	1.30788	14.65	14.65	0	ANNUAL	PAREA1	5
380	578647.54	4140404.74	1.25531	14.52	14.52	0	ANNUAL	PAREA1	5
381	578672.54	4140404.74	1.12098	14.2	14.2	0	ANNUAL	PAREA1	5
382	578697.54	4140404.74	0.93901	14.56	14.56	0	ANNUAL	PAREA1	5
383	578847.54	4140404.74	0.32281	14.55	17.95	0	ANNUAL	PAREA1	5
384	578872.54	4140404.74	0.29885	13.81	20.21	0	ANNUAL	PAREA1	5
385	578897.54	4140404.74	0.27917	14.1	14.1	0	ANNUAL	PAREA1	5
386	578922.54	4140404.74	0.26156	14.83	14.83	0	ANNUAL	PAREA1	5
387	578947.54	4140404.74	0.24471	14.61	14.61	0	ANNUAL	PAREA1	5
388	578972.54	4140404.74	0.22891	14.03	14.03	0	ANNUAL	PAREA1	5
389	578997.54	4140404.74	0.21415	13.36	13.36	0	ANNUAL	PAREA1	5
390	578372.54	4140429.74	0.3548	14.89	14.89	0	ANNUAL	PAREA1	5
391	578397.54	4140429.74	0.41362	14.79	14.79	0	ANNUAL	PAREA1	5
392	578422.54	4140429.74	0.48221	14.55	14.55	0	ANNUAL	PAREA1	5
393	578447.54	4140429.74	0.56139	14.44	14.44	0	ANNUAL	PAREA1	5
394	578472.54	4140429.74	0.65041	14.29	14.29	0	ANNUAL	PAREA1	5
395	578497.54	4140429.74	0.74591	13.79	13.79	0	ANNUAL	PAREA1	5
396	578522.54	4140429.74	0.84632	14.17	14.17	0	ANNUAL	PAREA1	5
397	578547.54	4140429.74	0.93874	14.11	14.11	0	ANNUAL	PAREA1	5
398	578572.54	4140429.74	1.01325	14.49	14.49	0	ANNUAL	PAREA1	5
399	578597.54	4140429.74	1.05043	14.39	14.39	0	ANNUAL	PAREA1	5
400	578622.54	4140429.74	1.03874	14.44	14.44	0	ANNUAL	PAREA1	5
401	578647.54	4140429.74	0.97186	14.52	14.52	0	ANNUAL	PAREA1	5
402	578672.54	4140429.74	0.85765	14.59	14.59	0	ANNUAL	PAREA1	5
403	578697.54	4140429.74	0.71773	14.54	14.54	0	ANNUAL	PAREA1	5
404	578722.54	4140429.74	0.24762	13.65	20.97	0	ANNUAL	PAREA1	5
405	578897.54	4140429.74	0.23316	14.72	20.97	0	ANNUAL	PAREA1	5
406	578922.54	4140429.74	0.21957	14.86	14.86	0	ANNUAL	PAREA1	5
407	578947.54	4140429.74	0.20694	14.74	14.74	0	ANNUAL	PAREA1	5
408	578972.54	4140429.74	0.19456	13.22	14.71	0	ANNUAL	PAREA1	5
409	578372.54	4140454.74	0.36191	14.29	14.29	0	ANNUAL	PAREA1	5
410	578397.54	4140454.74	0.41613	14.25	14.25	0	ANNUAL	PAREA1	5
411	578422.54	4140454.74	0.47802	14.59	14.59	0	ANNUAL	PAREA1	5
412	578447.54	4140454.74	0.54529	14.04	14.04	0	ANNUAL	PAREA1	5
413	578472.54	4140454.74	0.61817	14.01	14.01	0	ANNUAL	PAREA1	5
414	578497.54	4140454.74	0.69164	13.63	13.63	0	ANNUAL	PAREA1	5
415	578522.54	4140454.74	0.76253	13.84	13.84	0	ANNUAL	PAREA1	5
416	578547.54	4140454.74	0.82135	13.99	13.99	0	ANNUAL	PAREA1	5
417	578572.54	4140454.74	0.85806	13.98	13.98	0	ANNUAL	PAREA1	5
418	578597.54	4140454.74	0.86358	13.94	13.94	0	ANNUAL	PAREA1	5
419	578622.54	4140454.74	0.8322	13.97	13.97	0	ANNUAL	PAREA1	5
420	578647.54	4140454.74	0.76599	14.48	14.48	0	ANNUAL	PAREA1	5
421	578672.54	4140454.74	0.67076	14.53	14.53	0	ANNUAL	PAREA1	5
422	578697.54	4140454.74	0.56299	14.2	14.2	0	ANNUAL	PAREA1	5
423	578722.54	4140454.74	0.46129	14.19	14.19	0	ANNUAL	PAREA1	5
424	578747.54	4140454.74	0.37712	14.45	14.45	0	ANNUAL	PAREA1	5
425	578772.54	4140454.74	0.31347	13.77	13.77	0	ANNUAL	PAREA1	5
426	578897.54	4140454.74	0.19694	13.57	20.97	0	ANNUAL	PAREA1	5
427	578922.54	4140454.74	0.18688	14.71	20.97	0	ANNUAL	PAREA1	5
428	578947.54	4140454.74	0.17658	13.27	20.97	0	ANNUAL	PAREA1	5
429	578547.54	4140479.74	0.71296	13.71	13.71	0	ANNUAL	PAREA1	5
430	578572.54	4140479.74	0.72577	13.65	13.65	0	ANNUAL	PAREA1	5
431	578597.54	4140479.74	0.71407	13.82	13.82	0	ANNUAL	PAREA1	5
432	578622.54	4140479.74	0.67513	13.84	13.84	0	ANNUAL	PAREA1	5
433	578647.54	4140479.74	0.61311	14.06	14.06	0	ANNUAL	PAREA1	5
434	578672.54	4140479.74	0.53529	14.22	14.22	0	ANNUAL	PAREA1	5
435	578697.54	4140479.74	0.45186	13.88	13.88	0	ANNUAL	PAREA1	5
436	578722.54	4140479.74	0.37451	13.55	13.55	0	ANNUAL	PAREA1	5
437	578747.54	4140479.74	0.31194	14.73	14.73	0	ANNUAL	PAREA1	5
438	578772.54	4140479.74	0.26291	14.05	14.05	0	ANNUAL	PAREA1	5
439	578547.54	4140504.74	0.61626	13.26	13.26	0	ANNUAL	PAREA1	5
440	578572.54	4140504.74	0.61573	13.84	13.84	0	ANNUAL	PAREA1	5
441	578597.54	4140504.74	0.59417	13.76	13.76	0	ANNUAL	PAREA1	5
442	578622.54	4140504.74	0.55389	13.74	13.74	0	ANNUAL	PAREA1	5
443	578647.54	4140504.74	0.49872	13.78	13.78	0	ANNUAL	PAREA1	5
444	578672.54	4140504.74	0.43531	14.03	14.03	0	ANNUAL	PAREA1	5
445	578697.54	4140504.74	0.37061	14.25	14.25	0	ANNUAL	PAREA1	5
446	578722.54	4140504.74	0.31076	13.86	13.86	0	ANNUAL	PAREA1	5
447	578747.54	4140504.74	0.26136	13.93	13.93	0	ANNUAL	PAREA1	5
448	578772.54	4140504.74	0.22342	14.06	14.06	0	ANNUAL	PAREA1	5
449	578729.86	4140254.76	11.08845	15.3	15.3	0	ANNUAL	PAREA1	5
450	578721.07	4140258.69	10.89543	15.17	15.17	0	ANNUAL	PAREA1	5
451	578715.45	4140261.12	10.82204	15.27	15.27	0	ANNUAL	PAREA1	5
452	578707.87	4140264.31	10.67657	15.26	15.26	0	ANNUAL	PAREA1	5
453	578737.07	4140251.11	11.25125	15.29	15.29	0	ANNUAL	PAREA1	5
454	578743.99	4140247.74	11.23334	15.38	15.38	0	ANNUAL	PAREA1	5
455	578752.23	4140244.47	10.64952	15.4	15.4	0	ANNUAL	PAREA1	5
456	578779.94	4140231.11	8.44402	15.37	15.37	0	ANNUAL	PAREA1	5
457	578792.09	4140225.66	7.62662	15.54	15.54	0	ANNUAL	PAREA1	5

117	578497.54	4140104.74	0.16973	17.09	17.09	0	ANNUAL	ROAD_CA	5
118	578522.54	4140104.74	0.23313	16.87	16.87	0	ANNUAL	ROAD_CA	5
119	578547.54	4140104.74	0.33134	17.32	17.32	0	ANNUAL	ROAD_CA	5
120	578572.54	4140104.74	0.50326	17.38	17.38	0	ANNUAL	ROAD_CA	5
121	578597.54	4140104.74	0.82418	17.05	17.05	0	ANNUAL	ROAD_CA	5
122	579022.54	4140104.74	0.97461	16.35	16.35	0	ANNUAL	ROAD_CA	5
123	579047.54	4140104.74	0.78725	16.53	16.53	0	ANNUAL	ROAD_CA	5
124	579072.54	4140104.74	0.65089	16.43	16.43	0	ANNUAL	ROAD_CA	5
125	579097.54	4140104.74	0.54688	16.61	16.61	0	ANNUAL	ROAD_CA	5
126	578372.54	4140129.74	0.05729	17.21	17.21	0	ANNUAL	ROAD_CA	5
127	578397.54	4140129.74	0.0674	17.16	17.16	0	ANNUAL	ROAD_CA	5
128	578422.54	4140129.74	0.08084	16.94	16.94	0	ANNUAL	ROAD_CA	5
129	578447.54	4140129.74	0.09847	17.09	17.09	0	ANNUAL	ROAD_CA	5
130	578472.54	4140129.74	0.12331	17.06	17.06	0	ANNUAL	ROAD_CA	5
131	578497.54	4140129.74	0.15982	16.9	16.9	0	ANNUAL	ROAD_CA	5
132	578522.54	4140129.74	0.21359	17.21	17.21	0	ANNUAL	ROAD_CA	5
133	578547.54	4140129.74	0.30171	17.32	17.32	0	ANNUAL	ROAD_CA	5
134	578572.54	4140129.74	0.45777	17.21	17.21	0	ANNUAL	ROAD_CA	5
135	578597.54	4140129.74	0.75789	16.94	16.94	0	ANNUAL	ROAD_CA	5
136	578972.54	4140129.74	1.45321	16.24	16.24	0	ANNUAL	ROAD_CA	5
137	578997.54	4140129.74	1.12134	16.28	16.28	0	ANNUAL	ROAD_CA	5
138	579022.54	4140129.74	0.89465	16.07	16.07	0	ANNUAL	ROAD_CA	5
139	579047.54	4140129.74	0.72919	16.19	16.19	0	ANNUAL	ROAD_CA	5
140	579072.54	4140129.74	0.60685	16.33	16.33	0	ANNUAL	ROAD_CA	5
141	579097.54	4140129.74	0.5135	16.62	16.62	0	ANNUAL	ROAD_CA	5
142	578372.54	4140154.74	0.06023	17.02	17.02	0	ANNUAL	ROAD_CA	5
143	578397.54	4140154.74	0.06983	17.31	17.31	0	ANNUAL	ROAD_CA	5
144	578422.54	4140154.74	0.0831	16.77	16.77	0	ANNUAL	ROAD_CA	5
145	578447.54	4140154.74	0.09989	16.8	16.8	0	ANNUAL	ROAD_CA	5
146	578472.54	4140154.74	0.1226	16.9	16.9	0	ANNUAL	ROAD_CA	5
147	578497.54	4140154.74	0.15531	16.82	16.82	0	ANNUAL	ROAD_CA	5
148	578522.54	4140154.74	0.20362	16.89	16.89	0	ANNUAL	ROAD_CA	5
149	578547.54	4140154.74	0.28067	16.95	16.95	0	ANNUAL	ROAD_CA	5
150	578572.54	4140154.74	0.41491	16.95	16.95	0	ANNUAL	ROAD_CA	5
151	578597.54	4140154.74	0.67737	16.79	16.79	0	ANNUAL	ROAD_CA	5
152	578947.54	4140154.74	1.73005	15.91	15.91	0	ANNUAL	ROAD_CA	5
153	578972.54	4140154.74	1.29718	16.29	16.29	0	ANNUAL	ROAD_CA	5
154	578997.54	4140154.74	1.01921	15.91	15.91	0	ANNUAL	ROAD_CA	5
155	579022.54	4140154.74	0.81923	16.23	16.23	0	ANNUAL	ROAD_CA	5
156	579047.54	4140154.74	0.67667	16.07	16.07	0	ANNUAL	ROAD_CA	5
157	579072.54	4140154.74	0.56792	16.4	16.4	0	ANNUAL	ROAD_CA	5
158	579097.54	4140154.74	0.48558	16.05	16.05	0	ANNUAL	ROAD_CA	5
159	578372.54	4140179.74	0.06607	17.25	17.25	0	ANNUAL	ROAD_CA	5
160	578397.54	4140179.74	0.07672	17.05	17.05	0	ANNUAL	ROAD_CA	5
161	578422.54	4140179.74	0.0905	16.66	16.66	0	ANNUAL	ROAD_CA	5
162	578447.54	4140179.74	0.10745	16.8	16.8	0	ANNUAL	ROAD_CA	5
163	578472.54	4140179.74	0.131	16.48	16.48	0	ANNUAL	ROAD_CA	5
164	578497.54	4140179.74	0.16289	16.39	16.39	0	ANNUAL	ROAD_CA	5
165	578522.54	4140179.74	0.20826	16.43	16.43	0	ANNUAL	ROAD_CA	5
166	578547.54	4140179.74	0.27778	16.46	16.46	0	ANNUAL	ROAD_CA	5
167	578572.54	4140179.74	0.39191	16.53	16.53	0	ANNUAL	ROAD_CA	5
168	578597.54	4140179.74	0.60614	16.74	16.74	0	ANNUAL	ROAD_CA	5
169	578622.54	4140179.74	1.11892	16.11	16.11	0	ANNUAL	ROAD_CA	5
170	578897.54	4140179.74	2.99086	15.86	15.86	0	ANNUAL	ROAD_CA	5
171	578922.54	4140179.74	2.06447	15.75	15.75	0	ANNUAL	ROAD_CA	5
172	578947.54	4140179.74	1.51647	15.17	15.17	0	ANNUAL	ROAD_CA	5
173	578972.54	4140179.74	1.16695	15.74	15.74	0	ANNUAL	ROAD_CA	5
174	578997.54	4140179.74	0.92821	15.76	15.76	0	ANNUAL	ROAD_CA	5
175	579022.54	4140179.74	0.75785	15.77	15.77	0	ANNUAL	ROAD_CA	5
176	579047.54	4140179.74	0.6316	15.68	15.68	0	ANNUAL	ROAD_CA	5
177	579072.54	4140179.74	0.53484	16.14	16.14	0	ANNUAL	ROAD_CA	5
178	579097.54	4140179.74	0.45986	15.89	15.89	0	ANNUAL	ROAD_CA	5
179	578372.54	4140204.74	0.07641	16.81	16.81	0	ANNUAL	ROAD_CA	5
180	578397.54	4140204.74	0.08911	16.53	16.53	0	ANNUAL	ROAD_CA	5
181	578422.54	4140204.74	0.10502	16.34	16.34	0	ANNUAL	ROAD_CA	5
182	578447.54	4140204.74	0.12504	16.32	16.32	0	ANNUAL	ROAD_CA	5
183	578472.54	4140204.74	0.14972	16.78	16.78	0	ANNUAL	ROAD_CA	5
184	578497.54	4140204.74	0.18617	16.33	16.33	0	ANNUAL	ROAD_CA	5
185	578522.54	4140204.74	0.23735	16.01	16.01	0	ANNUAL	ROAD_CA	5
186	578547.54	4140204.74	0.30641	16.32	16.32	0	ANNUAL	ROAD_CA	5
187	578572.54	4140204.74	0.42022	16.18	16.18	0	ANNUAL	ROAD_CA	5
188	578597.54	4140204.74	0.61949	16.03	16.03	0	ANNUAL	ROAD_CA	5
189	578847.54	4140204.74	6.33256	15.7	15.7	0	ANNUAL	ROAD_CA	5
190	578872.54	4140204.74	3.72929	15.74	15.74	0	ANNUAL	ROAD_CA	5
191	578897.54	4140204.74	2.48078	15.55	15.55	0	ANNUAL	ROAD_CA	5
192	578922.54	4140204.74	1.78028	15.44	15.44	0	ANNUAL	ROAD_CA	5
193	578947.54	4140204.74	1.34462	15.16	15.16	0	ANNUAL	ROAD_CA	5
194	578972.54	4140204.74	1.05436	14.84	14.84	0	ANNUAL	ROAD_CA	5
195	578997.54	4140204.74	0.85208	15.61	15.61	0	ANNUAL	ROAD_CA	5
196	579022.54	4140204.74	0.70331	15.85	15.85	0	ANNUAL	ROAD_CA	5
197	579047.54	4140204.74	0.59109	15.82	15.82	0	ANNUAL	ROAD_CA	5
198	579072.54	4140204.74	0.50926	15.67	15.67	0	ANNUAL	ROAD_CA	5
199	579097.54	4140204.74	0.43555	15.91	15.91	0	ANNUAL	ROAD_CA	5
200	578372.54	4140229.74	0.09141	16.38	16.38	0	ANNUAL	ROAD_CA	5
201	578397.54	4140229.74	0.10749	16.16	16.16	0	ANNUAL	ROAD_CA	5
202	578422.54	4140229.74	0.12735	16.18	16.18	0	ANNUAL	ROAD_CA	5
203	578447.54	4140229.74	0.15254	16.32	16.32	0	ANNUAL	ROAD_CA	5
204	578472.54	4140229.74	0.18784	15.95	15.95	0	ANNUAL	ROAD_CA	5
205	578497.54	4140229.74	0.23387	15.84	15.84	0	ANNUAL	ROAD_CA	5
206	578522.54	4140229.74	0.29697	16.07	16.07	0	ANNUAL	ROAD_CA	5
207	578547.54	4140229.74	0.39134	15.82	15.82	0	ANNUAL	ROAD_CA	5
208	578572.54	4140229.74	0.53373	15.84	15.84	0	ANNUAL	ROAD_CA	5
209	578769.08	4140237.32	55.92504	15.45	15.45	0	ANNUAL	ROAD_CA	5
210	578797.54	4140229.74	19.50945	15.56	15.56	0	ANNUAL	ROAD_CA	5
211	578822.54	4140229.74	8.32829	15.55	15.55	0	ANNUAL	ROAD_CA	5
212	578847.54	4140229.74	4.65698	15.93	15.93	0	ANNUAL	ROAD_CA	5
213	578872.54	4140229.74	2.99531	15.95	15.95	0	ANNUAL	ROAD_CA	5
214	578897.54	4140229.74	2.09764	15.78	15.78	0	ANNUAL	ROAD_CA	5
215	578922.54	4140229.74	1.55498	15.36	15.36	0	ANNUAL	ROAD_CA	5
216	578947.54	4140229.74	1.20086	15.11	15.11	0	ANNUAL	ROAD_CA	5
217	578972.54	4140229.74	0.95735	15.14	15.14	0	ANNUAL	ROAD_CA	5
218	578997.54	4140229.74	0.7818	15	15	0	ANNUAL	ROAD_CA	5
219	579022.54	4140229.74	0.6516	15.43	15.43	0	ANNUAL	ROAD_CA	5
220	579047.54	4140229.74	0.55158	15.72	15.72	0	ANNUAL	ROAD_CA	5
221	579072.54	4140229.74	0.47324	15.38	15.38	0	ANNUAL	ROAD_CA	5
222	579097.54	4140229.74	0.41077	15.53	15.53	0	ANNUAL	ROAD_CA	5
223	578372.54	4140254.74	0.11117	16.13	16.13	0	ANNUAL	ROAD_CA	5
224	578397.54	4140254.74	0.13195	16.03	16.03	0	ANNUAL	ROAD_CA	5
225	578422.54	4140254.74	0.15815	16.1	16.1	0	ANNUAL	ROAD_CA	5
226	578447.54	4140254.74	0.1934	15.7	15.7	0	ANNUAL	ROAD_CA	5
227	578472.54	4140254.74	0.24006	15.7	15.7	0	ANNUAL	ROAD_CA	5
228	578497.54	4140254.74	0.30456	15.57	15.57	0	ANNUAL	ROAD_CA	5
229	578522.54	4140254.74	0.3969	15.66	15.66	0	ANNUAL	ROAD_CA	5
230	578547.54	4140254.74	0.535	15.7	15.7	0	ANNUAL	ROAD_CA	5
231	578747.54	4140254.74	40.0697	15.36	15.36	0	ANNUAL	ROAD_CA	5
232	578772.54	4140254.74	17.42751	15.31	15.31	0	ANNUAL	ROAD_CA	5
233	578797.54	4140254.74	8.90793	15.06	15.06	0	ANNUAL	ROAD_CA	5

234	578822.54	4140254.74	5.37638	15.48	15.48	0	ANNUAL	ROAD_CA	5
235	578847.54	4140254.74	3.46426	15.88	15.88	0	ANNUAL	ROAD_CA	5
236	578872.54	4140254.74	2.40008	15.71	15.71	0	ANNUAL	ROAD_CA	5
237	578897.54	4140254.74	1.7581	15.73	15.73	0	ANNUAL	ROAD_CA	5
238	578922.54	4140254.74	1.3426	15.23	15.23	0	ANNUAL	ROAD_CA	5
239	578947.54	4140254.74	1.05926	15.01	15.01	0	ANNUAL	ROAD_CA	5
240	578972.54	4140254.74	0.85831	15.27	15.27	0	ANNUAL	ROAD_CA	5
241	578997.54	4140254.74	0.70936	14.96	14.96	0	ANNUAL	ROAD_CA	5
242	579022.54	4140254.74	0.59684	15.17	15.17	0	ANNUAL	ROAD_CA	5
243	579047.54	4140254.74	0.50925	15.18	15.18	0	ANNUAL	ROAD_CA	5
244	579072.54	4140254.74	0.43994	15.46	15.46	0	ANNUAL	ROAD_CA	5
245	579097.54	4140254.74	0.3837	14.8	14.8	0	ANNUAL	ROAD_CA	5
246	578372.54	4140279.74	0.13587	15.92	15.92	0	ANNUAL	ROAD_CA	5
247	578397.54	4140279.74	0.16268	15.95	15.95	0	ANNUAL	ROAD_CA	5
248	578422.54	4140279.74	0.19761	15.94	15.94	0	ANNUAL	ROAD_CA	5
249	578447.54	4140279.74	0.24417	15.48	15.48	0	ANNUAL	ROAD_CA	5
250	578472.54	4140279.74	0.30777	15.4	15.4	0	ANNUAL	ROAD_CA	5
251	578497.54	4140279.74	0.38726	15.19	15.19	0	ANNUAL	ROAD_CA	5
252	578522.54	4140279.74	0.52828	15.26	15.26	0	ANNUAL	ROAD_CA	5
253	578547.54	4140279.74	0.72876	15.33	15.33	0	ANNUAL	ROAD_CA	5
254	578572.54	4140279.74	18.81279	15.16	15.16	0	ANNUAL	ROAD_CA	5
255	578597.54	4140279.74	12.34746	15.26	15.26	0	ANNUAL	ROAD_CA	5
256	578722.54	4140279.74	6.9992	15.15	15.15	0	ANNUAL	ROAD_CA	5
257	578747.54	4140279.74	4.5089	15.19	15.19	0	ANNUAL	ROAD_CA	5
258	578822.54	4140279.74	3.25575	15.14	15.14	0	ANNUAL	ROAD_CA	5
259	578847.54	4140279.74	2.40061	14.92	14.92	0	ANNUAL	ROAD_CA	5
260	578872.54	4140279.74	1.81643	15.3	15.3	0	ANNUAL	ROAD_CA	5
261	578897.54	4140279.74	1.40661	14.98	14.98	0	ANNUAL	ROAD_CA	5
262	578922.54	4140279.74	1.11699	14.82	14.82	0	ANNUAL	ROAD_CA	5
263	578947.54	4140279.74	0.90692	14.88	14.88	0	ANNUAL	ROAD_CA	5
264	578972.54	4140279.74	0.75066	15.41	15.41	0	ANNUAL	ROAD_CA	5
265	578997.54	4140279.74	0.63073	15.76	15.76	0	ANNUAL	ROAD_CA	5
266	579022.54	4140279.74	0.53724	15.4	15.4	0	ANNUAL	ROAD_CA	5
267	579047.54	4140279.74	0.4627	14.67	14.67	0	ANNUAL	ROAD_CA	5
268	579072.54	4140279.74	0.4032	14.97	14.97	0	ANNUAL	ROAD_CA	5
269	579097.54	4140279.74	0.35435	14.76	14.76	0	ANNUAL	ROAD_CA	5
270	578372.54	4140304.74	0.16451	15.89	15.89	0	ANNUAL	ROAD_CA	5
271	578397.54	4140304.74	0.19863	15.53	15.53	0	ANNUAL	ROAD_CA	5
272	578422.54	4140304.74	0.24338	15.47	15.47	0	ANNUAL	ROAD_CA	5
273	578447.54	4140304.74	0.3034	15.33	15.33	0	ANNUAL	ROAD_CA	5
274	578472.54	4140304.74	0.38585	15.12	15.12	0	ANNUAL	ROAD_CA	5
275	578497.54	4140304.74	0.50255	15.01	15.01	0	ANNUAL	ROAD_CA	5
276	578522.54	4140304.74	0.67303	14.89	14.89	0	ANNUAL	ROAD_CA	5
277	578547.54	4140304.74	0.93256	15.04	15.04	0	ANNUAL	ROAD_CA	5
278	578572.54	4140304.74	1.3433	15.13	15.13	0	ANNUAL	ROAD_CA	5
279	578647.54	4140304.74	5.20807	15.1	15.1	0	ANNUAL	ROAD_CA	5
280	578672.54	4140304.74	8.22551	15.44	15.44	0	ANNUAL	ROAD_CA	5
281	578747.54	4140304.74	5.44832	15.24	15.24	0	ANNUAL	ROAD_CA	5
282	578772.54	4140304.74	3.47504	14.94	14.94	0	ANNUAL	ROAD_CA	5
283	578797.54	4140304.74	2.50406	14.95	14.95	0	ANNUAL	ROAD_CA	5
284	578822.54	4140304.74	1.9901	14.88	14.88	0	ANNUAL	ROAD_CA	5
285	578847.54	4140304.74	1.61605	15.04	15.04	0	ANNUAL	ROAD_CA	5
286	578872.54	4140304.74	1.31425	14.63	14.63	0	ANNUAL	ROAD_CA	5
287	578897.54	4140304.74	1.07739	14.14	14.14	0	ANNUAL	ROAD_CA	5
288	578922.54	4140304.74	0.89532	14.38	14.38	0	ANNUAL	ROAD_CA	5
289	578947.54	4140304.74	0.75263	14.99	14.99	0	ANNUAL	ROAD_CA	5
290	578972.54	4140304.74	0.63897	15.52	15.52	0	ANNUAL	ROAD_CA	5
291	578997.54	4140304.74	0.5477	15.88	15.88	0	ANNUAL	ROAD_CA	5
292	579022.54	4140304.74	0.47396	15.25	15.25	0	ANNUAL	ROAD_CA	5
293	579047.54	4140304.74	0.41333	14.27	14.27	0	ANNUAL	ROAD_CA	5
294	579072.54	4140304.74	0.36387	14.15	14.15	0	ANNUAL	ROAD_CA	5
295	579097.54	4140304.74	0.32281	14.29	14.29	0	ANNUAL	ROAD_CA	5
296	578372.54	4140329.74	0.19631	15.51	15.51	0	ANNUAL	ROAD_CA	5
297	578397.54	4140329.74	0.23806	15.69	15.69	0	ANNUAL	ROAD_CA	5
298	578422.54	4140329.74	0.29268	15.07	15.07	0	ANNUAL	ROAD_CA	5
299	578447.54	4140329.74	0.36603	15.15	15.15	0	ANNUAL	ROAD_CA	5
300	578472.54	4140329.74	0.46573	14.78	14.78	0	ANNUAL	ROAD_CA	5
301	578497.54	4140329.74	0.60478	14.46	14.46	0	ANNUAL	ROAD_CA	5
302	578522.54	4140329.74	0.80561	15.09	15.09	0	ANNUAL	ROAD_CA	5
303	578547.54	4140329.74	1.09795	15.12	15.12	0	ANNUAL	ROAD_CA	5
304	578572.54	4140329.74	1.53273	15.1	15.1	0	ANNUAL	ROAD_CA	5
305	578597.54	4140329.74	2.18019	14.82	14.82	0	ANNUAL	ROAD_CA	5
306	578622.54	4140329.74	3.1299	15.08	15.08	0	ANNUAL	ROAD_CA	5
307	578647.54	4140329.74	4.36647	15.28	15.28	0	ANNUAL	ROAD_CA	5
308	578672.54	4140329.74	5.48203	15.11	15.11	0	ANNUAL	ROAD_CA	5
309	578697.54	4140329.74	5.56464	14.93	14.93	0	ANNUAL	ROAD_CA	5
310	578747.54	4140329.74	2.98091	14.64	14.64	0	ANNUAL	ROAD_CA	5
311	578772.54	4140329.74	2.03529	14.88	14.88	0	ANNUAL	ROAD_CA	5
312	578797.54	4140329.74	1.54559	14.79	14.79	0	ANNUAL	ROAD_CA	5
313	578822.54	4140329.74	1.28618	14.6	14.6	0	ANNUAL	ROAD_CA	5
314	578847.54	4140329.74	1.10521	15.11	15.11	0	ANNUAL	ROAD_CA	5
315	578872.54	4140329.74	0.9503	15.21	15.21	0	ANNUAL	ROAD_CA	5
316	578897.54	4140329.74	0.81746	15.17	15.17	0	ANNUAL	ROAD_CA	5
317	578922.54	4140329.74	0.70484	14.85	14.85	0	ANNUAL	ROAD_CA	5
318	578947.54	4140329.74	0.6111	14.97	14.97	0	ANNUAL	ROAD_CA	5
319	578972.54	4140329.74	0.53264	15.29	15.29	0	ANNUAL	ROAD_CA	5
320	578997.54	4140329.74	0.4664	14.99	14.99	0	ANNUAL	ROAD_CA	5
321	578372.54	4140354.74	0.22939	15.59	15.59	0	ANNUAL	ROAD_CA	5
322	578397.54	4140354.74	0.2783	15.5	15.5	0	ANNUAL	ROAD_CA	5
323	578422.54	4140354.74	0.34166	15.03	15.03	0	ANNUAL	ROAD_CA	5
324	578447.54	4140354.74	0.42563	15.02	15.02	0	ANNUAL	ROAD_CA	5
325	578472.54	4140354.74	0.538	14.88	14.88	0	ANNUAL	ROAD_CA	5
326	578497.54	4140354.74	0.69015	14.53	14.53	0	ANNUAL	ROAD_CA	5
327	578522.54	4140354.74	0.90035	14.73	14.73	0	ANNUAL	ROAD_CA	5
328	578547.54	4140354.74	1.19032	14.86	14.86	0	ANNUAL	ROAD_CA	5
329	578572.54	4140354.74	1.58368	14.53	14.53	0	ANNUAL	ROAD_CA	5
330	578597.54	4140354.74	2.10796	14.78	14.78	0	ANNUAL	ROAD_CA	5
331	578622.54	4140354.74	2.7447	15.18	15.18	0	ANNUAL	ROAD_CA	5
332	578647.54	4140354.74	3.3623	15.18	15.18	0	ANNUAL	ROAD_CA	5
333	578672.54	4140354.74	3.6761	15.02	15.02	0	ANNUAL	ROAD_CA	5
334	578697.54	4140354.74	3.40187	14.85	14.85	0	ANNUAL	ROAD_CA	5
335	578722.54	4140354.74	1.33554	14.79	14.79	0	ANNUAL	ROAD_CA	5
336	578747.54	4140354.74	1.04662	15.04	15.04	0	ANNUAL	ROAD_CA	5
337	578822.54	4140354.74	0.89102	15.12	15.12	0	ANNUAL	ROAD_CA	5
338	578847.54	4140354.74	0.78665	15.4	15.4	0	ANNUAL	ROAD_CA	5
339	578872.54	4140354.74	0.69881	15.14	15.14	0	ANNUAL	ROAD_CA	5
340	578897.54	4140354.74	0.62131	15.08	15.08	0	ANNUAL	ROAD_CA	5
341	578922.54	4140354.74	0.55165	14.33	14.33	0	ANNUAL	ROAD_CA	5
342	578947.54	4140354.74	0.49176	14.64	14.64	0	ANNUAL	ROAD_CA	5
343	578972.54	4140354.74	0.43891	14.73	14.73	0	ANNUAL	ROAD_CA	5
344	578997.54	4140354.74	0.39214	14.18	14.18	0	ANNUAL	ROAD_CA	5
345	578372.54	4140379.74	0.26151	15.23	15.23	0	ANNUAL	ROAD_CA	5
346	578397.54	4140379.74	0.31596	15.06	15.06	0	ANNUAL	ROAD_CA	5
347	578422.54	4140379.74	0.38578	15.05	15.05	0	ANNUAL	ROAD_CA	5
348	578447.54	4140379.74	0.47578	14.6	14.6	0	ANNUAL	ROAD_CA	5
349	578472.54	4140379.74	0.5934	14.61	14.61	0	ANNUAL	ROAD_CA	5
350	578497.54	4140379.74	0.74746	14.62	14.62	0	ANNUAL	ROAD_CA	5

351	578522.54	4140379.74	0.94679	14.2	14.2	0	ANNUAL	ROAD_CA	5
352	578547.54	4140379.74	1.20515	14.36	14.36	0	ANNUAL	ROAD_CA	5
353	578572.54	4140379.74	1.52591	14.47	14.47	0	ANNUAL	ROAD_CA	5
354	578597.54	4140379.74	1.89805	14.77	14.77	0	ANNUAL	ROAD_CA	5
355	578622.54	4140379.74	2.26857	15	15	0	ANNUAL	ROAD_CA	5
356	578647.54	4140379.74	2.52862	15.09	15.09	0	ANNUAL	ROAD_CA	5
357	578672.54	4140379.74	2.5316	14.58	14.58	0	ANNUAL	ROAD_CA	5
358	578697.54	4140379.74	2.23253	14.6	14.6	0	ANNUAL	ROAD_CA	5
359	578722.54	4140379.74	1.74262	14.55	14.55	0	ANNUAL	ROAD_CA	5
360	578797.54	4140379.74	0.75577	14.69	14.69	0	ANNUAL	ROAD_CA	5
361	578822.54	4140379.74	0.65154	14.89	14.89	0	ANNUAL	ROAD_CA	5
362	578847.54	4140379.74	0.58384	15.14	15.14	0	ANNUAL	ROAD_CA	5
363	578872.54	4140379.74	0.52871	14.6	14.6	0	ANNUAL	ROAD_CA	5
364	578897.54	4140379.74	0.48039	14.52	14.52	0	ANNUAL	ROAD_CA	5
365	578922.54	4140379.74	0.43634	14.19	14.19	0	ANNUAL	ROAD_CA	5
366	578947.54	4140379.74	0.38675	14.1	14.1	0	ANNUAL	ROAD_CA	5
367	578972.54	4140379.74	0.36097	14.06	14.06	0	ANNUAL	ROAD_CA	5
368	578997.54	4140379.74	0.32873	14.14	14.14	0	ANNUAL	ROAD_CA	5
369	578372.54	4140404.74	0.29058	15.04	15.04	0	ANNUAL	ROAD_CA	5
370	578397.54	4140404.74	0.34865	15.08	15.08	0	ANNUAL	ROAD_CA	5
371	578422.54	4140404.74	0.42126	14.71	14.71	0	ANNUAL	ROAD_CA	5
372	578447.54	4140404.74	0.51305	14.7	14.7	0	ANNUAL	ROAD_CA	5
373	578472.54	4140404.74	0.62786	14.25	14.25	0	ANNUAL	ROAD_CA	5
374	578497.54	4140404.74	0.77139	13.95	13.95	0	ANNUAL	ROAD_CA	5
375	578522.54	4140404.74	0.95027	14.41	14.41	0	ANNUAL	ROAD_CA	5
376	578547.54	4140404.74	1.16255	14.61	14.61	0	ANNUAL	ROAD_CA	5
377	578572.54	4140404.74	1.39951	14.61	14.61	0	ANNUAL	ROAD_CA	5
378	578597.54	4140404.74	1.63478	14.37	14.37	0	ANNUAL	ROAD_CA	5
379	578622.54	4140404.74	1.82566	14.65	14.65	0	ANNUAL	ROAD_CA	5
380	578647.54	4140404.74	1.89874	14.52	14.52	0	ANNUAL	ROAD_CA	5
381	578672.54	4140404.74	1.80144	14.2	14.2	0	ANNUAL	ROAD_CA	5
382	578697.54	4140404.74	1.55021	14.56	14.56	0	ANNUAL	ROAD_CA	5
383	578847.54	4140404.74	0.44996	14.55	17.95	0	ANNUAL	ROAD_CA	5
384	578872.54	4140404.74	0.41204	13.81	20.21	0	ANNUAL	ROAD_CA	5
385	578897.54	4140404.74	0.38018	14.1	14.1	0	ANNUAL	ROAD_CA	5
386	578922.54	4140404.74	0.35132	14.83	14.83	0	ANNUAL	ROAD_CA	5
387	578947.54	4140404.74	0.32415	14.61	14.61	0	ANNUAL	ROAD_CA	5
388	578972.54	4140404.74	0.29892	14.03	14.03	0	ANNUAL	ROAD_CA	5
389	578997.54	4140404.74	0.27568	13.36	13.36	0	ANNUAL	ROAD_CA	5
390	578372.54	4140429.74	0.3149	14.89	14.89	0	ANNUAL	ROAD_CA	5
391	578397.54	4140429.74	0.37401	14.79	14.79	0	ANNUAL	ROAD_CA	5
392	578422.54	4140429.74	0.44634	14.55	14.55	0	ANNUAL	ROAD_CA	5
393	578447.54	4140429.74	0.5348	14.44	14.44	0	ANNUAL	ROAD_CA	5
394	578472.54	4140429.74	0.64176	14.29	14.29	0	ANNUAL	ROAD_CA	5
395	578497.54	4140429.74	0.76796	13.79	13.79	0	ANNUAL	ROAD_CA	5
396	578522.54	4140429.74	0.9162	14.17	14.17	0	ANNUAL	ROAD_CA	5
397	578547.54	4140429.74	1.07726	14.11	14.11	0	ANNUAL	ROAD_CA	5
398	578572.54	4140429.74	1.24069	14.49	14.49	0	ANNUAL	ROAD_CA	5
399	578597.54	4140429.74	1.37785	14.39	14.39	0	ANNUAL	ROAD_CA	5
400	578622.54	4140429.74	1.45746	14.44	14.44	0	ANNUAL	ROAD_CA	5
401	578647.54	4140429.74	1.44516	14.52	14.52	0	ANNUAL	ROAD_CA	5
402	578672.54	4140429.74	1.32669	14.59	14.59	0	ANNUAL	ROAD_CA	5
403	578697.54	4140429.74	1.12431	14.54	14.54	0	ANNUAL	ROAD_CA	5
404	578722.54	4140429.74	0.33059	13.65	20.97	0	ANNUAL	ROAD_CA	5
405	578897.54	4140429.74	0.30844	14.72	20.97	0	ANNUAL	ROAD_CA	5
406	578922.54	4140429.74	0.28759	14.86	14.86	0	ANNUAL	ROAD_CA	5
407	578947.54	4140429.74	0.26821	14.74	14.74	0	ANNUAL	ROAD_CA	5
408	578972.54	4140429.74	0.24954	13.22	14.71	0	ANNUAL	ROAD_CA	5
409	578372.54	4140454.74	0.33303	14.29	14.29	0	ANNUAL	ROAD_CA	5
410	578397.54	4140454.74	0.39097	14.25	14.25	0	ANNUAL	ROAD_CA	5
411	578422.54	4140454.74	0.46055	14.59	14.59	0	ANNUAL	ROAD_CA	5
412	578447.54	4140454.74	0.5415	14.04	14.04	0	ANNUAL	ROAD_CA	5
413	578472.54	4140454.74	0.63612	14.01	14.01	0	ANNUAL	ROAD_CA	5
414	578497.54	4140454.74	0.74204	13.63	13.63	0	ANNUAL	ROAD_CA	5
415	578522.54	4140454.74	0.8578	13.84	13.84	0	ANNUAL	ROAD_CA	5
416	578547.54	4140454.74	0.97389	13.99	13.99	0	ANNUAL	ROAD_CA	5
417	578572.54	4140454.74	1.07605	13.98	13.98	0	ANNUAL	ROAD_CA	5
418	578597.54	4140454.74	1.14575	13.94	13.94	0	ANNUAL	ROAD_CA	5
419	578622.54	4140454.74	1.16296	13.97	13.97	0	ANNUAL	ROAD_CA	5
420	578647.54	4140454.74	1.11573	14.48	14.48	0	ANNUAL	ROAD_CA	5
421	578672.54	4140454.74	1.00161	14.53	14.53	0	ANNUAL	ROAD_CA	5
422	578697.54	4140454.74	0.84369	14.2	14.2	0	ANNUAL	ROAD_CA	5
423	578722.54	4140454.74	0.67912	14.19	14.19	0	ANNUAL	ROAD_CA	5
424	578747.54	4140454.74	0.53756	14.45	14.45	0	ANNUAL	ROAD_CA	5
425	578772.54	4140454.74	0.43148	13.77	13.77	0	ANNUAL	ROAD_CA	5
426	578897.54	4140454.74	0.25426	13.57	20.97	0	ANNUAL	ROAD_CA	5
427	578922.54	4140454.74	0.23939	14.71	20.97	0	ANNUAL	ROAD_CA	5
428	578947.54	4140454.74	0.22445	13.27	20.97	0	ANNUAL	ROAD_CA	5
429	578547.54	4140479.74	0.8645	13.71	13.71	0	ANNUAL	ROAD_CA	5
430	578572.54	4140479.74	0.92285	13.65	13.65	0	ANNUAL	ROAD_CA	5
431	578597.54	4140479.74	0.95016	13.82	13.82	0	ANNUAL	ROAD_CA	5
432	578622.54	4140479.74	0.93456	13.84	13.84	0	ANNUAL	ROAD_CA	5
433	578647.54	4140479.74	0.87376	14.06	14.06	0	ANNUAL	ROAD_CA	5
434	578672.54	4140479.74	0.77414	14.22	14.22	0	ANNUAL	ROAD_CA	5
435	578697.54	4140479.74	0.65208	13.88	13.88	0	ANNUAL	ROAD_CA	5
436	578722.54	4140479.74	0.53082	13.55	13.55	0	ANNUAL	ROAD_CA	5
437	578747.54	4140479.74	0.42978	14.73	14.73	0	ANNUAL	ROAD_CA	5
438	578772.54	4140479.74	0.35162	14.05	14.05	0	ANNUAL	ROAD_CA	5
439	578547.54	4140504.74	0.75821	13.26	13.26	0	ANNUAL	ROAD_CA	5
440	578572.54	4140504.74	0.78813	13.84	13.84	0	ANNUAL	ROAD_CA	5
441	578597.54	4140504.74	0.78856	13.76	13.76	0	ANNUAL	ROAD_CA	5
442	578622.54	4140504.74	0.75721	13.74	13.74	0	ANNUAL	ROAD_CA	5
443	578647.54	4140504.74	0.69546	13.78	13.78	0	ANNUAL	ROAD_CA	5
444	578672.54	4140504.74	0.61163	14.03	14.03	0	ANNUAL	ROAD_CA	5
445	578697.54	4140504.74	0.51778	14.25	14.25	0	ANNUAL	ROAD_CA	5
446	578722.54	4140504.74	0.42667	13.86	13.86	0	ANNUAL	ROAD_CA	5
447	578747.54	4140504.74	0.35006	13.93	13.93	0	ANNUAL	ROAD_CA	5
448	578772.54	4140504.74	0.29164	14.06	14.06	0	ANNUAL	ROAD_CA	5
449	578729.86	4140254.76	66.21658	15.3	15.3	0	ANNUAL	ROAD_CA	5
450	578721.07	4140258.69	60.38985	15.17	15.17	0	ANNUAL	ROAD_CA	5
451	578715.45	4140261.11	56.24281	15.27	15.27	0	ANNUAL	ROAD_CA	5
452	578707.87	4140264.31	47.25874	15.26	15.26	0	ANNUAL	ROAD_CA	5
453	578737.07	4140251.11	70.77364	15.29	15.29	0	ANNUAL	ROAD_CA	5
454	578743.99	4140247.74	73.5886	15.38	15.38	0	ANNUAL	ROAD_CA	5
455	578752.23	4140244.47	69.51892	15.4	15.4	0	ANNUAL	ROAD_CA	5
456	578779.94	4140231.11	45.96207	15.37	15.37	0	ANNUAL	ROAD_CA	5
457	578792.09	4140225.66	29.79696	15.54	15.54	0	ANNUAL	ROAD_CA	5

117	578497.54	4140104.74	0.0606	17.09	17.09	0	ANNUAL	ROAD_SA	5
118	578522.54	4140104.74	0.07688	16.87	16.87	0	ANNUAL	ROAD_SA	5
119	578547.54	4140104.74	0.09981	17.32	17.32	0	ANNUAL	ROAD_SA	5
120	578572.54	4140104.74	0.13498	17.38	17.38	0	ANNUAL	ROAD_SA	5
121	578597.54	4140104.74	0.1914	17.05	17.05	0	ANNUAL	ROAD_SA	5
122	579022.54	4140104.74	0.74278	16.35	16.35	0	ANNUAL	ROAD_SA	5
123	579047.54	4140104.74	0.71102	16.53	16.53	0	ANNUAL	ROAD_SA	5
124	579072.54	4140104.74	0.68074	16.43	16.43	0	ANNUAL	ROAD_SA	5
125	579097.54	4140104.74	0.65026	16.61	16.61	0	ANNUAL	ROAD_SA	5
126	578372.54	4140129.74	0.02526	17.21	17.21	0	ANNUAL	ROAD_SA	5
127	578397.54	4140129.74	0.0289	17.16	17.16	0	ANNUAL	ROAD_SA	5
128	578422.54	4140129.74	0.03352	16.94	16.94	0	ANNUAL	ROAD_SA	5
129	578447.54	4140129.74	0.03938	17.09	17.09	0	ANNUAL	ROAD_SA	5
130	578472.54	4140129.74	0.04725	17.06	17.06	0	ANNUAL	ROAD_SA	5
131	578497.54	4140129.74	0.05819	16.9	16.9	0	ANNUAL	ROAD_SA	5
132	578522.54	4140129.74	0.07348	17.21	17.21	0	ANNUAL	ROAD_SA	5
133	578547.54	4140129.74	0.08653	17.32	17.32	0	ANNUAL	ROAD_SA	5
134	578572.54	4140129.74	0.1331	17.21	17.21	0	ANNUAL	ROAD_SA	5
135	578597.54	4140129.74	0.19429	16.94	16.94	0	ANNUAL	ROAD_SA	5
136	578972.54	4140129.74	0.86767	16.24	16.24	0	ANNUAL	ROAD_SA	5
137	578997.54	4140129.74	0.82839	16.28	16.28	0	ANNUAL	ROAD_SA	5
138	579022.54	4140129.74	0.79195	16.07	16.07	0	ANNUAL	ROAD_SA	5
139	579047.54	4140129.74	0.75565	16.19	16.19	0	ANNUAL	ROAD_SA	5
140	579072.54	4140129.74	0.72011	16.33	16.33	0	ANNUAL	ROAD_SA	5
141	579097.54	4140129.74	0.6851	16.62	16.62	0	ANNUAL	ROAD_SA	5
142	578372.54	4140154.74	0.02453	17.02	17.02	0	ANNUAL	ROAD_SA	5
143	578397.54	4140154.74	0.02792	17.31	17.31	0	ANNUAL	ROAD_SA	5
144	578422.54	4140154.74	0.03238	16.77	16.77	0	ANNUAL	ROAD_SA	5
145	578447.54	4140154.74	0.03795	16.8	16.8	0	ANNUAL	ROAD_SA	5
146	578472.54	4140154.74	0.0453	16.9	16.9	0	ANNUAL	ROAD_SA	5
147	578497.54	4140154.74	0.05554	16.82	16.82	0	ANNUAL	ROAD_SA	5
148	578522.54	4140154.74	0.0702	16.89	16.89	0	ANNUAL	ROAD_SA	5
149	578547.54	4140154.74	0.09251	16.95	16.95	0	ANNUAL	ROAD_SA	5
150	578572.54	4140154.74	0.12882	16.95	16.95	0	ANNUAL	ROAD_SA	5
151	578597.54	4140154.74	0.19285	16.79	16.79	0	ANNUAL	ROAD_SA	5
152	578947.54	4140154.74	0.98332	15.91	15.91	0	ANNUAL	ROAD_SA	5
153	578972.54	4140154.74	0.9323	16.29	16.29	0	ANNUAL	ROAD_SA	5
154	578997.54	4140154.74	0.88853	15.91	15.91	0	ANNUAL	ROAD_SA	5
155	579022.54	4140154.74	0.84453	16.23	16.23	0	ANNUAL	ROAD_SA	5
156	579047.54	4140154.74	0.80351	16.07	16.07	0	ANNUAL	ROAD_SA	5
157	579072.54	4140154.74	0.76226	16.4	16.4	0	ANNUAL	ROAD_SA	5
158	579097.54	4140154.74	0.72399	16.05	16.05	0	ANNUAL	ROAD_SA	5
159	578372.54	4140179.74	0.02383	17.25	17.25	0	ANNUAL	ROAD_SA	5
160	578397.54	4140179.74	0.02715	17.05	17.05	0	ANNUAL	ROAD_SA	5
161	578422.54	4140179.74	0.03136	16.66	16.66	0	ANNUAL	ROAD_SA	5
162	578447.54	4140179.74	0.03657	16.8	16.8	0	ANNUAL	ROAD_SA	5
163	578472.54	4140179.74	0.04362	16.48	16.48	0	ANNUAL	ROAD_SA	5
164	578497.54	4140179.74	0.05319	16.39	16.39	0	ANNUAL	ROAD_SA	5
165	578522.54	4140179.74	0.06687	16.43	16.43	0	ANNUAL	ROAD_SA	5
166	578547.54	4140179.74	0.08784	16.46	16.46	0	ANNUAL	ROAD_SA	5
167	578572.54	4140179.74	0.12218	16.53	16.53	0	ANNUAL	ROAD_SA	5
168	578597.54	4140179.74	0.18486	16.74	16.74	0	ANNUAL	ROAD_SA	5
169	578622.54	4140179.74	0.32281	16.11	16.11	0	ANNUAL	ROAD_SA	5
170	578897.54	4140179.74	1.2054	15.86	15.86	0	ANNUAL	ROAD_SA	5
171	578922.54	4140179.74	1.12912	15.75	15.75	0	ANNUAL	ROAD_SA	5
172	578947.54	4140179.74	1.06691	15.17	15.17	0	ANNUAL	ROAD_SA	5
173	578972.54	4140179.74	1.00732	15.74	15.74	0	ANNUAL	ROAD_SA	5
174	578997.54	4140179.74	0.95453	15.76	15.76	0	ANNUAL	ROAD_SA	5
175	579022.54	4140179.74	0.90446	15.77	15.77	0	ANNUAL	ROAD_SA	5
176	579047.54	4140179.74	0.85645	15.68	15.68	0	ANNUAL	ROAD_SA	5
177	579072.54	4140179.74	0.80904	16.14	16.14	0	ANNUAL	ROAD_SA	5
178	579097.54	4140179.74	0.76468	15.89	15.89	0	ANNUAL	ROAD_SA	5
179	578372.54	4140204.74	0.02346	16.81	16.81	0	ANNUAL	ROAD_SA	5
180	578397.54	4140204.74	0.02669	16.53	16.53	0	ANNUAL	ROAD_SA	5
181	578422.54	4140204.74	0.03068	16.34	16.34	0	ANNUAL	ROAD_SA	5
182	578447.54	4140204.74	0.03568	16.32	16.32	0	ANNUAL	ROAD_SA	5
183	578472.54	4140204.74	0.04197	16.78	16.78	0	ANNUAL	ROAD_SA	5
184	578497.54	4140204.74	0.051	16.33	16.33	0	ANNUAL	ROAD_SA	5
185	578522.54	4140204.74	0.06388	16.01	16.01	0	ANNUAL	ROAD_SA	5
186	578547.54	4140204.74	0.08258	16.32	16.32	0	ANNUAL	ROAD_SA	5
187	578572.54	4140204.74	0.1145	16.18	16.18	0	ANNUAL	ROAD_SA	5
188	578597.54	4140204.74	0.17466	16.03	16.03	0	ANNUAL	ROAD_SA	5
189	578847.54	4140204.74	1.57955	15.7	15.7	0	ANNUAL	ROAD_SA	5
190	578872.54	4140204.74	1.43182	15.74	15.74	0	ANNUAL	ROAD_SA	5
191	578897.54	4140204.74	1.32129	15.55	15.55	0	ANNUAL	ROAD_SA	5
192	578922.54	4140204.74	1.233	15.44	15.44	0	ANNUAL	ROAD_SA	5
193	578947.54	4140204.74	1.15891	15.16	15.16	0	ANNUAL	ROAD_SA	5
194	578972.54	4140204.74	1.09226	14.84	14.84	0	ANNUAL	ROAD_SA	5
195	578997.54	4140204.74	1.02855	15.61	15.61	0	ANNUAL	ROAD_SA	5
196	579022.54	4140204.74	0.96951	15.85	15.85	0	ANNUAL	ROAD_SA	5
197	579047.54	4140204.74	0.91353	15.82	15.82	0	ANNUAL	ROAD_SA	5
198	579072.54	4140204.74	0.86	15.67	15.67	0	ANNUAL	ROAD_SA	5
199	579097.54	4140204.74	0.80822	15.91	15.91	0	ANNUAL	ROAD_SA	5
200	578372.54	4140229.74	0.0234	16.38	16.38	0	ANNUAL	ROAD_SA	5
201	578397.54	4140229.74	0.02657	16.16	16.16	0	ANNUAL	ROAD_SA	5
202	578422.54	4140229.74	0.03041	16.18	16.18	0	ANNUAL	ROAD_SA	5
203	578447.54	4140229.74	0.03519	16.32	16.32	0	ANNUAL	ROAD_SA	5
204	578472.54	4140229.74	0.04162	15.95	15.95	0	ANNUAL	ROAD_SA	5
205	578497.54	4140229.74	0.05004	15.84	15.84	0	ANNUAL	ROAD_SA	5
206	578522.54	4140229.74	0.06163	16.07	16.07	0	ANNUAL	ROAD_SA	5
207	578547.54	4140229.74	0.07925	15.82	15.82	0	ANNUAL	ROAD_SA	5
208	578572.54	4140229.74	0.1075	15.84	15.84	0	ANNUAL	ROAD_SA	5
209	578769.08	4140237.32	3.20279	15.45	15.45	0	ANNUAL	ROAD_SA	5
210	578797.54	4140229.74	2.36874	15.56	15.56	0	ANNUAL	ROAD_SA	5
211	578822.54	4140229.74	2.0037	15.55	15.55	0	ANNUAL	ROAD_SA	5
212	578847.54	4140229.74	1.75653	15.93	15.93	0	ANNUAL	ROAD_SA	5
213	578872.54	4140229.74	1.58197	15.95	15.95	0	ANNUAL	ROAD_SA	5
214	578897.54	4140229.74	1.45313	15.78	15.78	0	ANNUAL	ROAD_SA	5
215	578922.54	4140229.74	1.35249	15.36	15.36	0	ANNUAL	ROAD_SA	5
216	578947.54	4140229.74	1.26507	15.11	15.11	0	ANNUAL	ROAD_SA	5
217	578972.54	4140229.74	1.18579	15.14	15.14	0	ANNUAL	ROAD_SA	5
218	578997.54	4140229.74	1.11277	15	15	0	ANNUAL	ROAD_SA	5
219	579022.54	4140229.74	1.04317	15.43	15.43	0	ANNUAL	ROAD_SA	5
220	579047.54	4140229.74	0.97697	15.72	15.72	0	ANNUAL	ROAD_SA	5
221	579072.54	4140229.74	0.91514	15.38	15.38	0	ANNUAL	ROAD_SA	5
222	579097.54	4140229.74	0.85593	15.53	15.53	0	ANNUAL	ROAD_SA	5
223	578372.54	4140254.74	0.02374	16.13	16.13	0	ANNUAL	ROAD_SA	5
224	578397.54	4140254.74	0.02691	16.03	16.03	0	ANNUAL	ROAD_SA	5
225	578422.54	4140254.74	0.03078	16.1	16.1	0	ANNUAL	ROAD_SA	5
226	578447.54	4140254.74	0.03579	15.7	15.7	0	ANNUAL	ROAD_SA	5
227	578472.54	4140254.74	0.04211	15.7	15.7	0	ANNUAL	ROAD_SA	5
228	578497.54	4140254.74	0.05055	15.57	15.57	0	ANNUAL	ROAD_SA	5
229	578522.54	4140254.74	0.06215	15.66	15.66	0	ANNUAL	ROAD_SA	5
230	578547.54	4140254.74	0.07913	15.7	15.7	0	ANNUAL	ROAD_SA	5
231	578747.54	4140254.74	4.84937	15.36	15.36	0	ANNUAL	ROAD_SA	5
232	578772.54	4140254.74	3.47398	15.31	15.31	0	ANNUAL	ROAD_SA	5
233	578797.54	4140254.74	2.71684	15.06	15.06	0	ANNUAL	ROAD_SA	5

351	578522.54	4140379.74	0.11108	14.2	14.2	0	ANNUAL	ROAD_SA	5
352	578547.54	4140379.74	0.14562	14.36	14.36	0	ANNUAL	ROAD_SA	5
353	578572.54	4140379.74	0.19553	14.47	14.47	0	ANNUAL	ROAD_SA	5
354	578597.54	4140379.74	0.26824	14.77	14.77	0	ANNUAL	ROAD_SA	5
355	578622.54	4140379.74	0.37337	15	15	0	ANNUAL	ROAD_SA	5
356	578647.54	4140379.74	0.52508	15.09	15.09	0	ANNUAL	ROAD_SA	5
357	578672.54	4140379.74	0.75159	14.58	14.58	0	ANNUAL	ROAD_SA	5
358	578697.54	4140379.74	1.14078	14.6	14.6	0	ANNUAL	ROAD_SA	5
359	578722.54	4140379.74	1.94934	14.55	14.55	0	ANNUAL	ROAD_SA	5
360	578797.54	4140379.74	8.49204	14.69	14.69	0	ANNUAL	ROAD_SA	5
361	578822.54	4140379.74	6.15388	14.89	14.89	0	ANNUAL	ROAD_SA	5
362	578847.54	4140379.74	4.79854	15.14	15.14	0	ANNUAL	ROAD_SA	5
363	578872.54	4140379.74	3.89282	14.6	14.6	0	ANNUAL	ROAD_SA	5
364	578897.54	4140379.74	3.28309	14.52	14.52	0	ANNUAL	ROAD_SA	5
365	578922.54	4140379.74	2.83374	14.19	14.19	0	ANNUAL	ROAD_SA	5
366	578947.54	4140379.74	2.46279	14.1	14.1	0	ANNUAL	ROAD_SA	5
367	578972.54	4140379.74	2.19012	14.06	14.06	0	ANNUAL	ROAD_SA	5
368	578997.54	4140379.74	1.94061	14.14	14.14	0	ANNUAL	ROAD_SA	5
369	578372.54	4140404.74	0.03798	15.04	15.04	0	ANNUAL	ROAD_SA	5
370	578397.54	4140404.74	0.04443	15.08	15.08	0	ANNUAL	ROAD_SA	5
371	578422.54	4140404.74	0.05272	14.71	14.71	0	ANNUAL	ROAD_SA	5
372	578447.54	4140404.74	0.06345	14.7	14.7	0	ANNUAL	ROAD_SA	5
373	578472.54	4140404.74	0.07758	14.25	14.25	0	ANNUAL	ROAD_SA	5
374	578497.54	4140404.74	0.09646	13.95	13.95	0	ANNUAL	ROAD_SA	5
375	578522.54	4140404.74	0.1221	14.41	14.41	0	ANNUAL	ROAD_SA	5
376	578547.54	4140404.74	0.15712	14.61	14.61	0	ANNUAL	ROAD_SA	5
377	578572.54	4140404.74	0.20494	14.61	14.61	0	ANNUAL	ROAD_SA	5
378	578597.54	4140404.74	0.26978	14.37	14.37	0	ANNUAL	ROAD_SA	5
379	578622.54	4140404.74	0.35799	14.65	14.65	0	ANNUAL	ROAD_SA	5
380	578647.54	4140404.74	0.47685	14.52	14.52	0	ANNUAL	ROAD_SA	5
381	578672.54	4140404.74	0.64221	14.2	14.2	0	ANNUAL	ROAD_SA	5
382	578697.54	4140404.74	0.89862	14.56	14.56	0	ANNUAL	ROAD_SA	5
383	578847.54	4140404.74	6.41015	14.55	17.95	0	ANNUAL	ROAD_SA	5
384	578872.54	4140404.74	4.87728	13.81	20.21	0	ANNUAL	ROAD_SA	5
385	578897.54	4140404.74	3.98786	14.1	14.1	0	ANNUAL	ROAD_SA	5
386	578922.54	4140404.74	3.38582	14.83	14.83	0	ANNUAL	ROAD_SA	5
387	578947.54	4140404.74	2.89983	14.61	14.61	0	ANNUAL	ROAD_SA	5
388	578972.54	4140404.74	2.4977	14.03	14.03	0	ANNUAL	ROAD_SA	5
389	578997.54	4140404.74	2.12729	13.36	13.36	0	ANNUAL	ROAD_SA	5
390	578372.54	4140429.74	0.04202	14.89	14.89	0	ANNUAL	ROAD_SA	5
391	578397.54	4140429.74	0.04924	14.79	14.79	0	ANNUAL	ROAD_SA	5
392	578422.54	4140429.74	0.05837	14.55	14.55	0	ANNUAL	ROAD_SA	5
393	578447.54	4140429.74	0.07008	14.44	14.44	0	ANNUAL	ROAD_SA	5
394	578472.54	4140429.74	0.0852	14.29	14.29	0	ANNUAL	ROAD_SA	5
395	578497.54	4140429.74	0.10493	13.79	13.79	0	ANNUAL	ROAD_SA	5
396	578522.54	4140429.74	0.13077	14.17	14.17	0	ANNUAL	ROAD_SA	5
397	578547.54	4140429.74	0.16459	14.11	14.11	0	ANNUAL	ROAD_SA	5
398	578572.54	4140429.74	0.20885	14.49	14.49	0	ANNUAL	ROAD_SA	5
399	578597.54	4140429.74	0.26581	14.39	14.39	0	ANNUAL	ROAD_SA	5
400	578622.54	4140429.74	0.33896	14.44	14.44	0	ANNUAL	ROAD_SA	5
401	578647.54	4140429.74	0.43304	14.52	14.52	0	ANNUAL	ROAD_SA	5
402	578672.54	4140429.74	0.55686	14.59	14.59	0	ANNUAL	ROAD_SA	5
403	578697.54	4140429.74	0.72745	14.54	14.54	0	ANNUAL	ROAD_SA	5
404	578722.54	4140429.74	6.33108	13.65	20.97	0	ANNUAL	ROAD_SA	5
405	578897.54	4140429.74	5.04513	14.72	20.97	0	ANNUAL	ROAD_SA	5
406	578922.54	4140429.74	4.13946	14.86	14.86	0	ANNUAL	ROAD_SA	5
407	578947.54	4140429.74	3.44775	14.74	14.74	0	ANNUAL	ROAD_SA	5
408	578972.54	4140429.74	2.87916	13.22	14.71	0	ANNUAL	ROAD_SA	5
409	578372.54	4140454.74	0.04613	14.29	14.29	0	ANNUAL	ROAD_SA	5
410	578397.54	4140454.74	0.05399	14.25	14.25	0	ANNUAL	ROAD_SA	5
411	578422.54	4140454.74	0.06384	14.59	14.59	0	ANNUAL	ROAD_SA	5
412	578447.54	4140454.74	0.07617	14.04	14.04	0	ANNUAL	ROAD_SA	5
413	578472.54	4140454.74	0.09183	14.01	14.01	0	ANNUAL	ROAD_SA	5
414	578497.54	4140454.74	0.11168	13.63	13.63	0	ANNUAL	ROAD_SA	5
415	578522.54	4140454.74	0.13693	13.84	13.84	0	ANNUAL	ROAD_SA	5
416	578547.54	4140454.74	0.16866	13.99	13.99	0	ANNUAL	ROAD_SA	5
417	578572.54	4140454.74	0.20837	13.98	13.98	0	ANNUAL	ROAD_SA	5
418	578597.54	4140454.74	0.25744	13.94	13.94	0	ANNUAL	ROAD_SA	5
419	578622.54	4140454.74	0.31774	13.97	13.97	0	ANNUAL	ROAD_SA	5
420	578647.54	4140454.74	0.39253	14.48	14.48	0	ANNUAL	ROAD_SA	5
421	578672.54	4140454.74	0.48496	14.53	14.53	0	ANNUAL	ROAD_SA	5
422	578697.54	4140454.74	0.6019	14.2	14.2	0	ANNUAL	ROAD_SA	5
423	578722.54	4140454.74	0.75857	14.19	14.19	0	ANNUAL	ROAD_SA	5
424	578747.54	4140454.74	0.98454	14.45	14.45	0	ANNUAL	ROAD_SA	5
425	578772.54	4140454.74	1.29804	13.77	13.77	0	ANNUAL	ROAD_SA	5
426	578897.54	4140454.74	6.54402	13.57	20.97	0	ANNUAL	ROAD_SA	5
427	578922.54	4140454.74	5.26411	14.71	20.97	0	ANNUAL	ROAD_SA	5
428	578947.54	4140454.74	4.16904	13.27	20.97	0	ANNUAL	ROAD_SA	5
429	578547.54	4140479.74	0.16981	13.71	13.71	0	ANNUAL	ROAD_SA	5
430	578572.54	4140479.74	0.20493	13.65	13.65	0	ANNUAL	ROAD_SA	5
431	578597.54	4140479.74	0.247	13.82	13.82	0	ANNUAL	ROAD_SA	5
432	578622.54	4140479.74	0.29663	13.84	13.84	0	ANNUAL	ROAD_SA	5
433	578647.54	4140479.74	0.35535	14.06	14.06	0	ANNUAL	ROAD_SA	5
434	578672.54	4140479.74	0.42531	14.22	14.22	0	ANNUAL	ROAD_SA	5
435	578697.54	4140479.74	0.50873	13.88	13.88	0	ANNUAL	ROAD_SA	5
436	578722.54	4140479.74	0.61139	13.55	13.55	0	ANNUAL	ROAD_SA	5
437	578747.54	4140479.74	0.75742	14.73	14.73	0	ANNUAL	ROAD_SA	5
438	578772.54	4140479.74	0.94403	14.05	14.05	0	ANNUAL	ROAD_SA	5
439	578547.54	4140504.74	0.16842	13.26	13.26	0	ANNUAL	ROAD_SA	5
440	578572.54	4140504.74	0.19953	13.84	13.84	0	ANNUAL	ROAD_SA	5
441	578597.54	4140504.74	0.2351	13.76	13.76	0	ANNUAL	ROAD_SA	5
442	578622.54	4140504.74	0.27591	13.74	13.74	0	ANNUAL	ROAD_SA	5
443	578647.54	4140504.74	0.3226	13.78	13.78	0	ANNUAL	ROAD_SA	5
444	578672.54	4140504.74	0.37638	14.03	14.03	0	ANNUAL	ROAD_SA	5
445	578697.54	4140504.74	0.43931	14.25	14.25	0	ANNUAL	ROAD_SA	5
446	578722.54	4140504.74	0.51317	13.86	13.86	0	ANNUAL	ROAD_SA	5
447	578747.54	4140504.74	0.60643	13.93	13.93	0	ANNUAL	ROAD_SA	5
448	578772.54	4140504.74	0.72984	14.06	14.06	0	ANNUAL	ROAD_SA	5
449	578729.86	4140254.76	6.6129	15.3	15.3	0	ANNUAL	ROAD_SA	5
450	578721.07	4140258.69	8.34265	15.17	15.17	0	ANNUAL	ROAD_SA	5
451	578715.45	4140261.12	9.88825	15.27	15.27	0	ANNUAL	ROAD_SA	5
452	578707.87	4140264.31	12.70082	15.26	15.26	0	ANNUAL	ROAD_SA	5
453	578737.07	4140251.11	5.55712	15.29	15.29	0	ANNUAL	ROAD_SA	5
454	578743.99	4140247.74	4.80244	15.38	15.38	0	ANNUAL	ROAD_SA	5
455	578752.23	4140244.47	4.14059	15.4	15.4	0	ANNUAL	ROAD_SA	5
456	578779.94	4140231.11	2.76188	15.37	15.37	0	ANNUAL	ROAD_SA	5
457	578792.09	4140225.66	2.41476	15.54	15.54	0	ANNUAL	ROAD_SA	5

AERMOD Concentrations for PM2.5 (On-site Site Grading; Worker Commute Vehicles on California Street and San Antonio Road)

369	578372.54	4140404.74	0.34429	15.04	15.04	0	ANNUAL	PAREA1	5
370	578397.54	4140404.74	0.41293	15.08	15.08	0	ANNUAL	PAREA1	5
371	578422.54	4140404.74	0.49819	14.71	14.71	0	ANNUAL	PAREA1	5
372	578447.54	4140404.74	0.60388	14.7	14.7	0	ANNUAL	PAREA1	5
373	578472.54	4140404.74	0.7322	14.25	14.25	0	ANNUAL	PAREA1	5
374	578497.54	4140404.74	0.88386	13.95	13.95	0	ANNUAL	PAREA1	5
375	578522.54	4140404.74	1.05542	14.41	14.41	0	ANNUAL	PAREA1	5
376	578547.54	4140404.74	1.22988	14.61	14.61	0	ANNUAL	PAREA1	5
377	578572.54	4140404.74	1.37894	14.61	14.61	0	ANNUAL	PAREA1	5
378	578597.54	4140404.74	1.46289	14.37	14.37	0	ANNUAL	PAREA1	5
379	578622.54	4140404.74	1.44797	14.65	14.65	0	ANNUAL	PAREA1	5
380	578647.54	4140404.74	1.32067	14.52	14.52	0	ANNUAL	PAREA1	5
381	578672.54	4140404.74	1.11263	14.2	14.2	0	ANNUAL	PAREA1	5
382	578697.54	4140404.74	0.8837	14.56	14.56	0	ANNUAL	PAREA1	5
383	578847.54	4140404.74	0.31479	14.55	17.95	0	ANNUAL	PAREA1	5
384	578872.54	4140404.74	0.2966	13.81	20.21	0	ANNUAL	PAREA1	5
385	578897.54	4140404.74	0.28012	14.1	14.1	0	ANNUAL	PAREA1	5
386	578922.54	4140404.74	0.26357	14.83	14.83	0	ANNUAL	PAREA1	5
387	578947.54	4140404.74	0.24642	14.61	14.61	0	ANNUAL	PAREA1	5
388	578972.54	4140404.74	0.22918	14.03	14.03	0	ANNUAL	PAREA1	5
389	578997.54	4140404.74	0.21243	13.36	13.36	0	ANNUAL	PAREA1	5
390	578372.54	4140429.74	0.36483	14.89	14.89	0	ANNUAL	PAREA1	5
391	578397.54	4140429.74	0.43286	14.79	14.79	0	ANNUAL	PAREA1	5
392	578422.54	4140429.74	0.5151	14.55	14.55	0	ANNUAL	PAREA1	5
393	578447.54	4140429.74	0.6131	14.44	14.44	0	ANNUAL	PAREA1	5
394	578472.54	4140429.74	0.72643	14.29	14.29	0	ANNUAL	PAREA1	5
395	578497.54	4140429.74	0.85056	13.79	13.79	0	ANNUAL	PAREA1	5
396	578522.54	4140429.74	0.97853	14.17	14.17	0	ANNUAL	PAREA1	5
397	578547.54	4140429.74	1.09104	14.11	14.11	0	ANNUAL	PAREA1	5
398	578572.54	4140429.74	1.16685	14.49	14.49	0	ANNUAL	PAREA1	5
399	578597.54	4140429.74	1.17958	14.39	14.39	0	ANNUAL	PAREA1	5
400	578622.54	4140429.74	1.11752	14.44	14.44	0	ANNUAL	PAREA1	5
401	578647.54	4140429.74	0.98909	14.52	14.52	0	ANNUAL	PAREA1	5
402	578672.54	4140429.74	0.82454	14.59	14.59	0	ANNUAL	PAREA1	5
403	578697.54	4140429.74	0.6601	14.54	14.54	0	ANNUAL	PAREA1	5
404	578872.54	4140429.74	0.2423	13.65	20.97	0	ANNUAL	PAREA1	5
405	578897.54	4140429.74	0.23166	14.72	20.97	0	ANNUAL	PAREA1	5
406	578922.54	4140429.74	0.22088	14.86	14.86	0	ANNUAL	PAREA1	5
407	578947.54	4140429.74	0.20952	14.74	14.74	0	ANNUAL	PAREA1	5
408	578972.54	4140429.74	0.19722	13.22	14.71	0	ANNUAL	PAREA1	5
409	578372.54	4140454.74	0.3792	14.29	14.29	0	ANNUAL	PAREA1	5
410	578397.54	4140454.74	0.44462	14.25	14.25	0	ANNUAL	PAREA1	5
411	578422.54	4140454.74	0.52137	14.59	14.59	0	ANNUAL	PAREA1	5
412	578447.54	4140454.74	0.6079	14.04	14.04	0	ANNUAL	PAREA1	5
413	578472.54	4140454.74	0.70248	14.01	14.01	0	ANNUAL	PAREA1	5
414	578497.54	4140454.74	0.79789	13.63	13.63	0	ANNUAL	PAREA1	5
415	578522.54	4140454.74	0.88538	13.84	13.84	0	ANNUAL	PAREA1	5
416	578547.54	4140454.74	0.94941	13.99	13.99	0	ANNUAL	PAREA1	5
417	578572.54	4140454.74	0.97384	13.98	13.98	0	ANNUAL	PAREA1	5
418	578597.54	4140454.74	0.94728	13.94	13.94	0	ANNUAL	PAREA1	5
419	578622.54	4140454.74	0.86967	13.97	13.97	0	ANNUAL	PAREA1	5
420	578647.54	4140454.74	0.756	14.48	14.48	0	ANNUAL	PAREA1	5
421	578672.54	4140454.74	0.62836	14.53	14.53	0	ANNUAL	PAREA1	5
422	578697.54	4140454.74	0.5091	14.2	14.2	0	ANNUAL	PAREA1	5
423	578722.54	4140454.74	0.41094	14.19	14.19	0	ANNUAL	PAREA1	5
424	578747.54	4140454.74	0.33649	14.45	14.45	0	ANNUAL	PAREA1	5
425	578772.54	4140454.74	0.28329	13.77	13.77	0	ANNUAL	PAREA1	5
426	578897.54	4140454.74	0.19328	13.57	20.97	0	ANNUAL	PAREA1	5
427	578922.54	4140454.74	0.18648	14.71	20.97	0	ANNUAL	PAREA1	5
428	578947.54	4140454.74	0.1789	13.27	20.97	0	ANNUAL	PAREA1	5
429	578547.54	4140479.74	0.81489	13.71	13.71	0	ANNUAL	PAREA1	5
430	578572.54	4140479.74	0.80789	13.65	13.65	0	ANNUAL	PAREA1	5
431	578597.54	4140479.74	0.76308	13.82	13.82	0	ANNUAL	PAREA1	5
432	578622.54	4140479.74	0.68526	13.84	13.84	0	ANNUAL	PAREA1	5
433	578647.54	4140479.74	0.58911	14.06	14.06	0	ANNUAL	PAREA1	5
434	578672.54	4140479.74	0.49109	14.22	14.22	0	ANNUAL	PAREA1	5
435	578697.54	4140479.74	0.40348	13.88	13.88	0	ANNUAL	PAREA1	5
436	578722.54	4140479.74	0.33204	13.55	13.55	0	ANNUAL	PAREA1	5
437	578747.54	4140479.74	0.27747	14.73	14.73	0	ANNUAL	PAREA1	5
438	578772.54	4140479.74	0.2369	14.05	14.05	0	ANNUAL	PAREA1	5
439	578547.54	4140504.74	0.69356	13.26	13.26	0	ANNUAL	PAREA1	5
440	578572.54	4140504.74	0.66995	13.84	13.84	0	ANNUAL	PAREA1	5
441	578597.54	4140504.74	0.61823	13.76	13.76	0	ANNUAL	PAREA1	5
442	578622.54	4140504.74	0.54698	13.74	13.74	0	ANNUAL	PAREA1	5
443	578647.54	4140504.74	0.46796	13.78	13.78	0	ANNUAL	PAREA1	5
444	578672.54	4140504.74	0.3926	14.03	14.03	0	ANNUAL	PAREA1	5
445	578697.54	4140504.74	0.32746	14.25	14.25	0	ANNUAL	PAREA1	5
446	578722.54	4140504.74	0.27427	13.86	13.86	0	ANNUAL	PAREA1	5
447	578747.54	4140504.74	0.2327	13.93	13.93	0	ANNUAL	PAREA1	5
448	578772.54	4140504.74	0.20122	14.06	14.06	0	ANNUAL	PAREA1	5
449	578729.86	4140254.76	13.90544	15.3	15.3	0	ANNUAL	PAREA1	5
450	578721.07	4140258.69	13.70099	15.17	15.17	0	ANNUAL	PAREA1	5
451	578715.45	4140261.12	13.57602	15.27	15.27	0	ANNUAL	PAREA1	5
452	578707.87	4140264.31	13.37111	15.26	15.26	0	ANNUAL	PAREA1	5
453	578737.07	4140251.11	14.12496	15.29	15.29	0	ANNUAL	PAREA1	5
454	578743.99	4140247.74	14.05214	15.38	15.38	0	ANNUAL	PAREA1	5
455	578752.23	4140244.47	13.16763	15.4	15.4	0	ANNUAL	PAREA1	5
456	578779.94	4140231.11	10.06112	15.37	15.37	0	ANNUAL	PAREA1	5
457	578792.09	4140225.66	8.81965	15.54	15.54	0	ANNUAL	PAREA1	5

369	578372.54	4140404.74	0.28669	15.04	15.04	0	ANNUAL	ROAD_CA	5
370	578397.54	4140404.74	0.3469	15.08	15.08	0	ANNUAL	ROAD_CA	5
371	578422.54	4140404.74	0.42374	14.71	14.71	0	ANNUAL	ROAD_CA	5
372	578447.54	4140404.74	0.52214	14.7	14.7	0	ANNUAL	ROAD_CA	5
373	578472.54	4140404.74	0.64803	14.25	14.25	0	ANNUAL	ROAD_CA	5
374	578497.54	4140404.74	0.80876	13.95	13.95	0	ANNUAL	ROAD_CA	5
375	578522.54	4140404.74	1.01223	14.41	14.41	0	ANNUAL	ROAD_CA	5
376	578547.54	4140404.74	1.25816	14.61	14.61	0	ANNUAL	ROAD_CA	5
377	578572.54	4140404.74	1.53492	14.61	14.61	0	ANNUAL	ROAD_CA	5
378	578597.54	4140404.74	1.80536	14.37	14.37	0	ANNUAL	ROAD_CA	5
379	578622.54	4140404.74	2.00432	14.65	14.65	0	ANNUAL	ROAD_CA	5
380	578647.54	4140404.74	2.04237	14.52	14.52	0	ANNUAL	ROAD_CA	5
381	578672.54	4140404.74	1.8728	14.2	14.2	0	ANNUAL	ROAD_CA	5
382	578697.54	4140404.74	1.54603	14.56	14.56	0	ANNUAL	ROAD_CA	5
383	578847.54	4140404.74	0.44808	14.55	17.95	0	ANNUAL	ROAD_CA	5
384	578872.54	4140404.74	0.41324	13.81	20.21	0	ANNUAL	ROAD_CA	5
385	578897.54	4140404.74	0.38168	14.1	14.1	0	ANNUAL	ROAD_CA	5
386	578922.54	4140404.74	0.35172	14.83	14.83	0	ANNUAL	ROAD_CA	5
387	578947.54	4140404.74	0.32313	14.61	14.61	0	ANNUAL	ROAD_CA	5
388	578972.54	4140404.74	0.29646	14.03	14.03	0	ANNUAL	ROAD_CA	5
389	578997.54	4140404.74	0.27193	13.36	13.36	0	ANNUAL	ROAD_CA	5
390	578372.54	4140429.74	0.31478	14.89	14.89	0	ANNUAL	ROAD_CA	5
391	578397.54	4140429.74	0.37739	14.79	14.79	0	ANNUAL	ROAD_CA	5
392	578422.54	4140429.74	0.45534	14.55	14.55	0	ANNUAL	ROAD_CA	5
393	578447.54	4140429.74	0.55251	14.44	14.44	0	ANNUAL	ROAD_CA	5
394	578472.54	4140429.74	0.67262	14.29	14.29	0	ANNUAL	ROAD_CA	5
395	578497.54	4140429.74	0.81773	13.79	13.79	0	ANNUAL	ROAD_CA	5
396	578522.54	4140429.74	0.98991	14.17	14.17	0	ANNUAL	ROAD_CA	5
397	578547.54	4140429.74	1.17909	14.11	14.11	0	ANNUAL	ROAD_CA	5
398	578572.54	4140429.74	1.36746	14.49	14.49	0	ANNUAL	ROAD_CA	5
399	578597.54	4140429.74	1.51623	14.39	14.39	0	ANNUAL	ROAD_CA	5
400	578622.54	4140429.74	1.58061	14.44	14.44	0	ANNUAL	ROAD_CA	5
401	578647.54	4140429.74	1.52347	14.52	14.52	0	ANNUAL	ROAD_CA	5
402	578672.54	4140429.74	1.34623	14.59	14.59	0	ANNUAL	ROAD_CA	5
403	578697.54	4140429.74	1.09779	14.54	14.54	0	ANNUAL	ROAD_CA	5
404	578872.54	4140429.74	0.32932	13.65	20.97	0	ANNUAL	ROAD_CA	5
405	578897.54	4140429.74	0.30873	14.72	20.97	0	ANNUAL	ROAD_CA	5
406	578922.54	4140429.74	0.28845	14.86	14.86	0	ANNUAL	ROAD_CA	5
407	578947.54	4140429.74	0.26873	14.74	14.74	0	ANNUAL	ROAD_CA	5
408	578972.54	4140429.74	0.24931	13.22	14.71	0	ANNUAL	ROAD_CA	5
409	578372.54	4140454.74	0.33683	14.29	14.29	0	ANNUAL	ROAD_CA	5
410	578397.54	4140454.74	0.39956	14.25	14.25	0	ANNUAL	ROAD_CA	5
411	578422.54	4140454.74	0.47608	14.59	14.59	0	ANNUAL	ROAD_CA	5
412	578447.54	4140454.74	0.56766	14.04	14.04	0	ANNUAL	ROAD_CA	5
413	578472.54	4140454.74	0.67646	14.01	14.01	0	ANNUAL	ROAD_CA	5
414	578497.54	4140454.74	0.80066	13.63	13.63	0	ANNUAL	ROAD_CA	5
415	578522.54	4140454.74	0.93687	13.84	13.84	0	ANNUAL	ROAD_CA	5
416	578547.54	4140454.74	1.07208	13.99	13.99	0	ANNUAL	ROAD_CA	5
417	578572.54	4140454.74	1.18553	13.98	13.98	0	ANNUAL	ROAD_CA	5
418	578597.54	4140454.74	1.25037	13.94	13.94	0	ANNUAL	ROAD_CA	5
419	578622.54	4140454.74	1.24177	13.97	13.97	0	ANNUAL	ROAD_CA	5
420	578647.54	4140454.74	1.15178	14.48	14.48	0	ANNUAL	ROAD_CA	5
421	578672.54	4140454.74	0.99486	14.53	14.53	0	ANNUAL	ROAD_CA	5
422	578697.54	4140454.74	0.80975	14.2	14.2	0	ANNUAL	ROAD_CA	5
423	578722.54	4140454.74	0.63701	14.19	14.19	0	ANNUAL	ROAD_CA	5
424	578747.54	4140454.74	0.50002	14.45	14.45	0	ANNUAL	ROAD_CA	5
425	578772.54	4140454.74	0.4038	13.77	13.77	0	ANNUAL	ROAD_CA	5
426	578897.54	4140454.74	0.2534	13.57	20.97	0	ANNUAL	ROAD_CA	5
427	578922.54	4140454.74	0.23991	14.71	20.97	0	ANNUAL	ROAD_CA	5
428	578947.54	4140454.74	0.22585	13.27	20.97	0	ANNUAL	ROAD_CA	5
429	578547.54	4140479.74	0.95254	13.71	13.71	0	ANNUAL	ROAD_CA	5
430	578572.54	4140479.74	1.01099	13.65	13.65	0	ANNUAL	ROAD_CA	5
431	578597.54	4140479.74	1.02388	13.82	13.82	0	ANNUAL	ROAD_CA	5
432	578622.54	4140479.74	0.98008	13.84	13.84	0	ANNUAL	ROAD_CA	5
433	578647.54	4140479.74	0.88426	14.06	14.06	0	ANNUAL	ROAD_CA	5
434	578672.54	4140479.74	0.75481	14.22	14.22	0	ANNUAL	ROAD_CA	5
435	578697.54	4140479.74	0.61723	13.88	13.88	0	ANNUAL	ROAD_CA	5
436	578722.54	4140479.74	0.49411	13.55	13.55	0	ANNUAL	ROAD_CA	5
437	578747.54	4140479.74	0.39767	14.73	14.73	0	ANNUAL	ROAD_CA	5
438	578772.54	4140479.74	0.32749	14.05	14.05	0	ANNUAL	ROAD_CA	5
439	578547.54	4140504.74	0.83255	13.26	13.26	0	ANNUAL	ROAD_CA	5
440	578572.54	4140504.74	0.85474	13.84	13.84	0	ANNUAL	ROAD_CA	5
441	578597.54	4140504.74	0.83701	13.76	13.76	0	ANNUAL	ROAD_CA	5
442	578622.54	4140504.74	0.7795	13.74	13.74	0	ANNUAL	ROAD_CA	5
443	578647.54	4140504.74	0.69074	13.78	13.78	0	ANNUAL	ROAD_CA	5
444	578672.54	4140504.74	0.58683	14.03	14.03	0	ANNUAL	ROAD_CA	5
445	578697.54	4140504.74	0.48427	14.25	14.25	0	ANNUAL	ROAD_CA	5
446	578722.54	4140504.74	0.39448	13.86	13.86	0	ANNUAL	ROAD_CA	5
447	578747.54	4140504.74	0.3234	13.93	13.93	0	ANNUAL	ROAD_CA	5
448	578772.54	4140504.74	0.271	14.06	14.06	0	ANNUAL	ROAD_CA	5
449	578729.86	4140254.76	116.60284	15.3	15.3	0	ANNUAL	ROAD_CA	5
450	578721.07	4140258.69	108.05881	15.17	15.17	0	ANNUAL	ROAD_CA	5
451	578715.45	4140261.12	102.09774	15.27	15.27	0	ANNUAL	ROAD_CA	5
452	578707.87	4140264.31	83.01956	15.26	15.26	0	ANNUAL	ROAD_CA	5
453	578737.07	4140251.11	124.40833	15.29	15.29	0	ANNUAL	ROAD_CA	5
454	578743.99	4140247.74	129.63627	15.38	15.38	0	ANNUAL	ROAD_CA	5
455	578752.23	4140244.47	120.2225	15.4	15.4	0	ANNUAL	ROAD_CA	5
456	578779.94	4140231.11	72.34758	15.37	15.37	0	ANNUAL	ROAD_CA	5
457	578792.09	4140225.66	37.14878	15.54	15.54	0	ANNUAL	ROAD_CA	5

369	578372.54	4140404.74	0.03525	15.04	15.04	0	ANNUAL	ROAD_SA	5
370	578397.54	4140404.74	0.04149	15.08	15.08	0	ANNUAL	ROAD_SA	5
371	578422.54	4140404.74	0.04963	14.71	14.71	0	ANNUAL	ROAD_SA	5
372	578447.54	4140404.74	0.06031	14.7	14.7	0	ANNUAL	ROAD_SA	5
373	578472.54	4140404.74	0.07464	14.25	14.25	0	ANNUAL	ROAD_SA	5
374	578497.54	4140404.74	0.09413	13.95	13.95	0	ANNUAL	ROAD_SA	5
375	578522.54	4140404.74	0.12102	14.41	14.41	0	ANNUAL	ROAD_SA	5
376	578547.54	4140404.74	0.15831	14.61	14.61	0	ANNUAL	ROAD_SA	5
377	578572.54	4140404.74	0.20981	14.61	14.61	0	ANNUAL	ROAD_SA	5
378	578597.54	4140404.74	0.27989	14.37	14.37	0	ANNUAL	ROAD_SA	5
379	578622.54	4140404.74	0.3744	14.65	14.65	0	ANNUAL	ROAD_SA	5
380	578647.54	4140404.74	0.50163	14.52	14.52	0	ANNUAL	ROAD_SA	5
381	578672.54	4140404.74	0.68143	14.2	14.2	0	ANNUAL	ROAD_SA	5
382	578697.54	4140404.74	0.96941	14.56	14.56	0	ANNUAL	ROAD_SA	5
383	578847.54	4140404.74	7.29877	14.55	17.95	0	ANNUAL	ROAD_SA	5
384	578872.54	4140404.74	5.3321	13.81	20.21	0	ANNUAL	ROAD_SA	5
385	578897.54	4140404.74	4.25722	14.1	14.1	0	ANNUAL	ROAD_SA	5
386	578922.54	4140404.74	3.55736	14.83	14.83	0	ANNUAL	ROAD_SA	5
387	578947.54	4140404.74	3.02313	14.61	14.61	0	ANNUAL	ROAD_SA	5
388	578972.54	4140404.74	2.59135	14.03	14.03	0	ANNUAL	ROAD_SA	5
389	578997.54	4140404.74	2.2487	13.36	13.36	0	ANNUAL	ROAD_SA	5
390	578372.54	4140429.74	0.03942	14.89	14.89	0	ANNUAL	ROAD_SA	5
391	578397.54	4140429.74	0.04653	14.79	14.79	0	ANNUAL	ROAD_SA	5
392	578422.54	4140429.74	0.05566	14.55	14.55	0	ANNUAL	ROAD_SA	5
393	578447.54	4140429.74	0.06752	14.44	14.44	0	ANNUAL	ROAD_SA	5
394	578472.54	4140429.74	0.08311	14.29	14.29	0	ANNUAL	ROAD_SA	5
395	578497.54	4140429.74	0.10375	13.79	13.79	0	ANNUAL	ROAD_SA	5
396	578522.54	4140429.74	0.13119	14.17	14.17	0	ANNUAL	ROAD_SA	5
397	578547.54	4140429.74	0.16746	14.11	14.11	0	ANNUAL	ROAD_SA	5
398	578572.54	4140429.74	0.215	14.49	14.49	0	ANNUAL	ROAD_SA	5
399	578597.54	4140429.74	0.27604	14.39	14.39	0	ANNUAL	ROAD_SA	5
400	578622.54	4140429.74	0.35366	14.44	14.44	0	ANNUAL	ROAD_SA	5
401	578647.54	4140429.74	0.45305	14.52	14.52	0	ANNUAL	ROAD_SA	5
402	578672.54	4140429.74	0.58492	14.59	14.59	0	ANNUAL	ROAD_SA	5
403	578697.54	4140429.74	0.77101	14.54	14.54	0	ANNUAL	ROAD_SA	5
404	578872.54	4140429.74	7.32086	13.65	20.97	0	ANNUAL	ROAD_SA	5
405	578897.54	4140429.74	5.54224	14.72	20.97	0	ANNUAL	ROAD_SA	5
406	578922.54	4140429.74	4.41052	14.86	14.86	0	ANNUAL	ROAD_SA	5
407	578947.54	4140429.74	3.6175	14.74	14.74	0	ANNUAL	ROAD_SA	5
408	578972.54	4140429.74	2.99933	13.22	14.71	0	ANNUAL	ROAD_SA	5
409	578372.54	4140454.74	0.04375	14.29	14.29	0	ANNUAL	ROAD_SA	5
410	578397.54	4140454.74	0.05162	14.25	14.25	0	ANNUAL	ROAD_SA	5
411	578422.54	4140454.74	0.0616	14.59	14.59	0	ANNUAL	ROAD_SA	5
412	578447.54	4140454.74	0.07434	14.04	14.04	0	ANNUAL	ROAD_SA	5
413	578472.54	4140454.74	0.0907	14.01	14.01	0	ANNUAL	ROAD_SA	5
414	578497.54	4140454.74	0.1117	13.63	13.63	0	ANNUAL	ROAD_SA	5
415	578522.54	4140454.74	0.13865	13.84	13.84	0	ANNUAL	ROAD_SA	5
416	578547.54	4140454.74	0.17275	13.99	13.99	0	ANNUAL	ROAD_SA	5
417	578572.54	4140454.74	0.21525	13.98	13.98	0	ANNUAL	ROAD_SA	5
418	578597.54	4140454.74	0.26738	13.94	13.94	0	ANNUAL	ROAD_SA	5
419	578622.54	4140454.74	0.33076	13.97	13.97	0	ANNUAL	ROAD_SA	5
420	578647.54	4140454.74	0.40865	14.48	14.48	0	ANNUAL	ROAD_SA	5
421	578672.54	4140454.74	0.50581	14.53	14.53	0	ANNUAL	ROAD_SA	5
422	578697.54	4140454.74	0.63144	14.2	14.2	0	ANNUAL	ROAD_SA	5
423	578722.54	4140454.74	0.80425	14.19	14.19	0	ANNUAL	ROAD_SA	5
424	578747.54	4140454.74	1.06628	14.45	14.45	0	ANNUAL	ROAD_SA	5
425	578772.54	4140454.74	1.48921	13.77	13.77	0	ANNUAL	ROAD_SA	5
426	578897.54	4140454.74	7.52363	13.57	20.97	0	ANNUAL	ROAD_SA	5
427	578922.54	4140454.74	5.72766	14.71	20.97	0	ANNUAL	ROAD_SA	5
428	578947.54	4140454.74	4.41386	13.27	20.97	0	ANNUAL	ROAD_SA	5
429	578547.54	4140479.74	0.17466	13.71	13.71	0	ANNUAL	ROAD_SA	5
430	578572.54	4140479.74	0.21199	13.65	13.65	0	ANNUAL	ROAD_SA	5
431	578597.54	4140479.74	0.25615	13.82	13.82	0	ANNUAL	ROAD_SA	5
432	578622.54	4140479.74	0.30778	13.84	13.84	0	ANNUAL	ROAD_SA	5
433	578647.54	4140479.74	0.36858	14.06	14.06	0	ANNUAL	ROAD_SA	5
434	578672.54	4140479.74	0.44125	14.22	14.22	0	ANNUAL	ROAD_SA	5
435	578697.54	4140479.74	0.52962	13.88	13.88	0	ANNUAL	ROAD_SA	5
436	578722.54	4140479.74	0.64112	13.55	13.55	0	ANNUAL	ROAD_SA	5
437	578747.54	4140479.74	0.80006	14.73	14.73	0	ANNUAL	ROAD_SA	5
438	578772.54	4140479.74	1.02084	14.05	14.05	0	ANNUAL	ROAD_SA	5
439	578547.54	4140504.74	0.17379	13.26	13.26	0	ANNUAL	ROAD_SA	5
440	578572.54	4140504.74	0.20643	13.84	13.84	0	ANNUAL	ROAD_SA	5
441	578597.54	4140504.74	0.24344	13.76	13.76	0	ANNUAL	ROAD_SA	5
442	578622.54	4140504.74	0.28545	13.74	13.74	0	ANNUAL	ROAD_SA	5
443	578647.54	4140504.74	0.33333	13.78	13.78	0	ANNUAL	ROAD_SA	5
444	578672.54	4140504.74	0.38868	14.03	14.03	0	ANNUAL	ROAD_SA	5
445	578697.54	4140504.74	0.45407	14.25	14.25	0	ANNUAL	ROAD_SA	5
446	578722.54	4140504.74	0.53271	13.86	13.86	0	ANNUAL	ROAD_SA	5
447	578747.54	4140504.74	0.63369	13.93	13.93	0	ANNUAL	ROAD_SA	5
448	578772.54	4140504.74	0.77062	14.06	14.06	0	ANNUAL	ROAD_SA	5
449	578729.86	4140254.76	7.48571	15.3	15.3	0	ANNUAL	ROAD_SA	5
450	578721.07	4140258.69	10.15972	15.17	15.17	0	ANNUAL	ROAD_SA	5
451	578715.45	4140261.12	13.09082	15.27	15.27	0	ANNUAL	ROAD_SA	5
452	578707.87	4140264.31	20.31695	15.26	15.26	0	ANNUAL	ROAD_SA	5
453	578737.07	4140251.11	6.09617	15.29	15.29	0	ANNUAL	ROAD_SA	5
454	578743.99	4140247.74	5.17019	15.38	15.38	0	ANNUAL	ROAD_SA	5
455	578752.23	4140244.47	4.39912	15.4	15.4	0	ANNUAL	ROAD_SA	5
456	578779.94	4140231.11	2.87403	15.37	15.37	0	ANNUAL	ROAD_SA	5
457	578792.09	4140225.66	2.49999	15.54	15.54	0	ANNUAL	ROAD_SA	5

**Diesel Particulate Matter Concentrations and Health Risk Calculations (On-site Off-Road Equipment;
Truck Hauling on California Street and San Antonio Road)**

Unmitigated Health Risk Calculations - Risk Scenario 1 (Third Trimester Occurs in 2022)

Methodology, Air Toxics Hot Spots Program Guidance Manual for the Preparation of Risk Assessments_Final_March 2015

https://envhhs.ca.gov/air/online-adoption-air-toxics-hot-spots-program-guidance-manual-preparation-health-risk-0

Table with columns: Receptor #, Receptor ID, Adjusted Average Annual Concentration from AERMOD, Adjusted Average Annual Concentration from AERMOD 2-9 Years, Adjusted Average Annual Concentration from AERMOD 2-9 Years, Adjusted Average Annual Concentration from AERMOD 2-16 Years, Adjusted Average Annual Concentration from AERMOD 2-9 Years, Adjusted Average Annual Concentration from AERMOD 2-16 Years, and various Cancer and Risk metrics (Cancer Risk, Risk, Risk, Risk, Cancer Risk, Total Cancer Risk, per million, Index).

	2022	259	25.9142	0.0000029	6.479	19.436	0.000	0.0000	0.0000	0.0000	-	0.000000
	2023	260	0.8232	0.0000001	0.000	0.823	0.000	0.0000	0.0000	0.0000	-	0.000000
	2024	117	0.3799	0.0000001	0.000	0.150	0.190	0.0000	0.0000	0.0000	-	0.000000
	Total	636			6.479	20.449	0.190	0.0000	0.0000	0.0000	-	
Source Group 3	2022	259	518.8206	0.0000586	129.705	389.115	0.000	0.0000	0.0000	0.0000	-	0.000000
	2023	260	16.4802	0.0000019	0.000	16.480	0.000	0.0000	0.0000	0.0000	-	0.000000
	2024	117	7.6062	0.0000019	0.000	3.803	3.803	0.0000	0.0000	0.0000	-	0.000000
	Total	636			129.705	409.399	3.803	0.0000	0.0000	0.0000	-	

2022	1.00	0.25	0.75	25%	75%	0%
2023	1.00		1.00	0%	100%	0%
2024	0.50		0.25	0%	50%	50%
		0.25	2.00	0.25		

Mitigated Emissions (grams per second) by Receptor Bin				grams by bin by year			grams/second by bin by year			QA Checks		
Source Group	Days of Construction	Grams of PM2.5 exhaust	avg grams per second	3rd tri	0<2	2<9	3rd tri	0<2	2<9			
Source Group 1	2022	259	6,930.8934	0.0008	1732.723	5188.170	0.000	0.0002	0.0006	0.0000	-	0.000000
	2023	260	3,764.8128	0.0004	0.000	3764.818	0.000	0.0000	0.0004	0.0000	-	0.000000
	2024	117	1,578.5019	0.0004	0.000	789.251	789.251	0.0000	0.0002	0.0002	-	0.000000
	Total	636			1732.723	9752.239	789.251	0.0002	0.0012	0.0002	-	
Source Group 2	2022	259	25.9142	0.0000229	6.479	19.436	0.000	0.0000	0.0000	0.0000	-	0.000000
	2023	260	0.8232	0.0000001	0.000	0.823	0.000	0.0000	0.0000	0.0000	-	0.000000
	2024	117	0.3799	0.0000001	0.000	0.190	0.190	0.0000	0.0000	0.0000	-	0.000000
	Total	636			6.479	20.449	0.190	0.0000	0.0000	0.0000	-	
Source Group 3	2022	259	518.8206	0.000586	129.705	389.115	0.000	0.0000	0.0000	0.0000	-	0.000000
	2023	260	16.4802	0.0000019	0.000	16.480	0.000	0.0000	0.0000	0.0000	-	0.000000
	2024	117	7.6062	0.0000019	0.000	3.803	3.803	0.0000	0.0000	0.0000	-	0.000000
	Total	636			129.705	409.399	3.803	0.0000	0.0000	0.0000	-	

Summary of Total Emissions - Unmitigated

Off-Road	Unmitigated	On-Site	Total							Metric tons per year			
			Tons per year							CO2	CH4	N2O	CO2e
Year	ROG	NOX	CO	PM10 E	PM2.5 E	PM10 D	PM2.5 D	SO2					
2022	0.19	1.75	1.83	0.08	0.0710	0.0356	0.004	0.00					
2023	0.16	1.32	1.87	0.06	0.0545	0.0000	0.000	0.00					
2024	0.06	0.52	0.78	0.02	0.0198	0.0000	0.000	0.00					
Total	0.42	3.59	4.48	0.15	0.1453	0.0356	0.004	0.01	0	0	0	0	

On-Road - Hauling	Unmitigated	Off-Site	Hauling							Metric tons per year			
			Tons per year							CO2	CH4	N2O	CO2e
Year	ROG	NOX	CO	PM10 E	PM2.5 E	PM10 D	PM2.5 D	SO2					
2022	0.02	0.61	0.13	0.01	0.0052	0.0595	0.016	0.00					
2023	0.00	0.00	0.00	0.00	0.0000	0.0000	0.000	0.00					
2024	0.00	0.00	0.00	0.00	0.0000	0.0000	0.000	0.00					
Total	0.02	0.61	0.13	0.01	0.0052	0.0595	0.016	0.00	0	0	0	0	

On-Road - Vendor	Unmitigated	Off-Site	Vendor							Metric tons per year			
			Tons per year							CO2	CH4	N2O	CO2e
Year	ROG	NOX	CO	PM10 E	PM2.5 E	PM10 D	PM2.5 D	SO2					
2022	0.01	0.22	0.06	0.00	0.0022	0.0255	0.007	0.00					
2023	0.00	0.02	0.01	0.00	0.0001	0.0034	0.001	0.00					
2024	0.00	0.01	0.00	0.00	0.0001	0.0017	0.000	0.00					
Total	0.01	0.25	0.07	0.00	0.0024	0.0306	0.009	0.00	0	0	0	0	

On-Road - Worker	Unmitigated	Off-Site	Worker							Metric tons per year			
			Tons per year							CO2	CH4	N2O	CO2e
Year	ROG	NOX	CO	PM10 E	PM2.5 E	PM10 D	PM2.5 D	SO2					
2022	0.04	0.03	0.36	0.00	0.0006	0.12	0.031	0.00					
2023	0.07	0.05	0.58	0.00	0.0009	0.21	0.055	0.00					
2024	0.03	0.02	0.27	0.00	0.0004	0.10	0.028	0.00					
Total	0.14	0.09	1.21	0.00	0.00	0.43	0.114	0.00	0	0	0	0	

Total	Unmitigated	Tons per year							Metric tons per year			
		ROG	NOX	CO	PM10 E	PM2.5 E	PM10 D	PM2.5 D	SO2	CO2	CH4	N2O
2022	0.2598	2.6067	2.3834	0.0839	0.0790	0.2386	0.0594	0.0089				
2023	0.2272	1.3906	2.4554	0.0577	0.0556	0.2096	0.0558	0.0047				
2024	0.0917	0.5520	1.0537	0.0212	0.0203	0.1055	0.0281	0.0021				
Total	1	5	6	0.16278	0.15488	1	0	0	0	0	0	0
QA	0.0000	0.0000	0.0002	(0.00003)	-	-0.0002	0.0000	0.0000				
	-0.0001	-0.0001	0.0000	(0.00006)	0.00003	0.0000	0.0000	0.0000				
	0.0000	0.0000	0.0001	0.00001	(0.00001)	0.0000	0.0000	0.0000				

DPM Exhaust	Source Group 1	Source Group 2	Source Group 3	Source Group 4	Source Group 5	Construction Days		fraction of year
						on-site	hauling	
2022	0.007	0.00000293	0.000059			259	259	0.71
2023	0.006	0.0000000	0.000002			260	260	0.71
2024	0.004	0.0000000	0.000002			117	117	0.32

Source Length	n/a	82.00	1,641.70	n/a	n/a
Haul Trip Length (meters)	n/a	32,187	32,187	n/a	n/a
Haul Scaling Factor	n/a	0.00	0.05	n/a	n/a
Vendor Trip Length (meters)	n/a	11,748	11,748	n/a	n/a
Vendor Scaling Factor	n/a	0.01	0.14	n/a	n/a
Worker Trip Length (meters)	n/a	17,381	17,381	n/a	n/a
Worker Scaling Factor	n/a	0.00	0.09	n/a	n/a

Summary of Total Emissions - Mitigated

Off-Road	Mitigated	On-Site	Total							Metric tons per year			
			Tons per year							CO2	CH4	N2O	CO2e
Year	ROG	NOX	CO	PM10 E	PM2.5 E	PM10 D	PM2.5 D	SO2					
2022	0.06	0.39	2.59	0.01	0.0076	0.0356	0.004	0.00					
2023	0.04	0.44	1.96	0.00	0.0042	0.0000	0.000	0.00					
2024	0.02	0.17	0.82	0.00	0.0017	0.0000	0.000	0.00					
Total	0.11	1.00	5.37	0.01	0.0135	0.0356	0.004	0.01	0	0	0	0	

On-Road - Hauling	Mitigated	Off-Site	Hauling							Metric tons per year			
			Tons per year							CO2	CH4	N2O	CO2e
Year	ROG	NOX	CO	PM10 E	PM2.5 E	PM10 D	PM2.5 D	SO2					
2022	0.02	0.61	0.13	0.01	0.0052	0.0595	0.016	0.00					
2023	0.00	0.00	0.00	0.00	0.0000	0.0000	0.000	0.00					
2024	0.00	0.00	0.00	0.00	0.0000	0.0000	0.000	0.00					
Total	0.02	0.61	0.13	0.01	0.0052	0.0595	0.016	0.00	0	0	0	0	

On-Road - Vendor	Mitigated	Off-Site	Vendor							Metric tons per year			
			Tons per year							CO2	CH4	N2O	CO2e
Year	ROG	NOX	CO	PM10 E	PM2.5 E	PM10 D	PM2.5 D	SO2					
2022	0.01	0.22	0.06	0.00	0.0022	0.0255	0.007	0.00					
2023	0.00	0.02	0.01	0.00	0.0001	0.0034	0.001	0.00					
2024	0.00	0.01	0.00	0.00	0.0001	0.0017	0.000	0.00					
Total	0.01	0.25	0.07	0.00	0.0024	0.0306	0.009	0.00	0	0	0	0	

On-Road - Worker	Mitigated	Off-Site	Worker							Metric tons per year			
			Tons per year							CO2	CH4	N2O	CO2e
Year	ROG	NOX	CO	PM10 E	PM2.5 E	PM10 D	PM2.5 D	SO2					
2022	0.04	0.03	0.36	0.00	0.0006	0.12	0.031	0.00					
2023	0.07	0.05	0.58	0.00	0.0009	0.21	0.055	0.00					
2024	0.03	0.02	0.27	0.00	0.0004	0.10	0.028	0.00					
Total	0.14	0.09	1.21	0.00	0.00	0.43	0.114	0.00	0	0	0	0	

Total	Mitigated	Tons per year							Metric tons per year			
		ROG	NOX	CO	PM10 E	PM2.5 E	PM10 D	PM2.5 D	SO2	CO2	CH4	N2O
2022	0.1256	1.2432	3.1426	0.0160	0.0156	0.2386	0.0594	0.0089				
2023	0.1041	0.5103	2.5475	0.0053	0.0052	0.2096	0.0558	0.0047				
2024	0.0466	0.1990	1.0966	0.0023	0.0022	0.1055	0.0281	0.0021				
Total	0	2	7	0.02362	0.02309	1	0	0	0	0	0	0
QA	0.1342	1.3635	-0.7590	0.06788	0.06337	-0.0002	0.0000	0.0000				
	0.1230	0.8802	-0.0921	0.05229	0.05038	0.0000	0.0000	0.0000				
	0.0451	0.3530	-0.0428	0.01891	0.01806	0.0000	0.0000	0.0000				

DPM Exhaust	Source Group 1	Source Group 2	Source Group 3	Source Group 4	Source Group 5	Construction Days		fraction of year
						on-site	hauling	
2022	0.001	0.00000293	0.000059			259	259	0.71
2023	0.000	0.0000000	0.000002			260	260	0.71
2024	0.000	0.0000000	0.000002			117	117	0.32

Source Length	n/a	82.00	1,641.70	n/a	n/a
Haul Trip Length (meters)	n/a	32,187	32,187	n/a	n/a
Haul Scaling Factor	n/a	0.00	0.05	n/a	n/a
Vendor Trip Length (meters)	n/a	11,748	11,748	n/a	n/a
Vendor Scaling Factor	n/a	0.01	0.14	n/a	n/a
Worker Trip Length (meters)	n/a	17,381	17,381	n/a	n/a
Worker Scaling Factor	n/a	0.00	0.09	n/a	n/a

Receptor Number	Unmitigated DPM Concentration (micrograms per cubic meter)			Mitigated DPM Concentration (micrograms per cubic meter)		
	2022	2023	2024	2022	2023	2024
Max	0.13	0.10	0.08	0.01	0.01	0.01
1	0.01	0.01	0.01	0.00	0.00	0.00
2	0.01	0.01	0.01	0.00	0.00	0.00
3	0.03	0.02	0.02	0.00	0.00	0.00
4	0.03	0.02	0.02	0.00	0.00	0.00
5	0.01	0.01	0.01	0.00	0.00	0.00
6	0.01	0.01	0.01	0.00	0.00	0.00
7	0.03	0.02	0.02	0.00	0.00	0.00
8	0.03	0.02	0.02	0.00	0.00	0.00
9	0.01	0.00	0.00	0.00	0.00	0.00
10	0.01	0.01	0.01	0.00	0.00	0.00
11	0.01	0.01	0.01	0.00	0.00	0.00
12	0.02	0.01	0.01	0.00	0.00	0.00
13	0.02	0.02	0.01	0.00	0.00	0.00
14	0.03	0.02	0.02	0.00	0.00	0.00
15	0.03	0.02	0.02	0.00	0.00	0.00
16	0.03	0.03	0.02	0.00	0.00	0.00
17	0.03	0.03	0.02	0.00	0.00	0.00
18	0.03	0.03	0.02	0.00	0.00	0.00
19	0.03	0.02	0.02	0.00	0.00	0.00
20	0.02	0.02	0.01	0.00	0.00	0.00
21	0.00	0.00	0.00	0.00	0.00	0.00
22	0.01	0.01	0.00	0.00	0.00	0.00
23	0.01	0.01	0.01	0.00	0.00	0.00
24	0.01	0.01	0.01	0.00	0.00	0.00
25	0.02	0.01	0.01	0.00	0.00	0.00
26	0.02	0.02	0.01	0.00	0.00	0.00
27	0.03	0.02	0.02	0.00	0.00	0.00
28	0.04	0.03	0.02	0.00	0.00	0.00
29	0.04	0.03	0.02	0.00	0.00	0.00
30	0.04	0.03	0.03	0.00	0.00	0.00
31	0.04	0.03	0.02	0.00	0.00	0.00
32	0.04	0.03	0.02	0.00	0.00	0.00
33	0.00	0.00	0.00	0.00	0.00	0.00
34	0.00	0.00	0.00	0.00	0.00	0.00
35	0.00	0.00	0.00	0.00	0.00	0.00
36	0.01	0.01	0.00	0.00	0.00	0.00
37	0.01	0.01	0.01	0.00	0.00	0.00
38	0.01	0.01	0.01	0.00	0.00	0.00
39	0.02	0.02	0.01	0.00	0.00	0.00
40	0.03	0.02	0.02	0.00	0.00	0.00
41	0.04	0.03	0.02	0.00	0.00	0.00
42	0.04	0.03	0.03	0.00	0.00	0.00
43	0.05	0.04	0.03	0.01	0.00	0.00
44	0.00	0.00	0.00	0.00	0.00	0.00
45	0.00	0.00	0.00	0.00	0.00	0.00
46	0.01	0.01	0.00	0.00	0.00	0.00
47	0.01	0.01	0.01	0.00	0.00	0.00
48	0.02	0.01	0.01	0.00	0.00	0.00
49	0.02	0.02	0.01	0.00	0.00	0.00
50	0.03	0.03	0.02	0.00	0.00	0.00
51	0.05	0.03	0.03	0.00	0.00	0.00
52	0.05	0.04	0.03	0.01	0.00	0.00
53	0.06	0.05	0.04	0.01	0.00	0.00
54	0.00	0.00	0.00	0.00	0.00	0.00
55	0.00	0.00	0.00	0.00	0.00	0.00
56	0.01	0.01	0.00	0.00	0.00	0.00
57	0.01	0.01	0.01	0.00	0.00	0.00
58	0.02	0.01	0.01	0.00	0.00	0.00
59	0.03	0.02	0.02	0.00	0.00	0.00
60	0.04	0.03	0.03	0.00	0.00	0.00
61	0.06	0.04	0.04	0.01	0.00	0.00
62	0.07	0.05	0.04	0.01	0.00	0.00
63	0.08	0.06	0.05	0.01	0.00	0.00
64	0.04	0.03	0.02	0.00	0.00	0.00
65	0.03	0.02	0.02	0.00	0.00	0.00
66	0.02	0.02	0.01	0.00	0.00	0.00
67	0.00	0.00	0.00	0.00	0.00	0.00
68	0.00	0.00	0.00	0.00	0.00	0.00
69	0.01	0.01	0.01	0.00	0.00	0.00
70	0.02	0.02	0.01	0.00	0.00	0.00
71	0.03	0.03	0.02	0.00	0.00	0.00
72	0.05	0.04	0.03	0.01	0.00	0.00
73	0.07	0.06	0.05	0.01	0.00	0.00
74	0.09	0.07	0.06	0.01	0.01	0.00
75	0.10	0.08	0.06	0.01	0.01	0.01

76	0.09	0.07	0.06	0.01	0.01	0.00
77	0.04	0.03	0.03	0.00	0.00	0.00
78	0.03	0.02	0.02	0.00	0.00	0.00
79	0.02	0.02	0.01	0.00	0.00	0.00
80	0.00	0.00	0.00	0.00	0.00	0.00
81	0.00	0.00	0.00	0.00	0.00	0.00
82	0.00	0.00	0.00	0.00	0.00	0.00
83	0.00	0.00	0.00	0.00	0.00	0.00
84	0.00	0.00	0.00	0.00	0.00	0.00
85	0.01	0.01	0.01	0.00	0.00	0.00
86	0.02	0.02	0.01	0.00	0.00	0.00
87	0.04	0.03	0.03	0.00	0.00	0.00
88	0.07	0.05	0.04	0.01	0.00	0.00
89	0.10	0.07	0.06	0.01	0.01	0.01
90	0.12	0.09	0.08	0.01	0.01	0.01
91	0.13	0.10	0.08	0.01	0.01	0.01
92	0.03	0.02	0.02	0.00	0.00	0.00
93	0.02	0.02	0.01	0.00	0.00	0.00
94	0.01	0.00	0.00	0.00	0.00	0.00
95	0.00	0.00	0.00	0.00	0.00	0.00
96	0.00	0.00	0.00	0.00	0.00	0.00
97	0.00	0.00	0.00	0.00	0.00	0.00
98	0.00	0.00	0.00	0.00	0.00	0.00
99	0.00	0.00	0.00	0.00	0.00	0.00
100	0.00	0.00	0.00	0.00	0.00	0.00
101	0.00	0.00	0.00	0.00	0.00	0.00
102	0.00	0.00	0.00	0.00	0.00	0.00
103	0.00	0.00	0.00	0.00	0.00	0.00
104	0.00	0.00	0.00	0.00	0.00	0.00
105	0.00	0.00	0.00	0.00	0.00	0.00
106	0.03	0.02	0.02	0.00	0.00	0.00
107	0.05	0.04	0.03	0.01	0.00	0.00
108	0.03	0.02	0.02	0.00	0.00	0.00
109	0.01	0.00	0.00	0.00	0.00	0.00
110	0.00	0.00	0.00	0.00	0.00	0.00
111	0.00	0.00	0.00	0.00	0.00	0.00
112	0.00	0.00	0.00	0.00	0.00	0.00
113	0.00	0.00	0.00	0.00	0.00	0.00
114	0.00	0.00	0.00	0.00	0.00	0.00
115	0.00	0.00	0.00	0.00	0.00	0.00
116	0.00	0.00	0.00	0.00	0.00	0.00
117	0.00	0.00	0.00	0.00	0.00	0.00
118	0.00	0.00	0.00	0.00	0.00	0.00
119	0.00	0.00	0.00	0.00	0.00	0.00
120	0.00	0.00	0.00	0.00	0.00	0.00
121	0.01	0.01	0.00	0.00	0.00	0.00
122	0.01	0.00	0.00	0.00	0.00	0.00
123	0.00	0.00	0.00	0.00	0.00	0.00
124	0.00	0.00	0.00	0.00	0.00	0.00
125	0.00	0.00	0.00	0.00	0.00	0.00
126	0.00	0.00	0.00	0.00	0.00	0.00
127	0.00	0.00	0.00	0.00	0.00	0.00
128	0.00	0.00	0.00	0.00	0.00	0.00
129	0.00	0.00	0.00	0.00	0.00	0.00
130	0.00	0.00	0.00	0.00	0.00	0.00
131	0.00	0.00	0.00	0.00	0.00	0.00
132	0.00	0.00	0.00	0.00	0.00	0.00
133	0.00	0.00	0.00	0.00	0.00	0.00
134	0.00	0.00	0.00	0.00	0.00	0.00
135	0.01	0.00	0.00	0.00	0.00	0.00
136	0.01	0.01	0.01	0.00	0.00	0.00
137	0.01	0.01	0.00	0.00	0.00	0.00
138	0.01	0.00	0.00	0.00	0.00	0.00
139	0.00	0.00	0.00	0.00	0.00	0.00
140	0.00	0.00	0.00	0.00	0.00	0.00
141	0.00	0.00	0.00	0.00	0.00	0.00
142	0.00	0.00	0.00	0.00	0.00	0.00
143	0.00	0.00	0.00	0.00	0.00	0.00
144	0.00	0.00	0.00	0.00	0.00	0.00
145	0.00	0.00	0.00	0.00	0.00	0.00
146	0.00	0.00	0.00	0.00	0.00	0.00
147	0.00	0.00	0.00	0.00	0.00	0.00
148	0.00	0.00	0.00	0.00	0.00	0.00
149	0.00	0.00	0.00	0.00	0.00	0.00
150	0.00	0.00	0.00	0.00	0.00	0.00
151	0.01	0.00	0.00	0.00	0.00	0.00
152	0.01	0.01	0.01	0.00	0.00	0.00
153	0.01	0.01	0.00	0.00	0.00	0.00

232	0.04	0.03	0.02	0.00	0.00	0.00
233	0.02	0.02	0.01	0.00	0.00	0.00
234	0.02	0.01	0.01	0.00	0.00	0.00
235	0.01	0.01	0.01	0.00	0.00	0.00
236	0.01	0.01	0.01	0.00	0.00	0.00
237	0.01	0.01	0.01	0.00	0.00	0.00
238	0.01	0.01	0.00	0.00	0.00	0.00
239	0.01	0.00	0.00	0.00	0.00	0.00
240	0.00	0.00	0.00	0.00	0.00	0.00
241	0.00	0.00	0.00	0.00	0.00	0.00
242	0.00	0.00	0.00	0.00	0.00	0.00
243	0.00	0.00	0.00	0.00	0.00	0.00
244	0.00	0.00	0.00	0.00	0.00	0.00
245	0.00	0.00	0.00	0.00	0.00	0.00
246	0.00	0.00	0.00	0.00	0.00	0.00
247	0.00	0.00	0.00	0.00	0.00	0.00
248	0.00	0.00	0.00	0.00	0.00	0.00
249	0.00	0.00	0.00	0.00	0.00	0.00
250	0.00	0.00	0.00	0.00	0.00	0.00
251	0.00	0.00	0.00	0.00	0.00	0.00
252	0.01	0.00	0.00	0.00	0.00	0.00
253	0.01	0.01	0.01	0.00	0.00	0.00
254	0.04	0.03	0.03	0.01	0.00	0.00
255	0.03	0.02	0.02	0.00	0.00	0.00
256	0.02	0.01	0.01	0.00	0.00	0.00
257	0.01	0.01	0.01	0.00	0.00	0.00
258	0.01	0.01	0.01	0.00	0.00	0.00
259	0.01	0.01	0.01	0.00	0.00	0.00
260	0.01	0.01	0.00	0.00	0.00	0.00
261	0.01	0.01	0.00	0.00	0.00	0.00
262	0.01	0.00	0.00	0.00	0.00	0.00
263	0.00	0.00	0.00	0.00	0.00	0.00
264	0.00	0.00	0.00	0.00	0.00	0.00
265	0.00	0.00	0.00	0.00	0.00	0.00
266	0.00	0.00	0.00	0.00	0.00	0.00
267	0.00	0.00	0.00	0.00	0.00	0.00
268	0.00	0.00	0.00	0.00	0.00	0.00
269	0.00	0.00	0.00	0.00	0.00	0.00
270	0.00	0.00	0.00	0.00	0.00	0.00
271	0.00	0.00	0.00	0.00	0.00	0.00
272	0.00	0.00	0.00	0.00	0.00	0.00
273	0.00	0.00	0.00	0.00	0.00	0.00
274	0.00	0.00	0.00	0.00	0.00	0.00
275	0.01	0.00	0.00	0.00	0.00	0.00
276	0.01	0.01	0.00	0.00	0.00	0.00
277	0.01	0.01	0.01	0.00	0.00	0.00
278	0.01	0.01	0.01	0.00	0.00	0.00
279	0.03	0.02	0.02	0.00	0.00	0.00
280	0.03	0.03	0.02	0.00	0.00	0.00
281	0.02	0.01	0.01	0.00	0.00	0.00
282	0.01	0.01	0.01	0.00	0.00	0.00
283	0.01	0.01	0.01	0.00	0.00	0.00
284	0.01	0.01	0.00	0.00	0.00	0.00
285	0.01	0.01	0.00	0.00	0.00	0.00
286	0.01	0.00	0.00	0.00	0.00	0.00
287	0.01	0.00	0.00	0.00	0.00	0.00
288	0.00	0.00	0.00	0.00	0.00	0.00
289	0.00	0.00	0.00	0.00	0.00	0.00
290	0.00	0.00	0.00	0.00	0.00	0.00
291	0.00	0.00	0.00	0.00	0.00	0.00
292	0.00	0.00	0.00	0.00	0.00	0.00
293	0.00	0.00	0.00	0.00	0.00	0.00
294	0.00	0.00	0.00	0.00	0.00	0.00
295	0.00	0.00	0.00	0.00	0.00	0.00
296	0.00	0.00	0.00	0.00	0.00	0.00
297	0.00	0.00	0.00	0.00	0.00	0.00
298	0.00	0.00	0.00	0.00	0.00	0.00
299	0.00	0.00	0.00	0.00	0.00	0.00
300	0.00	0.00	0.00	0.00	0.00	0.00
301	0.01	0.00	0.00	0.00	0.00	0.00
302	0.01	0.01	0.00	0.00	0.00	0.00
303	0.01	0.01	0.01	0.00	0.00	0.00
304	0.01	0.01	0.01	0.00	0.00	0.00
305	0.02	0.01	0.01	0.00	0.00	0.00
306	0.02	0.01	0.01	0.00	0.00	0.00
307	0.02	0.02	0.01	0.00	0.00	0.00
308	0.02	0.02	0.01	0.00	0.00	0.00
309	0.02	0.01	0.01	0.00	0.00	0.00

Non-DPM PM2.5 Concentrations (On-site Grading; Truck Hauling and Worker Commute Vehicles on California Street and San Antonio Road)

Truck Dust Concentrations Receptor Number		Unmitigated DPM Concentration (micrograms per cubic meter)			Mitigated DPM Concentration (micrograms per cubic meter)		
		2022	2023	2024	2022	2023	2024
Max		0.00	0.00	0.00	0.00	0.00	0.00
	1	0.00	0.00	0.00	0.00	0.00	0.00
	2	0.00	0.00	0.00	0.00	0.00	0.00
	3	0.00	0.00	0.00	0.00	0.00	0.00
	4	0.00	0.00	0.00	0.00	0.00	0.00
	5	0.00	0.00	0.00	0.00	0.00	0.00
	6	0.00	0.00	0.00	0.00	0.00	0.00
	7	0.00	0.00	0.00	0.00	0.00	0.00
	8	0.00	0.00	0.00	0.00	0.00	0.00
	9	0.00	0.00	0.00	0.00	0.00	0.00
	10	0.00	0.00	0.00	0.00	0.00	0.00
	11	0.00	0.00	0.00	0.00	0.00	0.00
	12	0.00	0.00	0.00	0.00	0.00	0.00
	13	0.00	0.00	0.00	0.00	0.00	0.00
	14	0.00	0.00	0.00	0.00	0.00	0.00
	15	0.00	0.00	0.00	0.00	0.00	0.00
	16	0.00	0.00	0.00	0.00	0.00	0.00
	17	0.00	0.00	0.00	0.00	0.00	0.00
	18	0.00	0.00	0.00	0.00	0.00	0.00
	19	0.00	0.00	0.00	0.00	0.00	0.00
	20	0.00	0.00	0.00	0.00	0.00	0.00
	21	0.00	0.00	0.00	0.00	0.00	0.00
	22	0.00	0.00	0.00	0.00	0.00	0.00
	23	0.00	0.00	0.00	0.00	0.00	0.00
	24	0.00	0.00	0.00	0.00	0.00	0.00
	25	0.00	0.00	0.00	0.00	0.00	0.00
	26	0.00	0.00	0.00	0.00	0.00	0.00
	27	0.00	0.00	0.00	0.00	0.00	0.00
	28	0.00	0.00	0.00	0.00	0.00	0.00
	29	0.00	0.00	0.00	0.00	0.00	0.00
	30	0.00	0.00	0.00	0.00	0.00	0.00
	31	0.00	0.00	0.00	0.00	0.00	0.00
	32	0.00	0.00	0.00	0.00	0.00	0.00
	33	0.00	0.00	0.00	0.00	0.00	0.00
	34	0.00	0.00	0.00	0.00	0.00	0.00
	35	0.00	0.00	0.00	0.00	0.00	0.00
	36	0.00	0.00	0.00	0.00	0.00	0.00
	37	0.00	0.00	0.00	0.00	0.00	0.00
	38	0.00	0.00	0.00	0.00	0.00	0.00
	39	0.00	0.00	0.00	0.00	0.00	0.00
	40	0.00	0.00	0.00	0.00	0.00	0.00
	41	0.00	0.00	0.00	0.00	0.00	0.00
	42	0.00	0.00	0.00	0.00	0.00	0.00
	43	0.00	0.00	0.00	0.00	0.00	0.00
	44	0.00	0.00	0.00	0.00	0.00	0.00
	45	0.00	0.00	0.00	0.00	0.00	0.00
	46	0.00	0.00	0.00	0.00	0.00	0.00
	47	0.00	0.00	0.00	0.00	0.00	0.00
	48	0.00	0.00	0.00	0.00	0.00	0.00
	49	0.00	0.00	0.00	0.00	0.00	0.00
	50	0.00	0.00	0.00	0.00	0.00	0.00
	51	0.00	0.00	0.00	0.00	0.00	0.00
	52	0.00	0.00	0.00	0.00	0.00	0.00
	53	0.00	0.00	0.00	0.00	0.00	0.00
	54	0.00	0.00	0.00	0.00	0.00	0.00
	55	0.00	0.00	0.00	0.00	0.00	0.00
	56	0.00	0.00	0.00	0.00	0.00	0.00
	57	0.00	0.00	0.00	0.00	0.00	0.00
	58	0.00	0.00	0.00	0.00	0.00	0.00
	59	0.00	0.00	0.00	0.00	0.00	0.00
	60	0.00	0.00	0.00	0.00	0.00	0.00
	61	0.00	0.00	0.00	0.00	0.00	0.00
	62	0.00	0.00	0.00	0.00	0.00	0.00
	63	0.00	0.00	0.00	0.00	0.00	0.00
	64	0.00	0.00	0.00	0.00	0.00	0.00
	65	0.00	0.00	0.00	0.00	0.00	0.00
	66	0.00	0.00	0.00	0.00	0.00	0.00
	67	0.00	0.00	0.00	0.00	0.00	0.00
	68	0.00	0.00	0.00	0.00	0.00	0.00
	69	0.00	0.00	0.00	0.00	0.00	0.00
	70	0.00	0.00	0.00	0.00	0.00	0.00
	71	0.00	0.00	0.00	0.00	0.00	0.00
	72	0.00	0.00	0.00	0.00	0.00	0.00
	73	0.00	0.00	0.00	0.00	0.00	0.00
	74	0.00	0.00	0.00	0.00	0.00	0.00
	75	0.00	0.00	0.00	0.00	0.00	0.00

Site Grading and Worker Commute
Vehicles (Exhaust and Dust)

Receptor Number
Max

Unmitigated Dust Concentration (micrograms per cubic meter)

Mitigated Dust Concentration (micrograms per cubic meter)

	2022	2023	2024	2022	2023	2024
1	0.01	0.01	0.01	0.01	0.01	0.01
2	0.00	0.00	0.00	0.00	0.00	0.00
3	0.00	0.00	0.00	0.00	0.00	0.00
4	0.00	0.00	0.00	0.00	0.00	0.00
5	0.00	0.00	0.00	0.00	0.00	0.00
6	0.00	0.00	0.00	0.00	0.00	0.00
7	0.00	0.00	0.00	0.00	0.00	0.00
8	0.00	0.00	0.00	0.00	0.00	0.00
9	0.00	0.00	0.00	0.00	0.00	0.00
10	0.00	0.00	0.00	0.00	0.00	0.00
11	0.00	0.00	0.00	0.00	0.00	0.00
12	0.00	0.00	0.00	0.00	0.00	0.00
13	0.00	0.00	0.00	0.00	0.00	0.00
14	0.00	0.00	0.00	0.00	0.00	0.00
15	0.00	0.00	0.00	0.00	0.00	0.00
16	0.00	0.00	0.00	0.00	0.00	0.00
17	0.00	0.00	0.00	0.00	0.00	0.00
18	0.00	0.00	0.00	0.00	0.00	0.00
19	0.00	0.00	0.00	0.00	0.00	0.00
20	0.00	0.00	0.00	0.00	0.00	0.00
21	0.00	0.00	0.00	0.00	0.00	0.00
22	0.00	0.00	0.00	0.00	0.00	0.00
23	0.00	0.00	0.00	0.00	0.00	0.00
24	0.00	0.00	0.00	0.00	0.00	0.00
25	0.00	0.00	0.00	0.00	0.00	0.00
26	0.00	0.00	0.00	0.00	0.00	0.00
27	0.00	0.00	0.00	0.00	0.00	0.00
28	0.00	0.00	0.00	0.00	0.00	0.00
29	0.00	0.00	0.00	0.00	0.00	0.00
30	0.00	0.00	0.00	0.00	0.00	0.00
31	0.00	0.00	0.00	0.00	0.00	0.00
32	0.00	0.00	0.00	0.00	0.00	0.00
33	0.00	0.00	0.00	0.00	0.00	0.00
34	0.00	0.00	0.00	0.00	0.00	0.00
35	0.00	0.00	0.00	0.00	0.00	0.00
36	0.00	0.00	0.00	0.00	0.00	0.00
37	0.00	0.00	0.00	0.00	0.00	0.00
38	0.00	0.00	0.00	0.00	0.00	0.00
39	0.00	0.00	0.00	0.00	0.00	0.00
40	0.00	0.00	0.00	0.00	0.00	0.00
41	0.00	0.00	0.00	0.00	0.00	0.00
42	0.00	0.00	0.00	0.00	0.00	0.00
43	0.00	0.00	0.00	0.00	0.00	0.00
44	0.00	0.00	0.00	0.00	0.00	0.00
45	0.00	0.00	0.00	0.00	0.00	0.00
46	0.00	0.00	0.00	0.00	0.00	0.00
47	0.00	0.00	0.00	0.00	0.00	0.00
48	0.00	0.00	0.00	0.00	0.00	0.00
49	0.00	0.00	0.00	0.00	0.00	0.00
50	0.00	0.00	0.00	0.00	0.00	0.00
51	0.00	0.00	0.00	0.00	0.00	0.00
52	0.00	0.00	0.00	0.00	0.00	0.00
53	0.00	0.00	0.00	0.00	0.00	0.00
54	0.00	0.00	0.00	0.00	0.00	0.00
55	0.00	0.00	0.00	0.00	0.00	0.00
56	0.00	0.00	0.00	0.00	0.00	0.00
57	0.00	0.00	0.00	0.00	0.00	0.00
58	0.00	0.00	0.00	0.00	0.00	0.00
59	0.00	0.00	0.00	0.00	0.00	0.00
60	0.00	0.00	0.00	0.00	0.00	0.00
61	0.00	0.00	0.00	0.00	0.00	0.00
62	0.00	0.00	0.00	0.00	0.00	0.00
63	0.01	0.00	0.00	0.01	0.00	0.00
64	0.00	0.00	0.00	0.00	0.00	0.00
65	0.00	0.00	0.00	0.00	0.00	0.00
66	0.00	0.00	0.00	0.00	0.00	0.00
67	0.00	0.00	0.00	0.00	0.00	0.00
68	0.00	0.00	0.00	0.00	0.00	0.00
69	0.00	0.00	0.00	0.00	0.00	0.00
70	0.00	0.00	0.00	0.00	0.00	0.00
71	0.00	0.00	0.00	0.00	0.00	0.00
72	0.00	0.00	0.00	0.00	0.00	0.00
73	0.01	0.00	0.00	0.01	0.00	0.00
74	0.01	0.00	0.00	0.01	0.00	0.00
75	0.01	0.00	0.00	0.01	0.00	0.00
76	0.01	0.00	0.00	0.01	0.00	0.00
77	0.00	0.00	0.00	0.00	0.00	0.00
78	0.00	0.00	0.00	0.00	0.00	0.00
79	0.00	0.00	0.00	0.00	0.00	0.00

412	0.00	0.00	0.00	0.00	0.00	0.00
413	0.00	0.00	0.00	0.00	0.00	0.00
414	0.00	0.00	0.00	0.00	0.00	0.00
415	0.00	0.00	0.00	0.00	0.00	0.00
416	0.00	0.00	0.00	0.00	0.00	0.00
417	0.00	0.00	0.00	0.00	0.00	0.00
418	0.00	0.00	0.00	0.00	0.00	0.00
419	0.00	0.00	0.00	0.00	0.00	0.00
420	0.00	0.00	0.00	0.00	0.00	0.00
421	0.00	0.00	0.00	0.00	0.00	0.00
422	0.00	0.00	0.00	0.00	0.00	0.00
423	0.00	0.00	0.00	0.00	0.00	0.00
424	0.00	0.00	0.00	0.00	0.00	0.00
425	0.00	0.00	0.00	0.00	0.00	0.00
426	0.00	0.00	0.00	0.00	0.00	0.00
427	0.00	0.00	0.00	0.00	0.00	0.00
428	0.00	0.00	0.00	0.00	0.00	0.00
429	0.00	0.00	0.00	0.00	0.00	0.00
430	0.00	0.00	0.00	0.00	0.00	0.00
431	0.00	0.00	0.00	0.00	0.00	0.00
432	0.00	0.00	0.00	0.00	0.00	0.00
433	0.00	0.00	0.00	0.00	0.00	0.00
434	0.00	0.00	0.00	0.00	0.00	0.00
435	0.00	0.00	0.00	0.00	0.00	0.00
436	0.00	0.00	0.00	0.00	0.00	0.00
437	0.00	0.00	0.00	0.00	0.00	0.00
438	0.00	0.00	0.00	0.00	0.00	0.00
439	0.00	0.00	0.00	0.00	0.00	0.00
440	0.00	0.00	0.00	0.00	0.00	0.00
441	0.00	0.00	0.00	0.00	0.00	0.00
442	0.00	0.00	0.00	0.00	0.00	0.00
443	0.00	0.00	0.00	0.00	0.00	0.00
444	0.00	0.00	0.00	0.00	0.00	0.00
445	0.00	0.00	0.00	0.00	0.00	0.00
446	0.00	0.00	0.00	0.00	0.00	0.00
447	0.00	0.00	0.00	0.00	0.00	0.00
448	0.00	0.00	0.00	0.00	0.00	0.00
449	0.01	0.01	0.01	0.01	0.01	0.01
450	0.01	0.01	0.01	0.01	0.01	0.01
451	0.01	0.01	0.01	0.01	0.01	0.01
452	0.01	0.01	0.01	0.01	0.01	0.01
453	0.01	0.01	0.01	0.01	0.01	0.01
454	0.01	0.01	0.01	0.01	0.01	0.01
455	0.01	0.01	0.01	0.01	0.01	0.01
456	0.01	0.00	0.00	0.01	0.00	0.00
457	0.01	0.00	0.00	0.01	0.00	0.00

BAAQMD Cumulative Data

BAAQMD Cumulative Data - Roadways and Rail

FID	Name	railpm25	railcan	majstrpm25	majstrcanc	highpm25	highcancer	road_pm25	road_cance	X	Y
0	Receptor 1	0.0197875	10.2894001	0.72983098	33.94900131	0.178941995	8.180210114	0.908772945	42.12921143	578816.1119	4140069.804
1	Receptor 2	0.0206577	10.74190044	0.358922988	16.69519997	0.179492995	8.190629959	0.538415968	24.88582993	578891.1119	4140039.805

Gas Station

Distance (meters)	Distance (feet)	Distance adjustment multiplier	Enter Risk or Hazard	Adjusted Risk or Hazard
0	0.0	1.000		0.0000
5	16.4	1.000		0.0000
10	32.8	1.000		0.0000
15	49.2	1.000		0.0000
20	65.6	1.000		0.0000
25	82.0	0.728		0.0000
30	98.4	0.559		0.0000
35	114.8	0.445		0.0000
40	131.2	0.365		0.0000
45	147.6	0.305		0.0000
50	164.0	0.260		0.0000
55	180.4	0.225		0.0000
60	196.9	0.197	15.28	3.0031
65	213.3	0.174		0.0000
70	229.7	0.155		0.0000
75	246.1	0.139		0.0000
80	262.5	0.126		0.0000
85	278.9	0.114		0.0000
90	295.3	0.104		0.0000
95	311.7	0.096		0.0000
100	328.1	0.088		0.0000
105	344.5	0.082		0.0000
110	360.9	0.076		0.0000
115	377.3	0.071		0.0000
120	393.7	0.066		0.0000
125	410.1	0.062		0.0000
130	426.5	0.058		0.0000
135	442.9	0.055		0.0000
140	459.3	0.052		0.0000
145	475.7	0.049		0.0000
150	492.1	0.046		0.0000
155	508.5	0.044		0.0000
160	524.9	0.042		0.0000
165	541.3	0.040		0.0000
170	557.7	0.038		0.0000
175	574.1	0.036		0.0000
180	590.6	0.034		0.0000
185	607.0	0.033		0.0000
190	623.4	0.031		0.0000
195	639.8	0.030		0.0000

200	656.2	0.029		0.0000
205	672.6	0.028		0.0000
210	689.0	0.027		0.0000
215	705.4	0.026		0.0000
220	721.8	0.025		0.0000
225	738.2	0.024		0.0000
230	754.6	0.023		0.0000
235	771.0	0.022		0.0000
240	787.4	0.022		0.0000
245	803.8	0.021		0.0000
250	820.2	0.020		0.0000
255	836.6	0.020		0.0000
260	853.0	0.019		0.0000
265	869.4	0.018		0.0000
270	885.8	0.018		0.0000
275	902.2	0.017		0.0000
280	918.6	0.017		0.0000
285	935.0	0.016		0.0000
290	951.4	0.016		0.0000
295	967.8	0.015		0.0000
300	984.3	0.015		0.0000

Gasoline Dispensing Facility (GDF) Distance Multiplier Tool: This distance multiplier tool refines the screening values for cancer risk and chronic hazard index found in the District's Stationary Source Screening Analysis Tool for GDF's, to represent adjusted risk and hazard impacts that can be expected with farther distances from the source of emissions.

Gas Station

Distance (meters)	Distance (feet)	Distance adjustment multiplier	Enter Risk or Hazard	Adjusted Risk or Hazard
0	0.0	1.000		0.0000
5	16.4	1.000		0.0000
10	32.8	1.000		0.0000
15	49.2	1.000		0.0000
20	65.6	1.000		0.0000
25	82.0	0.728		0.0000
30	98.4	0.559		0.0000
35	114.8	0.445		0.0000
40	131.2	0.365		0.0000
45	147.6	0.305		0.0000
50	164.0	0.260		0.0000
55	180.4	0.225		0.0000
60	196.9	0.197	0.07	0.0138
65	213.3	0.174		0.0000
70	229.7	0.155		0.0000
75	246.1	0.139		0.0000
80	262.5	0.126		0.0000
85	278.9	0.114		0.0000
90	295.3	0.104		0.0000
95	311.7	0.096		0.0000
100	328.1	0.088		0.0000
105	344.5	0.082		0.0000
110	360.9	0.076		0.0000
115	377.3	0.071		0.0000
120	393.7	0.066		0.0000
125	410.1	0.062		0.0000
130	426.5	0.058		0.0000
135	442.9	0.055		0.0000
140	459.3	0.052		0.0000
145	475.7	0.049		0.0000
150	492.1	0.046		0.0000
155	508.5	0.044		0.0000
160	524.9	0.042		0.0000

165	541.3	0.040		0.0000
170	557.7	0.038		0.0000
175	574.1	0.036		0.0000
180	590.6	0.034		0.0000
185	607.0	0.033		0.0000
190	623.4	0.031		0.0000
195	639.8	0.030		0.0000
200	656.2	0.029		0.0000
205	672.6	0.028		0.0000
210	689.0	0.027		0.0000
215	705.4	0.026		0.0000
220	721.8	0.025		0.0000
225	738.2	0.024		0.0000
230	754.6	0.023		0.0000
235	771.0	0.022		0.0000
240	787.4	0.022		0.0000
245	803.8	0.021		0.0000
250	820.2	0.020		0.0000
255	836.6	0.020		0.0000
260	853.0	0.019		0.0000
265	869.4	0.018		0.0000
270	885.8	0.018		0.0000
275	902.2	0.017		0.0000
280	918.6	0.017		0.0000
285	935.0	0.016		0.0000
290	951.4	0.016		0.0000
295	967.8	0.015		0.0000
300	984.3	0.015		0.0000

Appendix B
DPR Forms

P1. Other Identifier: Eaves Mountain View at Middlefield Apartments

*P2. Location: Not for Publication Unrestricted *a. County Santa Clara County

And (P2b and P2c or P2d. Attach a Location Map as necessary.)

*b. USGS 7.5' Quad Mountain View Date 2018 T; R; of Sec ____; B.M.

c. Address: 365 San Antonio Road City Mountain View Zip 94040

d. UTM: (give more than one for large and/or linear resources) Zone 10 S; 578706.49 m E/4140198.74 m N

e. Other Locational Data: (e.g., parcel #, directions to resource, elevation, etc., as appropriate) APN: 148-22-005

*P3a. Description: (Describe resource and its major elements. Include design, materials, condition, alterations, size, setting, and boundaries)

The property at 365 San Antonio Road contains a one-story commercial building with a rectangular plan situated on a parcel measuring approximately 60 feet wide by 160 feet deep. The building faces west, toward San Antonio Road; a service drive runs adjacent to the south edge of the parcel. The parcel features surface paving along the building's primary (west), south, and rear (east) façades; the rear paved area provides vehicular parking. The adjoining parcel to the north also contains a paved surface parking lot. The building's general setting is a commercial corridor in western Mountain View. Low-scale (one-story) development lies north of the subject building, while taller (up to five-story) residential and commercial complexes lie to the south and west.

(See continuation sheet.)

*P3b. Resource Attributes: (List attributes and codes) HP6 (1- to 3-story commercial building)

*P4. Resources Present: Building Structure Object Site District Element of District Other

P5a. Photograph or Drawing (Photograph required for buildings, structures and objects)



Figure 1: 365 San Antonio Road, viewed facing east. Source: ICF.

P5b. Description of Photo: (View, date, accession #) View facing east, 3/29/2021

*P6. Date Constructed/Age and Sources:
 Historic Prehistoric Both
1952 (Assessor's Records)

*P7. Owner and Address:
MGP IX SAC MP&P, LLC
425 California Street, Floor 10
San Francisco, CA 94104

*P8. Recorded by: (Name, affiliation, address)
Jon Rusch, ICF
201 Mission Street, Suite 1500
San Francisco, CA 94105

*P9. Date Recorded: March 29, 2021

*P10. Survey Type: (Describe) Intensive

*P11. Report Citation: ICF. 2021. *The Village at San Antonio – Phase III*. Addendum. Date pending. (ICF 00693.20.) San Francisco, CA. Prepared for City of Mountain View, Mountain View, CA

*Attachments: NONE Location Map Sketch Map Continuation Sheet Building, Structure, and Object Record Archaeological Record
 District Record Linear Feature Record Milling Station Record Rock Art Record Artifact Record Photograph Record

BUILDING, STRUCTURE, AND OBJECT RECORD

Page 2 of 7

*NRHP Status Code 6Z

*Resource Name or # (Assigned by recorder) 365 San Antonio Road

B1. Historic Name: Unknown

B2. Common Name: PerceptiMed

B3. Original Use: Commercial (most likely retail)

B4. Present Use: Commercial office

*B5. Architectural Style: No discernible style (altered)

*B6. Construction History: (Construction date, alteration, and date of alterations)

The building at 365 San Antonio Road in Mountain View, California, was constructed in 1952, according to Santa Clara County Assessor's Office data (ParcelQuest 2021). However, the building's original architect and builder remain unidentified. A review of historic aerial photographs revealed that an addition was constructed on the north side of the building between 1960 and 1968, but the addition was demolished between 1987 and 1991 (Nationwide Environmental Title Research [NETR] 1960, 1968, 1987, 1991). Summaries of four building permits issued between 2000 and 2019 are available on the City of Mountain View website; these permits indicate minor scopes of work, including interior tenant improvements and the installation of an illuminated tenant identification sign that appears to be no longer extant (City of Mountain View 2021). Based on visual inspection, the building's exterior cladding, corrugated metal frieze, and most window and door configurations do not appear to be original. These alterations remain undated.

*B7. Moved? No Yes Unknown Date: N/A

Original Location: N/A

*B8. Related Features: N/A

B9a. Architect: Unknown

b. Builder: Unknown

*B10. Significance: Theme N/A

Area N/A

Period of Significance N/A

Property Type N/A

Applicable Criteria N/A

(Discuss importance in terms of historical or architectural context as defined by theme, period, and geographic scope. Also address integrity.)

Historic Context: Mountain View

Prior to the arrival of European explorers and settlers in the 1760s and 1770s, the Santa Clara Valley's primary inhabitants were the Ohlone people. Spanish missions became the first European settlements in the area during the final quarter of the 18th century. Over the next 100 years, waves of European-American settlers arrived in the region as a result of the 1848 California Gold Rush and subsequent railroad developments; they, in turn, established new farms, residences, and community nodes. (LSA Associates, Inc. 2011:450–451).

(See continuation sheet.)

B11. Additional Resource Attributes: (List attributes and codes)

*B12. References: (See continuation sheet.)

B13. Remarks: N/A

*B14. Evaluator: Jon Rusch, ICF

*Date of Evaluation: 7/9/2021

(This space reserved for official comments.)



Page 3 of 7

*Resource Name or #(Assigned by recorder) 365 San Antonio Road

*Recorded by Jon Rusch, ICF

*Date July 9, 2021

Continuation Update

***P3a. Description (continued):**

The building's low-slope barrel roof is set behind a parapet formed by a non-original corrugated metal frieze on all façades. The primary façade (Figure 2) features the building's centered primary entrance, which is flanked by structural piers. The entrance comprises a pairing of fully glazed, metal-framed pedestrian doors under a large, fixed transom that bears the building's address. The façade features tile cladding on both sides of the entrance. The tiles appear to be ceramic but are finished to have the appearance of stone. At either end of the façade is a band of three large, vertically oriented fixed windows. These windows, which rise between the foundation level and the corrugated metal frieze, are separated by metal mullions. The glazing at the entrance and in the window bands is reflective glass. Tile-clad piers form the outermost ends of the façade.

The remaining façades of the building are clad primarily in stucco below the corrugated metal frieze. The south façade (Figure 3) is divided by structural piers; each exterior pier face is clad with the same tile found at the primary façade. The south façade also has an irregular arrangement of windows, including a non-original fixed picture window near the façade's west end, two small windows near the center, and an original multi-lite, steel-sash window close to the façade's east end. The rear façade (Figure 4) has an arrangement similar to that of the primary façade, although the entrance is off-center, and only one area of tile cladding is present. In addition, a glazed pedestrian door is incorporated into the window grouping at the south end of the façade. A small non-original shed-roofed storage shed projects from the façade's north end. The north façade (Figure 5) is articulated by exposed concrete structural columns but has no other distinguishing features.

***B10. Significance (continued):**

Mountain View was a 19th-century stagecoach stop along El Camino Real, the route that connected California's missions. The community grew as the Santa Clara Valley gained prominence as an agricultural production center during the late 19th century. The town incorporated in 1902 with fewer than 1,000 residents. The agricultural and horticultural economy that had sustained Mountain View remained strong until World War II, at which point the ascendance of new technology, as well as the electronics industries in the region, shifted the focus.

Following World War II, an influx of new residents spurred suburban tract residential development across the valley's formerly agricultural lands. Moffett Federal Airfield, the Lockheed Missile and Space Company, and the NASA Ames Research Center all contributed to the early growth in the high-tech industries that took hold around Mountain View and ultimately led to the region's christening as "Silicon Valley." Like many small communities on the San Francisco Peninsula and in the Santa Clara Valley in the mid-20th century, Mountain View experienced enormous population growth, with just under 4,000 residents in 1940 but more than 30,000 by 1960. These trends continued and even accelerated in subsequent decades, fueled by the ascendance of industries associated with the personal computer and further land development associated with the region's commercial and technology sectors (LSA Associates, Inc. 2011:451-453).

Site History

Prior to construction of the building at 365 San Antonio Road in 1952, the subject parcel was a component of a larger agricultural property that contributed to a patchwork of orchards and other rural land uses approximately 1.5 miles northwest of central Mountain View. Aerial photographs indicate that surrounding communities expanded by way of rapid residential and commercial development on agricultural lands during the 1950s and 1960s. By the mid-1950s, this general pattern of development led to the construction of a collection of commercial buildings along San Antonio Road, a once rural road (NETR 1948, 1956).

Santa Clara County Assessor's Office records indicate the building at 365 San Antonio Road was constructed in 1952, which is supported by available historic aerial photographs. Mountain View city directories, available online through Ancestry.com, as well as regional newspapers identify several past occupants of the subject building. The earliest known tenants were Palo Alto Appliance, Proto Type Machine Shop, and Robb-Jack Corp. (a tool manufacturer), as listed in the 1962 Mountain View city directory (R.L. Polk & Co. 1963:108). As such, it appears the property housed multiple commercial and light industrial uses simultaneously. Although newspapers confirm that Palo Alto Appliance was at the address in 1963 (*San Francisco Examiner* 1963:32), by the publication of the 1964 city directory, the appliance store had been replaced by Jones Ron Associates, which sold boats (R.L. Polk & Co. 1964:176). Proto Type Machine Shop and Robb-Jack Corp. remained in the building through 1966; they were joined by the Franciscan Glass Company (R.L. Polk & Co. 1966:202). However, none of these businesses remained in the building in 1968. That year, city directories indicate that the sole tenant was San José Paint, which occupied the building until at least 1977, the last time the establishment received mention in local newspapers (R.L. Polk & Co. 1968:247; *San Francisco Examiner* 1977:50). The building's commercial tenant from 1984 to 1988 was Keyboard Distributors, a piano retailer (*Salinas Californian* 1984:16; *San Francisco Examiner* 1988:A-12). The current tenant of 365 San Antonio Road is PerceptiMed, a company founded in 2013 to develop technologies for prescription pill dispensing (PerceptiMed 2021).

National Register of Historic Places/California Register of Historical Resources Evaluation of 365 San Antonio Road

The building at 365 San Antonio Road is not currently listed in, and has not been found eligible for listing in, the National Register of Historic Places (NRHP) or California Register of Historical Resources (CRHR). The following provides an evaluation of the building at 365 San Antonio Road under NRHP/CRHR Criteria A/1–D/4:

Page 4 of 7

*Resource Name or #(Assigned by recorder) 365 San Antonio Road

*Recorded by Jon Rusch, ICF

*Date July 9, 2021

Continuation Update

CRITERIA A/1 (Events): Associated with events that have made a significant contribution to the broad patterns of local or regional history or the cultural heritage of California or the United States.

The building at 365 San Antonio Road is not associated with any event(s) of historical significance. The building appears to have been constructed as a commercial and industrial building, serving the surrounding communities of northwestern Santa Clara County. The types of tenants known to have occupied the building after its 1952 construction include an appliance store, paint store, musical instrument store, and various light industrial businesses. None of these tenants appears exceptional within the context of a quickly developing suburban area of the San Francisco Bay region during the post-World War II period. Rather, the building appears to represent an unremarkable pattern of commercial development that occurred throughout Mountain View and its surrounding communities during the mid-20th century. None of the identified tenants of the building is known to have contributed significantly to local, state, or national economies. Newspaper research did not find the building to have been associated with any other important single events, patterns of events, repeated activities, or historic trends; rather, it appears to have contributed to everyday community and commercial life. For these reasons, the building at 365 San Antonio Road is not significant under NRHP/CRHR Criteria A/1.

CRITERIA B/2 (Person): Associated with the lives of persons important to local, California, or national history.

Research did not reveal that the subject property has been associated with the lives of persons significant at the local, state, or national level. Although none of its past owners were identified, the commercial building has a broad and unremarkable association with local community life and economic patterns, as described above. It would be expected that any significant person associated with the subject property would have been widely publicized in local newspaper accounts, but newspaper research yielded no such evidence of associations with significant individuals. Furthermore, no evidence suggests that the building housed activities that allowed a particular owner, tenant, or employee to achieve historical significance that would be best conveyed by the building. For these reasons, the building at 365 San Antonio Road is not significant under NRHP/CRHR Criteria B/2.

CRITERIA C/3 (Design/Construction): Embodies the distinctive characteristics of a type, period, region or method of construction or represents the work of a master or possesses high artistic values.

The subject property does not embody distinctive characteristics of a type, period, or method of construction, nor does it represent the work of a master or possess high artistic value. The building is a relatively utilitarian one-story commercial building that lacks architectural distinction and appears to have been altered substantially since its construction in 1952. Only the building's roof form and one extant divided-lite window allow the trained eye to identify its general age and aspects of its original appearance. Even so, the use of these features was common during the immediate post-World War II period, and no evidence in the available historical record or visible to investigators suggests that this small-scale building originally had a noteworthy architectural design. Regardless, the changes to the exterior material palette and very likely to its window configuration further limit its ability to embody the distinctive characteristics of a type, period, region, or method of construction or express high artistic merit. Although research did not reveal the identities of the building's original architect and builder, it is unlikely that a master design professional was involved in what appears to be a small utilitarian commercial project on the outskirts of Mountain View in the 1950s. Even if a notable architect were responsible for the building's original design, the alterations previously described would eliminate any possibility that the building could represent that person's important body of work. For these reasons, the building at 365 San Antonio Road is not significant under NRHP/CRHR Criteria C/3.

CRITERIA D/4 (Information Potential): Has yielded, or has the potential to yield, information important to the prehistory or history of the local area, California, or the nation.

The subject property at 365 San Antonio Road does not appear to be a source, or likely source, of important historical information not already captured in the historic record. Therefore, it is not significant under NRHP/CRHR Criteria D/4.

Conclusion

Based on an evaluation of the building at 365 San Antonio Road under NRHP/CRHR Criteria A/1–D/4, the building is not eligible for individual listing in the NRHP or CRHR. The property is therefore not a historical resource for the purposes of the California Environmental Quality Act (CEQA), in accordance with Section 15064.5(a)(2)-(3) of the CEQA Guidelines, using the criteria outlined in Section 5024.1 of the California Public Resources Code.

Page 5 of 7

*Resource Name or #(Assigned by recorder) 365 San Antonio Road

*Recorded by Jon Rusch, ICF

*Date July 9, 2021

Continuation Update

***B12. References (continued):**

City of Mountain View. 2021. *Search Permit History, 365 San Antonio Road*. Available: <https://epermits.mountainview.gov/h.aspx>. Accessed: July 2, 2021.

LSA Associates, Inc. 2011. *City of Mountain View Draft 2030 General Plan and Greenhouse Gas Reduction Program Environmental Impact Report*. Public Review Draft. November. State Clearinghouse No. 2011012069. Prepared for City of Mountain View, CA.

Nationwide Environmental Title Research, LLC. 1948, 1956, 1960, 1968, 1987, 1991. *Historic Aerials, 365 San Antonio Road, Mountain View, California*. Available: www.historicaerials.com/viewer. Accessed: June 30, 2021.

ParcelQuest. 2021. *Detail Report, 365 San Antonio Road, Mountain View, California*. Available: <http://www.parcelquest.com/>. Accessed: July 1, 2021.

PerceptiMed. 2021. *About Us*. Available: <https://perceptimed.com/company/about-us/>. Accessed: July 2, 2021.

R.L. Polk & Co. 1963. *Polk's Mountain View Directory of Householders, Occupants of Office Buildings, and Other Business Places, Including a Complete Street and Avenue Guide, 1962*. Los Angeles, CA: R.L. Polk & Co.

———. 1964. *Polk's Mountain View Street and Avenue Guide, Including Telephone Numbers and Home Owner Symbols, 1964*. Los Angeles, CA: R.L. Polk & Co.

———. 1966. *Polk's Mountain View Street and Avenue Guide, Including Telephone Numbers and Home Owner Symbols, 1965–1966*. Los Angeles, CA: R.L. Polk & Co.

———. 1968. *Polk's Mountain View Street and Avenue Guide, Including Telephone Numbers, Home Owner Symbols, and Zip Codes, 1968*. Los Angeles, CA: R.L. Polk & Co.

Salinas Californian. 1984. Music Contest Announced. December 14.

The San Francisco Examiner. 1963. Dishes Get Cleaner [advertisement]. December 9.

———. 1977. 1¢ Wallpaper Sale! [advertisement]. April 14.

———. 1988. Grand Piano Fair [advertisement]. August 25.

Page 6 of 7

*Recorded by Jon Rusch, ICF

*Date July 9, 2021

*Resource Name or #(Assigned by recorder) 365 San Antonio Road

Continuation Update

Additional Photographs:



Figure 2. West (primary) façade, viewed facing southeast. Source: ICF.



Figure 3. South façade, viewed facing northeast. Source: ICF.

Page 7 of 7

*Recorded by Jon Rusch, ICF

*Date July 9, 2021

*Resource Name or #(Assigned by recorder) 365 San Antonio Road

Continuation Update



Figure 4. Rear (east) façade, viewed facing west. Source: ICF.



Figure 5. North façade, viewed facing southeast. Source: ICF.

P1. Other Identifier: Eaves Mountain View at Middlefield Apartments

*P2. Location: Not for Publication Unrestricted *a. County Santa Clara County

And (P2b and P2c or P2d. Attach a Location Map as necessary.)

*b. USGS 7.5' Quad Mountain View Date 2018 T; R; of Sec ____; B.M.

c. Address: 2585 California Street City Mountain View Zip 94040

d. UTM: (give more than one for large and/or linear resources) Zone 10 S; 578753.91 m E/4140203.31 m N

e. Other Locational Data: (e.g., parcel #, directions to resource, elevation, etc., as appropriate) APN: 148-22-007

*P3a. Description: (Describe resource and its major elements. Include design, materials, condition, alterations, size, setting, and boundaries)

The property at 2585 California Street contains a one-story commercial building with a modified rectangular plan and a composite but primarily flat roof. The building, which most recently housed a grocery store but is now vacant, fills the western portion of an approximately 100- by 100-foot parcel; the eastern portion of the parcel contains an asphalt-paved loading area. The building comprises multiple rectangular flat- and shed-roofed volumes. The primary volume forms the western half of the building, with attached volumes that project from the east façade and that contain the building's primary entrance. A partially enclosed addition, c. 2010, projects from the north façade toward California Street. It features a sloped awning roof and a series of windows and door openings with metal roll-up security shutters. The parcel also contains a pole that previously supported a sign with the name of the building's tenant, the Milk Pail Market.

(See continuation sheet.)

*P3b. Resource Attributes: (List attributes and codes) HP6 (1- to 3-story commercial building)

*P4. Resources Present: Building Structure Object Site District Element of District Other

P5a. Photograph or Drawing (Photograph required for buildings, structures and objects)



Figure 1: East façade of 2585 California Street, viewed facing west. Source: ICF.

P5b. Description of Photo: (View, date, accession #) View looking west, 7/9/2021

*P6. Date Constructed/Age and Sources:
 Historic Prehistoric Both
1961 (Assessor's Records)

*P7. Owner and Address:
MGP IX SAC MP&P, LLC
425 California Street, Floor 10
San Francisco, CA 94104

*P8. Recorded by: (Name, affiliation, address)
Jon Rusch, ICF
201 Mission Street, Suite 1500
San Francisco, CA 94105

*P9. Date Recorded: July 9, 2021

*P10. Survey Type: (Describe) Intensive

*P11. Report Citation: ICF. 2021. *The Village at San Antonio – Phase III*. Addendum. Date pending. (ICF 00693.20.) San Francisco, CA. Prepared for City of Mountain View, Mountain View, CA.

*Attachments: NONE Location Map Sketch Map Continuation Sheet Building, Structure, and Object Record Archaeological Record
 District Record Linear Feature Record Milling Station Record Rock Art Record Artifact Record Photograph Record
DPR 523A (9/2013) *Required Information

BUILDING, STRUCTURE, AND OBJECT RECORD

Page 2 of 7

*NRHP Status Code 6Z

*Resource Name or # (Assigned by recorder) 2585 California Street

B1. Historic Name: Moore's Dairy Products

B2. Common Name: Milk Pail Market

B3. Original Use: Drive-through dairy

B4. Present Use: Grocery store (vacant)

*B5. Architectural Style: No discernible style (altered)

*B6. Construction History: (Construction date, alteration, and date of alterations)

The building at 2585 California Street has a construction date of 1961 (ParcelQuest 2021). Available historic aerial photographs indicate the building's early footprint was generally "L" shaped, which may correspond to the current primary volume and the wing that projects from the northeast corner. Summaries of four building permits issued between 1999 and 2010 are available on the City of Mountain View website; these permits document the construction of a trash enclosure c. 1999 and installation of a canopy, curtains, and removable railing c. 2010. This scope of work may refer to the addition of the primary entrance vestibule, which Google Street View images document as having been built at approximately that time. The north addition was constructed between 2008 and 2011 (Google 2021; City of Mountain View 2021; Nationwide Environmental Title Research [NETR] 1968)

*B7. Moved? No Yes Unknown Date: N/A

Original Location: N/A

*B8. Related Features: N/A

B9a. Architect: Unknown

b. Builder: Unknown

*B10. Significance: Theme N/A

Area N/A

Period of Significance N/A

Property Type N/A

Applicable Criteria N/A

(Discuss importance in terms of historical or architectural context as defined by theme, period, and geographic scope. Also address integrity.)

Historic Context: Mountain View

Prior to the arrival of European explorers and settlers in the 1760s and 1770s, the Santa Clara Valley's primary inhabitants were the Ohlone people. Spanish missions became the first European settlements in the area during the final quarter of the 18th century. Over the next 100 years, waves of European-American settlers arrived in the region as a result of the 1848 California Gold Rush and subsequent railroad developments; they, in turn, established new farms, residences, and community nodes (LSA Associates, Inc. 2011:450–451).

(See continuation sheet.)

B11. Additional Resource Attributes: (List attributes and codes)

*B12. References: (See continuation sheet.)

B13. Remarks: N/A

*B14. Evaluator: Jon Rusch, ICF

*Date of Evaluation: 7/9/2021

(This space reserved for official comments.)



Page 3 of 7

*Resource Name or #(Assigned by recorder) 2585 California Street

*Recorded by Jon Rusch, ICF

*Date July 9, 2021

Continuation Update

***P3a. Description (continued):**

The adjacent parcel to the west contains a surface parking lot, and the adjacent parcel to the south is landscaped with trees, shrubs, and grasses. The subject building is approximately one-half block east of the intersection of California Street and San Antonio Road. The general character of this intersection is low-scale (one-story) commercial development, although numerous taller (up to five-story) residential and commercial complexes lie to the south and west. The parcel north of the subject building (across California Street) is currently an active construction site.

The east façade of the building features the main entrance, which is south of center (Figure 1). The entrance comprises an unenclosed vestibule that projects toward the east. The vestibule, which housed produce racks for the building's long-term occupant, the Milk Pail Market, is sheltered by a gabled steel-frame roof structure, which is supported by posts and covered in canvas. South of the main entrance is a trash enclosure and mechanical yard, which are surrounded by metal chain-link fencing. North of the main entrance, the façade is clad in stucco; it features one sliding door for loading and unloading food shipments. This portion of the façade also features a canvas awning below the roofline as well as an overhanging eave with exposed support beams. The east façade also includes one side of the partially enclosed north addition. On this façade, the addition has one window opening and one door opening, which is reached from an access ramp with metal handrails. The openings have metal security shutters.

The north façade (Figure 2), facing California Street, contains the widest face on the north addition. The lower half of the addition's walls are clad in stucco, above which are three window openings with metal security shutters. The openings are separated by scored stucco piers, which support horizontal wood beams and the metal framing for the awning roof. A planting bed lines the base of the wall at this façade. At the west end of the north façade is a section of the primary (east) building volume, which is constructed of concrete. This portion of the façade features mechanical equipment and a single pedestrian door atop a concrete ramp and single riser. The west façade (Figure 3) is clad in cinder blocks; it has no decorative features. Vegetation in the adjoining parcel obscures the south façade, as viewed from the public right-of-way.

***B10. Significance (continued):**

Mountain View was a 19th-century stagecoach stop along El Camino Real, the route that connected California's missions. The community grew as the Santa Clara Valley gained prominence as an agricultural production center during the late 19th century. The town incorporated in 1902 with fewer than 1,000 residents. The agricultural and horticultural economy that had sustained Mountain View remained strong until World War II, at which point the ascendance of new technology, as well as the electronics industries in the region, shifted the focus.

Following World War II, an influx of new residents spurred a pattern of suburban tract residential development across the valley's formerly agricultural lands. Moffett Federal Airfield, the Lockheed Missile and Space Company, and the NASA Ames Research Center all contributed to the early growth in the high-tech industries that took hold around Mountain View and ultimately led to the region's christening as "Silicon Valley." Like many small communities on the San Francisco Peninsula and in the Santa Clara Valley in the mid-20th century, Mountain View experienced enormous population growth, with just under 4,000 residents in 1940 but more than 30,000 by 1960. These trends continued and even accelerated in subsequent decades, fueled by the ascendance of industries associated with the personal computer and further land development associated with the region's commercial and technology sectors (LSA Associates, Inc. 2011:451-453).

Site History

Prior to construction of the building at 2585 California Street in 1961, the subject parcel was a component of a larger agricultural property that contributed to a patchwork of orchards and other rural land uses approximately 1.5 miles northwest of central Mountain View. Aerial photographs indicate that surrounding communities expanded by way of rapid residential and commercial development on agricultural lands during the 1950s and 1960s. By the mid-1950s, this general pattern of development led to the construction of a collection of commercial buildings along nearby San Antonio Road, a once rural road (NETR 1948, 1956).

The Santa Clara County Assessor's Office dates the building's construction to 1961, at which time it contributed to a small commercial area near the intersection of California Street and San Antonio Road. The earliest available Mountain View city directory identifies the earliest (and most likely original) tenant of the building as Moore's Dairy Products, which apparently used the building as a drive-through dairy stand (R.L. Polk & Co. 1963:25). Newspaper research uncovered no details on this business; it appears that Moore's Dairy Products occupied the building for only a short time. By the publication of the 1964 city directory, Moore's Dairy Products had been replaced by another dairy retailer, Brentwood Farms, which remained at 2565 California Street until at least 1968 (R.L. Polk & Co. 1964:39; R.L. Polk & Co. 1966:45; R.L. Polk & Co. 1968:47).

In 1974, the dairy that occupied the building went bankrupt. Members of Castro Valley's Rasmussen family took over the lease. The Rasmussens founded the Milk Pail, a drive-through dairy that very likely continued the same business model employed by the building's previous occupants. For its first 5 years, the Milk Pail received shipments of raw milk from a regional creamery, then pasteurized and

Page 4 of 7

*Resource Name or #(Assigned by recorder) 2585 California Street

*Recorded by Jon Rusch, ICF

*Date July 9, 2021

Continuation Update

homogenized it on the site before selling it to customers. A photograph of the original building, taken in the 1970s (Figure 4), shows that it was smaller; it featured a broad sliding door where customers were served. Dairy products were the business's initial focus; the Milk Pail began to offer cheese in 1975. However, the owners slowly diversified their food offerings. In 1979, the business moved the milk processing equipment off-site, which allowed the subject building to evolve into the Milk Pail Market. Walk-in service began in 1984, and the business owners introduced produce a few years later. The business was branded as an "open-air European market" and gained local popularity as a specialty market, selling regionally sourced cheeses, meats, fruits and vegetables, and other products. The Milk Pail Market closed in 2019 after 45 years in operation, although it did run contactless grocery pickup from its Wyandotte Street warehouse in 2020 during the COVID-19 pandemic (Martichoux 2019; Milk Pail Market 2016:1–2; Milk Pail Market 2020).

National Register of Historic Places/California Register of Historical Resources Evaluation of 2585 California Street

The building at 2585 California Street is not currently listed in, and has not been found eligible for listing in, the National Register of Historic Places (NRHP) or California Register of Historical Resources (CRHR). The following provides an evaluation of the building at 2585 California Street under NRHP/CRHR Criteria A/1–D/4:

CRITERIA A/1 (Events): Associated with events that have made a significant contribution to the broad patterns of local or regional history or the cultural heritage of California or the United States.

The building at 2585 California Street is not associated with any event(s) of historical significance. The building appears to have been constructed as a drive-through dairy, a role it continued to serve through the 1970s, before the Milk Pail Market expanded its offerings and became a specialty grocery store. Although the Milk Pail Market was highly valued by many local customers and able to distinguish itself from its competitors by becoming a "European-style" market, its popularity does not imbue significance to the extent that the building would qualify for historic register listing. Consumer-grade dairy distribution and specialty-food retail operations in the second half of the 20th century are not historic contexts that are unique or remarkable to Mountain View or the surrounding Santa Clara Valley. Rather, the original tenants and the Milk Pail Market appear generally representative of the many types of commercial establishments that served the consumer needs of a rapidly growing Mountain View after World War II. None of the known tenants of the building are known to have contributed significantly to local, state, or national economies. Newspaper research did not find the building to have been associated with any other important single events, patterns of events, repeated activities, or historic trends; rather, it appears to have contributed to everyday community and commercial life. For these reasons, the building at 2585 California Street is not significant under NRHP/CRHR Criteria A/1.

CRITERIA B/2 (Person): Associated with the lives of persons important to local, California, or national history.

Research did not reveal that the subject property has been associated with the lives of persons significant at the local, state, or national level. No evidence suggests that the building housed activities that allowed a particular owner, tenant, or employee to achieve historical significance that would be best conveyed by the building. Although the original owners were not identified, the commercial building had a broad and unremarkable association with local community life and economic patterns during the 1960s, as described above. Research indicates that members of the Rasmussen family, who operated the Milk Pail Market in the building between 1974 and 2019, were valued community members, but it does not appear that they had a direct and measurable influence on local, state, or national history to the extent that would qualify the building for historic register eligibility. For these reasons, the building at 2585 California Street is not significant under NRHP/CRHR Criteria B/2.

CRITERIA C/3 (Design/Construction): Embodies the distinctive characteristics of a type, period, region or method of construction or represents the work of a master or possesses high artistic values.

The subject property does not embody distinctive characteristics of a type, period, or method of construction, nor does it represent the work of a master or possess high artistic value. Based on the available photograph of the building from the 1970s (Figure 4), it appears relatively utilitarian in style, lacking features that would associate it with potentially significant architectural trends. Furthermore, the building has been altered repeatedly over time through the construction of new additions, changes to cladding and windows, and the addition of awnings. No elements of the building are easily identifiable as original to its construction date of 1961, and its overall aesthetic is commonplace for a commercial property that operated and expanded during the late 20th and early 21st centuries. Because of its unremarkable original design and the alterations it has undergone, the building does not embody the distinctive characteristics of a type, period, region, or method of construction, and it does not express high artistic merit. Although research did not reveal the identities of the building's original architect and builder, it is unlikely that a master design professional was involved in this small and utilitarian commercial project on the outskirts of Mountain View in the early 1960s. Even if a notable architect were responsible for the building's original design, the alterations previously described would eliminate any possibility that the building could represent that person's important body of work. For these reasons, the building at 2585 California Street is not significant under NRHP/CRHR Criteria C/3.

CRITERIA D/4 (Information Potential): Has yielded, or has the potential to yield, information important to the prehistory or history of the local area, California, or the nation.

Page 5 of 7

*Resource Name or #(Assigned by recorder) 2585 California Street

*Recorded by Jon Rusch, ICF

*Date July 9, 2021

Continuation Update

The subject property at 2585 California Street does not appear to be a source, or likely source, of important historical information not already captured in the historic record. Therefore, it is not significant under NRHP/CRHR Criteria D/4.

Conclusion

Based on an evaluation of the building at 2585 California Street under NRHP/CRHR Criteria A/1–D/4, the building is not eligible for individual listing in the NRHP or CRHR. The property is therefore not a historical resource for the purposes of the California Environmental Quality Act (CEQA), in accordance with Section 15064.5(a)(2)-(3) of the CEQA Guidelines, using the criteria outlined in Section 5024.1 of the California Public Resources Code.

***B12. References (continued):**

City of Mountain View. 2021. *Search Permit History, 2585 California Street*. Available: <https://epermits.mountainview.gov/h.aspx>. Accessed: July 2, 2021.

Google. 2021. Street View images, 2585 California Street, Mountain View, California. Available: <https://www.google.com/maps>. Accessed: July 2, 2021.

LSA Associates, Inc. 2011. *City of Mountain View Draft 2030 General Plan and Greenhouse Gas Reduction Program Environmental Impact Report*. Public Review Draft. November. State Clearinghouse No. 2011012069. Prepared for City of Mountain View, CA.

Martichoux, Alix. 2019. Beloved Mountain View Grocery Store Closing after 45 Years in Business. *San Francisco Chronicle*. March 20. Available: <https://www.sfgate.com/food/article/milk-pail-market-closing-date-reason-mountain-view-13703595.php>. Accessed: July 1, 2021.

Milk Pail Market. 2016. *Forty-Two Years and Counting!* Available: <https://www.milkpail.com/wp-content/uploads/2016/10/View-the-Story-for-about-us-testimonials-page.pdf>. Accessed: July 1, 2021.

———. 2020. *About Us*. Available: <https://milkpail.com/about-ustestimonials/>. Accessed: July 1, 2021.

Nationwide Environmental Title Research, LLC. 1948, 1956, 1968. *Historic Aerials, 2585 California Street, Mountain View, California*. Available: www.historicaerials.com/viewer. Accessed: July 1, 2021.

ParcelQuest. 2021. *Detail Report, 2585 California Street, Mountain View, California*. Available: <http://www.parcelquest.com/>. Accessed: July 1, 2021.

R.L. Polk & Co. 1963. *Polk's Mountain View Directory of Householders, Occupants of Office Buildings, and Other Business Places, Including a Complete Street and Avenue Guide, 1962*. Los Angeles, CA: R.L. Polk & Co.

———. 1964. *Polk's Mountain View Street and Avenue Guide, Including Telephone Numbers and Home Owner Symbols, 1964*. Los Angeles, CA: R.L. Polk & Co.

———. 1966. *Polk's Mountain View Street and Avenue Guide, Including Telephone Numbers and Home Owner Symbols, 1965-1966*. Los Angeles, CA: R.L. Polk & Co.

———. 1968. *Polk's Mountain View Street and Avenue Guide, Including Telephone Numbers, Home Owner Symbols, and Zip Codes, 1968*. Los Angeles, CA: R.L. Polk & Co.

Page 6 of 7

*Recorded by Jon Rusch, ICF

*Date July 9, 2021

*Resource Name or #(Assigned by recorder) 2585 California Street

Continuation Update

Additional Photographs:



Figure 2. North façade, viewed facing south. Source: ICF.



Figure 3. West façade, viewed facing east. Source: ICF.

Page 7 of 7

*Recorded by Jon Rusch, ICF

*Date July 9, 2021

*Resource Name or #(Assigned by recorder) 2585 California Street

Continuation Update



Figure 4. Milk Pail, c. 1970s, most likely viewed facing east.
Source: Milk Pail Market 2020.

Appendix C
Noise Supporting Materials

Construction Noise Modeling

Construction Equipment List

Screening Analysis

Phase	Equipment Type	Fuel Type	Quantities per day	Horsepower	Hours/day	Construction Equipment Terminology	Lmax Noise Level 50 feet	FHWA Utilization Rate	Rank	3 Loudest Equipment By Phase
Demo/Clear	CAT 330 Excavator	Diesel	2	273	8	Excavator	81	40%	2	Excavator
	Water Truck	Diesel	1	350	4	Dump Truck	76	40%	3	Dump Truck
	Street Sweeper	Diesel	1	210	4	Vacuum Street Sweeper	82	10%	1	Vacuum Street Sweeper
Excavation/Shoring/Grading	CAT 330 Excavator	Diesel	1	273	8	Excavator	81	40%	5	
	CAT 963 Loader	Diesel	1	202	8	Front end loader	79	40%	8	
	CAT 48" Compactor	Diesel	1	248	8	Roller	80	20%	7	
	Water Truck	Diesel	1	350	4	Dump Truck	76	40%	9	
	Street Sweeper	Diesel	1	210	4	Vacuum Street Sweeper	82	10%	4	
	Lo-Ho Drill DH40	Diesel	1	236	8	Auger Drill Rig	84	20%	1	Auger Drill Rig
	Mantis 30T Crawler	Diesel	1	173	8	Crane	81	16%	5	
	Cammachio MC20	Diesel	1	275	8	Auger Drill Rig	84	20%	1	Auger Drill Rig
	Delmag RH26	Diesel	1	375	8	Auger Drill Rig	84	20%	1	Auger Drill Rig
Foundation	Mobile Crane	Diesel	1	175	8	Crane	81	16%	3	
	Gradall	Diesel	1	80	8	Gradall	83	40%	2	Gradall
	Forklift	Diesel	1	62	8	Tractor	84	40%	1	Tractor
	Scissor Lift	Electric	3		8	Man Lift	75	20%	5	
	Concrete Pumps	Diesel	1		8	Concrete Pump Truck	81	20%	3	Concrete Pump Truck
Building Structure/Exterior System	Gradall	Diesel	2	80	8	Gradall	83	40%	2	Gradall
	Forklifts	Diesel	1	62	8	Tractor	84	40%	1	Tractor
	Boom Lifts	Diesel	2	80	8	Man Lift	75	20%	4	
	Concrete Pumps	Diesel	1		8	Concrete Pump Truck	81	20%	3	
	Welder	Diesel	2		8	Welder / Torch	74	40%	5	
Site Improvements	Backhoe	Diesel	1	78	8	Backhoe	78	40%	2	Backhoe
	Soil Compactors	Diesel	1	248	8	Compactor (ground)	83	20%	1	Compactor (ground)
Final Closeout	Gradall	Diesel	2	80	8	Gradall	83	40%	1	Gradall
	Boom Lifts	Diesel	1	80	8	Man Lift	75	20%	2	Man Lift
Nighttime Concrete Pours	Concrete Pumps	Diesel	2		8	Concrete Pump Truck	81	20%	1	Concrete Pump Truck
	Concrete Mixer	Diesel	1		8	Concrete Mixer Truck	79	40%	2	Concrete Mixer Truck

Table 1. Construction Noise

Source Data:	Maximum Sound Level (dBA)	Utilization Factor	Leq Sound Level (dBA)
Construction Condition: Demolition			
Source 1: CAT 330 Excavator - Sound level (dBA) at 50 feet =	81	40%	77.0
Source 2: CAT 330 Excavator - Sound level (dBA) at 50 feet =	81	40%	77.0
Source 3: Street Sweeper - Sound level (dBA) at 50 feet =	82	10%	72.0
Calculated Data:			
All Sources Combined - Lmax sound level (dBA) at 50 feet =			86
All Sources Combined - Leq sound level (dBA) at 50 feet =			81

Distance Between Source and Receiver (ft.)	Geometric Attenuation (dB)	Ground Effect Attenuation (dB)	Calculated Lmax Sound Level (dBA)	Calculated Leq Sound Level (dBA)
50	0	0.0	86	81
100	-6	0.0	80	75
200	-12	0.0	74	69
300	-16	0.0	71	65
400	-18	0.0	68	63
500	-20	0.0	66	61
600	-22	0.0	65	59
700	-23	0.0	63	58
800	-24	0.0	62	57
900	-25	0.0	61	56
1000	-26	0.0	60	55

Geometric attenuation based on 6 dB per doubling of distance.

Note: This calculation does not include the effects, if any, of local shielding from walls, topography or other barriers which may reduce sound levels further.

Table 2. Construction Noise

Source Data:	Maximum Sound Level (dBA)	Utilization Factor	Leq Sound Level (dBA)
Construction Condition: Excavation, Shoring, and Grading			
Source 1: Cammachio MC20 - Sound level (dBA) at 50 feet =	84	20%	77.0
Source 2: Lo-Ho Drill DH40 - Sound level (dBA) at 50 feet =	84	20%	77.0
Source 3: Delmag RH26 - Sound level (dBA) at 50 feet =	84	20%	77.0
Calculated Data:			
All Sources Combined - Lmax sound level (dBA) at 50 feet =			89
All Sources Combined - Leq sound level (dBA) at 50 feet =			82

Distance Between Source and Receiver (ft.)	Geometric Attenuation (dB)	Ground Effect Attenuation (dB)	Calculated Lmax Sound Level (dBA)	Calculated Leq Sound Level (dBA)
50	0	0.0	89	82
100	-6	0.0	83	76
200	-12	0.0	77	70
300	-16	0.0	73	66
400	-18	0.0	71	64
500	-20	0.0	69	62
600	-22	0.0	67	60
700	-23	0.0	66	59
800	-24	0.0	65	58
900	-25	0.0	64	57
1000	-26	0.0	63	56

Geometric attenuation based on 6 dB per doubling of distance.

Note: This calculation does not include the effects, if any, of local shielding from walls, topography or other barriers which may reduce sound levels further.

a.) An auger drill rig was used to model Cammachio MC20, Lo-Ho Drill DH40, and Delmag RH26

Table 3. Construction Noise

Source Data:	Maximum Sound Level (dBA)	Utilization Factor	Leq Sound Level (dBA)
Construction Condition: Foundation			
Source 1: Concrete Pumps - Sound level (dBA) at 50 feet =	81	20%	74.0
Source 2: Gradall - Sound level (dBA) at 50 feet =	83	40%	79.0
Source 3: Forklift - Sound level (dBA) at 50 feet =	84	40%	80.0
Calculated Data:			
All Sources Combined - Lmax sound level (dBA) at 50 feet =			88
All Sources Combined - Leq sound level (dBA) at 50 feet =			83

Distance Between Source and Receiver (ft.)	Geometric Attenuation (dB)	Ground Effect Attenuation (dB)	Calculated Lmax Sound Level (dBA)	Calculated Leq Sound Level (dBA)
50	0	0.0	88	83
100	-6	0.0	82	77
200	-12	0.0	76	71
300	-16	0.0	72	68
400	-18	0.0	70	65
500	-20	0.0	68	63
600	-22	0.0	66	62
700	-23	0.0	65	60
800	-24	0.0	64	59
900	-25	0.0	63	58
1000	-26	0.0	62	57

Geometric attenuation based on 6 dB per doubling of distance.

Note: This calculation does not include the effects, if any, of local shielding from walls, topography or other barriers which may reduce sound levels further.

a.) A tractor was used to model forklift.

Table 4. Construction Noise

Source Data:	Maximum Sound Level (dBA)	Utilization Factor	Leq Sound Level (dBA)
Construction Condition: Building Structure, Exterior Systems			
Source 1: Gradall - Sound level (dBA) at 50 feet =	83	40%	79.0
Source 2: Forklifts - Sound level (dBA) at 50 feet =	84	40%	80.0
Source 3: Gradall - Sound level (dBA) at 50 feet =	83	40%	79.0
Calculated Data:			
All Sources Combined - Lmax sound level (dBA) at 50 feet =			88
All Sources Combined - Leq sound level (dBA) at 50 feet =			84

Distance Between Source and Receiver (ft.)	Geometric Attenuation (dB)	Ground Effect Attenuation (dB)	Calculated Lmax Sound Level (dBA)	Calculated Leq Sound Level (dBA)
50	0	0.0	88	84
100	-6	0.0	82	78
200	-12	0.0	76	72
300	-16	0.0	73	69
400	-18	0.0	70	66
500	-20	0.0	68	64
600	-22	0.0	67	63
700	-23	0.0	65	61
800	-24	0.0	64	60
900	-25	0.0	63	59
1000	-26	0.0	62	58

Geometric attenuation based on 6 dB per doubling of distance.

Note: This calculation does not include the effects, if any, of local shielding from walls, topography or other barriers which may reduce sound levels further.

a.) A tractor was used to model forklifts

Table 5. Construction Noise

Source Data:	Maximum Sound Level (dBA)	Utilization Factor	Leq Sound Level (dBA)
Construction Condition: Site Improvements			
Source 1: Backhoe - Sound level (dBA) at 50 feet =	78	40%	74.0
Source 2: Soil Compactors - Sound level (dBA) at 50 feet =	83	20%	76.0
Calculated Data:			
All Sources Combined - Lmax sound level (dBA) at 50 feet =			84
All Sources Combined - Leq sound level (dBA) at 50 feet =			78

Distance Between Source and Receiver (ft.)	Geometric Attenuation (dB)	Ground Effect Attenuation (dB)	Calculated Lmax Sound Level (dBA)	Calculated Leq Sound Level (dBA)
50	0	0.0	84	78
100	-6	0.0	78	72
200	-12	0.0	72	66
300	-16	0.0	69	63
400	-18	0.0	66	60
500	-20	0.0	64	58
600	-22	0.0	63	57
700	-23	0.0	61	55
800	-24	0.0	60	54
900	-25	0.0	59	53
1000	-26	0.0	58	52

Geometric attenuation based on 6 dB per doubling of distance.

Note: This calculation does not include the effects, if any, of local shielding from walls, topography or other barriers which may reduce sound levels further.

Table 6. Construction Noise

Source Data:	Maximum Sound Level (dBA)	Utilization Factor	Leq Sound Level (dBA)
Construction Condition: Final Close Out			
Source 1: Gradall - Sound level (dBA) at 50 feet =	83	40%	79.0
Source 2: Boom Lifts - Sound level (dBA) at 50 feet =	75	20%	68.0
Source 3: Gradall - Sound level (dBA) at 50 feet =	83	40%	79.0
Calculated Data:			
All Sources Combined - Lmax sound level (dBA) at 50 feet =			86
All Sources Combined - Leq sound level (dBA) at 50 feet =			82

Distance Between Source and Receiver (ft.)	Geometric Attenuation (dB)	Ground Effect Attenuation (dB)	Calculated Lmax Sound Level (dBA)	Calculated Leq Sound Level (dBA)
50	0	0.0	86	82
100	-6	0.0	80	76
200	-12	0.0	74	70
300	-16	0.0	71	67
400	-18	0.0	68	64
500	-20	0.0	66	62
600	-22	0.0	65	61
700	-23	0.0	63	59
800	-24	0.0	62	58
900	-25	0.0	61	57
1000	-26	0.0	60	56

Geometric attenuation based on 6 dB per doubling of distance.

Note: This calculation does not include the effects, if any, of local shielding from walls, topography or other barriers which may reduce sound levels further.

Table 7. Construction Noise

Source Data:	Maximum Sound Level (dBA)	Utilization Factor	Leq Sound Level (dBA)
Construction Condition: Nighttime Concrete Pouring			
Source 1: Concrete Pumps - Sound level (dBA) at 50 feet =	81	50%	78.0
Source 2: Concrete Pumps - Sound level (dBA) at 50 feet =	81	50%	78.0
Source 3: Concrete Mixer - Sound level (dBA) at 50 feet =	79	50%	76.0
Calculated Data:			
All Sources Combined - Lmax sound level (dBA) at 50 feet =			85
All Sources Combined - Leq sound level (dBA) at 50 feet =			82

Distance Between Source and Receiver (ft.)	Geometric Attenuation (dB)	Ground Effect Attenuation (dB)	Calculated Lmax Sound Level (dBA)	Calculated Leq Sound Level (dBA)
50	0	0.0	85	82
100	-6	0.0	79	76
200	-12	0.0	73	70
300	-16	0.0	70	67
400	-18	0.0	67	64
500	-20	0.0	65	62
600	-22	0.0	64	61
700	-23	0.0	62	59
800	-24	0.0	61	58
900	-25	0.0	60	57
1000	-26	0.0	59	56

Geometric attenuation based on 6 dB per doubling of distance.

Note: This calculation does not include the effects, if any, of local shielding from walls, topography or other barriers which may reduce sound levels further.

Traffic Noise Modeling

Existing Traffic Input Data

Segment Location	Posted Speed	ADT	Heavy Trucks	Medium Trucks	Vehicle Mix type
West of San Antonio Road	35	6710	1%	2%	1
Between San Antonio Road and North Driveway	35	12840	1%	2%	1
Between North Driveway and Pacchetti Way	35	12840	1%	2%	1
East of Pacchetto Way	35	8605	1%	2%	1
North of California St	35	36240	1%	2%	1
Between California Street and West Driveway	35	24570	1%	2%	1
between West Driveway and Miller Avenue	35	24570	1%	2%	1
Between Miller Avenue and Fayette Drive	35	22450	1%	2%	1
south of Fayette Drive	35	21330	1%	2%	1

Existing and Project Traffic Input Data

Segment Location	Posted Speed	ADT	Heavy Trucks	Medium Trucks	Vehicle Mix type
West of San Antonio Road	35	6905	1%	2%	1
Between San Antonio Road and North Driveway	35	13360	1%	2%	1
Between North Driveway and Pacchetti Way	35	13040	1%	2%	1
East of Pacchetto Way	35	8805	1%	2%	1
North of California St	35	37200	1%	2%	1
Between California Street and West Driveway	35	25440	1%	2%	1
between West Driveway and Miller Avenue	35	25085	1%	2%	1
Between Miller Avenue and Fayette Drive	35	22945	1%	2%	1
South of Fayette Drive	35	21805	1%	2%	1

Traffic Noise Modeling Results

Roadway	Segment Location	Distance Modeled (feet)	2019 ADT	Existing		
				dBA Ldn	dBA CNEL	dBA Leq
California Street	West of San Antonio Road	50	6,710	62.3	62.9	61.5
California Street	Between San Antonio Road and North Driveway	50	12,840	65.1	65.7	64.3
California Street	Between North Driveway and Pacchetti Way	50	12,840	65.1	65.7	64.3
California Street	East of Pacchetto Way	50	8,605	63.4	64.0	62.6
San Antonio Road	North of California St	50	36,240	69.6	70.2	68.8
San Antonio Road	Between California Street and West Driveway	70	24,570	66.3	66.9	65.5
San Antonio Road	between West Driveway and Miller Avenue	70	24,570	66.3	66.9	65.5
San Antonio Road	Between Miller Avenue and Fayette Drive	80	22,450	65.4	66.0	64.6
San Antonio Road	south of Fayette Drive	70	21,330	65.7	66.3	64.8

Roadway	Segment Location	Distance Modeled (feet)	2019 ADT	Existing + Project		
				dBA Ldn	dBA CNEL	dBA Leq
California Street	West of San Antonio Road	50	6,905	62.4	63.0	61.6
California Street	Between San Antonio Road and North Driveway	50	13,360	65.3	65.9	64.5
California Street	Between North Driveway and Pacchetti Way	50	13,040	65.2	65.8	64.4
California Street	East of Pacchetto Way	50	8,805	63.5	64.1	62.7
San Antonio Road	North of California St	50	37,200	69.7	70.3	68.9
San Antonio Road	Between California Street and West Driveway	70	25,440	66.4	67.0	65.6
San Antonio Road	between West Driveway and Miller Avenue	70	25,085	66.4	67.0	65.6
San Antonio Road	Between Miller Avenue and Fayette Drive	80	22,945	65.5	66.1	64.7
San Antonio Road	south of Fayette Drive	70	21,805	65.8	66.3	64.9

Note: Minor adjustments were made to the traffic volumes at the project driveways under the Existing No Project condition after the traffic noise modeling for the project was completed. The minor adjustments to the Existing no project condition would result a similar or smaller margin of traffic noise increases from Existing to Existing plus project conditions compared to the results reported in this appendix and in the Addendum. Therefore, the results of the traffic noise modeling are reasonably conservative and are still applicable to the project, even with the minor adjustments to the traffic volumes.

% Change in ADT	dB Change	dB Change	dB Change
3%	0.1	0.1	0.1
4%	0.2	0.2	0.2
2%	0.1	0.1	0.1
2%	0.1	0.1	0.1
3%	0.1	0.1	0.1
3%	0.2	0.2	0.2
2%	0.1	0.1	0.1
2%	0.1	0.1	0.1
2%	0.1	0.1	0.1

Appendix D
Multimodal Transportation Analysis



Multimodal Transportation Analysis (MTA)

San Antonio Center Phase III

Prepared by:

FEHR & PEERS

November 2021

Prepared for:

**ICF International
City of Mountain View**

San Antonio Center Phase III Multimodal Transportation Analysis (MTA)

Prepared for:
ICF International and City of Mountain View

November 2021

SJ21-2068

FEHR  PEERS

Table of Contents

Executive Summary	i
Project Traffic Estimates	i
Vehicle Adverse Effects.....	i
Vehicle Miles Traveled.....	ii
Site Access, Circulation, & San Antonio Precise Plan Consistency.....	ii
Introduction and Project Description	1
1. Introduction and Project Description	2
Purpose	2
Analysis Approach	2
Project Description	3
Study Area.....	6
San Antonio Precise Plan	6
Study Intersections.....	6
Analysis Scenarios.....	7
Report Organization	7
City Policy Conformance and Existing Conditions	10
2. City Policy Conformance	11
Metropolitan Transportation Commission’s (MTC) Regional Transportation Plan.....	11
Santa Clara Valley Transportation Authority VTP 2040.....	11
VTA Countywide Bike Plan	11
Congestion Management Program	12
City of Mountain View General Plan.....	12
AccessMV: Comprehensive Modal Plan.....	14
Mountain View Vision Zero Policy.....	14
San Antonio Precise Plan	14
3. Existing Conditions	16
Existing Street System	16
Existing Truck Routes.....	17
Existing Pedestrian Facilities	17
Existing Bicycle Network	19



Existing Transit Service.....	21
Existing Intersection Volumes Approach.....	26
Existing Intersection Operations.....	26
Existing Freeway Segment Operations.....	30
Field Observations.....	31
Site Access and Circulation	32
4. Site Access and On-Site Circulation	33
Pedestrian Access and Circulation.....	33
Bicycle Access and Circulation.....	33
Vehicle Access and Circulation.....	34
Emergency and Service Vehicle Access.....	34
Vehicle Miles Traveled Summary.....	37
5. Vehicle Miles Traveled Summary	38
Background Discussion.....	38
Overall Approach.....	38
Overview of Methods.....	39
Home-Based Work VMT Estimation Method.....	40
VMT Threshold.....	40
Project Generated VMT Impact Thresholds and Impact Criteria.....	40
VMT Estimates.....	41
VMT Reduction Discussion.....	42
Motor Vehicle Operations Analysis.....	43
6. Motor Vehicle Operations and Project Traffic Forecasting Methods.....	44
Traffic Analysis Methods.....	44
Analysis Methods and Thresholds.....	44
Signalized Intersections.....	44
Unsignalized Intersections.....	46
Freeway Segments.....	47
Project Traffic Volumes.....	47
Vehicle Trip Generation Phase III.....	47
Project Trip Targets – Phase II & Phase III.....	49
Vehicle Trip Distribution.....	52



Vehicle Trip Assignment.....	52
7. SAPP Consistency Evaluation.....	55
Consistency Evaluation	55
Trip Generation Comparison to San Antonio Precise Plan	55
Baseline Condition Comparison.....	56
Conclusion	57
8. Existing with Project Conditions	59
Existing with Project Intersection Analysis	59
Signal Warrant Analysis	61
Existing with Project Freeway Segment Analysis.....	63
9. Background and Background with Project Conditions	65
Background Conditions Roadway Infrastructure Improvements.....	65
Background Conditions Traffic Volumes	65
Intersection Analysis	67
Signal Warrant Analysis	67
10. Adverse Motor Vehicle Effects and Improvements	72
Adverse Effect Criteria	72
Signalized Intersections.....	72
Unsignalized Intersections	73
Adverse Effects and Improvements.....	74
Active Transportation and Transit Operations Analysis.....	75
11. Pedestrian Operations	76
Pedestrian Infrastructure.....	76
Pedestrian Access to Nearby Destinations	77
Pedestrian Quality of Service.....	77
ADA Compliance	77
12. Bicycle Operations	81
Bicycle Access to Nearby Destinations.....	81
Planned Bicycle Infrastructure.....	81
Bicycle User Experience (LTS)	82
13. Transit Operations	87



Transit Facilities and Improvements	87
Caltrain	87
VTA Bus	88
Access to Transit	88
Transit Operations	88
14. Parking Assessment	89

Appendices

Appendix A: Intersection Turning Movement Counts

Appendix B: Volume Adjustment Calculations

Appendix C: Study Intersection LOS Calculations

Appendix D: Freeway Screening Analysis

Appendix E: San Antonio Precise Plan Intersection Volume and Trip Generation Comparison

Appendix F: Background Project Trip Generation



List of Figures

Figure 1: Study Area	4
Figure 2: Site Plan	5
Figure 3: Existing Pedestrian Facilities	18
Figure 4: Existing Bicycle Facilities	22
Figure 5: Existing Bicycle and Pedestrian Volumes	23
Figure 6: Existing Transit Facilities	25
Figure 7: Existing Lane Configuration, Traffic Control, and Peak Hour Traffic Volumes	29
Figure 8: Project Site Parking Layout and Circulation	36
Figure 9: Location of TAZ 362 (TAZ boundary shown in purple and project site in blue.)	41
Figure 10: Vehicle Trip Distribution	53
Figure 11: Project Trip Assignment	54
Figure 12: Existing with Project Intersection Volumes	62
Figure 13: Background Intersection Volumes	70
Figure 14: Background with Project Intersection Volumes	71
Figure 15: Public Circulation Network from the San Antonio Precise Plan	78
Figure 16: Existing and Future Pedestrian Shed	79
Figure 17: Pedestrian Quality of Service from AccessMV	80
Figure 18: Existing and Future Bicycle Sheds	83
Figure 19: San Antonio Precise Plan Future Bicycle Facilities	84
Figure 20: AccessMV – Existing Conditions Bicycle Level of Stress Map	85
Figure 21: AccessMV – Future Conditions Bicycle Level of Stress Map	86

List of Tables

Table 1: Existing Transit Services	24
Table 2: Existing Intersection Levels of Service	27
Table 3: Existing Freeway Segment Levels of Service	30
Table 4: VMT Threshold Calculations	41
Table 5: Home-Based Work VMT Assessment	42
Table 6: Signalized Intersection Level of Service Definitions	45
Table 7: Signalized Intersection LOS Thresholds for Acceptable Operations	45



Table 8: Unsignalized Intersection Level of Service Definitions.....	46
Table 9: Phase III Trip Generation Using ITE Trip Generation and VTA Trip Reductions	48
Table 10: Phase II + Phase III Trip Targets – ITE 9 th Edition with a 30% TDM Reduction	49
Table 11: Phase II + Phase III Trip Targets – 10 th Edition with a 30% TDM Reduction	50
Table 12: Phase II + Phase III Trip Targets – 10 th Edition with 6.5% VTA TDM Reduction	51
Table 13: San Antonio Village Phase II + Phase III – Trip Target Comparison.....	51
Table 14: Trip Distribution	52
Table 15: San Antonio Precise Plan Trip Generation Comparison	56
Table 16: Existing and Existing with Project Intersection Levels of Service.....	60
Table 17: AM and PM Freeway LOS.....	64
Table 18: Background and Background with Project Intersection Levels of Service	68
Table 19: Vehicle Parking Requirements.....	89
Table 20: Bicycle Parking Requirements.....	90



Executive Summary

This report presents the results of a Multimodal Transportation Analysis (MTA) prepared for the San Antonio Village Phase III project at 365-405 San Antonio Road and 2585-2595 California Street in the *San Antonio Precise Plan* (SAPP) area in Mountain View, California. The project will demolish two existing commercial buildings consisting of 5,008 square feet of office uses and 4,386 square-feet of retail uses; and construct a new mixed-use building consisting of approximately 12,970 square feet of retail uses and 169,382 square feet of office uses. In total, the project will represent a net increase of approximately 8,584 square feet of retail uses and 164,374 square feet of office uses. The project also includes a new 283-stall parking structure.

The MTA is a supplemental transportation analysis that builds upon the *San Antonio Precise Plan Environmental Impact Report* (SAPP EIR, 2014). The purpose of the MTA is to 1) assess the project's consistency with transportation and parking policy and design elements of the SAPP and other City policies highlighted in the *Multi-Modal Transportation Handbook*, and 2) perform a multimodal site access analysis of the project's effect on the transportation network. The project is consistent with the *San Antonio Precise Plan*; therefore, the Cumulative Conditions analysis from the *SAPP EIR* can serve as the Cumulative Conditions analysis for the project. Project-specific adverse effects on the transportation network were evaluated following the guidelines of the City of Mountain View (i.e., the City's *MTA Handbook*) and the Santa Clara Valley Transportation Authority (VTA), the congestion management agency for Santa Clara County.

Project Traffic Estimates

The project will generate 1,766 net-new daily vehicle trips, 137 net-new morning peak hour vehicle trips (117 inbound and 20 outbound) and 184 net-new evening peak hour vehicle trips (40 inbound and 144 outbound). The net-new trip generation is the number of trips generated by the new development less the number of trips generated by the demolished uses.

The office component of the project will generate a total of 1,495 daily vehicle trips, 157 morning peak hour vehicle trips (136 inbound and 21 outbound) and 159 evening peak hour vehicle trips (25 inbound and 134 outbound). The combined office land use trip target of San Antonio Village Phases II and III (this project) is 515 AM net new vehicle trips (443 inbound and 72 outbound), and 536 PM net new vehicle trips (86 inbound and 450 outbound). This trip target is combined for phase II and III because of the shared parking.

Vehicle Adverse Effects

The intersection operational analysis determined that the project would not cause the study intersections to operate below their respective operational thresholds. Based on the location of the project and the trip generation, distribution and assignment, the project will not contribute more than one percent of the



freeway mixed-flow or High Occupancy Vehicle (HOV) lanes' capacity; therefore, a freeway analysis is not conducted consistent with VTA Guidelines.

Vehicle Miles Traveled

The project is consistent with the SAPP. The home-based work vehicle miles traveled (VMT) per employee rate is provided for informational purposes in this chapter because the SAPP EIR already disclosed the potential effects of the SAPP on the natural and human environment. After the certification of the SAPP EIR, the regulatory environment was changed by an update of the *California Environmental Quality Act Statutes and Guidelines* (December 2018) to require the use of VMT to identify potential transportation effects on the natural and human environment. As has been the practice for many years, the SAPP EIR already included VMT as an input into the air quality, greenhouse gas analysis and energy sections of the SAPP EIR to disclose the potential effects of the project on the environment. Therefore, the following baseline home-based work VMT per employee screening results from the Santa Clara Countywide VMT Estimation Tool (SCC VMT Tool) is presented for informational purposes only.

Using the SCC VMT Tool, the home-based work VMT per employee rate for the project is 15.51 miles. The project is not in a low VMT generating area because the project is in a transportation analysis zone (TAZ) with a home-based work VMT per employee rate of 15.51 which is greater than the VMT significance threshold. Specifically, the VMT per employee would be approximately 19 percent greater than the VMT threshold for home-based work VMT per employee of 13.03.

To have a less than significant VMT impact under CEQA, the project would need to generate less than 13.03 home-based work VMT per employee. Overall, CAPCOA indicates that projects in suburban areas may be able to achieve up to a 15 percent reduction in VMT.¹ Because the project will likely not be screened out, additional VMT analysis would be needed if the SAPP EIR were not already certified.

Site Access, Circulation, & San Antonio Precise Plan Consistency

This multimodal site access, circulation, and parking evaluation of the project focused on potential conflicts among vehicles, bicyclists, and pedestrians, and the project's consistency with the SAPP mobility policies, standards, and guidelines. The evaluation concludes that the project is supportive of the policies outlined in the SAPP.

¹ The current standard for calculating VMT reduction efficacy from TDM strategies is the California Air Pollution Control Officer Association (CAPCOA) 2010 report, *Quantifying Greenhouse Gas Mitigation Measures: A Resource for Local Government to Assess Emissions Reductions from Greenhouse Gas Mitigation Measures* (CAPCOA report). This resource evaluates the literature behind several TDM program elements and provides methods for calculating a VMT reduction associated with each.



Introduction and Project Description



1. Introduction and Project Description

This report presents the results of the Multimodal Transportation Analysis (MTA) for the San Antonio Village Phase III project located at 365 San Antonio Road and 2585 California Street in Mountain View, California. This chapter discusses the MTA purpose, project description, study area, analysis scenarios and methods, and report organization.

Purpose

The purpose of the MTA is to assess the project's consistency with transportation and parking policy and design elements of the *SAPP*. This MTA is a supplemental transportation analysis that builds upon the *SAPP EIR*. This analysis accomplishes the following:

- Determines the project's consistency with the transportation findings disclosed in the *San Antonio Precise Plan Environmental Impact Report (SAPP)* (2014) document;
- Assesses multimodal site access using the analysis from the *SAPP Transportation Impact Analysis*;
- Determines vehicle intersection operational issues attributed to this project;
- Determines the project's consistency with transportation and parking policy and design elements of the San Antonio Precise Plan (*SAPP*); and
- Presents a vehicle miles traveled (VMT) screening evaluation.

Analysis Approach

Because this project is within the San Antonio Precise Plan, this MTA is a supplemental transportation analysis that builds upon the *SAPP EIR* and the *SAPP Transportation Impact Analysis (TIA)*. The *SAPP TIA* included a transportation analysis that evaluated all modes of travel (including pedestrian, bicycle, transit, and vehicle modes) for the overall precise plan land use project (the *SAPP*). The *SAPP TIA* evaluation focused on the vehicle operations for freeways and intersections, and plan consistency with other modes of travel. Further, *The Village at San Antonio Center (Phase 2) – Final Transportation Impact Analysis* (March 2014) is referenced in this analysis to establish vehicle trip targets for the combined office from phases II and III of The Village at San Antonio Center project.



Therefore, this MTA supplements the *SAPP TIA* by providing:

- 1) a summary of the site's updated trip generation associated with Phase III and its distribution to the street system,
- 2) an off-site intersection analysis under Existing, Existing with Project Conditions, Background and Background with Project Conditions,
- 3) a review of the site plan regarding site access and on-site circulation, and
- 4) a project specific VMT screening.

Rather than create an entirely new analysis, this analysis relies on the extensive *SAPP EIR* analysis and *The Village at San Antonio Center (Phase 2) – Final Transportation Impact Analysis*.

Since the Phase III project's land use is consistent with the San Antonio Precise Plan (*SAPP*), the Cumulative Conditions analysis from the *San Antonio Precise Plan Transportation Impact Analysis (2014)* serves as the Cumulative Conditions analysis for the proposed project. This analysis also uses the same intersection deficiency criteria from *The Village at San Antonio Center (Phase 2) – Final Transportation Impact Analysis*, which is also consistent with the *City of Mountain View 2030 General Plan and Greenhouse Gas Reduction Program Environmental Impact Report* established the interim level of service policy standard.

This report is organized based on the guidance in the City of Mountain View's *Multi-Modal Transportation Analysis (MTA) Handbook* and the Santa Clara Valley Transportation Authority (VTA), the congestion management agency for Santa Clara County.

Project Description

This project will demolish two existing commercial buildings consisting of 5,008 square feet of office uses and 4,386 square-feet of retail uses; and constructing a new mixed-use building consisting of approximately 12,970 square feet of retail uses and 169,382 square feet of office uses. In total, the project will represent a net increase of approximately 8,584 square feet of retail uses and 169,374 square feet of office uses. The project also includes a new 283-stall parking structure. **Figure 1** shows the project location and study intersections.

The project is within the *SAPP* area and is in the southeast quadrant of the San Antonio Road and California Street intersection. The project is located approximately half of a mile (walking distance) from the closest Caltrain commuter rail station. The project site plan is presented on **Figure 2**.





- Project Site
- # Study Intersections
- City Boundaries



Figure 1
Study Area

VICINITY MAP

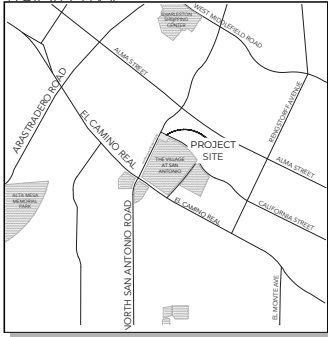

Source: Gensler

\\Fpsj03.fpaint.local\data\Projects_SJ21_Projects\SJ21_2068_SAPP_Amendment_MTA\Graphics\ADOBEGFig02_SitePlan.ai

Figure 2
Site Plan

Study Area

San Antonio Precise Plan

The proposed project is within the San Antonio Precise Plan Area, which is generally bounded by El Camino Real to the south, Central Expressway to the north, Del Monte Avenue to the west, and Ortega Avenue to the east. The *San Antonio Precise Plan*, adopted in December 2014, is publicly available on the City's website. The *SAPP* includes development standards, such as allowable land uses, parking requirements, and identifies new public improvements for the area. The *SAPP* complete street and land use policies were developed to support transit usage and active transportation.

Study Intersections

Project effects on the study area roadway facilities were determined by measuring the effect project traffic would have on intersection operations during the morning (7:00 to 9:00 AM) and evening (4:00 to 6:00 PM) peak periods. A total of 19 intersections were selected in consultation with City of Mountain View staff as study locations and are based on VTA's *Transportation Impact Analysis Guidelines* (updated October 2014). These locations are:

1. El Camino Real and Arastradero Road-Charleston Road (PA)*
2. El Camino Real and Del Medio Avenue (MV)
3. El Camino Real and San Antonio Road (MV)*, **
4. El Camino Real and Showers Drive (MV)**
5. El Camino Real and Ortega Avenue (MV)
6. El Camino Real and Rengstorff Avenue (MV)*
7. Fayette Drive and San Antonio Road (MV)**
8. Miller Avenue and San Antonio Road (MV)**
9. Nita Avenue and San Antonio Road (PA)
10. California Street and San Antonio Road (MV)**
11. California Street and Pacchetti Way (MV)**
12. California Street and Showers Drive (MV)**
13. California Street and Ortega Avenue (MV)
14. California Street and Rengstorff Avenue (MV)
15. Central Expressway and Rengstorff Avenue (SCC)*
16. Middlefield Road and San Antonio Road (PA)*
17. Charleston Road and San Antonio Road (PA)*
18. Project Driveway and San Antonio Road (MV)**
19. Project Driveway and California Street (MV)**

PA = Palo Alto; MV = Mountain View; SCC = Santa Clara County

* Congestion Management Program Intersection; ** = San Antonio Center Planning Area



Analysis Scenarios

The analysis was conducted during the morning peak hour occurring between 7:00 and 9:00 AM and the evening peak hour occurring between 4:00 and 6:00 PM for the following scenarios:

- Scenario 1:** *Existing Conditions* – Existing volumes obtained from traffic counts collected in October and November 2019 or April 2021², and existing geometry.
- Scenario 2:** *Existing with Project Conditions* – Volumes from Scenario 1 with net-added project traffic.
- Scenario 3:** *Background Conditions* – Volumes from Scenario 1 plus traffic from projects currently under construction and approved, but not yet constructed, developments in the area.
- Scenario 4:** *Background with Project Conditions* – Volumes from Scenario 3 with net-added project traffic.

Report Organization

This report is divided into six sections and thirteen additional chapters as described below:

- **City Policy Conformance and Existing Conditions**
 - **Chapter 2 – City Policy Conformance** lists the City of Mountain View General Plan polices, and City-specific land use and transportation plan goals, policies, standards, and federal, state, regional, and county jurisdictions plans that could be affected by this project. The city policy conformance assessment evaluates if the project would conflict with such plans and policies.
 - **Chapter 3 – Existing Conditions** describes the transportation system near the project site, including the surrounding roadway network, morning and evening peak hour turning movement volumes at the study intersections, existing bicycle, pedestrian, and transit facilities, intersection levels of service, freeway segment levels of service, and field observations.
- **Site Access and On-Site Circulation**
 - **Chapter 4 – Site Access and On-Site Circulation** describes project access and circulation for all travel modes. This evaluation focuses on accessibility for all users, multimodal access and circulation, existing street facilities, emergency vehicle access, and loading areas for various vehicle types.

² Counts were collected in October/November 2019 and April 2021 at El Camino Real and San Antonio Road and Fayette Drive and San Antonio Road. All other counts, collected only in April 2021, were adjusted based on a comparison between the 2019 and 2021 counts for the other two study intersections to simulate pre-COVID-19 conditions. **Appendix B** shows the volume calculations for these intersections.



- **Vehicle Miles Traveled Screening**
 - **Chapter 5 – Vehicle Miles Travel Screening** presents the VMT screening for the project using the VTA VMT Screening Tool.
- **Motor Vehicle Operations Analysis**
 - **Chapter 6 – Motor Vehicle Operations and Project Traffic Forecasting Methods** describes the traffic analysis methods, and traffic volumes used for the operation analysis chapters.
 - **Chapter 7 – SAPP Consistency Evaluation** presents a trip generation comparison and baseline conditions comparison to demonstrate how this project is consistent with that San Antonio Precise Plan.
 - **Chapter 8 – Existing with Project Conditions** presents the intersection operations for Existing with Project Conditions. The relevant project information and project trip generation, distribution, and assignment is also discussed in this chapter.
 - **Chapter 9 – Background Conditions** presents the intersection operations under Background Conditions and Background with Project Conditions.
 - **Chapter 10 – Motor Vehicle Adverse Effects and Improvements** describes the project's effects on intersection operations and identifies improvements to address adverse effects caused by the project.
- **Active Transportation and Transit Operations Analysis**
 - **Chapter 11 – Pedestrian Operations** provides supplemental pedestrian facilities analysis by highlighting the pedestrian transportation improvements described in the *San Antonio Precise Plan* area near the project site and summarizing the potential increase in pedestrian activity due to this project. This chapter also summarizes accessible paths from streets and parking lots to building entrances for this project and a walk shed analysis for this project site.
 - **Chapter 12 – Bicycle Operations** provides supplemental bicycle facilities analysis by highlighting the bicycle transportation improvements described in the *San Antonio Precise Plan* area near the project site and summarizing the potential increase in bicycle activity due to this project. This chapter also summarizes a bicycle shed analysis for this project site.
 - **Chapter 13 – Transit Operations** provides supplemental transit facilities analysis by highlighting the transit improvements described in the *San Antonio Precise Plan* area near the project site and summarizing the potential increase in transit activity due to this project. This chapter also summarizes transit access to/from the project site.



- **Parking**
 - **Chapter 14 – Parking** describes the existing parking facilities and conditions, and the projects parking management strategies and parking supply. The project parking supply is summarized and compare to the parking requirements.



City Policy Conformance and Existing Conditions



2. City Policy Conformance

This chapter provides a summary of the key transportation plans, goals and policies and related transportation networks that apply to this project.

The *Metropolitan Transportation Commission's (MTC) Regional Transportation Plan* provides a roadmap for accommodating projected household and employment growth in the nine-county Bay Area by 2040 as well as a transportation investment strategy for the region. The *Santa Clara Valley Transportation Authority VTP 2040 Plan* describes all major projects in Santa Clara Valley over the next 20 years. The *Congestion Management Program* sets State and federal funding priorities for transportation improvements affecting the Santa Clara County Congestion Management Program (CMP) transportation system. The *City of Mountain View General Plan 2030* includes mobility goals aimed to enhance travel by all modes by encouraging use by non-auto modes and thus reduce vehicle trips. The *San Antonio Precise Plan* implements the General Plan's goals and policies for the San Antonio Change Area and establishes the area's land use and development regulations.

Metropolitan Transportation Commission's (MTC) Regional Transportation Plan

Authored by the Metropolitan Transportation Commission, the Bay Area's regional transportation planning agency and federally designated Metropolitan Planning Organization (MPO), *Plan Bay Area 2040* (2017) is the Bay Area's Regional Transportation Plan (RTP) that provides a roadmap for accommodating projected household and employment growth in the nine-county Bay Area by 2040 as well as a transportation investment strategy for the region. *Plan Bay Area 2040* details how the Bay Area can make progress toward the region's long-range transportation and land use goals.

Santa Clara Valley Transportation Authority VTP 2040

Santa Clara Valley Transportation Authority (VTA), the regional transportation authority, has an adopted the Valley Transportation Plan (VTP) 2040 (adopted in October 2014) that describes all major projects and initiatives expected to occur in the next 20 years. It prioritizes complete streets, express lanes, light rail effectiveness upgrades, bus rapid transit, and bicycle/pedestrian improvements. Most recently, the Mountain View Light Rail Double Track project added a second light rail track between the Mountain View and Whisman stations to facilitate more frequent service. The VTA 2040 Plan also includes a package of projects in the San Antonio Precise Plan area including the reconfiguration of the US 101 Southbound Improvements from San Antonio Road to Charleston Road / Rengstorff Avenue.

VTA Countywide Bike Plan

The Santa Clara Countywide Bicycle Plan's primary goal was to make it easier and safer for people to bike when traveling from one city to the next in Santa Clara County. The plan establishes a network of Cross



County Bikeway Corridors that will provide continuous, complete bike connections across the county. The plan also identifies locations where new and improved bicycle connections are needed across freeways, rail lines, and creeks. Lastly, the plan identifies ways to make it easier for people to use their bicycle with transit, including bicycle access to major transit stops, bicycle parking at stops, and bicycle accommodations on board.

Congestion Management Program

As the County's Congestion Management Agency (CMA), VTA is responsible for managing the County's blueprint to reduce congestion and improve air quality. VTA is authorized to set State and federal funding priorities for transportation improvements affecting the Santa Clara County CMP transportation system. CMP designated transportation system components in Mountain View include a regional roadway network, a transit network, and a bicycle network. The CMP regional roadway network in Mountain View includes all State highways, County expressways, and some principal arterials, while the transit network includes rail service and selected bus service. The bicycle network focuses on the Cross County Bicycle Corridors, which is a network of 57 routes that are identified in the Santa Clara Countywide Bicycle Plan (Summer 2018). The long-range countywide transportation plan and how projects compete for funding and prioritization are documented in the *Valley Transportation Plan (VTP) 2040* (adopted in October 2015).

The Citywide Multimodal Improvement Plan (MIP), also referred to as the Deficiency Plan per the state's CMP legislation, is a planning document that identifies measures to improve transportation conditions on the CMP network without making physical traffic capacity expansions such as widening an intersection or roadway. The MIP identifies improvements that aid mobility by modes other than the automobile and how to improve the efficiency of the existing roadways. The MIP is based on the VTA Deficiency Plan Requirements, which describes the required content, actions, and implementation standards to assist Member Agencies with deficiency plan preparation and responsibilities.

City of Mountain View General Plan

The City of Mountain View General Plan 2030 includes mobility goals aimed to enhance travel by all modes by encouraging use by non-auto modes and thus reduce vehicle trips. The goals and policies include topics of complete streets, accessibility, walkability, bikeability, public transit, safe routes to school, vehicle parking, performance measurements, greenhouse gas emissions and air quality, and vehicles and roadway style efficiency. The goal and policies for the San Antonio Change Area are listed below:

Goal LUD-21: A gateway neighborhood with diverse land uses, public amenities and strong connections to surrounding areas.

- *Policies LUD 21.1:* A mix of land uses. Support a mix of commercial land uses serving the neighborhood and the region.
- *LUD 21.2:* Higher-density residential near transit. Encourage higher-density residential uses near bus and Caltrain stations.



- *LUD 21.3*: Improved connectivity. Promote improved connectivity to adjacent neighborhoods, destinations and Downtown.
- *LUD 21.4*: Improved pedestrian and bicycle circulation. Support improved pedestrian and bicycle circulation and connectivity throughout the area.
- *LUD 21.5*: Hetch Hetchy right-of-way. Promote the use of the Hetch Hetchy right-of-way for open space and mobility improvements in the area.
- **Goal LUD-22**: A revitalized San Antonio Center with a diverse mix of uses and connections to adjacent neighborhoods.
 - *LUD 22.1*: San Antonio Center transformation. Support the transformation of San Antonio Center into a regional mixed-use and commercial destination.
 - *LUD 22.2*: Residential uses. Support new residential uses within San Antonio Center.
 - *LUD 22.3*: Gathering spaces. Encourage new plazas, open space and other gathering spaces in the San Antonio Center.
 - *LUD 22.4*: Pedestrian-oriented design elements. Ensure that developments include pedestrian-oriented design elements such as accessible building entrances, visible storefronts and landscaping.
 - *LUD 22.5*: Finer street grid. Promote a finer street grid and improved connectivity within San Antonio Center.
 - *LUD 22.6*: Improved mobility. Support improved mobility within San Antonio Center for vehicles, transit, bicyclists and pedestrians.
 - *LUD 22.7*: Improved bicycle and pedestrian connections. Promote improved bicycle and pedestrian connections to the San Antonio Caltrain station, El Camino Real bus service, adjacent neighborhoods and the citywide bicycle and pedestrian network.
 - *LUD 22.8*: Parking area safety. Ensure safe pedestrian and bicycle access through parking areas.

The Mountain View General Plan also states the form and character for the San Antonio Change area Pedestrian and Bicyclist environment to be:

- Streets and paths for pedestrians and bicyclists established in the San Antonio Center.
- Large parcels include clear pedestrian, bicycle, and multi-modal roadway connections.
- Wide sidewalks and tree wells reinforce pedestrian-oriented, mixed-use setting.
- Hetch Hetchy right-of-way used as open space and a pedestrian and bicyclist connection.
- Pedestrian amenities such as plazas, street furniture and directional signs.
- Safe pedestrian and bicyclist crossings of busy streets.
- Bicycle parking in convenient and accessible locations around commercial destinations.
- Small curb radiuses and short street-crossing distances.



AccessMV: Comprehensive Modal Plan

AccessMV is a modal plan to provide a consistent vision for the City's multimodal transportation network. This plan aims to identify the City's primary transportation network for all modes and prioritizes previously identified transportation improvement projects. As part of this effort, the City is analyzing bicycle and pedestrian Level of Traffic Stress, pedestrian quality of service, and potential transit demand.

Mountain View Vision Zero Policy

On December 10, 2019, Mountain View City Council unanimously adopted a Vision Zero Policy to eliminate fatal traffic collisions in Mountain View by 2030. Vision Zero is an integrated set of policies, plans and programs based on the philosophy that fatal collisions are unacceptable and often preventable.

Mountain View's Vision Zero approach is to eliminate fatal and severe injury traffic collisions among all road users, including those walking, biking, and driving. This approach is working to eliminate fatal traffic collisions by 2030, working to decrease traffic collisions involving fatalities or severe injuries (KSI collisions) by 50 percent by 2030 from a 2016 baseline of 15 collisions; and working to decrease the three-year annual average number of people killed or severely injured (KSI) in collisions by 15 percent every three years from a current three-year annual average baseline of 19 people.

San Antonio Precise Plan

The San Antonio Precise Plan (SAPP) implements the goals and policies set forth in the City of Mountain View 2030 General Plan (General Plan) for the San Antonio Precise Plan Area (Plan Area). Using input gathered through a separate San Antonio visioning process and during the Precise Plan process, the Plan provides guiding principles, policies, development criteria and implementation strategies to coordinate private development and public improvements given the unique opportunities and characteristics of the Plan Area. The Plan is a regulatory document guiding how future development in the Plan Area will achieve the General Plan vision to transform the existing regional commercial area into a mixed-use core within a broader existing residential neighborhood, considering the area's proximity to transit services and location along two of the most heavily traveled corridors in the City: El Camino Real and San Antonio Road. The Plan also identifies opportunities to improve pedestrian and bicycle crossings at key locations in the Plan Area in the Intersection Design Standards and Key Intersection Improvements section. The Plan will require vehicular and bicycle parking consistent with the City's Zoning Ordinance parking standards.

The Plan area street network includes the following street types:

- **Major Public Streets.** These are the four vehicular corridors that bound the Center and provide access to/from the Plan Area. El Camino Real and San Antonio Road are high-volume roadways that serve as part of a regional commute corridor, while California Street and Showers Drive provide important local access to regional retail uses and transit services. This Plan proposes new or upgraded bicycle and pedestrian facilities on all these roadways.



- **Neighborhood Streets.** These streets are low to medium volume roadways that primarily provide connections to surrounding neighborhood areas for vehicles, bicycles, and pedestrians alike. This Plan primarily focuses on how future development will engage the street frontages.
- **Greenways.** Greenways are new publicly-accessible internal roadways along major open space areas proposed within the Center. The greenways provide vehicular access and on-street parking for internal retail uses, and serve as the primary bicycle and pedestrian corridors through the Plan Area.
- **Main Internal Streets.** Along with the Plan's greenways, these internal streets provide the main access to the Mixed-Use Center core. They are low speed facilities that provide pedestrian-oriented street frontages with landscaping and street furnishings.
- **Flexible Connections.** Flexible connections are used to implement this Plan's vision, policies and standards for better multi-modal connections and a more fine-grained network of streets. Flexible connections include both vehicle and non-vehicle roadways and may serve a variety of purposes such as delivery/loading corridors, pedestrian/bicycle-only pathways, and/or additional vehicle access. These connections may be configured in a variety of ways based on future development proposals and the functional needs. Regardless of their primary purpose, these connections are required to accommodate pedestrian and bicycle access.



3. Existing Conditions

This chapter describes the Existing Conditions of the roadway system, pedestrian and bicycle facilities, and transit service near the project site. It also presents existing traffic volumes and operations for the study intersections and freeway segments.

COVID-19 Note: The following Existing Conditions discussion describes conditions prior to the March 2020 shelter-in-place policy. Unless noted, the intersection counts that are used for this analysis were collected prior to the voluntary shelter-in-place policies implemented by several large technology firms beginning the first week in March 2020 and the formal shelter-in-place order issued by Santa Clara County Public Health Department on March 16, 2020 and last modified on June 21, 2021 to slow the spread of COVID-19.

Existing Street System

US 101, El Camino Real, and San Antonio Road provide regional access to the project site. The following streets provide local access: Middlefield Road, Central Expressway, California Street, Showers Drive, and Rengstorff Avenue. Each access facility is described below in more detail.

US 101 is a north-south freeway located north of the project site with five travel lanes in each direction. Two travel lanes in each direction are designated as a high-occupancy vehicle (HOV) lane, beginning approximately 1 mile north (near Oregon Expressway) of the study area through the US 101/SR 85 interchange. One HOV lane and four travel lanes in each direction are present outside of this area in Santa Clara County between East Bayshore Road (in Redwood City) and Cochrane Road (in Morgan Hill). HOV lanes, also known as diamond or carpool lanes, are limited to use by vehicles occupied by two or more persons Monday through Friday between 5:00 AM and 9:00 AM, and between 3:00 PM and 7:00 PM. US 101 extends north through San Francisco and south through San Jose and Gilroy. Access to the project site from US 101 is via San Antonio Road.

El Camino Real/SR 82 is a six-lane north-south (alignment is east-west in the project area) major arterial that extends from The Alameda in Santa Clara to Market Street in Daly City. El Camino Real is parallel to US 101 and I-280 provides a connection between cities. El Camino Real provides access to residential, commercial and office developments. The posted speed limit is 35 mph.

San Antonio Road is a two- to six-lane, north-south arterial road that extends from Foothill Expressway in the south (within Los Altos) to the Shoreline at Mountain View Regional Park. San Antonio Road provides access to residential, commercial and office developments. The posted speed limit near the project site is 35 mph.

Middlefield Road is a four-lane, east-west arterial street that extends from Central Expressway to SR 85, as West Middlefield Road from SR 85 to San Antonio Road, and as Middlefield Road from San Antonio Road



to Jefferson Avenue in Redwood City. Middlefield Road provides access to local residential streets as well as to light industrial and commercial developments. The posted speed limit on Middlefield Road within the project area is 35 mph.

Central Expressway is a four- to six-lane east-west expressway which extends from the City of Santa Clara in the east to San Antonio Road in the west where it continues as Alma Street into the City of Palo Alto. In Mountain View, it runs on the north side of the Caltrain railroad tracks with limited connections to the south side of the railroad tracks at Castro Street/Moffett Boulevard, Shoreline Boulevard, and Rengstorff Avenue. Central Expressway has limited access to adjacent parcels because it is designed as an expressway. The posted speed limit on Central Expressway is 45 mph.

California Street is a four-lane local street adjacent to the project site that extends between Del Medio Avenue to the west and Bush Street to the east. California Street provides access to residential, commercial and office developments. The posted speed limit is 35 mph.

Showers Drive is a four-lane local street to the east of the project site that extends north from El Camino Real to become San Antonio Circle where it crosses underneath San Antonio Road. Showers Drive provides access to residential, and commercial developments. The posted speed limit near the project site is 35 mph.

Rengstorff Avenue is a four-lane local street to the east of the project site that extends between El Camino to the south and Charleston Road to the north, where it becomes Amphitheatre Parkway. Rengstorff Avenue provides access to residential, commercial and office developments. The posted speed limit is 35 mph.

Existing Truck Routes

The City of Mountain View Municipal Code section 19.60 designates truck routes within the City limits. The designated truck routes within the study area are: Central Expressway, El Camino Real, and San Antonio Road.

Existing Pedestrian Facilities

All streets immediately adjacent to the project site have sidewalks. Most sidewalks are 5 to 12 feet wide, and many sidewalks have a landscaping strip separating the sidewalk from the street. Certain streets within the project area do not have sidewalks, including the eastbound segment of Central Expressway within the project area and San Antonio Road where it crosses Central Expressway. Pedestrian desiring to cross Central Expressway can use the path and crosswalks that are accessible from the Caltrain Station. All major intersections near the project site have crosswalks.

The locations of the existing pedestrian facilities are shown on **Figure 3**.



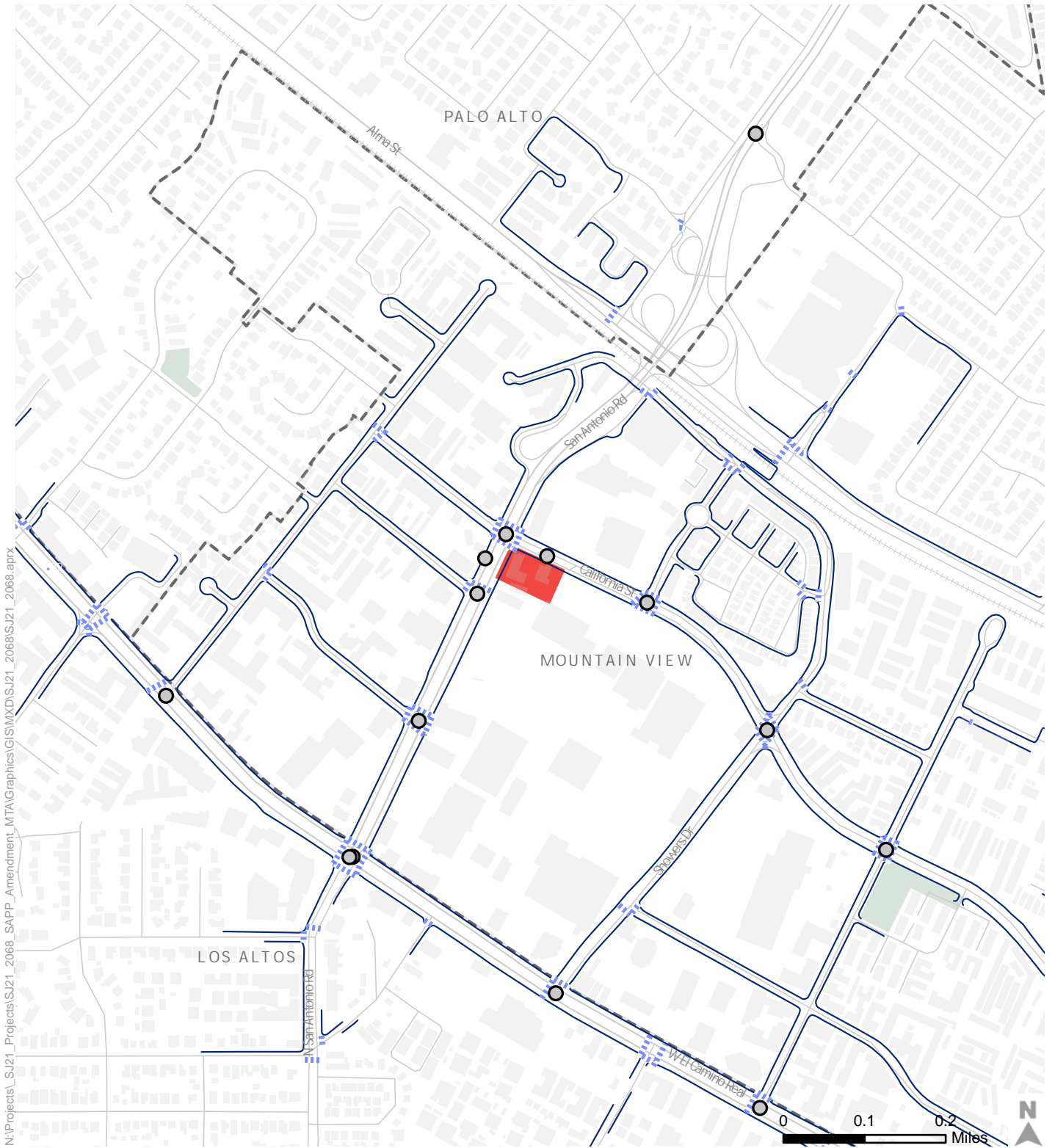

N:\Projects\SJ21_Projects\SJ21_2068_SAPP_Amendment\MTA\Graphics\GIS\WXD\SJ21_2068\SJ21_2068.aprx

- Project Site
- City Boundaries
- Study Intersections
- Crosswalks
- Sidewalks

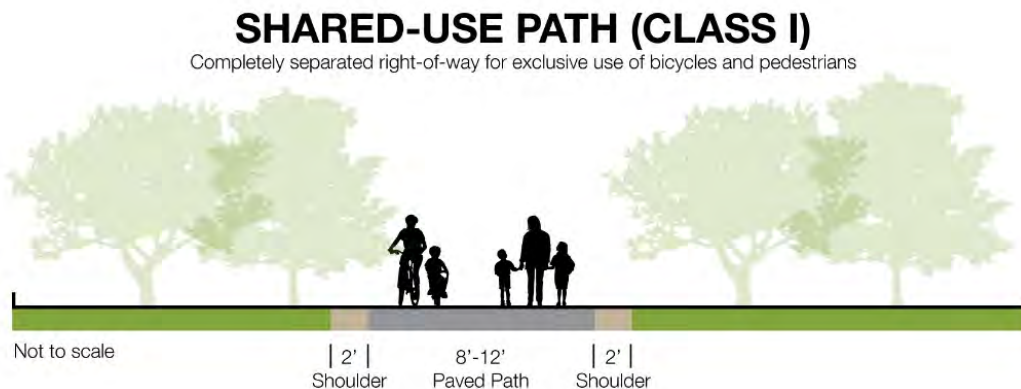

Figure 3
Existing Pedestrian Facilities

Existing Bicycle Network

The four classes of bicycle facilities in Mountain View are described in the *Mountain View Bicycle Transportation Plan Update* (MVBTP Update, 2015). These descriptions are based on California Department of Transportation (Caltrans) classifications of bikeways from California Assembly Bill 1193 and the *Highway Design Manual* (Chapter 1000: Bikeway Planning and Design). Each bikeway class is intended to provide bicyclists with enhanced riding conditions. Bikeways offer various levels of separation from traffic based on traffic volume and speed, among other factors. The four bikeway types and appropriate contexts for each are presented below.

Class I Bikeway (Shared Use Path) Shared-use paths, sometimes referred to as multi-use paths, provide a separate right-of-way and are designated for the exclusive use of people riding bicycles and walking with minimal roadway crossings. In general, bike paths are along corridors not served by streets or where sufficient right-of-way exists to allow them to be constructed away from the influence of vehicles. Mountain View has many such paths located along creeks and the light rail line. Class I Bikeways can also offer opportunities not provided by the road system by serving recreational areas and/or desirable commuter routes.



Class II Bikeways (On-Street Bike Lanes) Bike lanes provide a striped lane, pavement markings, and signage for one-way bike travel on a street or highway. Bicycle lanes are typically five (5) feet wide, although wider lanes are desirable on roadways with high traffic volumes and/or high travel speeds. The *VTA Bicycle Technical Guidelines* (December 2007) recommends that Caltrans standards regarding bicycle lane dimensions be used as a minimum and provides supplemental information and guidance on when and how to better accommodate the many types of bicyclists. Bike lanes may be enhanced with painted buffers between vehicle lanes and/or parking, and green paint at conflict zones (such as driveways or intersections).



BICYCLE LANE (CLASS II)

On-street striped lane for one-way bike travel

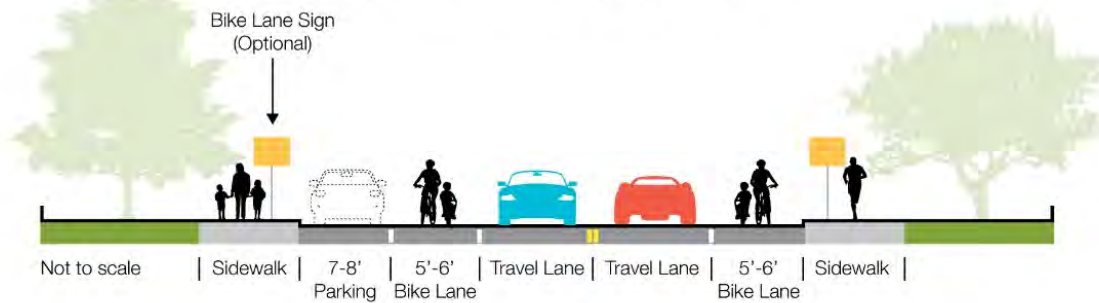

Class IIIa Bikeways (Bike Routes) Bike routes may be identified on a local residential or collector street when the travel lane is wide enough and the traffic volume is low enough to allow both cyclists and motor vehicles to share a lane and/or to provide continuity to a bikeway network. Shared-use arrows or “sharrows” are common striping treatments for bike routes.

Class IIIb Bikeways (Bike Boulevards) Bicycle boulevards provide further enhancements to bike routes to encourage slow speeds and discourage non-local vehicle traffic via traffic diverters, chicanes, traffic circles, and/or speed tables. Bicycle boulevards can also feature special wayfinding signage to nearby destinations or other bikeways.

BICYCLE ROUTE (CLASS III)

Shared on-street facility

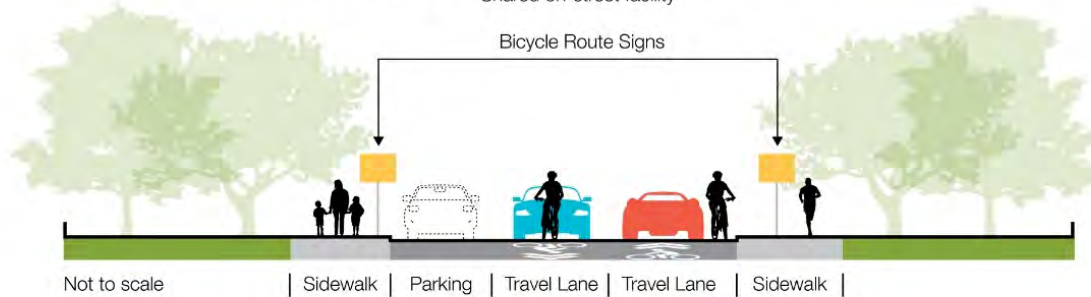

Class IV Bikeways (Separated Bikeway) Separated bikeways, also referred to as cycle tracks or protected bikeways, are bikeways for the exclusive use of bicycles which are physically separated from vehicle traffic. Separated bikeways were recently adopted by Caltrans in 2015. Types of separation may include, but are not limited to, grade separation, flexible posts, physical barriers, or on-street parking.



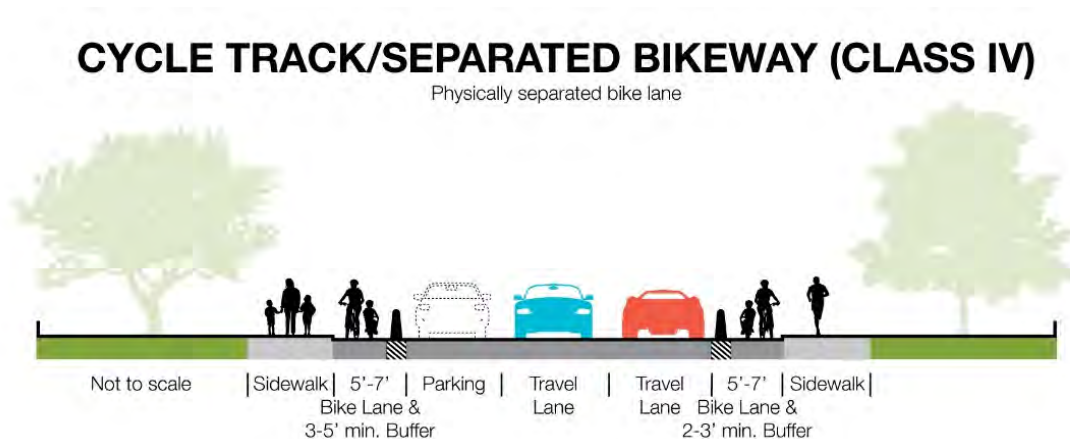

Under California Law, bicyclists are allowed to use all roadways in California unless posted otherwise. Therefore, even for roadways that have no (or planned) bikeway designation identified, a majority are open for cycling.

The locations of the existing bicycle facilities are shown on **Figure 4** and existing bicycle volumes are presented on **Figure 5**. As described above, Class I bikeways are off-street multi-use (pedestrian and bicycle) paths that are separated from roadways to create a safer, convenient, and more connected walking and biking environment.

The *SAPP* identifies new planned bike facilities and improvements to existing facilities. This proposal includes the addition of Class II facilities to San Antonio Road, Class III facilities to the Hetch Hetchy Greenway within San Antonio Center, and Class IV facilities to California Street and Showers Drive. Roadways designated as neighborhood streets in the *SAPP*, including Fayette Drive, Latham Street, Pacchetti Way, Miller Avenue, San Antonio Circle, and California Street west of San Antonio Road, have optional Class II bicycle facility improvements listed in the *SAPP*.

Existing Transit Service

Bus and light rail service in Mountain View are operated by the VTA. Commuter rail service (Caltrain) is operated from San Francisco to Gilroy by the Peninsula Joint Powers Board. The Mountain View Community Shuttle is operated jointly by the City of Mountain View and Google. MVgo is operated by the Mountain View Transportation Management Association, a nonprofit organization established and funded by various Mountain View businesses and landowners. **Table 1** summarizes the existing transit services for the project. The bus routes, bus stops, LRT line, LRT stations, and Caltrain station are illustrated on **Figure 6**. It is approximately 4,200 feet (an eighteen-minute walk) from the Middlefield Station.



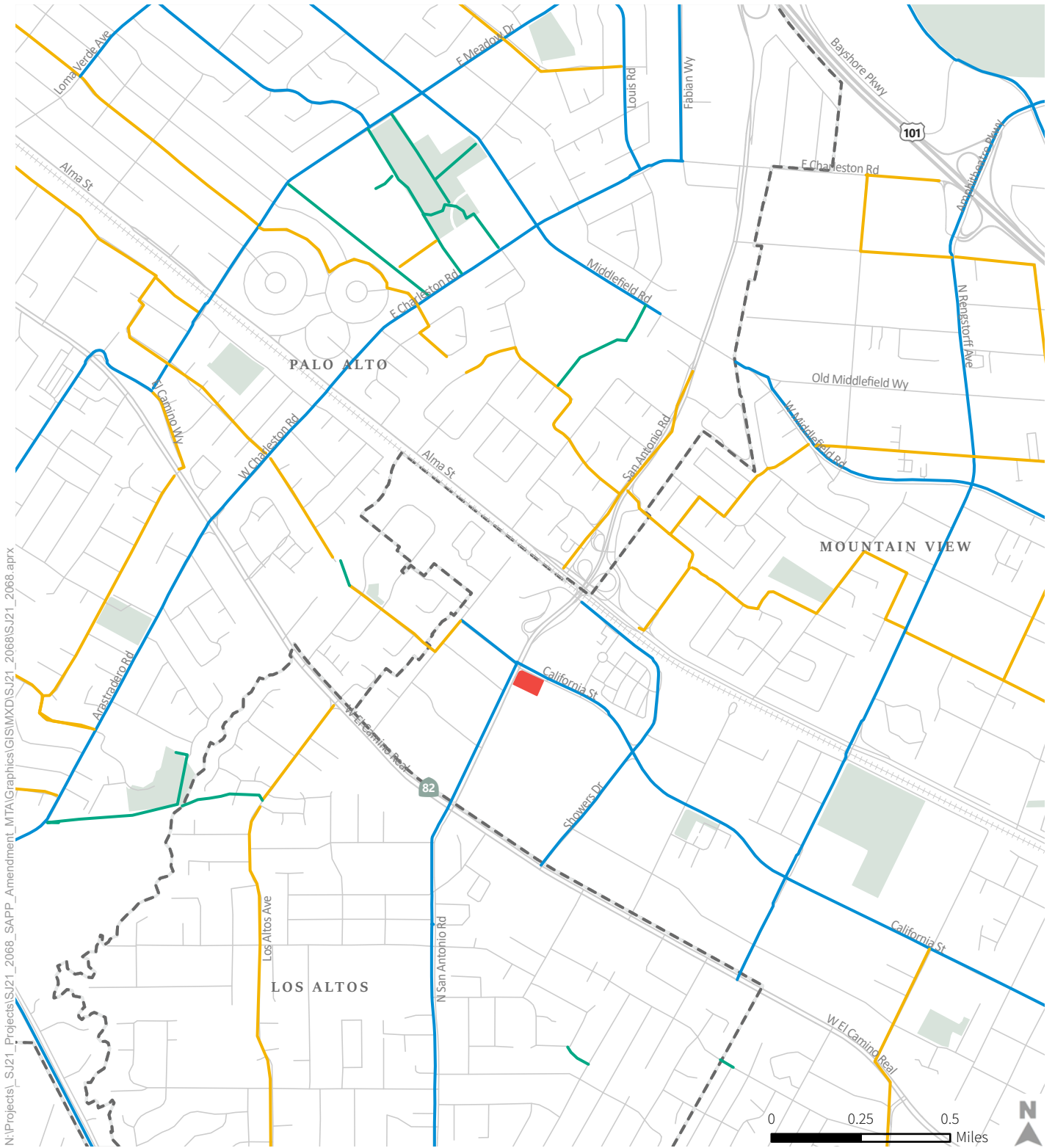
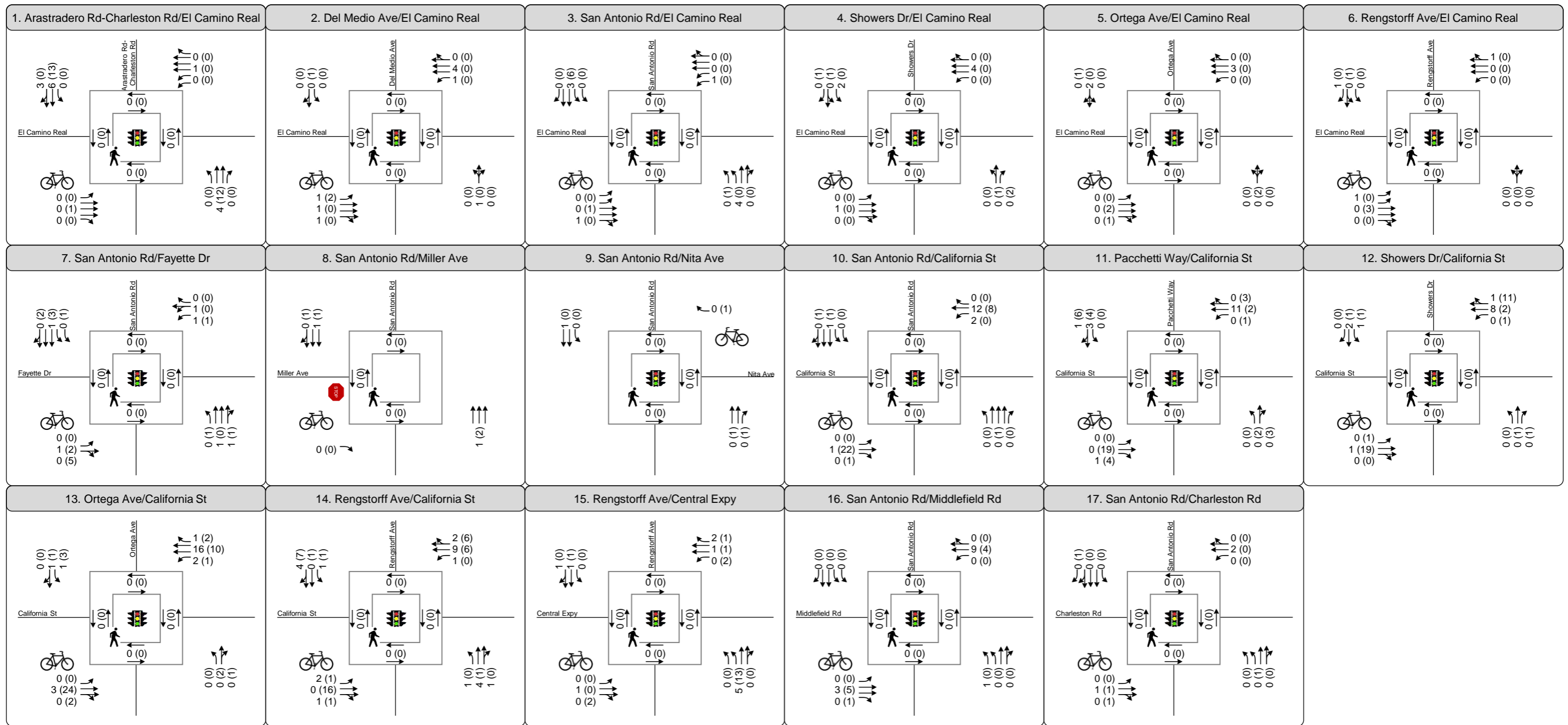

Figure 4
Existing Bike Facilities





Turn Lane
 Traffic Signal
 Stop Sign
 AM (PM) Peak Hour Traffic Volume

Existing Bicycle and Pedestrian Volumes

Table 1: Existing Transit Services

Route ¹	From	To	Weekdays		Weekends	
			Operating Hours	Peak Headway ² (minutes)	Operating Hours	Headway ² (minutes)
VTA Bus Service						
21	Stanford Shopping Center	Santa Clara Transit Center	5:30 AM – 9:30 PM	30	8:00 AM-8:00 PM Sat (9:00 AM-8:00 PM Sun)	45 Sat (60 Sun)
22	Palo Alto Transit Center	Eastridge Transit Center	4:30 AM – 1:50 AM	20	4:50 AM-2:00 AM Sat (4:55 AM-1:10 AM Sun)	20 Sat (30 Sun)
40	Foothill College	Mountain View Transit Center	6:00 AM – 8:30 PM	55	8:20 AM-6:30 PM Sat (9:00 AM-6:00 PM Sun)	50 Sat (45 Sun)
522	Palo Alto Transit Center	Eastridge Transit Center	5:20 AM – 11:15 PM	20	6:00 AM-10:20 PM Sat (6:55 AM – 9:25 PM)	20 Sat (20 Sun)
Mountain View Community Shuttle						
Mountain View Community Shuttle	Loop throughout the City of Mountain View		10:00 AM – 6:00 PM	30	10:00 AM – 6:00 PM	60
MVgo Routes C/D	Loop throughout the City of Mountain View (including North Bayshore via Charleston Road) ³		6:10 AM – 10:45 AM and 2:50 PM – 8:15 PM	30-60	N/A	N/A
Caltrain Passenger Rail						
Caltrain	San Francisco	Gilroy	4:30 AM – 1:30 AM	20-40	7:30 AM - 1:40 AM	60

Notes:

1. Weekday and weekend service as of May 2021.
2. Headways are defined as the time between transit vehicles on the same route (e.g., time between two Route 21 buses stopping at the Showers Drive and Latham Street intersection bus stops).
3. MVgo buses pass the project site on San Antonio Road but do not stop near the project site.

Sources: Fehr & Peers, 2021.



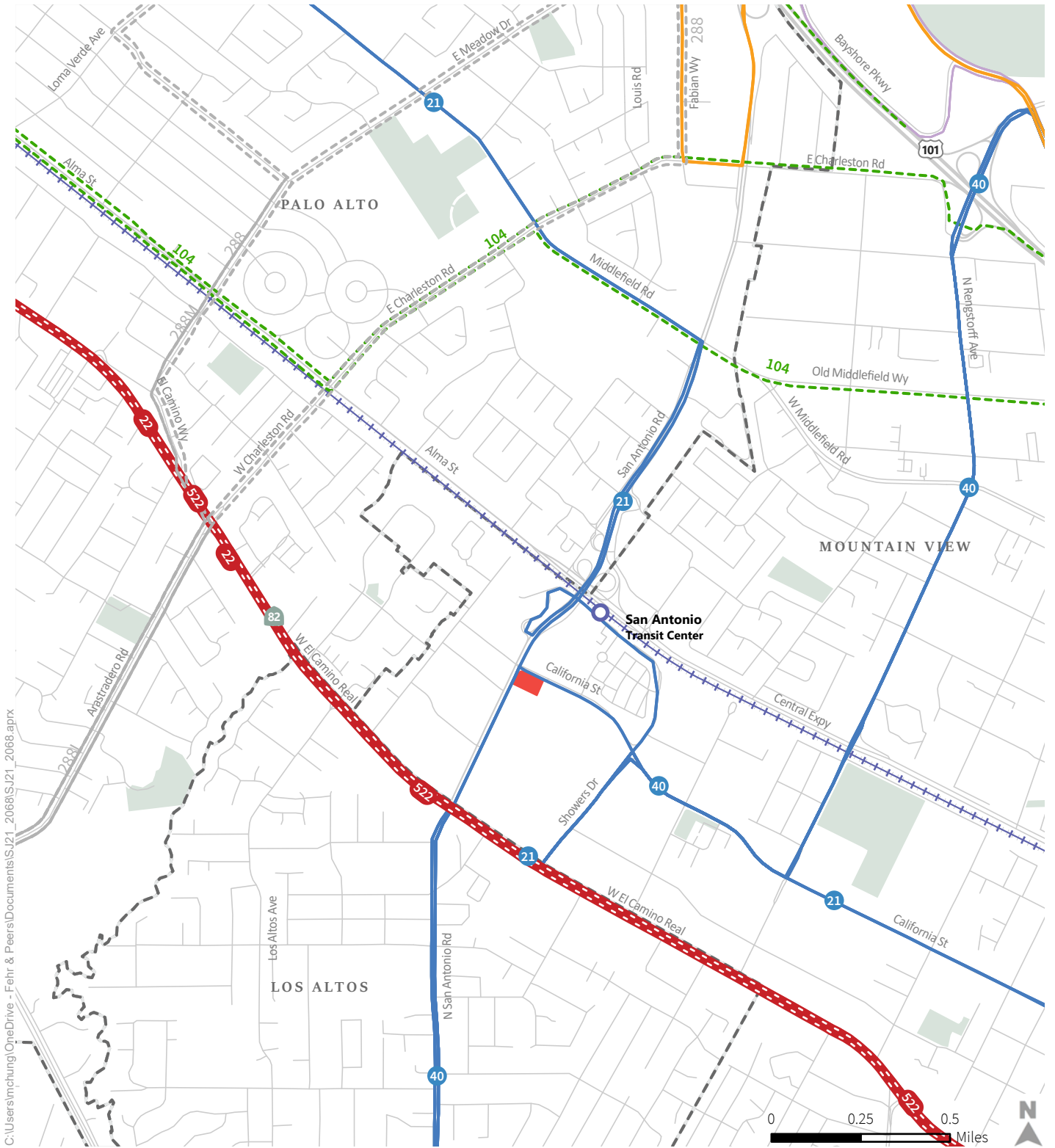

- Project Site
- City Boundaries
- Rapid Bus
- Express Bus
- Local Bus
- School Service
- ACE Orange Shuttle
- MVGo Route
- + Caltrain Line
- Caltrain Station

Figure 6
Existing Transit Facilities



Existing Intersection Volumes Approach

Typically, new traffic counts are collected at all study intersections for traffic analyses to evaluate a recent Existing Conditions. However, due to the COVID-19 pandemic, local jurisdictions and large regional employers have recommended that all employees work from home if possible. As a result, traffic volumes at all study intersections are lower-than-typical and new turning movement counts cannot be directly used for analysis.

The City of Mountain View allows the use of historical turning movement counts if they are less than two years old. For this analysis, City staff has identified that counts collected between February 2019 and March 2020 (when the first regional Shelter-in-Place orders were issued) may be used. Historical turning movement counts were obtained for Intersection #3 (El Camino Real and San Antonio Road) and Intersection #7 (San Antonio Road and Fayette Drive) because these counts were collected in November 2019 and October 2019, respectively.

New traffic counts collected at all study intersections in April 2021. At Intersection #3 and Intersection #9, historical counts were compared to new counts to yield a growth factor between typical traffic patterns and traffic patterns affected by COVID-19 conditions. This growth factor was applied to all intersections where no historical turning movement counts were available to represent typical pre-COVID-19 traffic patterns. Based on this approach, a factor of 1.84 was applied to AM peak hour volumes and a factor of 1.66 was applied to PM peak hour volumes. **Appendix A** contains the unadjusted turning movement counts, and **Appendix B** contains the volume adjustment calculations and the corresponding adjusted volumes for the applicable study intersections.

Existing Intersection Operations

Existing intersection lane configurations, signal timings, and peak hour turning movement volumes were used to calculate the levels of service for the study intersections during the AM and PM peak hours. The results are presented in **Table 2**. **Appendix C** contains the corresponding LOS calculation sheets (for all the study scenarios). The traffic analysis methods used in this section are described in more detail in **Chapter 6**.

The results of the LOS calculations indicate that all the study intersections are operating at acceptable levels under Existing Conditions.

The existing lane configurations, traffic controls, and peak hour traffic volumes are shown in **Figure 7**.



Table 2: Existing Intersection Levels of Service

	Intersection	Count Date	LOS Threshold	Control ¹	Peak Hour ²	Delay ³	LOS ^{4,5}
1	El Camino Real and Arastradero Road-Charleston Road (PA)*	April 2021 ⁵	LOS E	Signal	AM PM	33.8 40.9	C- D
2	El Camino Real and Del Medio Avenue (MV)	April 2021 ⁵	LOS D	Signal	AM PM	20.2 13.2	C+ B
3	El Camino Real and San Antonio Road (MV)*, **	November 2019	LOS E	Signal	AM PM	33.1 51.6	C- D-
4	El Camino Real and Showers Drive (MV)**	April 2021 ⁵	LOS E	Signal	AM PM	23.1 26.8	C C
5	El Camino Real and Ortega Avenue (MV)	April 2021 ⁵	LOS D	Signal	AM PM	15.9 12.4	B B
6	El Camino Real and Rengstorff Avenue (MV)*	April 2021 ⁵	LOS E	Signal	AM PM	17.2 29.4	B C
7	Fayette Drive and San Antonio Road (MV)**	October 2019	LOS E	Signal	AM PM	15.6 19.9	B B-
8	Miller Avenue and San Antonio Road ⁵ (MV)**	April 2021 ⁵	LOS E	Side-Street Stop Controlled	AM PM	11.6 11.5	B B
9	Nita Avenue and San Antonio Road (PA)	April 2021 ⁵	LOS D	Signal	AM PM	8.7 4.8	A A
10	California Street and San Antonio Road (MV)**	April 2021 ⁵	LOS E	Signal	AM PM	37.4 57.7	D+ E+
11	California Street and Pacchetti Way (MV)**	April 2021 ⁵	LOS E	Signal	AM PM	25.2 24.5	C C
12	California Street and Showers Drive (MV)**	April 2021 ⁵	LOS E	Signal	AM PM	31.1 31.8	C C
13	California Street and Ortega Avenue (MV)	April 2021 ⁵	LOS D	Signal	AM PM	26.1 19.5	C B-
14	California Street and Rengstorff Avenue (MV)	April 2021 ⁵	LOS D	Signal	AM PM	31.2 34.2	C C-
15	Central Expressway and Rengstorff Avenue (SCC)	April 2021 ⁵	LOS E	Signal	AM PM	29.8 67.2	C E
16	Middlefield Road and San Antonio Road (PA)*	April 2021 ⁵	LOS E	Signal	AM PM	51.4 55.0	D- E+
17	Charleston Road and San Antonio Road (PA)*	April 2021 ⁵	LOS E	Signal	AM PM	34.0 48.1	C- D
18	Project Driveway and San Antonio Road (MV)**	N/A ⁶	LOS E	Stop Controlled Driveways	AM PM	10.6 11.9	B B
19	Project Driveway and California Street (MV)**	N/A ⁶	LOS E	Stop Controlled Driveways	AM PM	9.7 11.6	A B

Notes: (see next page)



Bold text indicates intersection operates at an unacceptable Level of Service compared to the applicable standard.

PA = Palo Alto; MV = Mountain View; SCC = Santa Clara County; * = Congestion Management Program Intersection; and ** = San Antonio Center Planning Area Intersection.

1. Signal refers to a signalized intersection. SSSC = Side-Street Stop Controlled intersection.
2. AM = morning peak hour, PM = evening peak hour
3. Whole intersection weighted average control delay expressed in seconds per vehicle calculated using methods described in the 2000 Highway Capacity Manual, with adjusted saturation flow rates to reflect Santa Clara County Conditions for signalized intersections. For side-street stop-controlled intersections total delay for the worst approach is reported.
4. LOS = Level of Service. LOS calculations conducted using the TRAFFIX level of service analysis software package, which applies the method described in the *2000 Highway Capacity Manual*.
5. Turning movement counts collected in April 2021 reflect atypical traffic patterns caused by the regional shelter-in-place orders due to the COVID-19 pandemic. As described in the text, the April 2021 counts were adjusted to reflect typical traffic patterns by comparing them to recent turning movement counts collected before the regional shelter-in-place orders.
6. Turning movement counts were not collected for study intersections #18 and #19, which are the project driveways. The California Street volume is estimated from the eastbound departure value of the adjacent study intersection #10 (California Street and San Antonio Road), and driveway volumes were estimated using trip generation values and network trip assignments from *The Village at San Antonio Center (Phase 2) – Final Transportation Impact Analysis* (2014).

Source: Fehr & Peers, 2021.



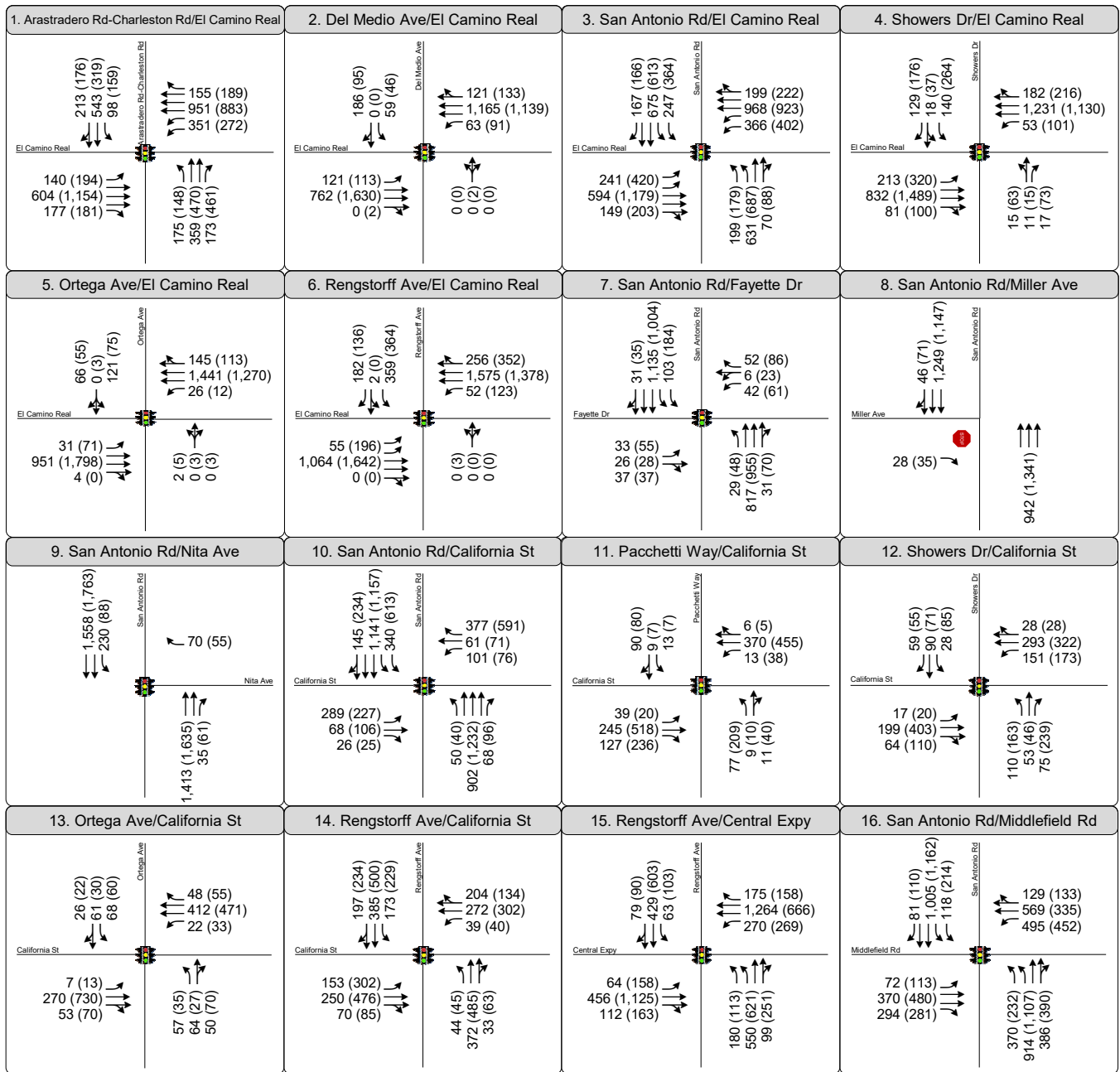

Figure 7

Existing Lane Configuration, Traffic Control, and Peak Hour Traffic Volumes



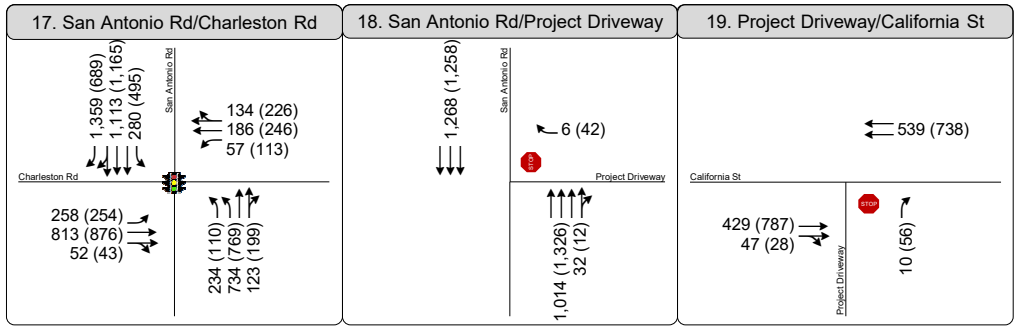

Figure 7

Existing Lane Configuration, Traffic Control, and Peak Hour Traffic Volumes



Existing Freeway Segment Operations

The results of the freeway LOS analysis for Existing Conditions are shown in **Table 3**: Existing Freeway Segment Levels of Service for mixed-flow and HOV lanes. HOV lanes are carpool lanes restricted to only vehicles with 2 or more persons, while mixed-flow lanes, or mixed lanes, include HOV and single occupancy vehicles. For mixed-flow lanes, freeway segment capacities are defined as 2,200 vehicles per hour per lane (vphpl) for four-lane freeway segments and 2,300 vphpl for six-lane freeway segments. HOV lane capacities are defined as 1,650 vphpl.

Table 3: Existing Freeway Segment Levels of Service

Freeway Segment	Capacity ¹		Peak Hour ¹	Lanes		Level of Service ²	
	MF ³	HOV ³		MF ³	HOV ³	MF ³	HOV ³
US 101 – Southbound							
Oregon Expressway to San Antonio Road	6,900	3,300	AM	3	2	D	A
			PM	3	2	F	D
San Antonio Road to Rengstorff Avenue	6,900	3,300	AM	3	2	E	A
			PM	3	2	F	D
Rengstorff Avenue to Shoreline Boulevard	6,900	3,300	AM	3	2	D	C
			PM	3	2	F	D
Shoreline Boulevard to SR 85	6,900	1,650	AM	3	1	D	A
			PM	3	1	F	E
US 101 – Northbound							
SR 85 to Shoreline Boulevard	9,200	3,300	AM	4	2	F	E
			PM	4	2	F	D
Shoreline Boulevard to Rengstorff Avenue	9,200	3,300	AM	4	2	F	D
			PM	4	2	F	D
Rengstorff Avenue to San Antonio Road	6,900	3,300	AM	3	2	E	D
			PM	3	2	F	D
San Antonio Road to Oregon Expressway	6,900	3,300	AM	3	2	F	E
			PM	3	2	F	F

Notes:

1. AM = morning peak hour (between 7:00 and 9:00 AM), PM = evening peak hour (between 4:00 and 6:00 PM).
2. Level of service based on density.
3. MF = Mixed-Flow Lanes, HOV = High-Occupancy Vehicle Lanes

Bold text indicates unacceptable operations by jurisdiction level of service standard (LOS F for CMP-designated facilities).

Source: 2018 CMP Monitoring & Conformance Report, VTA, November 2020; Fehr & Peers, 2021.

As shown, many segments are currently operating unacceptably. Near the project site during the morning peak hour, northbound US 101 operates unacceptably from SR 85 to Rengstorff Avenue and from San Antonio Road to Oregon Expressway for the mixed-flow lanes. During the evening peak hour, US 101 northbound and southbound operate unacceptably for every freeway segment near the project site for



the mixed-flow lanes. Additionally, the US 101 northbound HOV lanes operate unacceptably from San Antonio Road to Oregon Expressway.

Field Observations

Due to the COVID-19 pandemic and the resulting shelter-in-place order in March 2020, current traffic operations do not adequately reflect typical traffic patterns. Therefore, it was not possible to make field observations of existing traffic patterns, including vehicle delays and queues. However, the traffic operations reported above align with those we have historically seen prior to the COVID-19 pandemic.

Field observations were conducted to verify existing lane geometries, signal controls, bicycle facilities, pedestrian facilities, and transit facilities near the project site.



Site Access and Circulation



4. Site Access and On-Site Circulation

This chapter provides an evaluation of the project's site access and internal circulation for pedestrians, bicyclists, and vehicles, and consistency with the San Antonio Precise Plan's mobility policies, standards and guidelines based on the site plan presented in **Figure 8**.

Pedestrian Access and Circulation

The site plan was evaluated for internal circulation within the project and access to transit uses near the site. The project will add pedestrian trips to the existing sidewalk network from employees who walk to and from work to nearby retail and residential land uses, who walk to nearby bus stops and the San Antonio Caltrain station, and who walk to and from other destinations in the area.

The *SAPP* identifies several policies that relate to pedestrian access and circulation, including:

- *CIRC-1.2*: Implement an integrated network of publicly accessible complete streets, balancing vehicle access needs with required improvements for pedestrians and bicyclists to improve the circulation system.
- *CIRC-1.3*: Improve access through the Plan Area with a walkable, small block, grid-like system of publicly accessible streets and connections.
- *CIRC-1.5*: Provide pedestrian facilities on all internal streets and connections.
- *CIRC-2.1*: Prioritize pedestrian and bicycle connections to provide efficient access to transit stations and open space areas, between commercial destinations, and in active frontage locations.
- *CIRC-2.2*: Provide pedestrian and bicycle intersection crossing improvements to existing conditions at the time of Plan adoption.

As presented in **Figure 8**, the proposed pedestrian paths throughout the site provide access to the frontages of California Street and San Antonio Road, and to the adjacent San Antonio Village Phase II buildings to the south and to the east. Additionally, the pedestrian paths provide connectivity to the sidewalks on San Antonio Road and California Street. The pedestrian facilities within the project site are consistent with the goals and policies outlined in the *SAPP*.

Bicycle Access and Circulation

The site plan was evaluated for internal circulation within the project, which will primarily add bicycle trips to the existing bicycle network from employees to bike to and from work to nearby retail and residential uses, and those who take transit (primarily bus or Caltrain) then bike to work.

The *SAPP* identifies several policies that relate to bicycle access and circulation, including:



- *CIRC-1.2*: Implement an integrated network of publicly accessible complete streets, balancing vehicle access needs with required improvements for pedestrians and bicyclists to improve the circulation system
- *CIRC-2.1*: Prioritize pedestrian and bicycle connections to provide efficient access to transit stations and open space areas, between commercial destinations, and in active frontage locations
- *CIRC-2.2*: Provide pedestrian and bicycle intersection crossing improvements to existing conditions at the time of Plan adoption.

The project does not propose any new onsite or off-site bicycle pathways. Signs will be posted at the project driveways directing bicyclists to dismount and walk their bikes around the project site. The project includes new indoor, secure bicycle parking facilities. Bicyclists would access the bicycle storage room via building access at the southeast corner on the intersection of San Antonio Road and California Street.

Vehicle Access and Circulation

As presented in **Figure 8**, the project site will have one two-way drive aisle around the south and east perimeter of the site. The drive aisle can be accessed via driveways on northbound San Antonio Road and eastbound California Street. Both project driveways are stop controlled right-turns-in and right-turns-out only driveways. The medians on California Street and San Antonio Road prevent left-turns out and left-turns in for these driveways. Posting of right-turn only signs on the driveway approach or a one-way sign on the median will help guide drivers onto the public streets. Additionally, the channelizing median nose for the eastbound California left-turn lane at the project driveway will be extended west to further inhibit the access of the left-turn lane from the driveway. Consistent with the *SAPP* goals for internal streets, the drive aisle will have a maximum speed limit of 15 miles-per-hour.

Off-street parking is provided on the south side of the two-way drive aisle between the new office building and San Antonio Village Phase II and are available to all users.

Emergency and Service Vehicle Access

Service Vehicles

The *SAPP* defines several policies and practices related to the circulation and management of service vehicles, including:

- *PTDM-1.4*: Locate garage and service bay openings in alleys and at the rear of buildings; and
- Use landscaping to screen less attractive elements, including loading, service, and delivery areas.

As shown on **Figure 8**, the project proposes one two-way drive aisle around the south and east perimeter of the site. Service vehicles may enter the project site via either California Street or San Antonio Road to access the site's loading area, which is on the south side of the building area.



Emergency Vehicles

Emergency vehicle turning maneuvers will need to be confirmed for entrance into the project at both driveways and circulation through the project for right turns into and out of both project driveways. The fire access route for the project is shown on **Figure 8**.



PHASE III ENLARGEMENT PLAN - PROPOSED IMPROVEMENTS

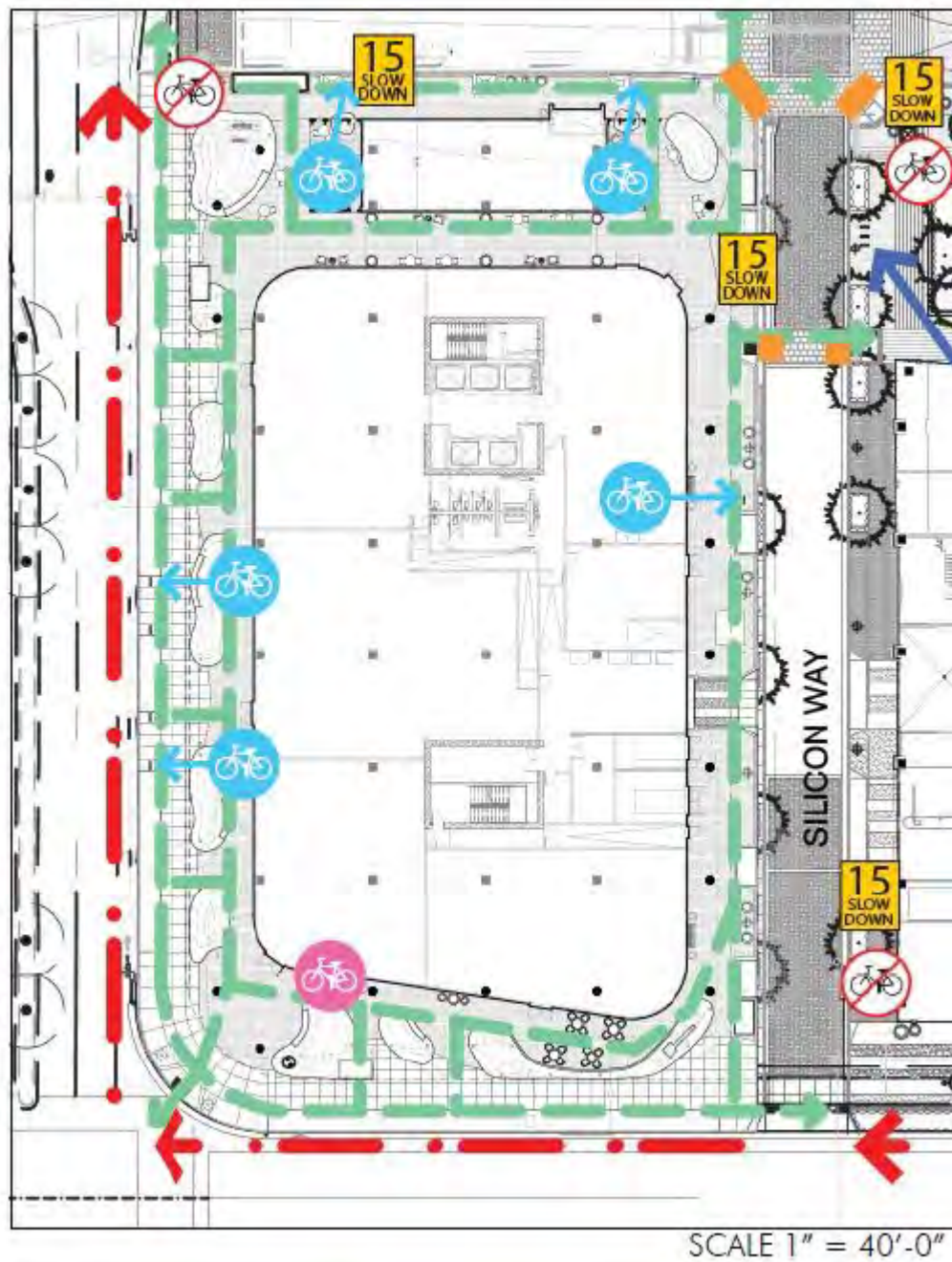

PHASE III ENLARGEMENT PLAN PROPOSED IMPROVEMENTS KEY

	BIKE STORAGE FOR SAFE & SECURE STORAGE OF BICYCLES IN BUILDING GARAGE (TYPE I BICYCLE PARKING)
	TYPE II BICYCLE PARKING
	"SLOW DOWN" 15 MPH SPEED LIMIT SIGN
	EXISTING BIKE LANE
	"WALK YOUR BIKE" PAVEMENT STENCIL AT HANDICAP RAMP
	"PED ZONE - WALK YOUR BIKE" POLE SIGN
	PEDESTRIAN CIRCULATION

N:\Projects\SJ21_Projects\SJ21_2068_SAPP_Amendment_MTA\Graphics\GIS\MXD\SJ21_2068\SJ21_2068.aprx



Figure 8
Circulation Plan

Vehicle Miles Traveled Summary



5. Vehicle Miles Traveled Summary

How transportation impacts under CEQA are analyzed was changed with Senate Bill (SB) 743. Passage of SB 743 removed the use of automobile delay or traffic congestion for determining transportation impacts in environmental review. Instead, the latest *CEQA Statute & Guidelines* now specify that vehicle miles traveled, or VMT, is the appropriate metric to evaluate transportation impacts on the environment. In short, SB 743 changes the focus of transportation impact analysis in CEQA from measuring impacts to drivers, to measuring the impact of driving.

Background Discussion

To comply with these new rules, the City of Mountain View adopted (June 2020) a set of VMT methods and procedures that are applied to land use projects in the City and provides additional direction in the *Multi-Modal Transportation Analysis Handbook* (February 2021). The guidelines specify use of the Santa Clara Countywide VMT Evaluation Tool ([SCC VMT Tool](#)) web application to conduct baseline VMT screening and VMT reduction analysis for small to medium size land use projects. Tool is used to perform multiple functions, such as:

- Screening projects from further VMT analysis
- Estimating the project generated VMT rate
- Estimating VMT reductions from TDM strategies

The types of land use projects addressed by the tool include the following:

- Residential, office, or industrial land uses
- Any of the land uses above in combination with each other
- Any of the land uses above combined with local-serving retail space

The SCC VMT Tool uses VMT data produced from the most recent run of the Santa Clara Valley Transportation Authority (VTA)-City/County Association of Governments of San Mateo County (C/CAG) Bi-County Model ("VTA Travel Model"). The SCC VMT Tool is designed to evaluate VMT for a small to medium-sized land use project in a single location.

Overall Approach

The home-based work vehicle miles traveled per employee rate is provided for informational purposes in this chapter because the *City of Mountain View San Antonio Precise Plan Environmental Impact Report* (SAPP EIR) (December 2014) already disclosed the potential effects of the project on the natural and human environment. After the certification of the SAPP EIR, the regulatory environment was changed by an update of the *California Environmental Quality Act Statutes and Guidelines* (December 2018) to require the use of VMT to identify potential transportation effects on the natural and human environment. As has



been the practice for many years, the SAPP EIR already included VMT as an input into the air quality, greenhouse gas analysis and energy sections of the SAPP EIR to disclose the potential effects of the project on the environment. Therefore, the following baseline home-based work VMT per employee screening results from the SCC VMT Tool is presented for informational purposes only.

For this baseline VMT screening assessment, the home-based work VMT per employee is the metric used to determine if the project is in a low VMT generating area and what VMT mitigation measures may be needed. Home-based work VMT per employee is used to evaluate if the VMT rate due to the project is greater than a specified VMT threshold. In this case, the threshold is defined as 15 percent below the nine-Bay Area County home-based work VMT per employee baseline under Existing Conditions. This analysis approach does not evaluate all VMT generated by the project.

For this baseline VMT screening assessment, the home-based work VMT per employee is the metric used to determine if the project is in a low VMT generating area and what VMT mitigation measures may be needed. Home-based work VMT per employee is used to evaluate if the VMT rate due to the project is greater than a specified VMT threshold. In this case, the threshold is defined as 15 percent below the nine-Bay Area County home-based work VMT per employee baseline under Existing Conditions. This analysis approach does not evaluate all VMT generated by the project.

A low VMT generating project is defined as one where the home-based work VMT per employee under Existing with Project Conditions is below the VMT impact threshold. The rationale behind a low-VMT generating project is that future employees would generate new VMT, but it would have the net benefit of incrementally reducing the city's home-based work VMT rate compared to locating the project in another location (area).

Overview of Methods

As a part of this VMT analysis and mitigation process the following steps were taken to establish SB 743 VMT thresholds:

- Select a VMT calculation tool
 - Use the VTA Travel Model.
- Select the VMT accounting method(s)
 - Home-Based Work VMT per Employee: The sum of the "VMT from" and "VMT to" and within the project site/region under baseline conditions divided by the sum of the employees on the project site/region.
- Calculate the baseline city VMT estimates
 - The home-based work VMT per employee analysis presented here uses VMT from the home-based work trip purpose and light-duty vehicle types (i.e., there is no separation of VMT by land use) for the project site and the Nine-County Bay Area Region. A baseline is set as Existing Conditions home-based work VMT per employee generation rate by the nine-County



Bay Area Region (see the Project Generated VMT Estimation Method section for detailed descriptions.)

- Set a VMT threshold(s)
 - The threshold applied to home-based VMT per employee is 15 percent below the Existing Conditions for the nine-County Bay Area Region.³

Home-Based Work VMT Estimation Method

The home-based work VMT metric for the project site is calculated by summing the “VMT from” and “VMT to” the project site for light-duty vehicles. These calculations are usually performed using outputs from a travel forecasting model. Most travel forecasting models will output information on the project generated VMT associated with the land use in each transportation analysis zone (TAZ); that total is typically as follows:

$$\text{Home Based Work VMT} = (II + IX) + (II + XI) = 2 * II + IX + XI$$

- Internal-internal (II): The full length of all trips made entirely within the geographic area limits.
- Internal-external (IX): The full length of all trips with an origin within the geographic area and destination outside of the area.
- External-internal (XI): The full length of all trips with an origin outside of the geographic area and destination within the area.

The intra-zonal VMT and VMT between traffic analysis zones, or TAZs, that are in the study area causes some double counting, which is an expected result when summing the trip end based VMT. To ensure a VMT rate is expressed properly (i.e., that the numerator and denominator include the generators of both trip ends of the VMT), the home-based work VMT is divided by employees to develop a VMT rate.

VMT Threshold

Project Generated VMT Impact Thresholds and Impact Criteria

Per the *Policy Implementing the California Environmental Quality (CEQA) to Comply with California Senate Bill 743 (SB 743) Regarding the use of Vehicle Miles Traveled (VMT) in Transportation Analysis* (May 2020), the City of Mountain View used a threshold of 15 percent below the nine-County Bay Area Region home-based work VMT per employee under Existing Conditions. The Office of Planning and Research (OPR) *Technical Advisory on Evaluating Transportation Impacts in CEQA* (December 2018) suggests a similar threshold for residential and office/industrial land uses (i.e., 15 percent below VMT in a geographic area). As shown in **Table 4** the threshold applied in this assessment is 15% below the Nine-County Bay Area Region home-based work VMT per employee rate of 15.33 resulting in a home-based work VMT per

³ The City of Mountain View has selected the 15 percent reduction relative to nine-County Bay Area Region based on the OPR *Technical Advisory*, which states “...OPR recommends that a per capita or per employee VMT that is fifteen percent below that of existing development may be a reasonable threshold.” (Quote from page 10 of the *Technical Advisory on Evaluating Transportation Impacts in CEQA*, December 2018).



employee threshold of 13.03. $(15.33 \times 85\% = 13.03)$.⁴ Therefore, the project would cause a potentially significant home-based work VMT per employee impact if:

- The home-based work VMT per employee for the project is greater than 13.03.

Table 4: VMT Threshold Calculations

Item		Home-Based Work VMT per Employee
Home-Based Work VMT per Employee City Baseline Value	(A)	15.33
Home-Based Work VMT per Employee Threshold	$(A \times 85\% = B)$	13.03

Note: Rounded VMT rate to the nearest hundredth.
Source: Fehr & Peers.

VMT Estimates

Using the SCC VMT Tool, the home-based work VMT per employee rate for transportation analysis zones (TAZ) 362 for which the project is in is 15.51 (using the TAZ Method and a 2021 baseline for the project site). **Figure 9** shows the location of the project relative to these TAZs.



Figure 9: Location of TAZ 362 (TAZ boundary shown in purple and project site in blue.)

⁴ The Nine-County Bay Area Region home-based work VMT per employee rate of 15.33 extracted from the Santa Clara Valley Transportation Authority travel forecasting model provided in the SCC VMT Tool on August 2, 2021.



TAZ 362 is generally bounded by San Antonio Road to the west, California Street to the north, Rengstorff Avenue to the east, and El Camino Real to the south. As shown in **Table 5**, the project would not be in a low VMT generating area because the project is in a transportation analysis zone (TAZ) with a home-based work VMT per employee rate of 15.51 which is greater than the VMT significance threshold. Specifically, the VMT per employee would be approximately 19 percent greater than the VMT threshold for home-based work VMT per employee of 13.03. **Appendix E** presents the SCC VMT Tool report for the project.

Table 5: Home-Based Work VMT Assessment

Item	Project Site (TAZ 362)
Project Site (Using Nine-County Bay Area Region Office Baseline and TAZ Method)	
Home-Based Work VMT per Employee Threshold	13.03
Home-Based Work VMT per Employee at Project Site	15.51
Baseline VMT Screening Result	
Home-Based Work VMT per Employee Threshold (13.03)	15.51
(Baseline Screening Conclusion)	Fail

Source: Fehr & Peers, 2021.

VMT Reduction Discussion

To have a less than significant VMT impact under CEQA, the project would need to generate less than 13.03 home-based work VMT per employee. Overall, CAPCOA indicates that projects in suburban areas may be able to achieve up to a 15 percent reduction in VMT.⁵ Because the project will likely not be screened out, additional VMT analysis would be needed if the SAPP EIR were not already certified. Because CEQA encourages the use of previous environmental analysis, this CEQA analysis will rely on the VMT effects of this project disclosed in the air quality, greenhouse gas analysis and energy sections of the SAPP EIR and presents this home-based work VMT per employee baseline screening for informational purposes.

⁵ The current standard for calculating VMT reduction efficacy from TDM strategies is the California Air Pollution Control Officer Association (CAPCOA) 2010 report, *Quantifying Greenhouse Gas Mitigation Measures: A Resource for Local Government to Assess Emissions Reductions from Greenhouse Gas Mitigation Measures* (CAPCOA report). This resource evaluates the literature behind several TDM program elements and provides methods for calculating a VMT reduction associated with each.



Motor Vehicle Operations Analysis



6. Motor Vehicle Operations and Project Traffic Forecasting Methods

This chapter describes the traffic analysis methods and project trip generation estimates used for the operations analysis presented in **Chapters 8** and **9**.

Traffic Analysis Methods

The operations of roadway facilities are described with the term level of service (LOS), a qualitative description of vehicular traffic flow based on factors such as speed, travel time, delay, and freedom to maneuver. Six levels are defined from LOS A, which reflects free-flow conditions where there is very little interaction between vehicles, to LOS F, where the vehicle demand exceeds the capacity and high levels of vehicle delay result. LOS E represents “at-capacity” operations. When traffic volumes exceed the capacity at a signalized intersection, vehicles may wait through multiple signal cycles before traveling through the intersection; these operations are designated as LOS F.

Analysis Methods and Thresholds

Signalized Intersections

Analysis Method

The method described in Chapter 16 of the 2000 *Highway Capacity Manual* (HCM) (Transportation Research Board) was used to prepare the level of service calculations for the study intersections. This level of service method, which is approved by the City of Mountain View and the VTA, analyzes a signalized intersection’s operation based on average control delay per vehicle. Control delay includes the initial deceleration delay, queue move-up time, stopped delay, and final acceleration delay. The average control delay is calculated using TRAFFIX 8.0 analysis software and is correlated to a LOS designation as shown in **Table 6**.



Table 6: Signalized Intersection Level of Service Definitions

Level of Service	Description	Average Control Delay per Vehicle (seconds)
A	Operations with very low delay occurring with favorable progression and / or short cycle lengths.	≤ 10.0
B+ B B-	Operations with low delay occurring with good progression and / or short cycle lengths.	10.1 to 12.1 12.1 to 18.0 18.0 to 20.0
C+ C C-	Operations with average delays resulting from fair progression and / or longer cycle lengths. Individual cycle failures begin to appear.	20.1 to 23.0 23.1 to 32.0 32.0 to 35.0
D+ D D-	Operations with longer delays due to a combination of unfavorable progression, long cycle lengths, and high volume-to-capacity (V / C) ratios. Many vehicles stop and individual cycle failures are noticeable.	35.1 to 39.0 39.1 to 51.0 51.1 to 55.0
E+ E E-	Operations with high delay values indicating poor progression, long cycle lengths, and high V / C ratios. Individual cycle failures are frequent occurrences.	55.1 to 60.0 60.1 to 75.0 75.1 to 80.0
F	Operations with delays unacceptable to most drivers occurring due to over-saturation, poor progression, or very long cycle lengths.	> 80.0

Source: *Traffic Level of Service Analysis Guidelines*, VTA Congestion Management Program, June 2003; and *Highway Capacity Manual*, Transportation Research Board, 2000.

Signalized intersection operations and adverse effects are evaluated based on each jurisdiction’s minimum threshold for acceptable operations as shown in **Table 7** and the adverse effect thresholds identified in **Chapter 9**.

Table 7: Signalized Intersection LOS Thresholds for Acceptable Operations

Jurisdiction	Intersection LOS Standards	Citation
City of Mountain View	City of Mountain View all intersections LOS D; except for: Downtown Mountain View LOS E; San Antonio Shopping Center LOS E; CMP facilities LOS E	City of Mountain View 2030 General Plan and Greenhouse Gas Reduction Program EIR, page 121 (2011)
Santa Clara County	Santa Clara County all intersections LOS E	Santa Clara County General Plan, pages F-18 and F-19 (1994)
VTA Congestion Management Program (CMP)	VTA CMP all intersections LOS E ¹	Santa Clara County Annual Monitoring and Conformance Report, page 9 (2014)

Note:

1. San Antonio Shopping Center includes the CMP facilities of San Antonio Road between El Camino Real and California Street, and El Camino Real between San Antonio Road and Showers Drive, and local streets of California Street between San Antonio Road and Showers Drive, and Showers Drive between California Street and El Camino Real.

Source: Fehr & Peers, August 2021.



Unsignalized Intersections

The operations of the unsignalized intersections were evaluated using the method contained in Chapter 17 of the *2000 HCM*. LOS ratings for stop-sign-controlled intersections are based on the average control delay expressed in seconds per vehicle. At two-way or side-street-stop controlled intersections, control delay is calculated for each movement, not for the intersection as a whole. For approaches composed of a single lane, the control delay is computed as the average of all movements in that lane. **Table 8** summarizes the relationship between delay and LOS for unsignalized intersections.

Table 8: Unsignalized Intersection Level of Service Definitions

Level of Service	Description	Average Control Delay Per Vehicle (Seconds)
A	Little or no delay.	≤ 10.0
B	Short traffic delay.	10.1 to 15.0
C	Average traffic delays.	15.1 to 25.0
D	Long traffic delays.	25.1 to 35.0
E	Very long traffic delays.	35.1 to 50.0
F	Extreme traffic delays with intersection capacity exceeded.	> 50.0

Sources: *Highway Capacity Manual*, Transportation Research Board, 2000.

The City does not have an adopted LOS policy for unsignalized intersections; however, the City strives to maintain LOS D, which is a LOS standard that has been used in other traffic studies within the City. For side street stop-controlled intersections, the City determines the need for improvements based on turn movement operations (such as queues overflowing the storage capacity) as well as peak hour traffic signal warrant analyses from the California Manual on Uniform Traffic Control Devices (CA MUTCD).⁶

Warrant 3 – Peak hour vehicle volume

This warrant determines if the minor street traffic suffers undue delay when entering or crossing the major street for a minimum of one hour of an average day. This is based on the major street left-turn volume, the higher-volume minor-street approach volume, and calculated delay for vehicles on the higher-volume minor-street approach.

⁶ Signal warrant analysis is intended to examine the general correlation between the planned level of future development and the need to install new traffic signals. It estimates future development-generated traffic compared to a sub-set of the standard traffic signal warrants recommended in the 2014 California *Manual on Uniform Traffic Control Devices (CA MUTCD)* guidelines. While satisfying one or more of these warrants could justify the installation of a signal at an intersection, this analysis should not serve as the only basis for deciding whether and when to install a signal. To reach such a decision, the full set of warrants should be investigated by an experienced engineer based on field-measured rather than forecast traffic data and a thorough study of traffic and roadway conditions. Furthermore, the decision to install a signal should not be based solely upon the warrants, since the installation of signals may lead to certain types of collisions.



Freeway Segments

The study area includes several freeway segments. Caltrans is the owner/operator of the State highway system including freeways, interchanges, and arterial State Routes. However, as the Congestion Management Agency, VTA is responsible for monitoring operations on Caltrans facilities within Santa Clara County.

Based on VTA's *Transportation Impact Analysis Guidelines* (October 2014), freeway segments should be evaluated if any one of the following conditions are met:

- The proposed development project is expected to add traffic equal to or greater than one percent of the freeway segment's capacity
- The proposed development project is adjacent to one of the freeway segment's access or egress points
- Based on engineering judgment, Lead Agency staff determines that the freeway segment should be included in the analysis.

Based on the location of the project, the second and third criteria are not met. **Appendix D** presents the full results of the freeway screening analysis, which shows that the project will not contribute more than one percent of the freeway mixed-flow or High Occupancy Vehicle (HOV) lanes; therefore, a freeway analysis is not needed.

Project Traffic Volumes

The amount of traffic associated with the project was estimated using a three-step process:

1. **Trip Generation** – The increased *number* of vehicle that would be entering/existing the project with the increased office building size was estimated.
2. **Trip Distribution** – The *directions* that vehicles would use to approach and depart the project site are estimated based on the proximity of complementary land uses and the regional transportation network.
3. **Trip Assignment** – The number of vehicles that would be generated by the project was then assigned to specific streets and intersection turning movements based on the trip generation and trip distribution.

Each of these steps in the process are described in the following sections.

Vehicle Trip Generation Phase III

The project's net new trip generation was estimated using the baseline vehicle trip generation rates from the Institute of Transportation Engineers (ITE) *Trip Generation Manual*, 10th Edition along with additional mixed-use and transit trip reductions. The trip reductions applied were for mixed-use development with employment and employee-serving retail (3% reduction from employment component), employment located near a Caltrain station (6%), and provision of a transportation demand management program



(6.5%). These reductions are documented in Table 1 of the Santa Clara County Valley Transportation Authority (VTA) *Transportation Impact Analysis Guidelines*.

Table 9 summarizes the trip generation estimates using the ITE trip rates for the proposed project. The proposed project would generate 1,766 daily net new vehicle trips, 137 AM net new vehicle trips (117 inbound and 20 outbound), and 184 PM net new vehicle trips (40 inbound and 144 outbound). The net office trips are shown on line 'D'.

Table 9: Phase III Trip Generation Using ITE Trip Generation and VTA Trip Reductions

ITE#	Land Use Type	Method	Size	Type	Weekday Trips	AM Peak Hour Trips			PM Peak Hour Trips		
						Total	In	Out	Total	In	Out
Proposed Development											
710	Office	Fitted Curve	169.382	ksf	1,769	186	160	26	188	30	158
820	Retail	Average Rate	12.97	ksf	490	12	7	5	49	24	25
Gross Project Trips (A):					2,259	198	167	31	237	54	183
<i>Office-Retail Mixed-Use Development Reduction (3% off employment component)</i>					(53)	(6)	(5)	(1)	(6)	(1)	(5)
<i>Proximity to Caltrain Station Reduction (6% off employment component)</i>					(106)	(11)	(9)	(2)	(11)	(2)	(9)
<i>Transportation Demand Management Reduction (6.5% off employment component)</i>					(115)	(12)	(10)	(2)	(12)	(2)	(10)
Total VTA TIA Guidelines Reductions (B):					(274)	(29)	(24)	(5)	(29)	(5)	(24)
Net Project Trips (Driveway Trips) (C=A-B):					1,985	169	143	26	208	49	159
Net Office Trips (Gross Office Trips – B=D)					1,495	157	136	21	159	25	134
Existing To-Be-Demolished Development											
710	Office	Fitted Curve	5.008	ksf	58	31	27	4	7	1	6
820	Retail	Average Rate	4.386	ksf	166	4	2	2	17	8	9
Gross Existing Trips (E):					224	35	29	6	24	9	15
<i>Office-Retail Mixed-Use Development Reduction (3% off employment component)</i>					(2)	(1)	(1)	(0)	(0)	(0)	(0)
<i>Proximity to Caltrain Station Reduction (6% off employment component)</i>					(3)	(2)	(2)	(0)	(0)	(0)	(0)
Total VTA TIA Guidelines Reductions (F):					(5)	(3)	(3)	(0)	(0)	(0)	(0)
Net Existing Trips (Driveway Trips) (G=E-F):					219	32	26	6	24	9	15
Net New Project Trips (H=C-G):					1,766	137	117	20	184	40	144



Notes:

1. ITE Trip Generation Manual (10th Edition) provides an average rate and a best fit curve equation for trip generation estimates. The following fitted curve equations were used for ITE Land Use 710: General Office Building:

Daily: $\ln(T) = 0.97 * \ln(X) + 2.50$

AM Peak Hour: $T = 0.94(X) + 26.49$ (86% in, 14% out)

PM Peak Hour: $\ln(T) = 0.95 * \ln(X) + 0.36$ (16% in, 84% out)

where T is the number of trips generated and X is the development size in 1,000 square feet

2. ITE Trip Generation Manual (10th Edition) provides an average rate and a best fit curve equation for trip generation estimates. The following average rates were used for ITE Land Use 820: Shopping Center:

Daily: $T = 37.75(X)$

AM Peak Hour: $T = 0.94(X)$ (62% in, 38% out)

PM Peak Hour: $T = 3.81(X)$ (48% in, 52% out)

where T is the number of trips generated and X is the development size in 1,000 square feet

Source: ITE *Trip Generation Manual* (10th Edition); Fehr & Peers, 2021.

Project Trip Targets – Phase II & Phase III

The project’s Conditions of Approval require that the project reduce peak-hour vehicle trips made by employees by 30 percent through Transportation Demand Management measures, starting from a baseline established in the ITE *Trip Generation Manual*, 9th Edition for general office building land use (ITE land use code 710). Consistent with other phases of the San Antonio Village, **Table 10** shows the vehicle trip targets calculated using the ITE 9th Edition general office vehicle trip rates and a 30 percent TDM reduction.

Table 10: Phase II + Phase III Trip Targets – ITE 9th Edition with a 30% TDM Reduction

Land Use	Size	Type	AM Peak Hour Trips			PM Peak Hour Trips		
			Total	In	Out	Total	In	Out
As-Built Phase II Office ¹	360.090	ksf	533	469	64	482	82	400
Proposed Phase III Office	169.382	ksf	292	257	35	268	46	222
Gross Office Trips:			825	726	99	750	128	622
<i>Transportation Demand Management Reduction (30%):</i>			<i>(248)</i>	<i>(218)</i>	<i>(30)</i>	<i>(225)</i>	<i>(38)</i>	<i>(187)</i>
9th Edition w/ 30% TDM - Phase II + Phase III Trip Target:			577	508	69	525	90	435

Notes:

1. As-Built Phase II Office square footage as provided by Merlone Geier.
2. ITE Trip Generation Manual (9th Edition) provides an average rate and a best fit curve equation for trip generation estimates. The following fitted curve equations were used for ITE Land Use 710: General Office Building:

Daily: $\ln(T) = 0.76 * \ln(X) + 3.68$

AM Peak Hour: $\ln(T) = 0.80 * \ln(X) + 1.57$ (88% in, 12% out)

PM Peak Hour: $T = 1.12 * (X) + 78.45$ (17% in, 83% out)

where T is the number of trips generated and X is the development size in 1,000 square feet

Source: ITE *Trip Generation Manual* (9th Edition); Fehr & Peers, 2021.



Since the baseline using the 9th Edition was established, ITE has released the 10th Edition of the *Trip Generation Manual* (the edition used to calculate the project’s net new trip generation above). The updated *Trip Generation Manual* removed outdated data and included new more recent data for office uses. As a result, the average and fitted curves rates for the general office building land use presented in *Trip Generation Manual*, 10th Edition yield trip generation estimates that are approximately 30 percent lower than those presented in *Trip Generation Manual*, 9th Edition.

Table 11 shows the Phase II and III trip targets calculated by applying a 30 percent TDM reduction to the 10th Edition office trip rates. **Table 11** also compares this new trip target calculation to the results from the 9th Edition office trip rates in **Table 10**. The results show that applying a 30 percent TDM reduction to the 10th Edition office trip rates results in an additional 20 to 35 percent reduction in the office trip targets from the 9th Edition office rates with a 30% TDM reduction.

Table 11: Phase II + Phase III Trip Targets – 10th Edition with a 30% TDM Reduction

Land Use	Size	Type	AM Peak Hour Trips			PM Peak Hour Trips		
			Total	In	Out	Total	In	Out
As-Built Phase II Office ¹	360.090	ksf	365	314	51	385	62	323
Proposed Phase III Office	169.382	ksf	186	160	26	188	30	158
Gross Office Trips:			551	474	77	573	92	481
<i>Transportation Demand Management Reduction (30%):</i>			<i>(165)</i>	<i>(142)</i>	<i>(23)</i>	<i>(172)</i>	<i>(28)</i>	<i>(144)</i>
10th Edition w/ 30% TDM - Phase II + Phase III Trip Target:			386	332	54	401	64	337
Difference From ITE 9th Edition Trip Target (Table 10)²:			-191	-176	-15	-124	-26	-98
Percent Difference³:			-33%	-35%	-22%	-24%	-29%	-23%

Notes:

- As-Built Phase II Office square footage as provided by Merlone Geier.
- Difference is shown as the Phase II + Phase III Trip Targets calculated using the 9th Edition equations calculated in **Table 10** subtracted from the Phase II + Phase III Trip Targets calculated in this table.
- Percent difference is the additional reduction from the 9th Edition office trip rates with a 30 percent TDM reduction and the 10th Edition office trip rates with a 30 percent TDM reduction.
- ITE Trip Generation Manual (10th Edition) provides an average rate and a best fit curve equation for trip generation estimates. The following fitted curve equations were used for ITE Land Use 710: General Office Building:
 Daily: $\ln(T) = 0.97 * \ln(X) + 2.50$
 AM Peak Hour: $T = 0.94(X) + 26.49$ (86% in, 14% out)
 PM Peak Hour: $\ln(T) = 0.95 * \ln(X) + 0.36$ (16% in, 84% out)
 where T is the number of trips generated and X is the development size in 1,000 square feet

Source: ITE *Trip Generation Manual* (10th Edition); Fehr & Peers, 2021.

Based on discussions with City staff, the baseline has been revised to incorporate data presented in the ITE *Trip Generation Manual*, 10th Edition for general office building land use (ITE land use code 710). Since the 10th Edition are lower than the 9th Edition rates, the project’s trip target has been revised from a 30 percent reduction through TDM to a 6.5 percent TDM reduction consistent VTA’s *TIA Guidelines*.



San Antonio Center Phase II and Phase III share common access points and parking; therefore, the trip target for both phases are calculated together. **Table 12** presents the estimated trip generation for Phase II and Phase III of San Antonio Center that will be used as the trip target for future TDM monitoring. Phase II and Phase III must generate fewer than 515 AM net new vehicle trips, and 536 PM net new vehicle trips. The project’s TDM plan establishes monitoring methods to ensure that the project meets this threshold.

Table 12: Phase II + Phase III Trip Targets – 10th Edition with 6.5% VTA TDM Reduction

Land Use	Size	Type	AM Peak Hour Trips			PM Peak Hour Trips		
			Total	In	Out	Total	In	Out
As-Built Phase II Office ¹	360.090	ksf	365	314	51	385	62	323
Proposed Phase III Office	169.382	ksf	186	160	26	188	30	158
Gross Office Trips:			551	474	77	573	92	481
<i>Transportation Demand Management Reduction (6.5%):</i>			<i>(36)</i>	<i>(31)</i>	<i>(5)</i>	<i>(37)</i>	<i>(6)</i>	<i>(31)</i>
10th Edition w/ 6.5% TDM - Phase II + Phase III Trip Target:			515	443	72	536	86	450

Notes:

- As-Built Phase II Office square footage as provided by Merlone Geier.
- ITE Trip Generation Manual* (10th Edition) provides an average rate and a best fit curve equation for trip generation estimates. The following fitted curve equations were used for ITE Land Use 710: General Office Building:
 Daily: $\ln(T) = 0.97 * \ln(X) + 2.50$
 AM Peak Hour: $T = 0.94(X) + 26.49$ (86% in, 14% out)
 PM Peak Hour: $\ln(T) = 0.95 * \ln(X) + 0.36$ (16% in, 84% out)
 where T is the number of trips generated and X is the development size in 1,000 square feet

Source: *ITE Trip Generation Manual* (10th Edition); Fehr & Peers, 2021.

To assist the City with the selection of the project trip target, **Table 13** compares the three Phase II and III trip target options discussed above against the 9th Edition office trip rates. The 9th Edition office trip rates with a 30% TDM reduction (trip targets in **Table 10**) are similar to the 10th Edition office trip rates with a 6.5% TDM reduction (trip targets in **Table 12**). The 10th Edition office trip rates with 30% TDM reduction is over 45 to 54 percent less than the 9th Edition office trip rates, which is approximately double the original 30% TDM reduction goal.

Table 13: San Antonio Village Phase II + Phase III – Trip Target Comparison

Rate Assumptions	Applied TDM Reduction	Reduction over ITE 9 th Edition	AM Peak Hour Trips			PM Peak Hour Trips		
			Total	In	Out	Total	In	Out
ITE 9 th Edition	0%	0%	825	726	99	750	128	622
ITE 9 th Edition w/ 30%	30%	30%	577	508	69	525	90	435
ITE 10 th Edition w/ 30%	30%	45 – 54%	386	332	54	401	64	337
ITE 10 th Edition w/ VTA	6.5%	27 – 39%	515	443	72	536	86	450

Source: Fehr & Peers, 2021.



Vehicle Trip Distribution

The directions of approach and departure of project trips were based on the locations of complementary land uses as well as existing and future travel patterns in the area. **Table 14** shows the distribution of project traffic along the roadway network. **Figure 10** shows the trip distribution for each relevant segment in the roadway network.

Table 14: Trip Distribution

Destination	Trip Distribution (%)
US 101 south of Rengstorff Avenue	20
US 101 north of San Antonio Road	15
El Camino Real west of Arastradero Road-Charleston Road	15
El Camino Real east of Rengstorff Avenue	12
Alma Street west of San Antonio Road	10
Central Expressway east of Rengstorff Avenue	10
Middlefield Road west of Charleston Road	5
Middlefield Road east of Rengstorff Avenue	5
San Antonio Road south of El Camino Real	5
Arastradero Road south of El Camino Real	3
Total	100

Source: Fehr & Peers, 2021.

Vehicle Trip Assignment

The project trips were assigned to the roadway system based on the directions of approach and departure discussed above. **Figure 11** shows the project trips assigned to each turning movement by intersection. The corresponding project trip assignment was added to the existing volumes to represent Existing with Project Conditions and Background with Project Conditions. Volumes for Existing with Project Conditions and Background with Project Conditions are presented in **Figure 12** and **Figure 14**, respectively.



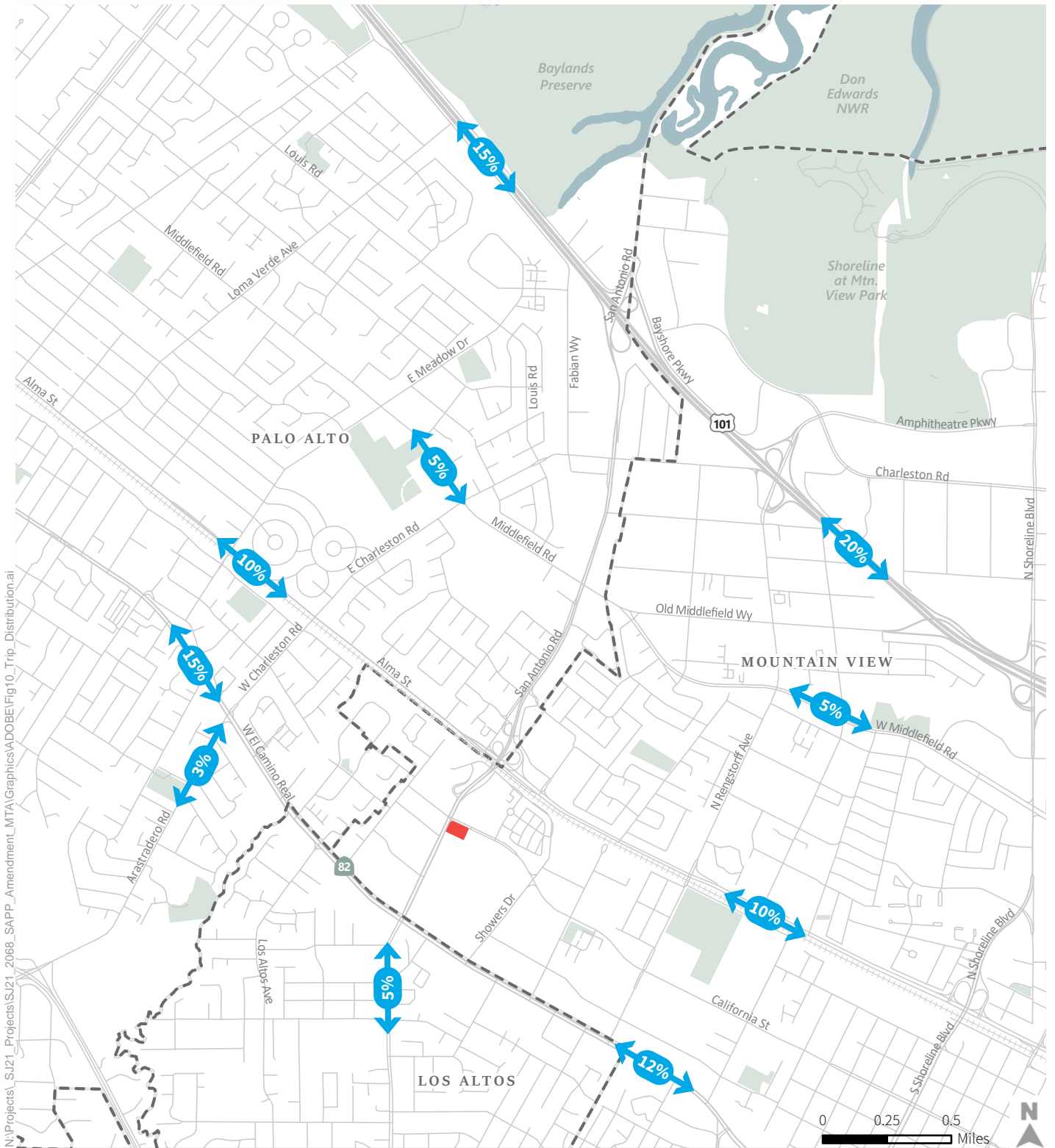

N:\Projects\SJ21_Projects\SJ21_2068_SAPP_Amendment_MTA\Graphics\ADOBE\Fig10_Trip_Distribution.ai

- Project Site
- ↔ Trip Distribution
- City Boundaries



Figure 10
Trip Distribution

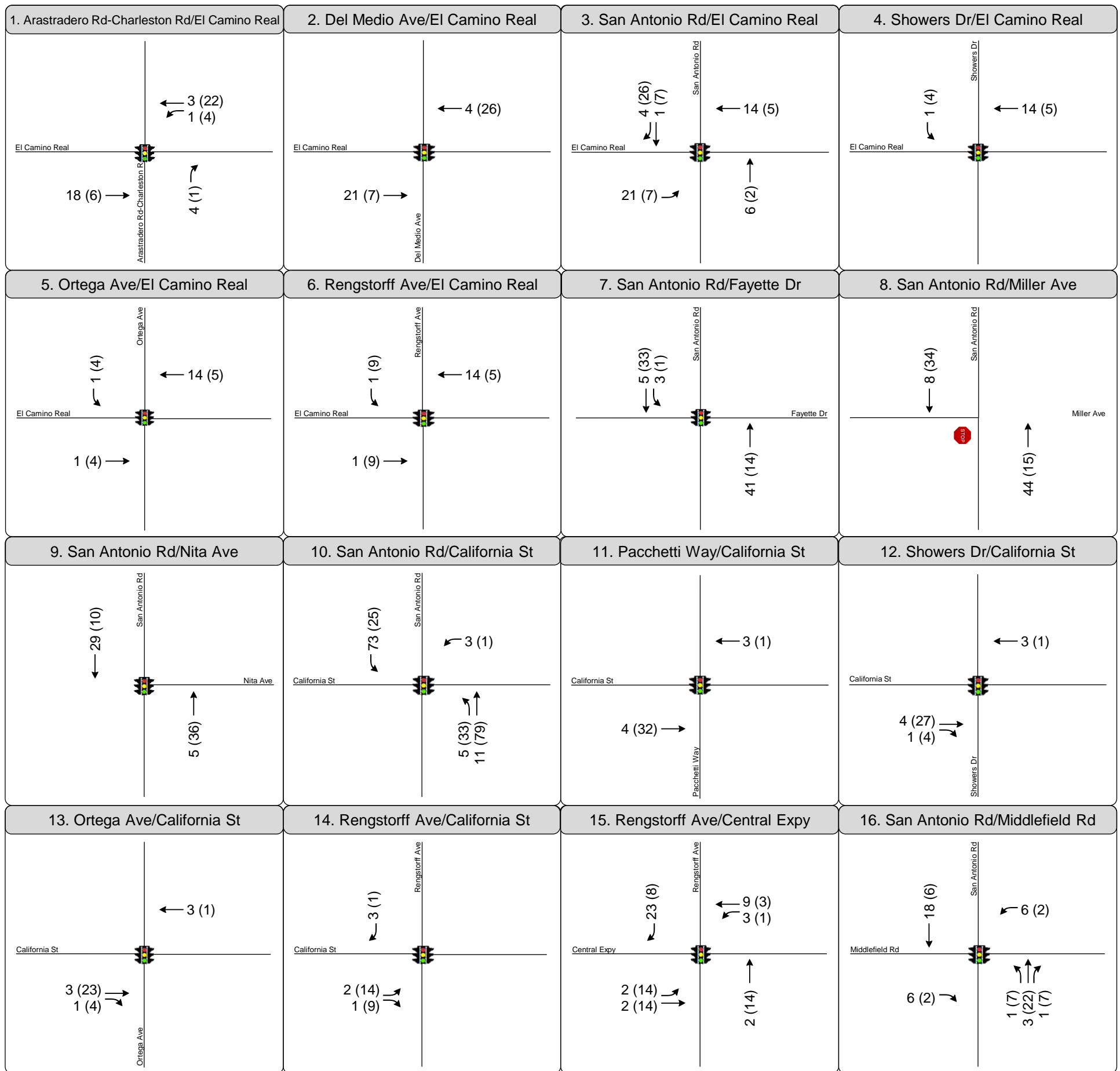

Figure 11
Project Trip Assignment

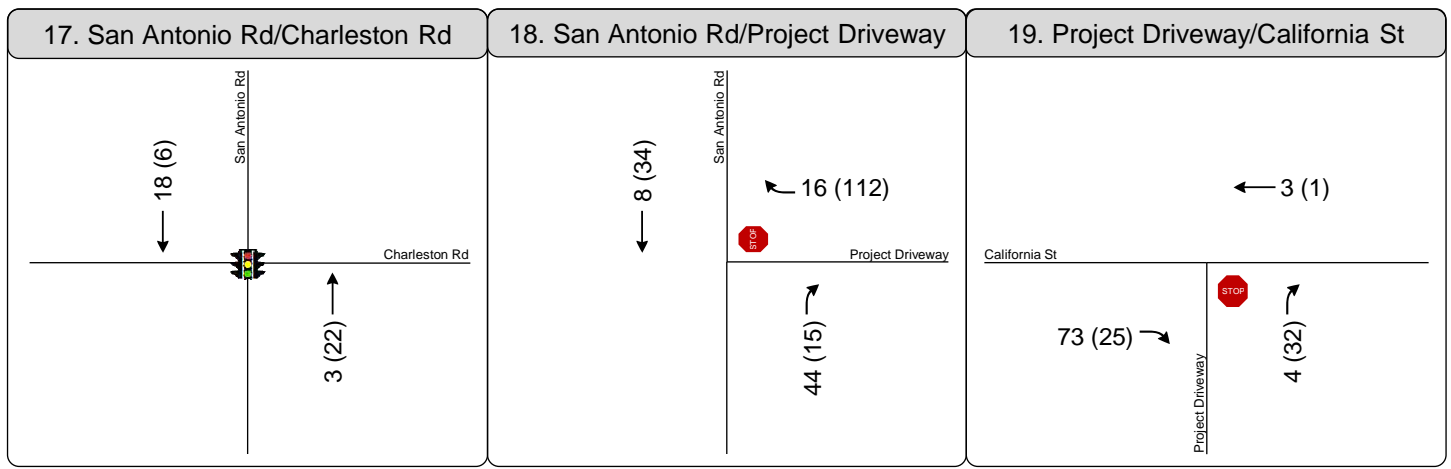

Figure 11
Project Trip Assignment

7. SAPP Consistency Evaluation

The 2014 SAPP EIR Transportation and Circulation section describes the existing transportation services and facilities on or near the project site, including the roadway system (including signalized intersections, unsignalized intersections, and freeway segments), bus and rail service, bicycle facilities, and pedestrian facilities. The EIR presents the results of the evaluation of the Precise Plan's effect on those facilities and services for two scenarios: Existing (2013) plus Project Conditions and Cumulative (2030) plus Project Conditions.

The transportation analysis that was prepared for the Precise Plan followed the guidelines of the City of Mountain View (City) and the Santa Clara Valley Transportation Authority (VTA), which acts as the Congestion Management Agency (CMA) for Santa Clara County (County). Potential transportation impacts were evaluated using the standards, methods, and significance criteria of these agencies. Mitigation measures for identified significant impacts were identified where such measures were available and feasible. Since the San Antonio Precise Plan EIR was certified in 2014, pre-SB 743, the transportation impacts evaluation at that time included level of service (LOS) and not vehicle miles traveled (VMT), as was required starting in 2020. The 2014 SAPP EIR included the San Antonio Village project.

Consistency Evaluation

To determine consistency with the SAPP EIR, a trip generation analysis and baseline data comparison was conducted as described below.

- **Trip Generation Comparison:** To show that the project is within the total number of trips studied in the SAPP EIR, the trip generation for all constructed San Antonio Village II development plus the net new Phase II project trips were compared to the total trip generation estimates used in the *San Antonio Precise Plan Traffic Impact Analysis (2014)*. This trip generation comparison is used to determine if the off-site transportation improvements required in the SAPP EIR Mitigation Monitoring Report Program are still applicable.
- **Baseline Conditions Comparison:** To show that this project's baseline conditions (reflecting traffic patterns in October and November 2019) are within the range of forecasted conditions studied in the SAPP EIR, traffic volumes under Existing Conditions were compared to volumes for the EIR's baseline conditions (i.e., Existing Conditions) and forecasted scenarios (i.e., Cumulative Conditions). This volume comparison is used to determine if additional transportation analysis is needed because of any changes in background traffic conditions.

Trip Generation Comparison to San Antonio Precise Plan

The 2014 San Antonio Precise Plan TIA evaluated the effect of adding 2,026 net new AM peak hour vehicle trips and 3,643 net new PM peak hour vehicle trips. Additionally, the approved projects and constructed projects within the San Antonio Precise Plan area generate a total of 1,334 AM peak hour vehicle trips and



1,968 PM peak hour vehicle trips. (A summary of the projects considered and trip generation by project is presented in **Appendix E.**) **Table 15** below presents the sum of the trip generation estimates for the approved projects and constructed projects within the San Antonio Precise Plan area, the proposed project (San Antonio Center Phase III) trip generation estimates, and the difference between those trips and the net new trips studied under the 2014 San Antonio Precise Plan TIA. Altogether, the approved and constructed projects plus the proposed project (San Antonio Center Phase III) would generate 555 fewer AM peak hour trips and 1,491 fewer PM peak hour trips than the trip generation evaluated in the San Antonio Precise Plan TIA.

Therefore, the traffic-related impacts for SAPP development as construction (including the proposed project) would be less than those identified in the 2014 San Antonio Village TIA and the SAPP EIR.

Table 15: San Antonio Precise Plan Trip Generation Comparison

Trip Generation Estimates	AM Peak Hour Trips			PM Peak Hour Trips		
	Total	In	Out	Total	In	Out
San Antonio Precise Plan Trips Studied ¹ (A):	2,026	1,232	794	3,643	1,621	2,022
Net New Project Trip Generation (San Antonio Village Phase III) ² (B):	137	117	20	184	40	144
Background Trip Generation (Approved & Constructed Projects in the San Antonio Precise Plan Area) ³ (C):	1,334	495	839	1,968	1,073	895
Net Difference (D=A-B-C):	555	620	-65	1,491	508	983

Note:

1. From the *San Antonio Precise Plan Traffic Impact Analysis* (2014).
2. From **Table 9**: Phase III Trip Generation Using ITE Trip Generation and VTA Trip Reductions of this report.
3. From the Mountain View Active Projects Lists between 2014 and 2021. A full list of projects included in this estimate is presented in **Appendix E**.

Source: City of Mountain View.

Baseline Condition Comparison

The AM and PM peak hour volumes used for Existing Conditions analysis in this report were compared to the baseline volumes and Cumulative forecasts (2030 volumes) from the 2014 San Antonio Village TIA to determine if the more recent counts (representing traffic patterns in October and November 2019) are consistent with the vehicle volumes studied in the EIR. This count comparison was conducted at the following intersections near or adjacent to the project site:

- El Camino Real and Arastradero Road-Charleston Road
- El Camino Real and Del Medio Avenue
- El Camino Real and San Antonio Road
- El Camino Real and Showers Drive
- El Camino Real and Ortega Avenue
- El Camino Real and Rengstorff Avenue



- California Street and San Antonio Road
- California Street and Pacchetti Way
- California Street and Showers Drive
- California Street and Ortega Avenue
- California Street and Rengstorff Avenue
- Central Expressway and Rengstorff Avenue
- Middlefield Road and San Antonio Road
- Charleston Road and San Antonio Road

The counts were compared on a turn-by-turn and total intersection basis (see **Appendix E**). The turn-by-turn comparison shows some variation; however, the turning movements that exhibit the greatest percentage variation are movements with low numbers of vehicles and the differences in terms of numbers of vehicles are nominal. The more aggregated comparisons at the intersection level shows that the Cumulative (2030) volumes used in the EIR are on average higher than the recent counts. Therefore, the updated information about background traffic conditions does not affect the current utility of the analysis or the significance determinations in the EIR. The traffic analysis in the EIR remains adequate, and no additional analysis is needed.

Conclusion

Based on an examination of the analysis, findings, and conclusions of the SAPP EIR, implementation of the project as proposed would not substantially increase the severity of significant impacts identified in the SAPP EIR, nor would it result in new significant impacts related to traffic that were not identified in the SAPP EIR. Mitigation measures TRANS-1, AIR-1, NOISE-1, UTL-1, UTL-2, and UTL-3 would be applicable to and would be implemented by Phase III as necessary. These mitigation measures would ensure that impacts related to traffic would be equal to, or less severe than, those previously identified and disclosed in the EIR. These measures are included below for reference:

- TRANS-1: *Add a right turn overlap phase at Intersection #17, San Antonio Road/California Avenue for the westbound right turn movement, or comparable improvement to maintain acceptable intersection LOS.*
- AIR-1: *All new development projects, associated with implementation of the SA Precise Plan, which include buildings within 1,000 feet of a residential dwelling unit shall conduct a construction health risk assessment to assess emissions from all construction equipment during each phase of construction prior to issuance of building permits. Equipment usage shall be modified as necessary to ensure that equipment use would not result in a carcinogenic health risk of more than 10 in 1 million, an increased non-cancer risk of greater than 1.0 on the hazard index (chronic or acute), or an annual average ambient PM_{2.5} increase greater than 0.3 µg/m³.*
- NOISE-1: *The following language shall be included as a Condition of Approval for new project associated with implementation of the SA Precise Plan:*



- *In the event that pile driving would be required for any proposed project within the SA Precise Plan area, all residents within 300 feet of the project site shall be notified of the schedule for its use a minimum of one week prior to its commencement. The contractor shall implement "quiet" pile driving technology (such as pre-drilling of piles, the use of more than one pile driver to shorten the total pile driving duration, or the use of portable acoustical barriers) where feasible, in consideration of geotechnical and structural requirements and conditions.*
- *To the extent feasible, the project contractor shall phase high-vibration generating construction activities, such as pile-driving/ground-impacting operations, so they do not occur in the same period with demolition and excavation activities in locations where the combined vibrations would potentially impact sensitive areas.*
- *The project contractor shall select demolition methods not involving impact, where possible (for example, milling generates lower vibration levels than excavation using clam shell or chisel drops).*
- *The project contractor shall avoid using vibratory rollers and packers near sensitive areas wherever possible.*
- *UTL-1: As private properties within the Plan area are developed, project-specific capacity and condition analyses of applicable water infrastructure adjacent and downstream of the project sites shall be performed to identify any impacts to the water system. As a condition of approval and prior to issuance of grading and/or building permits, the Public Works Department will determine and assign responsibility to project applicants for upgrades and improvements to the City's water infrastructure, as necessary.*
- *UTL-2: As private properties within the Plan area are developed, project-specific capacity and condition analyses of applicable wastewater infrastructure adjacent and downstream of the project sites shall be performed to identify any impacts to the wastewater system. As a condition of approval and prior to issuance of grading and/or building permits, the Public Works Department will determine and assign responsibility to project applicants for upgrades and improvements to the City's wastewater infrastructure, as necessary.*
- *UTL-3: As private properties within the Plan area are developed, project-specific analyses o stormwater infrastructure adjacent and downstream of the project sites shall be performed to identify any impacts to the system. As a condition of approval and prior to issuance of grading and/or building permits, the Public Works Department will determine and assign responsibility to project applicants for upgrades and improvements to the City's stormwater infrastructure, as necessary.*



8. Existing with Project Conditions

This chapter presents the effects of the proposed project on the surrounding roadway system under Existing with Project Conditions. Existing with Project Conditions are defined as Existing Conditions plus net-new traffic generated by the proposed project. Project effects on intersection and freeway segments under this scenario are identified by comparing the level of service results under Existing with Project Conditions to those under Existing Conditions.

Existing with Project Intersection Analysis

Level of service calculations were prepared using the TRAFFIX 8.0 software to evaluate signalized intersection operations under Existing with Project Conditions. The intersection volumes including the existing volumes on **Figure 7** are shown on **Figure 12** and results of the LOS analysis are summarized in **Table 16**. The corresponding LOS calculation sheets are included in **Appendix C**.

The results for Existing Conditions are included in **Table 16** for comparison purposes, along with the projected increases in critical delay and critical volume-to-capacity (V/C) ratios between the Existing without and with Project Conditions. Critical delay represents the delay associated with the critical movements of the intersection, or the movements that require the most “green time” and have the greatest effect on overall intersection operations. At some intersections, the critical delay is higher than the average delay. This generally occurs when the minor approaches contribute higher delay than the major approaches. Additionally, some intersections operate with less delay under Existing with Project Conditions compared to Existing Conditions. This can occur when the project adds traffic to underutilized movements, thereby increasing the proportion of intersection trips with lower-than-average delay.

The results of the LOS calculations indicate all the study area intersections will operate at acceptable levels of service under Existing with Project Conditions.



Table 16: Existing and Existing with Project Intersection Levels of Service

Intersection	LOS Threshold ¹	Peak Hour ²	Existing Conditions ³		Existing with Project Conditions			
			Delay ⁴	LOS ⁵	Delay ⁴	LOS ⁵	Δ in Crit. V/C ⁶	Δ in Crit. Delay ⁷
1 El Camino Real and Arastradero Road-Charleston Road (PA)*	LOS E	AM PM	33.8 40.9	C- D	33.8 40.9	C- D	0.001 0.005	0.0 0.1
2 El Camino Real and Del Medio Avenue (MV)	LOS D	AM PM	20.2 13.2	C+ B	20.2 13.1	C+ B	0.001 0.001	0.0 0.0
3 El Camino Real and San Antonio Road (MV)* **	LOS E	AM PM	33.1 51.6	C- D-	33.3 51.6	C- D-	0.012 0.001	0.4 0.0
4 El Camino Real and Showers Drive (MV)**	LOS E	AM PM	23.1 26.8	C C	23.1 26.9	C C	0.003 0.002	-0.1 0.1
5 El Camino Real and Ortega Avenue (MV)	LOS D	AM PM	15.9 12.4	B B	15.9 12.6	B B	0.003 0.003	0.0 0.2
6 El Camino Real and Rengstorff Avenue (MV)*	LOS E	AM PM	17.2 29.4	B C	17.2 29.7	B C	0.003 0.004	0.0 0.3
7 Fayette Drive and San Antonio Road (MV)**	LOS E	AM PM	15.6 19.9	B B-	15.5 20.6	B C+	0.001 0.036	0.0 4.4
8 Miller Avenue and San Antonio Road ⁵ (MV)**	LOS E	AM PM	11.6 11.5	B B	11.7 11.6	B B	N/A ⁸	N/A ⁸
9 Nita Avenue and San Antonio Road (PA)	LOS D	AM PM	8.7 4.8	A A	8.7 4.8	A A	0.001 0.010	0.0 0.0
10 California Street and San Antonio Road (MV)**	LOS E	AM PM	31.2 57.7	C E+	31.9 60.8	C E	0.003 0.025	0.1 6.0
11 California Street and Pacchetti Way (MV)**	LOS E	AM PM	25.2 24.5	C C	25.0 24.3	C C	0.002 0.019	-0.1 0.0
12 California Street and Showers Drive (MV)**	LOS E	AM PM	31.1 31.8	C C	31.1 31.7	C C	0.002 0.010	0.0 -0.2
13 California Street and Ortega Avenue (MV)	LOS D	AM PM	26.1 19.5	C B-	26.1 19.2	C B-	0.001 0.008	-0.1 -0.3
14 California Street and Rengstorff Avenue (MV)	LOS D	AM PM	31.2 34.2	C C-	31.2 34.4	C C-	0.002 0.009	0.1 0.3
15 Central Expressway and Rengstorff Avenue (SCC)	LOS E	AM PM	29.8 67.2	C E	30.0 69.6	C E	0.005 0.012	0.1 4.8
16 Middlefield Road and San Antonio Road (PA)*	LOS E	AM PM	51.4 55.0	D- E+	53.3 56.5	D- E+	0.009 0.011	2.7 2.7
17 Charleston Road and San Antonio Road (PA)*	LOS E	AM PM	34.0 48.1	C- D	34.0 48.9	C- D	0.000 0.007	0.0 1.4
18 Project Driveway and San Antonio Road (MV)**	LOS E	AM PM	10.6 11.9	B B	10.9 13.9	B B	N/A ⁸	N/A ⁸
19 Project Driveway and California Street (MV)**	LOS E	AM PM	9.7 11.6	A B	10.0 12.2	B B	N/A ⁸	N/A ⁸



Notes:

Bold text indicates intersection operates at unacceptable level of service. **Bold and highlighted text** indicates an adverse effect. PA = Palo Alto; MV = Mountain View; SCC = Santa Clara County; * = Congestion Management Program Intersection; and ** = San Antonio Center Planning Area Intersection.

1. LOS Threshold is the threshold between acceptable and unacceptable level of service.
2. AM = morning peak hour, PM = evening peak hour.
3. Existing Conditions presents the delay and LOS for intersections using existing intersection geometry and existing traffic counts.
4. Whole intersection weighted average control delay expressed in seconds per vehicle calculated using methods described in the 2000 *Highway Capacity Manual*, with adjusted saturation flow rates to reflect Santa Clara County Conditions for signalized intersections. For side-street stop-controlled intersections total delay for the worst approach is reported.
5. LOS = Level of Service. LOS calculations conducted using the TRAFFIX 8.0 analysis software packages, which applies the methods described in the 2000 *Highway Capacity Manual*.
6. Change in critical volume to capacity ratio between Existing Conditions and Existing with Project Conditions.
7. Change in average critical movement delay between Existing Conditions and Existing with Project Conditions.
8. Change in critical v/c and change in critical delay are not applicable for an unsignalized intersection (#8) or the right-in-right-out driveways (#18 and #19).

Source: Fehr & Peers, 2021.

Signal Warrant Analysis

There are three intersections that were considered to side street stop sign controlled locations. If an unsignalized intersection operates at an unacceptable level of service, a signal warrant analysis is required to determine if the location should be signalized. However, peak hour traffic signal warrant analyses were not required at Intersection #8 (Miller Avenue and San Antonio Road) because this stop-sign controlled intersections operate acceptably, nor at study intersection #18 (Project Driveway and San Antonio Road) or study intersection #19 (Project Driveway and California Street) are right-in-right-out driveways.



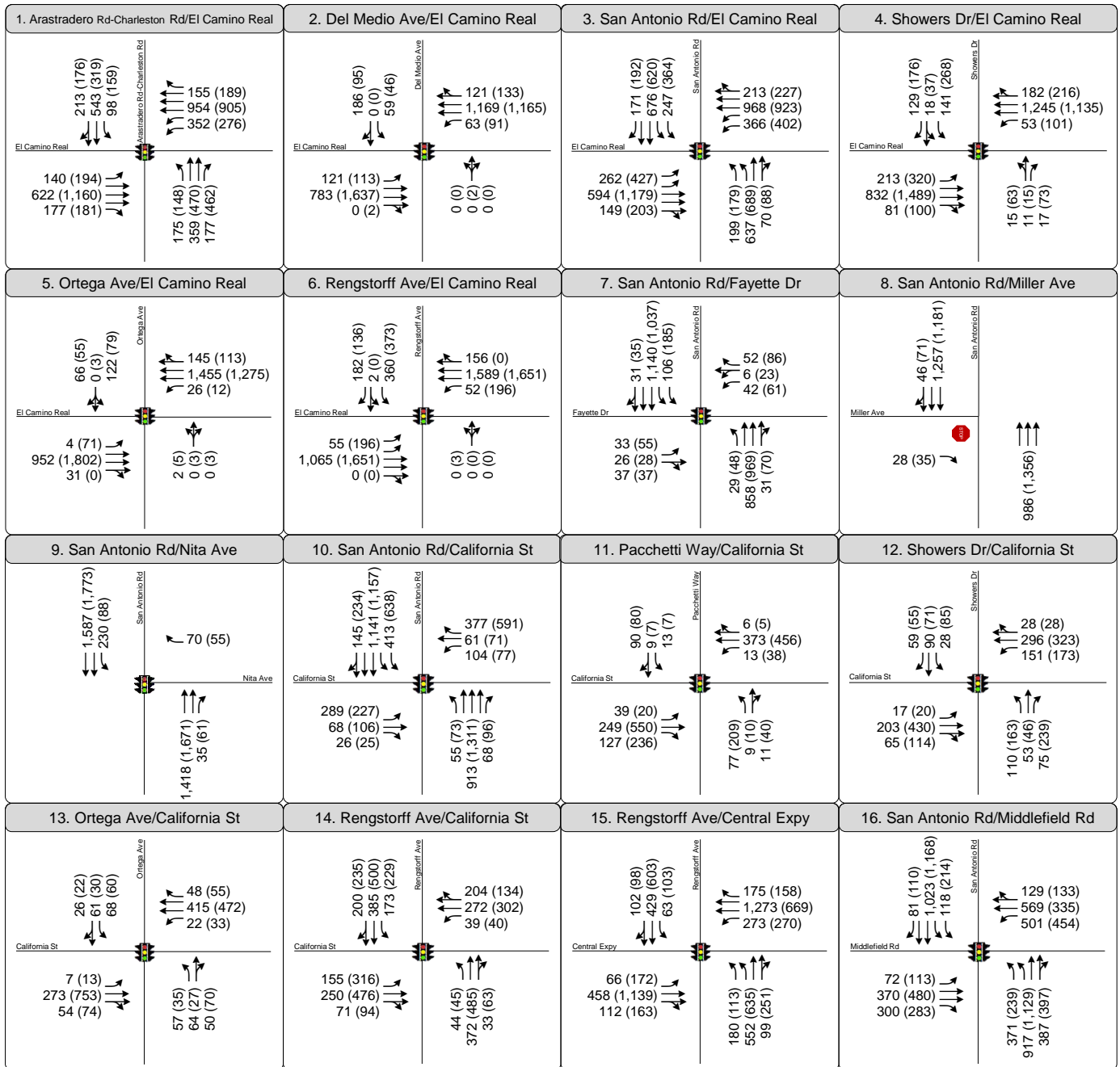

Figure 12

Peak Hour Traffic Volumes
and Lane Configurations -
Existing Plus Project Conditions



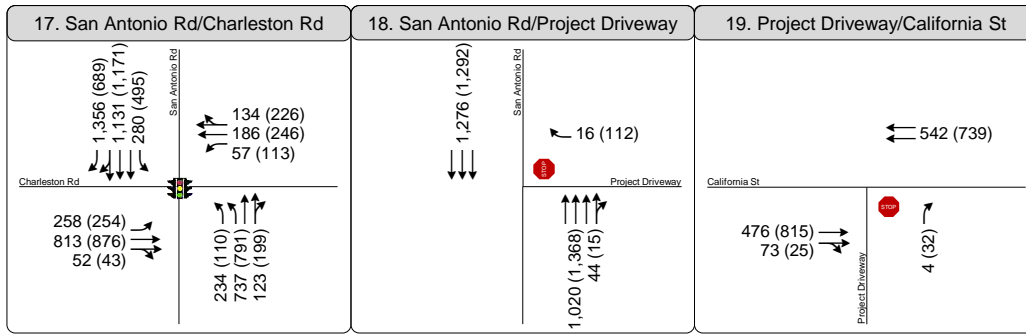

Figure 12

Peak Hour Traffic Volumes
and Lane Configurations -
Existing Plus Project Conditions



Existing with Project Freeway Segment Analysis

Table 17: AM and PM Freeway LOS presents the results of the freeway screening analysis. In addition to presenting the capacity and LOS of each freeway segment within the project area, this analysis shows that the project is not expected to increase the traffic demand on any freeway segment by one percent or more, screening out any further freeway analysis.



Table 17: AM and PM Freeway LOS

Facility	Direction	From	To	Number of Lanes			LOS		Capacity		Project Trips ¹	
				Total	Mixed	HOV	Mixed	HOV	Mixed	HOV	Mixed	HOV
2018 Freeway LOS AM												
US 101	SB	Oregon Expy	San Antonio Rd	5	3	2	D	A	6,900	3,300	18	3
US 101	SB	San Antonio Rd	Rengstorff Ave	5	3	2	E	A	6,900	3,300	2	0
US 101	SB	Rengstorff Ave	Shoreline Blvd	5	3	2	D	C	6,900	3,300	3	1
US 101	SB	Shoreline Blvd	SR 85	4	3	1	E	A	6,900	1,650	3	1
US 101	NB	SR 85	Shoreline Blvd	6	4	2	F	E	9,200	3,300	24	4
US 101	NB	Shoreline Blvd	Rengstorff Ave	6	4	2	F	D	9,200	3,300	24	4
US 101	NB	Rengstorff Ave	San Antonio Rd	5	3	2	E	D	6,900	3,300	12	2
US 101	NB	San Antonio Rd	Oregon Expy	5	3	2	F	E	6,900	3,300	3	0
2018 Freeway LOS PM												
US 101	SB	Oregon Expy	San Antonio Rd	5	3	2	F	D	6,900	3,300	5	1
US 101	SB	San Antonio Rd	Rengstorff Ave	5	3	2	F	D	6,900	3,300	12	2
US 101	SB	Rengstorff Ave	Shoreline Blvd	5	3	2	F	D	6,900	3,300	24	4
US 101	SB	Shoreline Blvd	SR 85	4	3	1	F	E	6,900	1,650	24	4
US 101	NB	SR 85	Shoreline Blvd	6	4	2	F	D	9,200	3,300	7	1
US 101	NB	Shoreline Blvd	Rengstorff Ave	6	4	2	F	D	9,200	3,300	7	1
US 101	NB	Rengstorff Ave	San Antonio Rd	5	3	2	F	D	6,900	3,300	3	1
US 101	NB	San Antonio Rd	Oregon Expy	5	3	2	F	F	6,900	3,300	18	3

Notes:

1. All project trips reported for these freeway segments do not add more than 1% of traffic demand to that segment.

Sources: VTA CMP Data, 2018; Fehr and Peers, 2021.



9. Background and Background with Project Conditions

This chapter presents the transportation analysis under Background Conditions and Background with Project Conditions. Background Conditions are defined as conditions prior to completion and occupancy of the project. Traffic volumes for Background Conditions are based on existing volumes and approved but not yet constructed and/or occupied developments in the area. Background with Project Conditions are defined as Background Conditions plus the net-added project traffic.

Background Conditions Roadway Infrastructure Improvements

There are no planned transportation improvements within the study area that would affect the geometries at the study intersections; therefore, the intersection geometries are assumed to be the same as presented in Existing Conditions.

Background Conditions Traffic Volumes

Information about these development projects was obtained from the planning departments of the City of Mountain View, City of Palo Alto, and City of Los Altos. Based on that information, the following development projects have been included in this Background scenario and their trip generation is presented in **Appendix F**:

City of Mountain View Background Development Projects (as of June 2021)

- 2300 West El Camino Real (153 room hotel)
- 1958 Latham Street (6 rowhouse units)
- 2700 West El Camino Real (211 apartment units and 2,000 sq. ft. commercial)
- 250 San Antonio Circle (3,350 sq. ft. community classroom)
- 2580 and 2590 California Street/201 San Antonio Circle (632 residential units and 20,000 sq. ft. commercial)
- 315 and 319 Sierra Vista Avenue (15 rowhouse units)
- 1998-2024 Montecito Avenue (17 condominium units)
- 1950 Montecito Avenue (33 rowhouse units)
- 2044 and 2054 Montecito Avenue (52 rowhouse units)
- 410-414 Sierra Vista Avenue (14 rowhouse units)
- 2005 Rock Street (55 rowhouse units)
- 2310 Rock Street (55 rowhouse units)
- 1555 West Middlefield Road (115 rowhouse units)



- 828 and 836 Sierra Vista Avenue (20 rowhouse units)
- 851-853 Sierra Vista Avenue (9 rowhouse units)
- 858 Sierra Vista Avenue (4 residential units)
- 2019 Leghorn Street (12,050 sq. ft. office)
- 2645 & 2655 Fayette Drive (44-unit condominium complex)

City of Palo Alto Background Development Projects

- 4256 El Camino Real (96 room hotel)
- 3406 Hillview Avenue (82,030 office and R&D)
- 3215 Porter Drive (20,833 sq. ft. office)
- 788 San Antonio Avenue (102 residential units and 1,803 sq. ft. retail)
- 1451-1601 California Avenue (180 residential units)
- 380 Cambridge Avenue (35,00 sq. ft. commercial)
- 180 El Camino Real (107,214 sq. ft. retail)
- 620 Emerson Street (2,756 sq. ft. restaurant)

City of Los Altos Background Development Projects

- 962 Acacia Avenue (600 sq. ft. commercial and 2 condominium units)
- 4856 El Camino Real (52 residential units)
- 425 First Street (20 residential units)
- 5150 El Camino Real (24 townhouse units and 172 condominium units)
- 4898 El Camino Real (28 residential units)
- 444-450 First Street (27 residential units)
- 385, 387, and 389 First Street (2,800 sq. ft. office and 10 residential units)
- 4880 El Camino Real (21 residential units)
- 97 Hillview Avenue (24,500 sq. ft. community center)
- 517 Tyndall Street (3 townhouse units)
- 170 State Street (16,505 sq. ft. restaurant and 16,495 sq. ft. office)

Traffic estimates for the development projects that would add traffic to the study intersections were estimated based on trip generation rates published in the ITE *Trip Generation Manual* (10th Edition). Vehicle trips for each of the background projects were then assigned to the roadway network based on population, employment data, and existing and estimated future travel patterns.



Intersection Analysis

Level of service calculations were prepared to evaluate intersection operations under Background and Background with Project Conditions. The intersection volumes are shown in **Figure 13** and **Figure 14**, and the corresponding LOS calculation sheets are included in **Appendix C**.

The results of the level of service calculations are presented in **Table 18**, along with the projected increases in critical delay and critical volume-to-capacity (V/C) ratios between the two conditions. The Background intersection volumes are presented in **Figure 13** and Background with Project intersection volumes are presented in **Figure 14**. Project adverse effects are identified by comparing Background without Project to Background with Project Conditions. The results of the LOS calculations indicate all the study area intersections will operate at acceptable levels of service meeting the applicable local jurisdiction's LOS threshold under Background with Project Conditions.

As under Existing Conditions, the critical delay is higher than the average delay at some intersections under Background without and with Project Conditions. This generally occurs when the minor approaches contribute higher delay than the major approaches. Additionally, some intersections operate with less delay under Background with Project Conditions compared to Background Conditions. This can occur when the project adds traffic to underutilized movements, thereby increasing the proportion of intersection trips with lower-than-average delay.

Signal Warrant Analysis

There are three intersections that were considered to side street stop sign controlled locations. If an unsignalized intersections operates at an unacceptable level of service, a signal warrant analysis is required to determine if the location should be signalized. Peak hour traffic signal warrant analyses were not required at Intersection #8 (Miller Avenue and San Antonio Road) because this stop-sign controlled intersections operate acceptably, nor at study intersection #18 (Project Driveway and San Antonio Road) or study intersection #19 (Project Driveway and California Street) are right-in-right-out driveways.



Table 18: Background and Background with Project Intersection Levels of Service

Intersection	LOS Threshold ¹	Peak Hour ²	Background Conditions		Background with Project Conditions			
			Delay ³	LOS ⁴	Delay ³	LOS ⁴	Δ in Crit. V/C ⁵	Δ in Crit. Delay ⁶
1 El Camino Real and Arastradero Road-Charleston Road (PA)*	LOS E	AM PM	33.8 41.1	C- D	33.8 41.4	C- D	0.001 0.013	0.0 0.4
2 El Camino Real and Del Medio Avenue (MV)	LOS D	AM PM	19.9 13.0	B- B	19.8 12.9	B- B	0.001 0.001	0.0 0.0
3 El Camino Real and San Antonio Road (MV)*, **	LOS E	AM PM	33.6 53.0	C- D-	33.8 53.0	C- D-	0.012 0.001	0.4 0.0
4 El Camino Real and Showers Drive (MV)**	LOS E	AM PM	22.8 26.7	C+ C	22.8 26.7	C+ C	0.003 0.002	0.0 0.1
5 El Camino Real and Ortega Avenue (MV)	LOS D	AM PM	15.6 12.2	B B	15.6 12.4	B B	0.003 0.004	0.0 0.2
6 El Camino Real and Rengstorff Avenue (MV)*	LOS E	AM PM	17.8 30.2	B C	17.8 30.4	B C	0.003 0.004	0.0 0.3
7 Fayette Drive and San Antonio Road (MV)**	LOS E	AM PM	15.6 19.7	B B-	15.5 20.3	B C+	0.001 0.033	0.0 3.9
8 Miller Avenue and San Antonio Road ⁵ (MV)**	LOS E	AM PM	11.9 11.7	B B	11.9 11.8	B B	N/A ⁷	N/A ⁷
9 Nita Avenue and San Antonio Road (PA)	LOS D	AM PM	8.8 4.8	A A	8.7 4.8	A A	0.001 0.010	0.0 0.0
10 California Street and San Antonio Road (MV)**	LOS E	AM PM	31.1 60.5	C E	31.8 63.7	C E	0.003 0.025	0.1 6.6
11 California Street and Pacchetti Way (MV)**	LOS E	AM PM	25.0 24.4	C C	24.9 24.3	C C	0.002 0.019	-0.1 0.0
12 California Street and Showers Drive (MV)**	LOS E	AM PM	31.1 31.8	C C	31.0 31.7	C C	0.002 0.010	0.0 -0.2
13 California Street and Ortega Avenue (MV)	LOS D	AM PM	26.1 19.4	C B-	26.1 19.2	C B-	0.001 0.008	0.0 -0.3
14 California Street and Rengstorff Avenue (MV)	LOS D	AM PM	31.2 34.3	C C-	31.3 34.5	C C-	0.002 0.009	0.1 0.3
15 Central Expressway and Rengstorff Avenue (SCC)	LOS E	AM PM	30.4 69.1	C E	30.6 71.8	C E	0.005 0.012	0.1 5.2
16 Middlefield Road and San Antonio Road (PA)*	LOS E	AM PM	54.4 60.4	D- E	56.3 62.2	E- E	0.009 0.011	2.7 3.3
17 Charleston Road and San Antonio Road (PA)*	LOS E	AM PM	34.5 52.4	C- D-	34.5 53.3	C- D-	0.000 0.006	0.0 1.7
18 Project Driveway and San Antonio Road (MV)**	LOS E	AM PM	10.7 12.1	B B	11.1 14.3	B B	N/A ⁷	N/A ⁷
19 Project Driveway and California Street (MV)**	LOS E	AM PM	9.8 11.6	A B	10.1 12.2	B B	N/A ⁷	N/A ⁷

Notes: (see next page)



Bold text indicates intersection operates at unacceptable level of service. **Bold and highlighted text** indicates adverse effects. PA = Palo Alto; MV = Mountain View; SCC = Santa Clara County; * = Congestion Management Program Intersection; and ** = San Antonio Center Planning Area Intersection.

1. LOS Threshold is the threshold between acceptable and unacceptable level of service.
2. AM = morning peak hour, PM = evening peak hour.
3. Whole intersection weighted average control delay expressed in seconds per vehicle calculated using methods described in the 2000 *Highway Capacity Manual*, with adjusted saturation flow rates to reflect Santa Clara County Conditions for signalized intersections. For side-street stop-controlled intersections total delay for the worst approach is reported.
4. LOS = Level of Service. LOS calculations conducted using the TRAFFIX 8.0 analysis software packages, which applies the methods described in the 2000 *Highway Capacity Manual*.
5. Change in critical volume to capacity ratio between Background Conditions and Background with Project Conditions.
6. Change in average critical movement delay between Background Conditions and Background with Project Conditions.
7. Change in critical v/c and change in critical delay are not applicable for an unsignalized intersection (#8) or the right-in-right-out driveways (#18 and #19).

Source: Fehr & Peers, 2021.



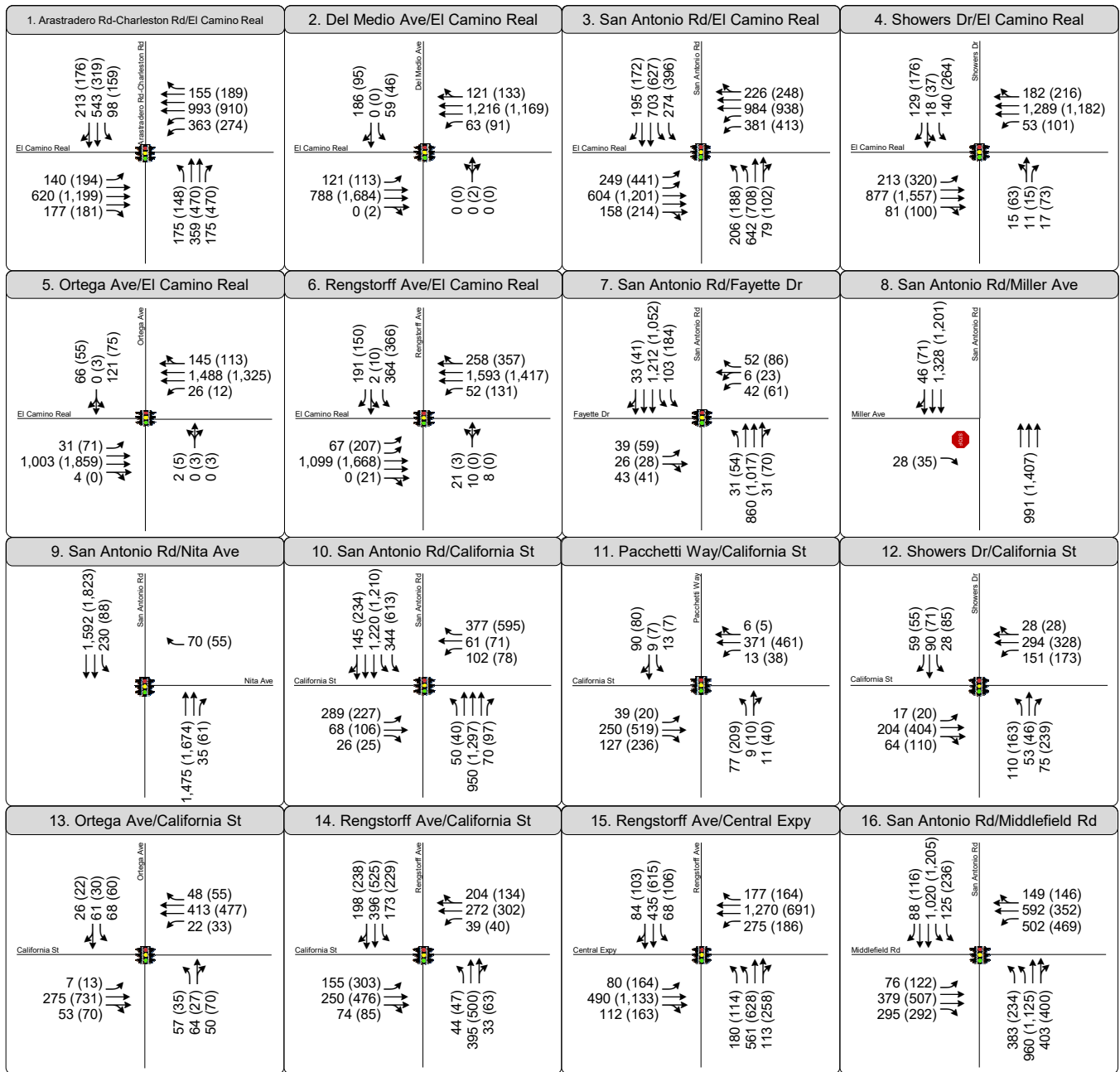

Figure 13

Background Intersection Volumes



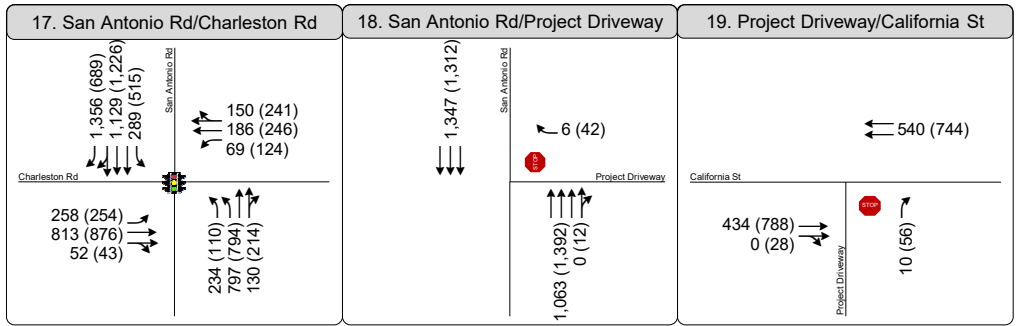

Figure 13

Background Intersection Volumes



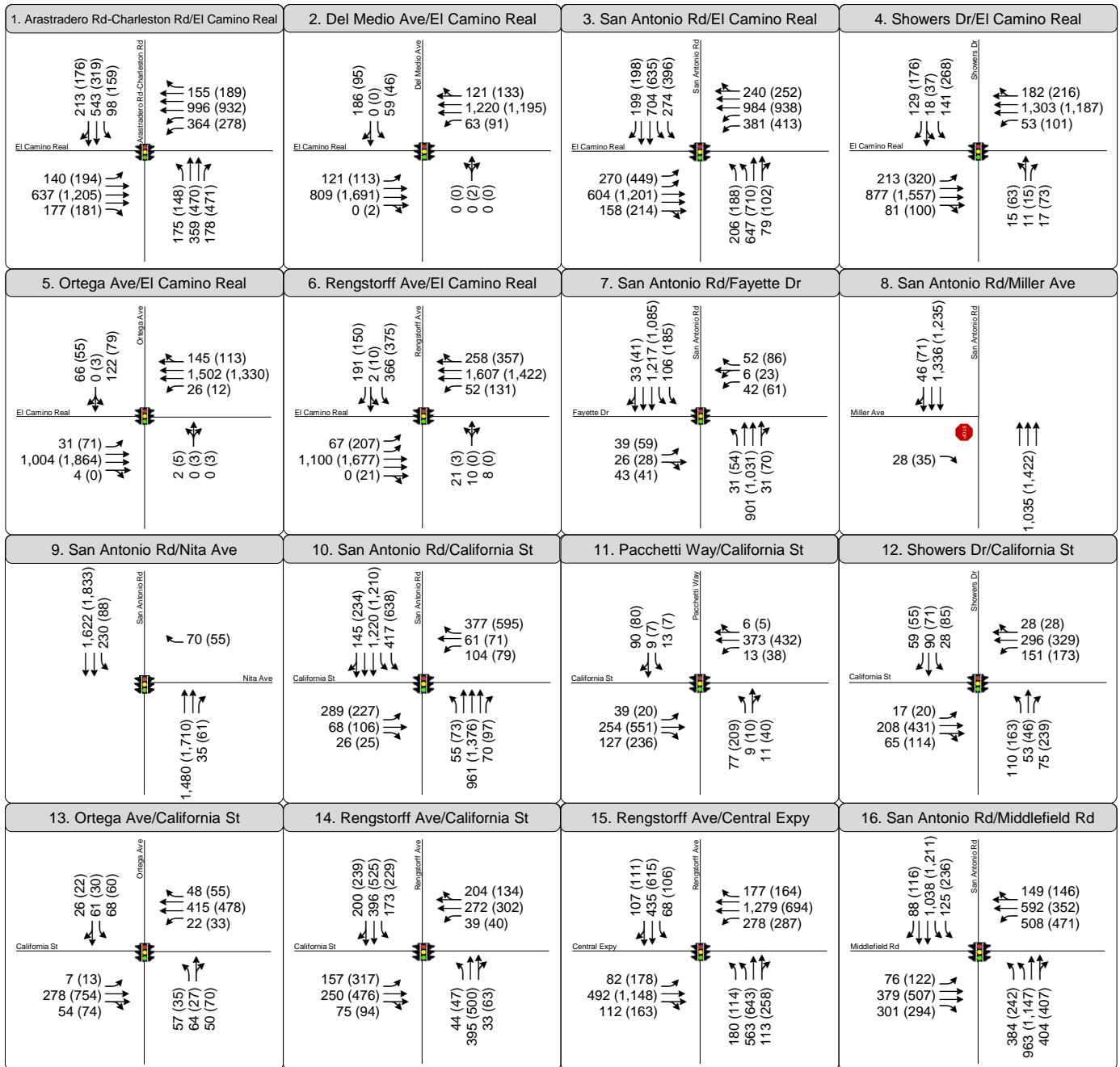

Figure 14

Peak Hour Traffic Volumes
and Lane Configurations -
Background Plus Project Conditions



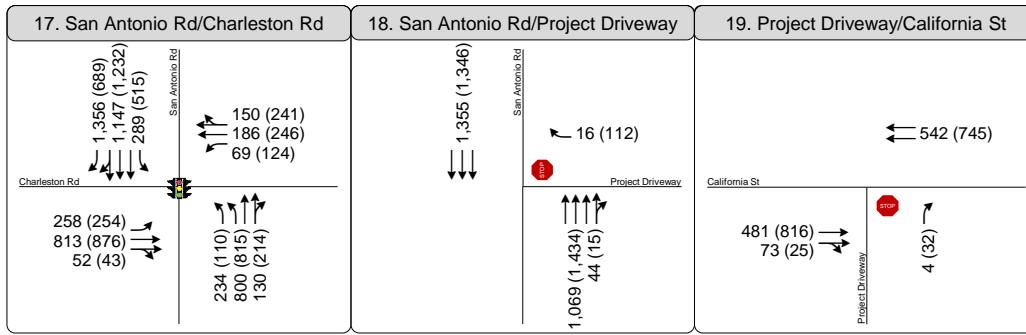

Figure 14

Peak Hour Traffic Volumes
and Lane Configurations -
Background Plus Project Conditions



10. Adverse Motor Vehicle Effects and Improvements

This chapter discusses potential project effects on the study intersections. First, the criteria for adverse effects are described. Next, the adverse effects and improvements are presented for each transportation facility type.

Adverse Effect Criteria

The determination of adverse effects in the transportation network is based on applicable policies, regulations, goals, and guidelines defined by the City of Mountain View and the Santa Clara Valley Transportation Authority. Adverse effects were evaluated by comparing the results of the analysis under Existing with Project Conditions to Existing without Project Conditions, and Background with Project Conditions to the results under Background without Project Conditions. This analysis of adverse effects uses the same tiered level of service thresholds as *The Village at San Antonio Center (Phase 2) – Final Transportation Impact Analysis* (March 2014) and which is also consistent with the *City of Mountain View 2030 General Plan and Greenhouse Gas Reduction Program Environmental Impact Report* established the following interim level of service policy standard.

As noted earlier in this report, the City of Mountain View released their *Multimodal Transportation Analysis (MTA) Handbook* during the development of this analysis. The adverse effect criteria described in this section were approved by City staff and compared to the *MTA Handbook* to ensure adequate consistency with the most recent city requirements.

Signalized Intersections

City of Mountain View

The *City of Mountain View 2030 General Plan* (July 2012) includes policies to develop and adopt multimodal transportation performance measures for projects in the City of Mountain View.

POLICY MOB 8.1: Multimodal performance measures. Develop performance measures and indicators for all modes of transportation, including performance targets that vary by street type and location.

POLICY MOB 8.2: Level of service. Ensure performance measurement criteria optimize travel by each mode.

The *City of Mountain View 2030 General Plan and Greenhouse Gas Reduction Program Environmental Impact Report* established the following interim level of service policy standards:



Interim level of service (LOS) standards. Until adoption of the mobility plans described in Action MOB 1.1.1 [and adoption of alternative impact thresholds in Action MOB 8.1.2], maintain the Citywide vehicle LOS standards from the 1992 General Plan, which include a target peak hour LOS policy of LOS D for all intersections and roadway segments, with the following exceptions in high-demand areas:

- Use LOS E for intersections and street segments within the Downtown Core and San Antonio areas where vitality, activity and multimodal transportation use are primary goals; and
- Use LOS E for intersections and street segments on CMP designated roadways in Mountain View (e.g., El Camino Real, Central Expressway and San Antonio Road).

This transportation analysis follows the interim LOS standards.

Adverse effects at signalized City of Mountain View intersections are found to occur when the addition of project traffic causes one of the following:

- Intersection operations degrade from an acceptable level to an unacceptable level; or
- Exacerbates unacceptable operations by increasing the average critical delay by four seconds or more and increasing the critical volume-to-capacity (V/C) ratio by 0.01 or more; or
- Increases the V/C ratio by 0.01 or more at an intersection with unacceptable operations when the change in critical delay is negative (i.e., decreases). This can occur if the critical movements change.

Santa Clara County and Congestion Management Program

The LOS standard for Santa Clara County expressway and Congestion Management Program (CMP) intersections is LOS E. Adverse effects at these intersections would occur when the addition of traffic associated with a project causes:

- Intersection operations to deteriorate from an acceptable level to an unacceptable level; or
- Exacerbation of unacceptable operations by increasing the average critical delay by four seconds or more and increasing the critical volume-to-capacity (V/C) ratio by 0.01 or more; or
- Increases in the V/C ratio of 0.01 or more at an intersection with unacceptable operations when the change in critical delay is negative (i.e., decreases). This can occur if the critical movements change.

Unsignalized Intersections

Level of service analysis at unsignalized intersections is generally used to determine the need for modifying the type of intersection control (i.e., installing an all-way stop or a traffic signal). Traffic volumes, delay, and traffic signal warrants are evaluated to determine if the existing intersection control is appropriate.



Based on previous studies, adverse effects are said to occur when the addition of project traffic causes the average intersection delay for an all-way stop-controlled intersection, or the worst movement/approach for a side-street stop-controlled intersection, to degrade to LOS F and the intersection satisfies the peak hour traffic signal warrant from the *California Manual of Uniform Traffic Control Devices* (MUTCD) (2014).⁷

Adverse Effects and Improvements

Intersections

Intersection adverse effects and improvements were evaluated under Existing with Project and Background with Project Conditions.

Existing with Project Conditions

The results of the LOS calculations indicate that the project does not cause an adverse effect at any study intersection under Existing with Project Conditions based on the thresholds outlined in above, and therefore no improvements are required.

Background with Project Conditions

The results of the LOS calculations indicate that the project does not cause an adverse effect at any study intersection under Background with Project Conditions based on the thresholds outlined in above, and therefore no improvements are required.

⁷ The peak-hour signal warrant analysis should not serve as the only basis for deciding whether and when to install a traffic signal. To reach such a decision, the full set of warrants should be investigated based on a thorough study of traffic and roadway conditions by an experienced engineer. The decision to install a signal should not be based solely upon the warrants, since the installation of signals can lead to certain types of collisions. The responsible state or local agency should undertake regular monitoring of actual traffic conditions and accident data and timely re-evaluation of the full set of warrants to prioritize and program intersections for signalization.



Active Transportation and Transit Operations Analysis



11. Pedestrian Operations

As noted in the Analysis Approach section earlier in this report, this MTA is a supplemental transportation analysis (TA) that builds upon the *SAPP EIR* and the *SAPP TA*. The *SAPP TA* has already completed the MTA analysis that is outlined in the recently released City of Mountain View *Multi-Modal Transportation Analysis Handbook* (February 2021) for the entire plan area. Most of the existing public street improvements identified in the *SAPP* along the project frontage are built, but some of the key intersection improvements remain. This MTA supplements the pedestrian operations from the *SAPP TA* by providing:

- 1) Summary of planned pedestrian infrastructure near the project site identified in San Antonio Precise Plan.
- 2) Evaluation of the pedestrian access to the project site and estimated pedestrian activity in Chapter 4 Site Access and On-Site Circulation of this MTA.
- 3) Summary the pedestrian access to nearby destinations using a pedestrian walkshed on the existing and planned transportation network.

Pedestrian Infrastructure

The *SAPP TA* areawide pedestrian improvements near the project site include pedestrian circulation through a network of sidewalks. Improved circulation is a critical building block for achieving the *SAPP* vision. The overall circulation concept provides direction for improvements to public street rights-of-way (ROW), including pedestrian and bicycle improvements, and future internal roadways on private development sites. Primary pedestrian routes, as defined by the *SAPP*, are along San Antonio Road and California Street, both of which are within the Phase III project area. Primary routes should be prioritized for improvement and align with open space, active building frontages with pedestrian-scaled features, and other important destinations. Silicon Way, to the east of the project site, is a Secondary Pedestrian Route as defined by the *SAPP*. Secondary pedestrian routes occur mostly along new interior connections or existing streets with limited pedestrian improvements. In the *SAPP*, key pedestrian objectives for all streets include:

- Continuous sidewalks wide enough to accommodate two or more people passing each other at one time.
- Pedestrian crossing improvements at current and future intersections.
- Direct connections to transit and destinations, such as parking garages and home/work/shopping areas.
- Attractive streetscape landscaping, including new street trees.



Pedestrian Access to Nearby Destinations

The San Antonio Precise Plan defines the cross-sections of streets and pathways in the plan area with a particular focus on improving the connectivity, directness of travel, and quality of the bicycle and pedestrian facilities. This future pedestrian and bicycle system will be comprehensive and low stress.

This pedestrian walkshed analysis shows the 5, 10, and 15-minute walk times of the project under the existing and planned *SAPP* transportation network (see **Figure 16**).

Within a 15-minute walk leaving the project site under existing conditions pedestrians are only able to access up to past El Camino Real, but with future walking conditions, the 10- and 15-minute walking sheds give pedestrians access to a greater area of Mountain View including the Mountain View Community Center. These increases in walking access are due to the updates in the public circulation network from the *SAPP*, shown in **Figure 15**. Over time the quality of the walking access to the project site will improve as the *SAPP* streets are constructed.

Pedestrian Quality of Service

Pedestrian Quality of Service (QOS) is rated from 1 to 5, with 1 being the best quality and 5 the lowest. AccessMV provides pedestrian QOS maps that use a combination of WalkScore, Missing Sidewalks, Posted Speed Limits, and Road Type to determine pedestrian quality. Based on the Pedestrian QOS evaluation from AccessMV, the existing quality of service for San Antonio Road near the project site is a QOS 4, while the QOS on California is the lowest at a QOS 5. See the Pedestrian Quality of Service on **Figure 17** from AccessMV. As presented in **Figure 8**, the proposed pedestrian paths throughout the site provide access to the frontages of California Street and San Antonio Road, and to the adjacent San Antonio Village Phase II buildings to the south and to the east. Additionally, the pedestrian paths provide connectivity to the sidewalks on San Antonio Road and California Street. The pedestrian facilities within the project site are consistent with the goals and policies outlined in the *SAPP*. The quality of service to the pedestrian network will improve once these are constructed.

ADA Compliance

The project proposes an ADA Ramp and Signage on the northeast corner of the site on the intersection. The project site has an existing Crosswalk ADA ramp on both the northeast and the northwest corners of the site. The site provides accessible paths from streets and parking lots to building entrances.



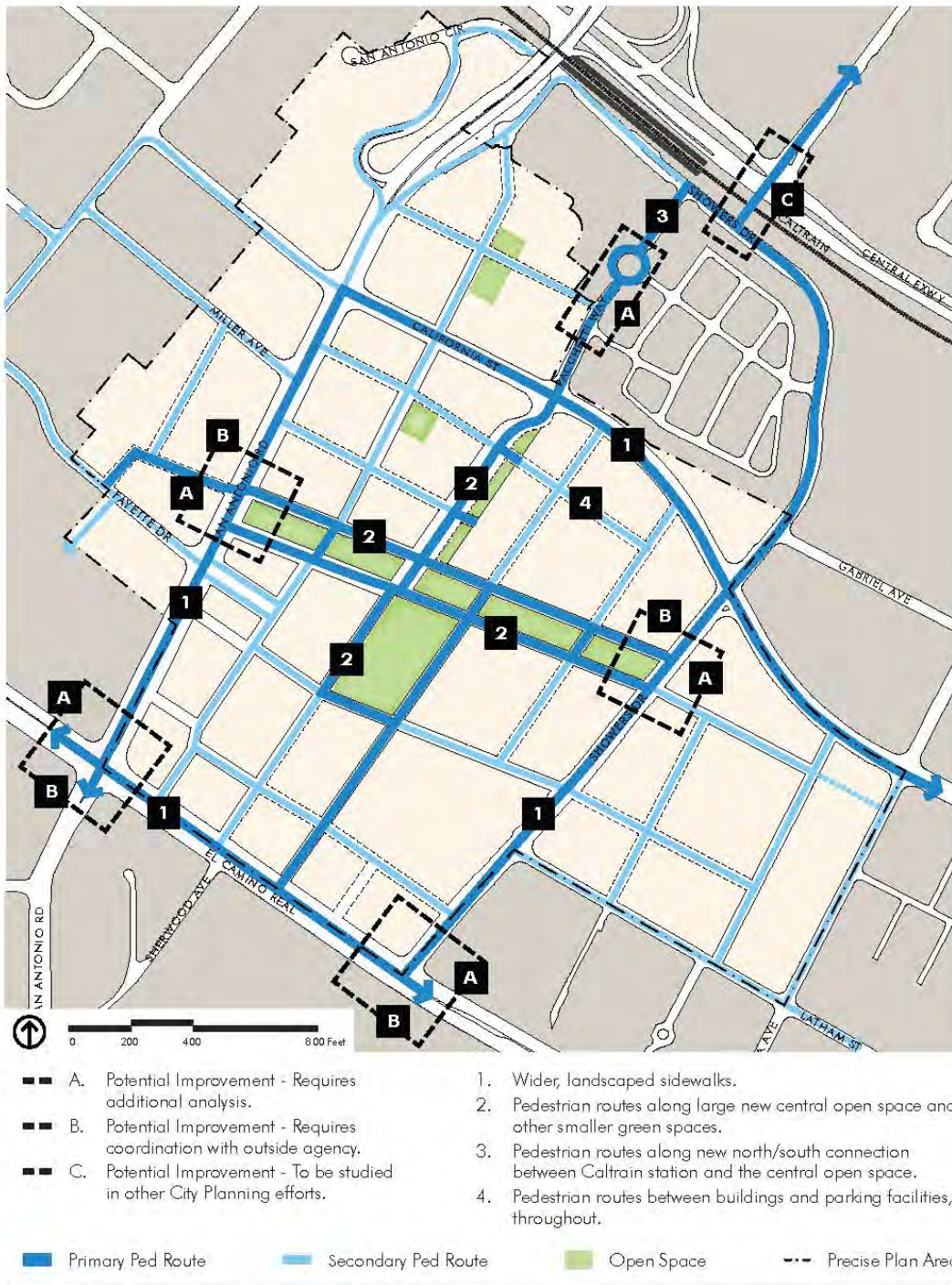
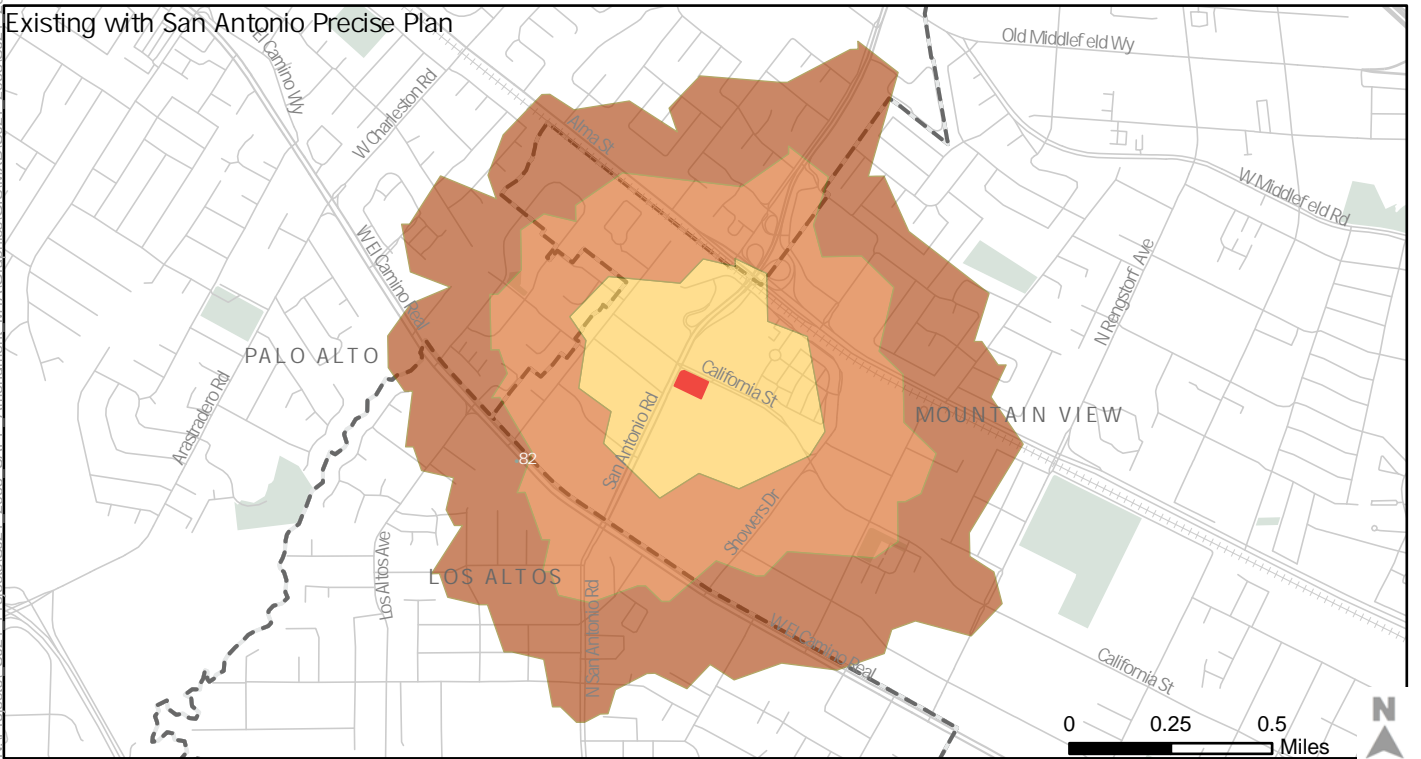
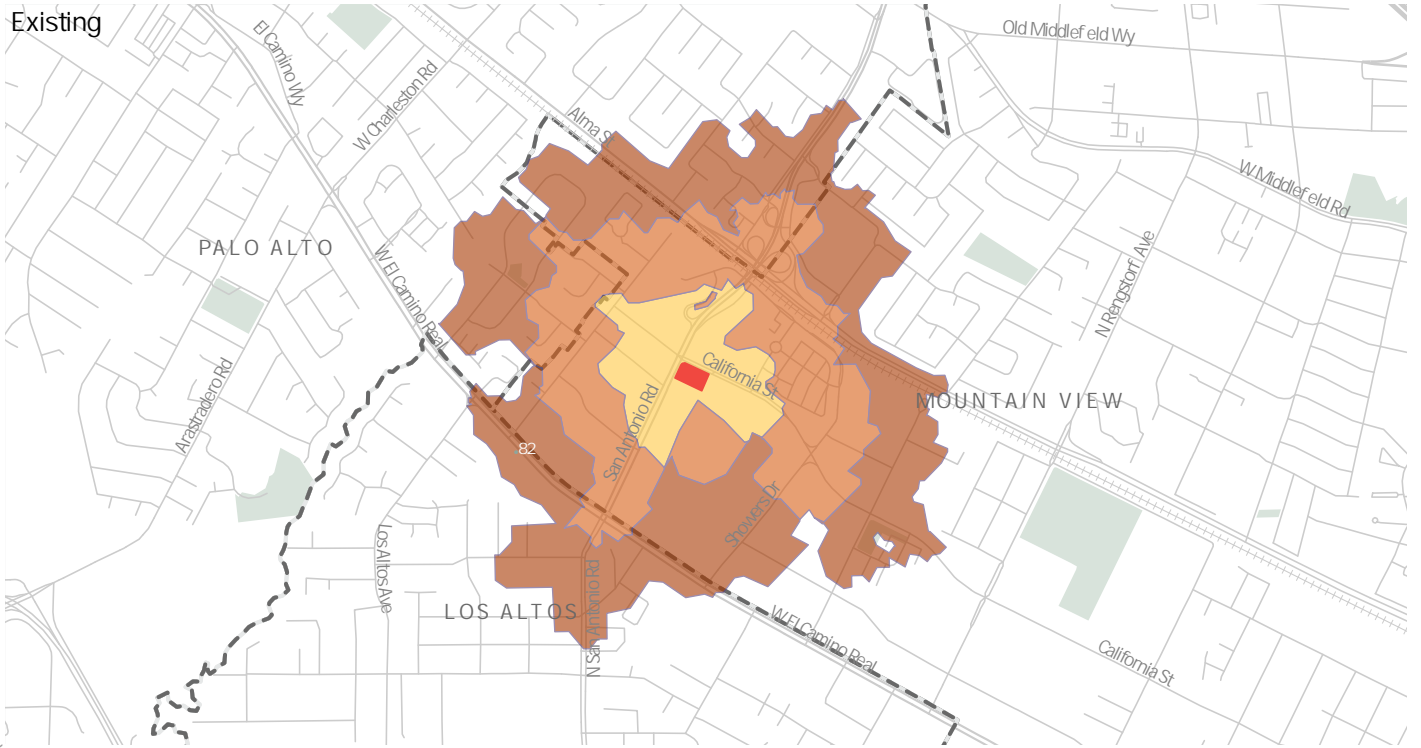

FIGURE 2-3 Pedestrian Circulation Plan

Source: San Antonio Precise Plan, Mountain View 2015



Figure 15
Pedestrian Circulation Plan from San Antonio Precise Plan



- Project Site
- City Boundaries
- 5 minute walk
- 10 minute walk
- 15 minute walk



Figure 16
Existing and Future Pedestrian Sheds

Figure 3-5. Pedestrian Quality of Service



N:\Projects\SJ21_Projects\SJ21_2068_SAPP_Amendment_MTA\Graphics\GIS\MXD\SJ21_2068.aprx

Source: AccessMV, Mountain View 2021 (Page 29)



Figure 17
Pedestrian Quality of Service from AccessMV

12. Bicycle Operations

As noted in the Analysis Approach section earlier in this report, this MTA is a supplemental transportation analysis (TA) that builds upon the *SAPP EIR* (2014). This MTA supplements the bicycle operations from the *SAPP EIR* by providing:

- 1) An evaluation of the bicycle access to the project site and estimated bicycle activity in Chapter 4 Site Access and On-Site Circulation of this MTA.
- 2) Summary of planned pedestrian infrastructure near the project site identified in the San Antonio Precise Plan.
- 3) This chapter summarizes the pedestrian access to nearby destinations using a bicycle walkshed on the existing and planned transportation network.

Bicycle Access to Nearby Destinations

The San Antonio Precise Plan defines the cross-sections of streets and pathways in the plan area with a particular focus on improving the connectivity, directness of travel, and quality of the bicycle and pedestrian facilities. This future bicycle system will be comprehensive and low stress and will include connections to the light rail stations. This bicycle walkshed analysis shows the 5, 10, and 15-minute bicycle times of the project under existing and planned *SAPP* transportation network (see **Figure 18**).

San Antonio Road and California Street is defined by the *SAPP* as a key intersection. This means the intersection directs vehicle access to the *SAPP* Plan Area and provides an important connection for the east-west bicycle circulation. In addition to typical pedestrian access improvements, the intersection design should focus on managing vehicle operations and opportunities to provide improved intersection striping for bicycles.

The quality of the bike ride changes for the existing and future conditions comparing 10- and 15-minute bicycle sheds. In future conditions, cyclists can access Downtown. The streets go from being high stress to low stress, therefore making cyclists more comfortable.

Planned Bicycle Infrastructure

The *SAPP* proposes a primary bicycle route along California Avenue and San Antonio Avenue, defined by *SAPP*. Primary bicycle route objectives include:

- Integrated bicycle network, with facilities that close existing gaps.
- Improved existing bike facilities and new connections through large blocks.
- Clear wayfinding signage and well-marked routes.



- Bicycle crossing improvements at current and future intersections.

Silicon Way is defined as a Secondary Bicycle Facility, which is defined by *SAPP* as including potential improvements to existing facilities and new bike facilities. These secondary facilities provide additional linkages to surrounding areas, including northern Mountain View and Palo Alto to the north; Rengstorff Park and Downtown Mountain View to the east; Downtown Los Altos to the south; and Palo Alto to the west. These facilities are shown in **Figure 19** from the *SAPP*.

The project does not propose any new onsite or off-site bicycle pathways. Signs will be posted at the project driveways directing bicyclists to dismount and walk their bikes around the project site. The project includes new indoor, secure bicycle parking facilities. Bicyclists would access the bicycle storage room via building access at the southeast corner on the intersection of San Antonio Road and California Street.

Bicycle User Experience (LTS)

Level of Traffic Stress (LTS) is closely related to the Four Types of Cyclists theory with the following types:

- strong and fearless,
- enthused and confident,
- interested and concerned, and
- no-way no-how.

The majority of cyclists are generally considered to be interested and concerned.

Whereas the Four Types of Cyclists theory highlights people's willingness to bicycle, LTS measures the quality of a person's experience while bicycling. Low stress bikeways (LTS 1 and 2) are generally tolerated by most cyclists; in contrast, high stress bikeways are only tolerated by Strong and Fearless cyclists. The development of a low-stress network and elimination of high-stress barriers is critical to broaden the appeal of bicycling, especially for Enthused and Confident and Interested but Concerned cyclists.

An LTS analysis was conducted as part of *AccessMV* using the existing and future network to assess changes in LTS ratings. Under existing conditions, Shoreline is an LTS 3 and California is an LTS 3, but with Future Conditions, both roadways improve to an LTS 2. With these bicycle facilities, the Level of Traffic Stress is shown to be less stressful for most bicyclists within the Plan area. **Figure 20** shows the Existing LTS Network from *AccessMV*, and **Figure 21** shows the future LTS Network from *AccessMV*.



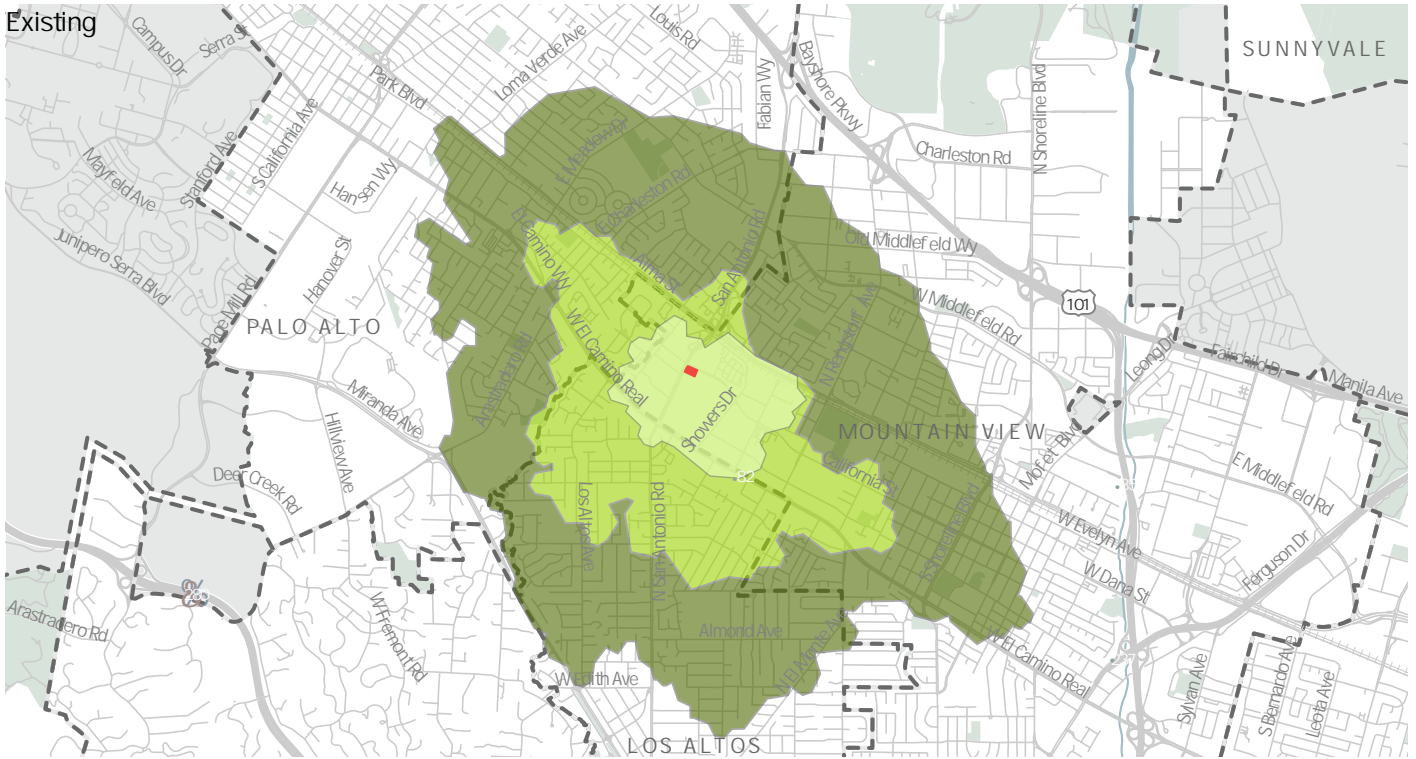

N:\Projects\ SJ21_P\Projects\SJ21_2068_SAPP_Amendment_MTA\Graphics\GIS\MXD\SJ21_2068\SJ21_2068.aprx

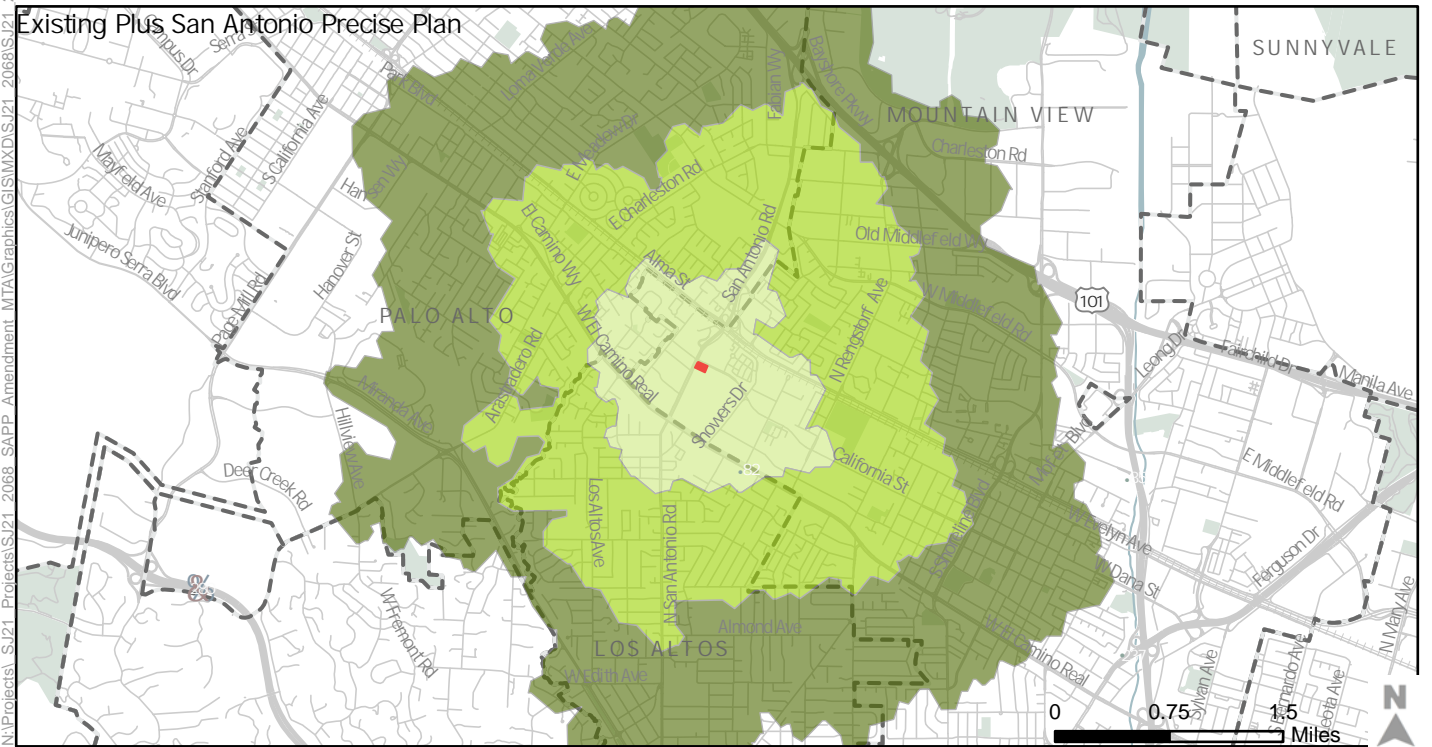

- Project Site
- City Boundaries
- ToBreak 5
- ToBreak 10
- ToBreak 15



Figure 18
Existing and Future Bicycle Sheds

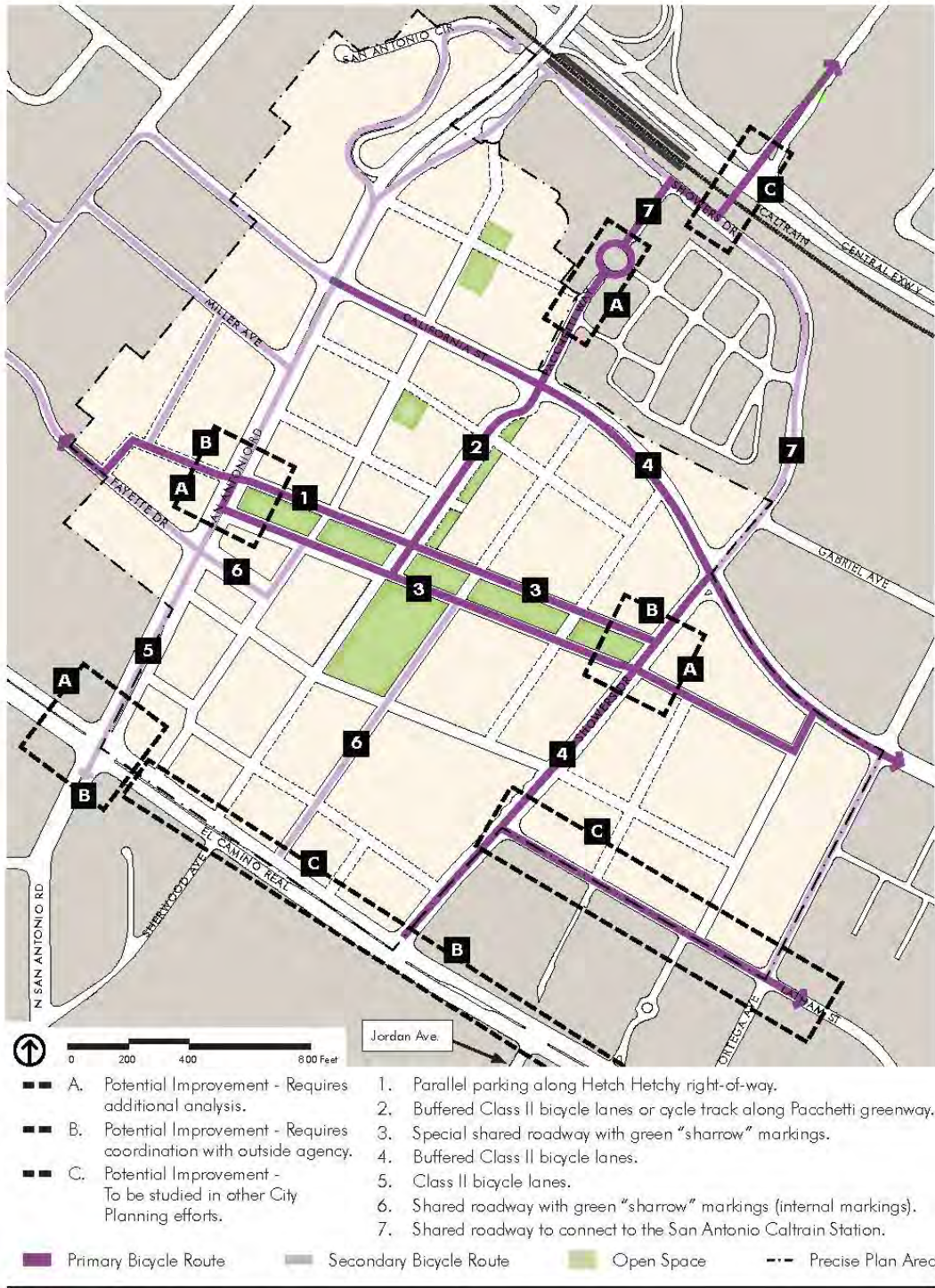

FIGURE 2-4 Bicycle Circulation Plan

Source: San Antonio Precise Plan, Mountain View 2015



Figure 3-10. Existing Bicycle Level of Traffic Stress



Source: AccessMV, Mountain View 2021 (Page 35)

N:\Projects\SU21_Projects\SU21_2068_SAPP_Amendment_MTA\Graphics\GIS\MXD\SU21_2068.aprx



Figure 20

Existing Bicycle Level of Traffic Stress from AccessMV

Figure 3-12. Planned Bicycle Level of Traffic Stress

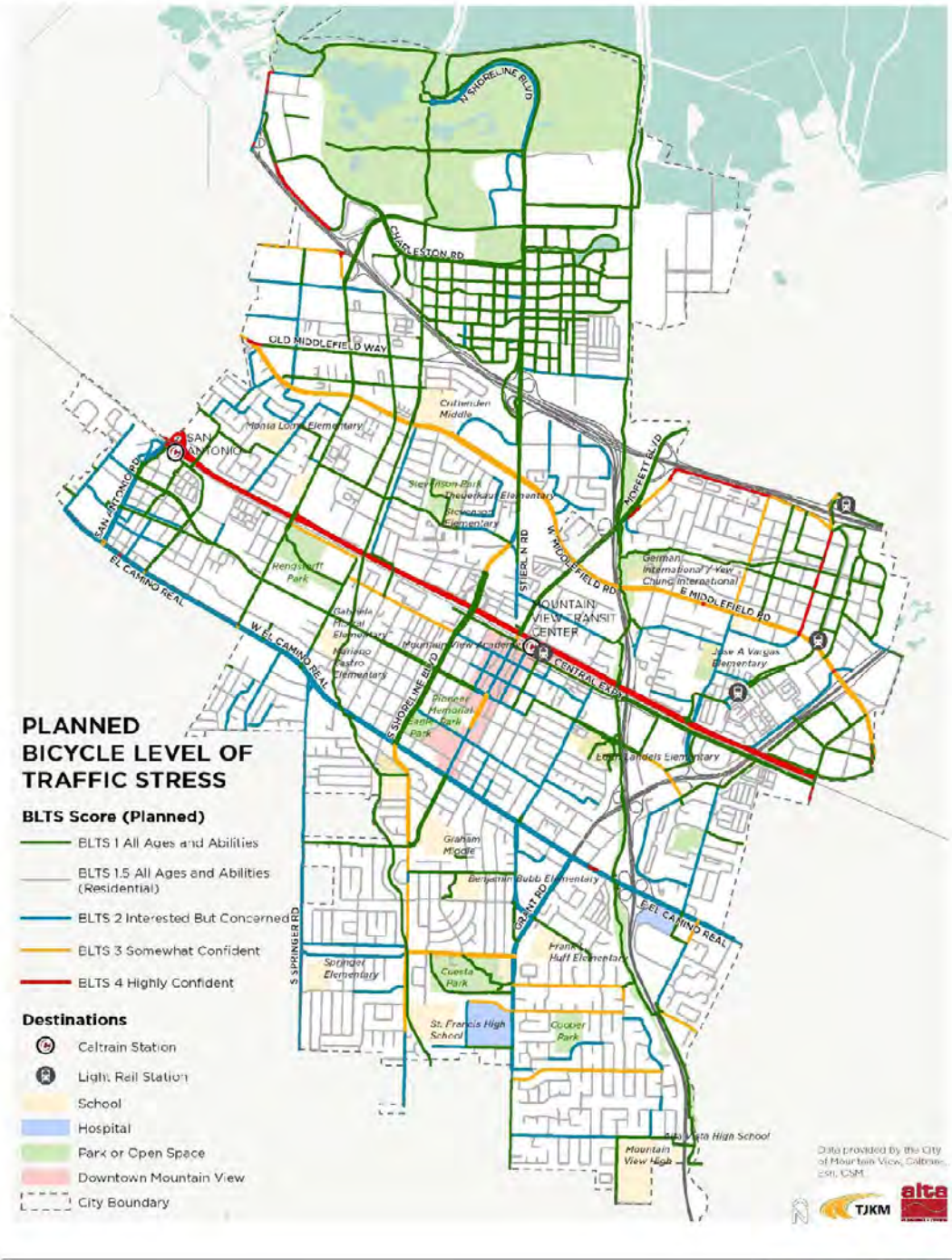

Source: AccessMV, Mountain View 2021 (Page 31)

N:\Projects\SU21_Projects\SU21_2068_SAPP_Amendment_MTA\Graphics\GIS\MXD\SU21_2068\SU21_2068.aprx



Figure 21
Future Bicycle Level of Traffic Stress from AccessMV

13. Transit Operations

As noted in the Analysis Approach section earlier in this report, this MTA is a supplemental transportation analysis that builds upon the *SAPP EIR* (2014). This MTA supplements the transit operations from the *SAPP EIR* by providing:

- 1) Transit Facilities and Improvements: A summary of the nearby transit improvements highlighted in the *SAPP*.
- 2) Access to Transit: A summary of access to transit by walking or biking.
- 3) Transit Operations: A summary of the strategies to minimize transit delay.

Transit Facilities and Improvements

The project is within a half-mile walk of rail and bus transit stops. The San Antonio Caltrain Station is north of the project site on Showers Drive. The Santa Clara County Valley Transportation Agency (VTA) operates bus service within and surrounding the Plan Area. The San Antonio Transit Center on Showers Drive at Latham Street is the transfer station for four regional bus routes that serve Santa Clara County which are routes 21, 22, 40, 522.

The *SAPP*'s primary transit objectives include:

- Direct pedestrian and bicycle connections to transit stations and stops.
- Coordination with associated transit agencies to integrate pedestrian and bicycle facilities with station and stop designs.
- Building and site design oriented to transit connections and transit stations/stops.
- Transportation demand management programs and standards supporting transit use.

The project site must follow the *SAPP*'s primary transit objectives to increase transit accessibility for bicyclists and pedestrians. As the area develops, public shuttle route coverage and service frequency should be increased, including increased access to regional transit, according to the *SAPP*. Currently, the site is served by the following providers:

Caltrain

Caltrain provides inter- and intra-county commuter rail service from San Francisco County to the north, through San Mateo County, to Santa Clara County in the south. The Peninsula Corridor Joint Powers Board operates Caltrain 365 days a year, with reduced schedules on weekends and major U.S. holidays. Weekday trains are a mix of Baby Bullet, Limited, and Local trains. Caltrain currently operates 46 northbound and 46 southbound (total of 92) trains per day between San Jose and San Francisco during



the week. The San Antonio Station is approximately 1/4 mile to the north of the Plan area. The San Antonio Station serves approximately 943 boardings per weekday (Caltrain, 2018).

VTA Bus

The existing transit service is summarized in **Chapter 3**. Route 21 operates on Middlefield Road and California Road with two bus stops in the project area at the intersection of California Street and San Antonio Road and California Street and Pachetti Way. The headways (time between successive buses) are 30 minutes during weekdays and hourly on Saturdays. The headways are 45 minutes on Sundays. Route 22 runs on El Camino Real with one stop to the west of the project area on El Camino Real and Showers Drive. The headways are 20 minutes during the weekdays, 20 minutes Saturdays, and 30 minutes on Sundays. Route 40 operates on Foothill Expressway and Rengstorff with one stop to the east of the project area at California Street and Showers Drive. The headways are 55 minutes during the weekdays, 50 minutes on Saturdays, and 45 minutes on Sundays. Route 522 provides twice daily northbound and twice daily southbound transit trips along Manila Drive and Ellis Street all other Route 120 trip terminate at the Lockheed Martin Transit Center. The headways are 20 minutes during the weekday.

Access to Transit

The *SAPP* describes access to transit as existing pedestrian and bicycle access to stations and public bus stops will be enhanced with new connections.

The project site is within 1/4 mile walk of the San Antonio Caltrain station, and 1/2 mile walk of the San Antonio Transit Center and Proposed VTA Bus Rapid transit station. The project site will have access to these transit stations with new connections such as increased sidewalk access and bike lanes.

Transit Operations

There may be some transit operational delay due to additional vehicles on the roadway. Within the *San Antonio Precise Plan* there aren't any additional transit priority improvements. In the Mountain View General Plan mobility section, the Street Types Table 4.2 shows Street Types with mode priority, within this table, El Camino would be the only transit priority street. A Boulevard is defined as a major arterial with high frequency of transit service and mixed commercial and retail frontages. The guidelines from the General Plan are to provide access and safe crossings for all travel modes along a regional transportation corridor, including transit. To emphasize transit and accommodate regional vehicle trips to discourage such trips on nearby local roadways, the project team and City staff should collaborate with other cities and agencies where facilities cross jurisdictional boundaries.



14. Parking Assessment

The parking facilities on the project site will contain a total 283 spaces. The SAPP requires parking consistent with the City’s Zoning Ordinance §36.32.50b parking standards. A potential reduction can be received if the project is within 1,000 feet walking distance of Caltrain or proposed Rapid Bus Access (10 percent reduction) or the Applicant has a parking or TDM program (10 percent reduction).

Table 19 outlines the vehicle parking requirements by land use type according to the City of Mountain View’s Code of Ordinances §36.32.50b. The City of Mountain View Code requires one space for each 300 square feet of ground floor area for office, and one space for each 180 square feet of ground floor area for retail.

Based on the amount of office and retail use, the project is required to provide 573 parking spaces. However, the project is only providing 283 parking spaces, netting a parking supply shortfall of 290 parking spaces. A shared parking plan has been prepared for the project by other consultants describing how parking facilities will be shared with San Antonio Village Phase II such that all parking demand is met by the onsite supply. The shared parking plan follows the analysis methods described in the Urban Land Institute’s (ULI’s) *Shared Parking*, Third Edition, and it relies on sharing parking between land uses that have peak parking demands at different times of day, reducing the total number of spaces required under an unshared parking configuration. Both Fehr & Peers and City staff have reviewed the project’s shared parking plan for adequacy and consistency with standard practices.

Table 19: Vehicle Parking Requirements

Land Use	Size (ksf)	Parking Requirements	Parking Supply (spaces)
Office	169.382	1 space for each 300 s.f. of GFA	565
Retail	12.970	1 space for each 180 s.f. of GFA	72
Total Vehicle Parking Spaces Required			637
10% reduction: 1,000 ft walking distance to Caltrain			64
Total Vehicle Parking Spaces Required with Reduction			573

Source: Fehr & Peers, 2021.

The City-recommended bicycle parking supply for office and retail uses is a number equal to 5% of vehicle spaces. The project is providing 16 short term bicycle parking spaces and 16 long-term bicycle parking spaces. Total bicycle parking spaces for the project Site amounts to 32 bicycle stalls. This meets the City’s requirements. The calculation of required bicycle parking spaces is shown in **Table 20**. All bike parking should be conveniently located in well-lit locations, near entrances and consistent with VTA *Bicycle Technical Guidelines* (December 2012).



Table 20: Bicycle Parking Requirements

Land Use	Size (ksf)	Bicycle Parking Requirements	Required Vehicle Parking Supply (spaces)	Bicycle Parking Supply (spaces)
Office	169.382	5 percent of vehicle spaces	565	28
Retail	12.970	5 percent of vehicle spaces	72	4
Total Bicycle Parking Spaces Required				32

Source: Fehr & Peers, 2021.



Appendix A: Intersection Turning Movement Counts

Traffic Data Service

San Jose, CA
(408) 622-4787
tdsbay@cs.com

File Name : 1AM FINAL
Site Code : 00000001
Start Date : 4/27/2021
Page No : 1

Groups Printed- Lights - Buses - Trucks

Start Time	EL CAMINO REAL Southbound					W CHARLESTON RD Westbound					EL CAMINO REAL Northbound					ARASTRADERO RD Eastbound					Int. Total
	Right	Thru	Left	Peds	App. Total	Right	Thru	Left	Peds	App. Total	Right	Thru	Left	Peds	App. Total	Right	Thru	Left	Peds	App. Total	
07:00 AM	4	39	5	1	49	15	47	5	0	67	11	75	41	0	127	9	14	5	1	29	272
07:15 AM	8	38	14	1	61	24	56	4	0	84	10	93	44	0	147	12	17	6	2	37	329
07:30 AM	14	64	18	1	97	18	81	8	1	108	9	105	56	1	171	21	26	7	1	55	431
07:45 AM	14	68	17	2	101	25	74	7	0	106	17	125	69	2	213	21	33	13	0	67	487
Total	40	209	54	5	308	82	258	24	1	365	47	398	210	3	658	63	90	31	4	188	1519
08:00 AM	11	69	17	1	98	41	55	11	1	108	18	139	47	4	208	16	43	25	0	84	498
08:15 AM	21	103	24	3	151	27	86	15	0	128	17	117	49	2	185	25	56	24	0	105	569
08:30 AM	27	84	12	4	127	25	71	14	4	114	33	127	36	6	202	17	42	16	1	76	519
08:45 AM	37	72	23	3	135	23	83	13	2	121	16	134	59	6	215	36	54	30	2	122	593
Total	96	328	76	11	511	116	295	53	7	471	84	517	191	18	810	94	195	95	3	387	2179
Grand Total	136	537	130	16	819	198	553	77	8	836	131	915	401	21	1468	157	285	126	7	575	3698
Apprch %	16.6	65.6	15.9	2		23.7	66.1	9.2	1		8.9	62.3	27.3	1.4		27.3	49.6	21.9	1.2		
Total %	3.7	14.5	3.5	0.4	22.1	5.4	15	2.1	0.2	22.6	3.5	24.7	10.8	0.6	39.7	4.2	7.7	3.4	0.2	15.5	
Lights	134	504	126	16	780	191	535	76	8	810	127	867	391	21	1406	152	278	124	7	561	3557
% Lights	98.5	93.9	96.9	100	95.2	96.5	96.7	98.7	100	96.9	96.9	94.8	97.5	100	95.8	96.8	97.5	98.4	100	97.6	96.2
Buses	1	15	0	0	16	1	1	0	0	2	0	15	0	0	15	1	1	0	0	2	35
% Buses	0.7	2.8	0	0	2	0.5	0.2	0	0	0.2	0	1.6	0	0	1	0.6	0.4	0	0	0.3	0.9
Trucks	1	18	4	0	23	6	17	1	0	24	4	33	10	0	47	4	6	2	0	12	106
% Trucks	0.7	3.4	3.1	0	2.8	3	3.1	1.3	0	2.9	3.1	3.6	2.5	0	3.2	2.5	2.1	1.6	0	2.1	2.9

Start Time	EL CAMINO REAL Southbound				W CHARLESTON RD Westbound				EL CAMINO REAL Northbound				ARASTRADERO RD Eastbound				Int. Total
	Right	Thru	Left	App. Total	Right	Thru	Left	App. Total	Right	Thru	Left	App. Total	Right	Thru	Left	App. Total	
Peak Hour Analysis From 07:00 AM to 08:45 AM - Peak 1 of 1																	
Peak Hour for Entire Intersection Begins at 08:00 AM																	
08:00 AM	11	69	17	97	41	55	11	107	18	139	47	204	16	43	25	84	492
08:15 AM	21	103	24	148	27	86	15	128	17	117	49	183	25	56	24	105	564
08:30 AM	27	84	12	123	25	71	14	110	33	127	36	196	17	42	16	75	504
08:45 AM	37	72	23	132	23	83	13	119	16	134	59	209	36	54	30	120	580
Total Volume	96	328	76	500	116	295	53	464	84	517	191	792	94	195	95	384	2140
% App. Total	19.2	65.6	15.2		25	63.6	11.4		10.6	65.3	24.1		24.5	50.8	24.7		
PHF	.649	.796	.792	.845	.707	.858	.883	.906	.636	.930	.809	.947	.653	.871	.792	.800	.922

Traffic Data Service

San Jose, CA
 (408) 622-4787
 tdsbay@cs.com

File Name : 1AM FINAL
 Site Code : 00000001
 Start Date : 4/27/2021
 Page No : 2

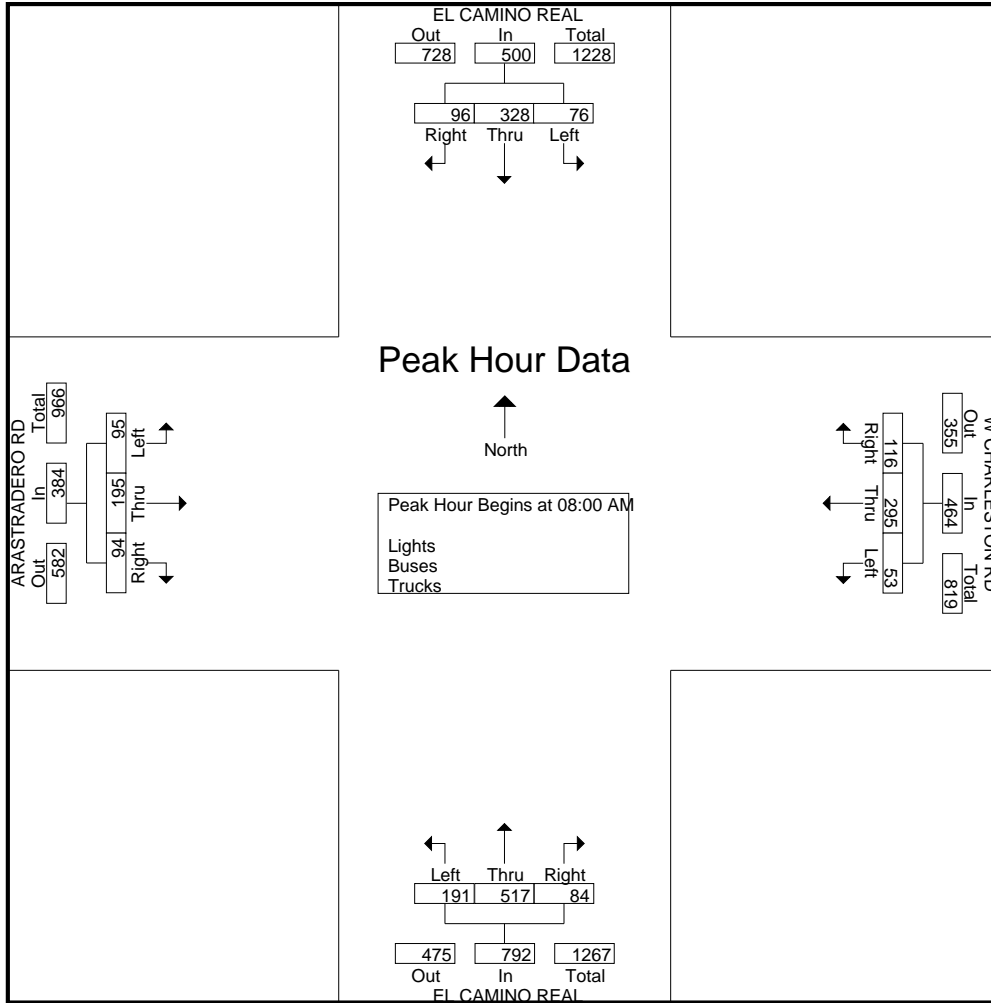

Traffic Data Service

San Jose, CA
 (408) 622-4787
 tdsbay@cs.com

File Name : 1AM FINAL
 Site Code : 00000001
 Start Date : 4/27/2021
 Page No : 1

Groups Printed- Bikes

Start Time	EL CAMINO REAL Southbound					W CHARLESTON RD Westbound					EL CAMINO REAL Northbound					ARASTRADERO RD Eastbound					Int. Total
	Right	Thru	Left	Peds	App. Total	Right	Thru	Left	Peds	App. Total	Right	Thru	Left	Peds	App. Total	Right	Thru	Left	Peds	App. Total	
07:00 AM	0	0	0	0	0	0	0	0	0	0	0	0	0	0	0	0	0	0	0	0	0
07:15 AM	0	0	0	0	0	0	0	0	0	0	0	0	0	0	0	0	0	0	0	0	0
07:30 AM	0	0	0	0	0	0	0	0	0	0	0	0	0	0	0	0	1	0	0	1	1
07:45 AM	0	0	0	0	0	2	2	0	0	4	0	1	0	0	1	0	1	0	0	1	6
Total	0	0	0	0	0	2	2	0	0	4	0	1	0	0	1	0	2	0	0	2	7
08:00 AM	0	0	0	0	0	0	1	0	0	1	0	0	0	0	0	0	1	0	0	1	2
08:15 AM	0	0	0	0	0	0	1	0	0	1	0	0	0	0	0	0	1	0	0	1	2
08:30 AM	0	0	0	0	0	1	2	0	0	3	0	0	0	0	0	0	1	0	0	1	4
08:45 AM	0	0	0	0	0	1	2	0	0	3	0	0	0	0	0	0	1	0	0	1	4
Total	0	0	0	0	0	2	6	0	0	8	0	0	0	0	0	0	4	0	0	4	12
Grand Total	0	0	0	0	0	4	8	0	0	12	0	1	0	0	1	0	6	0	0	6	19
Apprch %	0	0	0	0	0	33.3	66.7	0	0		0	100	0	0		0	100	0	0		
Total %	0	0	0	0	0	21.1	42.1	0	0	63.2	0	5.3	0	0	5.3	0	31.6	0	0	31.6	

Start Time	EL CAMINO REAL Southbound					W CHARLESTON RD Westbound					EL CAMINO REAL Northbound					ARASTRADERO RD Eastbound					Int. Total
	Right	Thru	Left	Peds	App. Total	Right	Thru	Left	Peds	App. Total	Right	Thru	Left	Peds	App. Total	Right	Thru	Left	Peds	App. Total	
07:45 AM	0	0	0	0	0	2	2	0	0	4	0	1	0	0	1	0	1	0	0	1	6
08:00 AM	0	0	0	0	0	0	1	0	0	1	0	0	0	0	0	0	1	0	0	1	2
08:15 AM	0	0	0	0	0	0	1	0	0	1	0	0	0	0	0	0	1	0	0	1	2
08:30 AM	0	0	0	0	0	1	2	0	0	3	0	0	0	0	0	0	1	0	0	1	4
Total Volume	0	0	0	0	0	3	6	0	0	9	0	1	0	0	1	0	4	0	0	4	14
% App. Total	0	0	0	0	0	33.3	66.7	0	0		0	100	0	0		0	100	0	0		
PHF	.000	.000	.000	.000	.000	.375	.750	.000	.000	.563	.000	.250	.000	.000	.250	.000	1.00	.000	.000	1.00	.583

Peak Hour Analysis From 07:00 AM to 08:45 AM - Peak 1 of 1
 Peak Hour for Entire Intersection Begins at 07:45 AM

Traffic Data Service

San Jose, CA
 (408) 622-4787
 tdsbay@cs.com

File Name : 1AM FINAL
 Site Code : 00000001
 Start Date : 4/27/2021
 Page No : 2

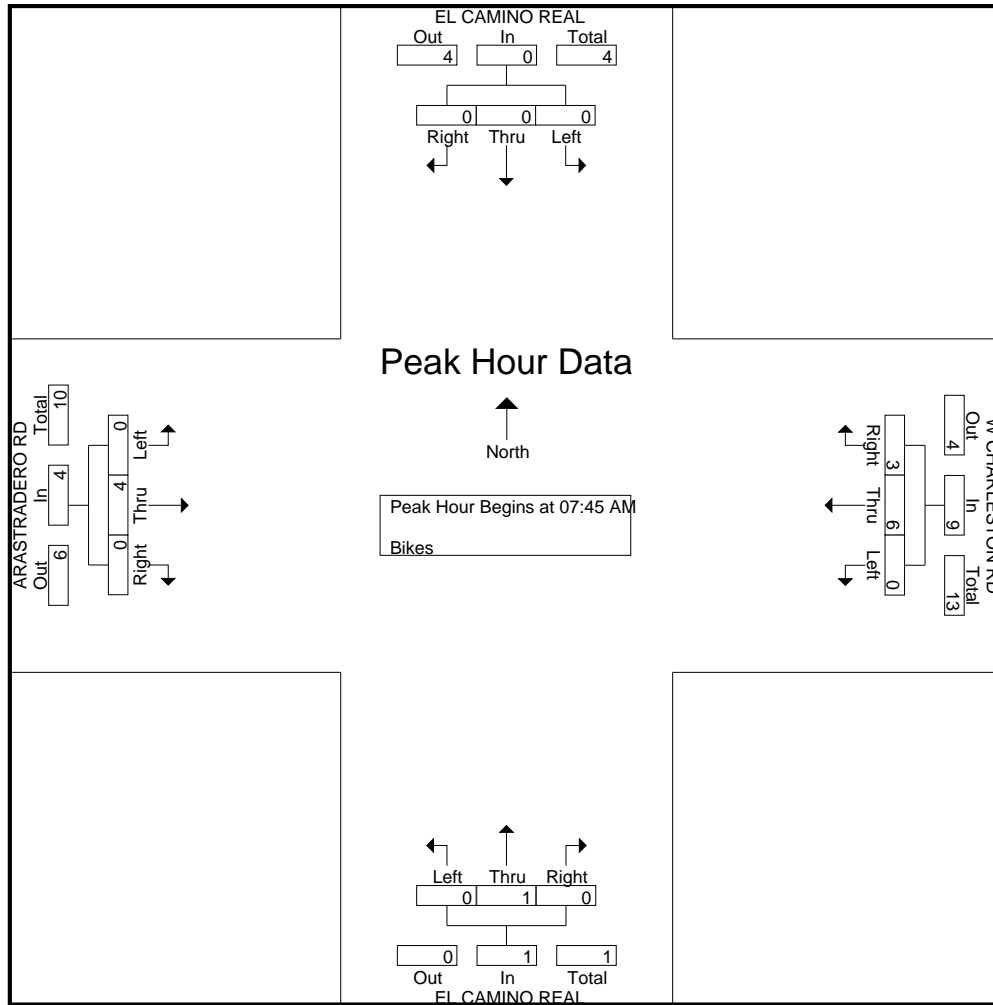

Traffic Data Service

San Jose, CA
 (408) 622-4787
 tdsbay@cs.com

File Name : 1PM FINAL
 Site Code : 00000001
 Start Date : 4/27/2021
 Page No : 1

Groups Printed- Lights - Buses - Trucks

Start Time	EL CAMINO REAL Southbound					W CHARLESTON RD Westbound					EL CAMINO REAL Northbound					ARASTRADERO RD Eastbound					Int. Total
	Right	Thru	Left	Peds	App. Total	Right	Thru	Left	Peds	App. Total	Right	Thru	Left	Peds	App. Total	Right	Thru	Left	Peds	App. Total	
04:00 PM	31	162	26	3	222	25	57	22	3	107	30	126	39	1	196	48	82	35	4	169	694
04:15 PM	19	162	29	2	212	24	35	23	3	85	22	129	38	0	189	78	89	21	3	191	677
04:30 PM	29	201	29	4	263	26	41	22	3	92	30	142	35	3	210	75	74	23	3	175	740
04:45 PM	22	157	32	6	217	20	46	33	4	103	25	132	53	1	211	70	77	23	2	172	703
Total	101	682	116	15	914	95	179	100	13	387	107	529	165	5	806	271	322	102	12	707	2814
05:00 PM	35	169	29	3	236	28	61	25	1	115	32	126	29	0	187	66	63	22	1	152	690
05:15 PM	23	168	27	5	223	32	44	16	2	94	27	132	47	3	209	67	69	21	5	162	688
05:30 PM	25	157	26	0	208	25	55	20	1	101	25	108	38	5	176	54	83	26	5	168	653
05:45 PM	16	127	29	2	174	31	47	31	5	114	26	90	29	5	150	42	47	32	1	122	560
Total	99	621	111	10	841	116	207	92	9	424	110	456	143	13	722	229	262	101	12	604	2591
Grand Total	200	1303	227	25	1755	211	386	192	22	811	217	985	308	18	1528	500	584	203	24	1311	5405
Apprch %	11.4	74.2	12.9	1.4		26	47.6	23.7	2.7		14.2	64.5	20.2	1.2		38.1	44.5	15.5	1.8		
Total %	3.7	24.1	4.2	0.5	32.5	3.9	7.1	3.6	0.4	15	4	18.2	5.7	0.3	28.3	9.3	10.8	3.8	0.4	24.3	
Lights	199	1284	226	25	1734	209	384	192	22	807	216	967	307	18	1508	499	576	203	24	1302	5351
% Lights	99.5	98.5	99.6	100	98.8	99.1	99.5	100	100	99.5	99.5	98.2	99.7	100	98.7	99.8	98.6	100	100	99.3	99
Buses	0	13	0	0	13	0	0	0	0	0	0	16	1	0	17	0	2	0	0	2	32
% Buses	0	1	0	0	0.7	0	0	0	0	0	0	1.6	0.3	0	1.1	0	0.3	0	0	0.2	0.6
Trucks	1	6	1	0	8	2	2	0	0	4	1	2	0	0	3	1	6	0	0	7	22
% Trucks	0.5	0.5	0.4	0	0.5	0.9	0.5	0	0	0.5	0.5	0.2	0	0	0.2	0.2	1	0	0	0.5	0.4

Start Time	EL CAMINO REAL Southbound				W CHARLESTON RD Westbound				EL CAMINO REAL Northbound				ARASTRADERO RD Eastbound				Int. Total
	Right	Thru	Left	App. Total	Right	Thru	Left	App. Total	Right	Thru	Left	App. Total	Right	Thru	Left	App. Total	
Peak Hour Analysis From 04:00 PM to 05:45 PM - Peak 1 of 1																	
Peak Hour for Entire Intersection Begins at 04:30 PM																	
04:30 PM	29	201	29	259	26	41	22	89	30	142	35	207	75	74	23	172	727
04:45 PM	22	157	32	211	20	46	33	99	25	132	53	210	70	77	23	170	690
05:00 PM	35	169	29	233	28	61	25	114	32	126	29	187	66	63	22	151	685
05:15 PM	23	168	27	218	32	44	16	92	27	132	47	206	67	69	21	157	673
Total Volume	109	695	117	921	106	192	96	394	114	532	164	810	278	283	89	650	2775
% App. Total	11.8	75.5	12.7		26.9	48.7	24.4		14.1	65.7	20.2		42.8	43.5	13.7		
PHF	.779	.864	.914	.889	.828	.787	.727	.864	.891	.937	.774	.964	.927	.919	.967	.945	.954

Traffic Data Service

San Jose, CA
 (408) 622-4787
 tdsbay@cs.com

File Name : 1PM FINAL
 Site Code : 00000001
 Start Date : 4/27/2021
 Page No : 2

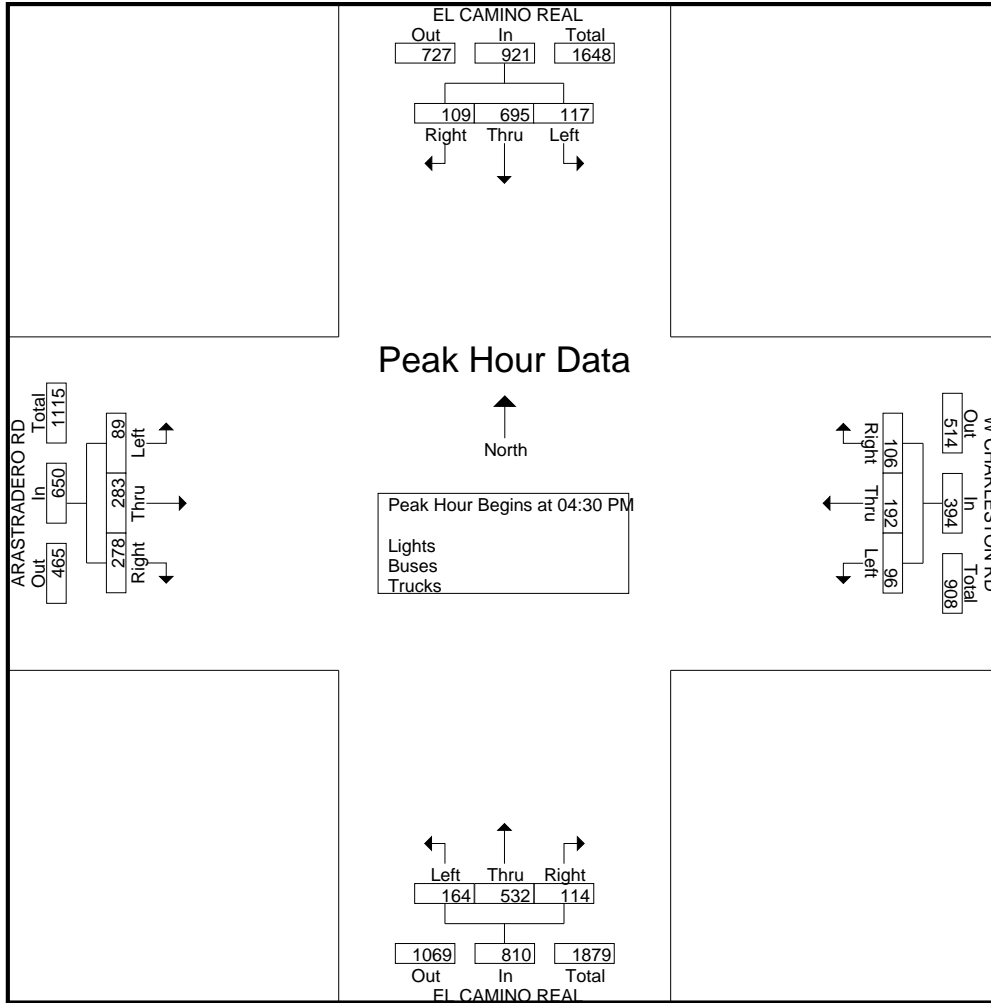

Traffic Data Service

San Jose, CA
 (408) 622-4787
 tdsbay@cs.com

File Name : 1PM FINAL
 Site Code : 00000001
 Start Date : 4/27/2021
 Page No : 1

Groups Printed- Bikes

Start Time	EL CAMINO REAL Southbound					W CHARLESTON RD Westbound					EL CAMINO REAL Northbound					ARASTRADERO RD Eastbound					Int. Total
	Right	Thru	Left	Peds	App. Total	Right	Thru	Left	Peds	App. Total	Right	Thru	Left	Peds	App. Total	Right	Thru	Left	Peds	App. Total	
04:00 PM	0	0	0	0	0	2	3	0	0	5	0	0	0	0	0	0	1	0	0	1	6
04:15 PM	0	0	0	0	0	0	0	0	0	0	0	0	0	0	0	0	5	0	0	5	5
04:30 PM	0	0	0	0	0	1	2	0	0	3	0	0	0	0	0	0	0	0	0	0	3
04:45 PM	0	0	0	0	0	1	2	0	0	3	0	0	0	0	0	0	1	0	0	1	4
Total	0	0	0	0	0	4	7	0	0	11	0	0	0	0	0	0	7	0	0	7	18
05:00 PM	0	0	0	0	0	0	2	0	0	2	0	0	0	0	0	0	4	0	0	4	6
05:15 PM	0	1	0	0	1	0	1	0	0	1	0	0	0	0	0	0	3	0	0	3	5
05:30 PM	0	1	0	0	1	0	5	0	0	5	0	0	0	0	0	0	2	0	0	2	8
05:45 PM	0	0	0	0	0	0	5	0	0	5	0	0	0	0	0	0	3	0	0	3	8
Total	0	2	0	0	2	0	13	0	0	13	0	0	0	0	0	0	12	0	0	12	27
Grand Total	0	2	0	0	2	4	20	0	0	24	0	0	0	0	0	0	19	0	0	19	45
Apprch %	0	100	0	0		16.7	83.3	0	0		0	0	0	0		0	100	0	0		
Total %	0	4.4	0	0	4.4	8.9	44.4	0	0	53.3	0	0	0	0	0	0	42.2	0	0	42.2	

Start Time	EL CAMINO REAL Southbound					W CHARLESTON RD Westbound					EL CAMINO REAL Northbound					ARASTRADERO RD Eastbound					Int. Total
	Right	Thru	Left	Peds	App. Total	Right	Thru	Left	Peds	App. Total	Right	Thru	Left	Peds	App. Total	Right	Thru	Left	Peds	App. Total	
05:00 PM	0	0	0	0	0	0	2	0	0	2	0	0	0	0	0	0	4	0	0	4	6
05:15 PM	0	1	0	0	1	0	1	0	0	1	0	0	0	0	0	0	3	0	0	3	5
05:30 PM	0	1	0	0	1	0	5	0	0	5	0	0	0	0	0	0	2	0	0	2	8
05:45 PM	0	0	0	0	0	0	5	0	0	5	0	0	0	0	0	0	3	0	0	3	8
Total Volume	0	2	0	0	2	0	13	0	0	13	0	0	0	0	0	0	12	0	0	12	27
% App. Total	0	100	0	0		0	100	0	0		0	0	0	0		0	100	0	0		
PHF	.000	.500	.000	.000	.500	.000	.650	.000	.000	.650	.000	.000	.000	.000	.000	.000	.750	.000	.000	.750	.844

Peak Hour Analysis From 04:00 PM to 05:45 PM - Peak 1 of 1
 Peak Hour for Entire Intersection Begins at 05:00 PM

Traffic Data Service

San Jose, CA
 (408) 622-4787
 tdsbay@cs.com

File Name : 1PM FINAL
 Site Code : 00000001
 Start Date : 4/27/2021
 Page No : 2

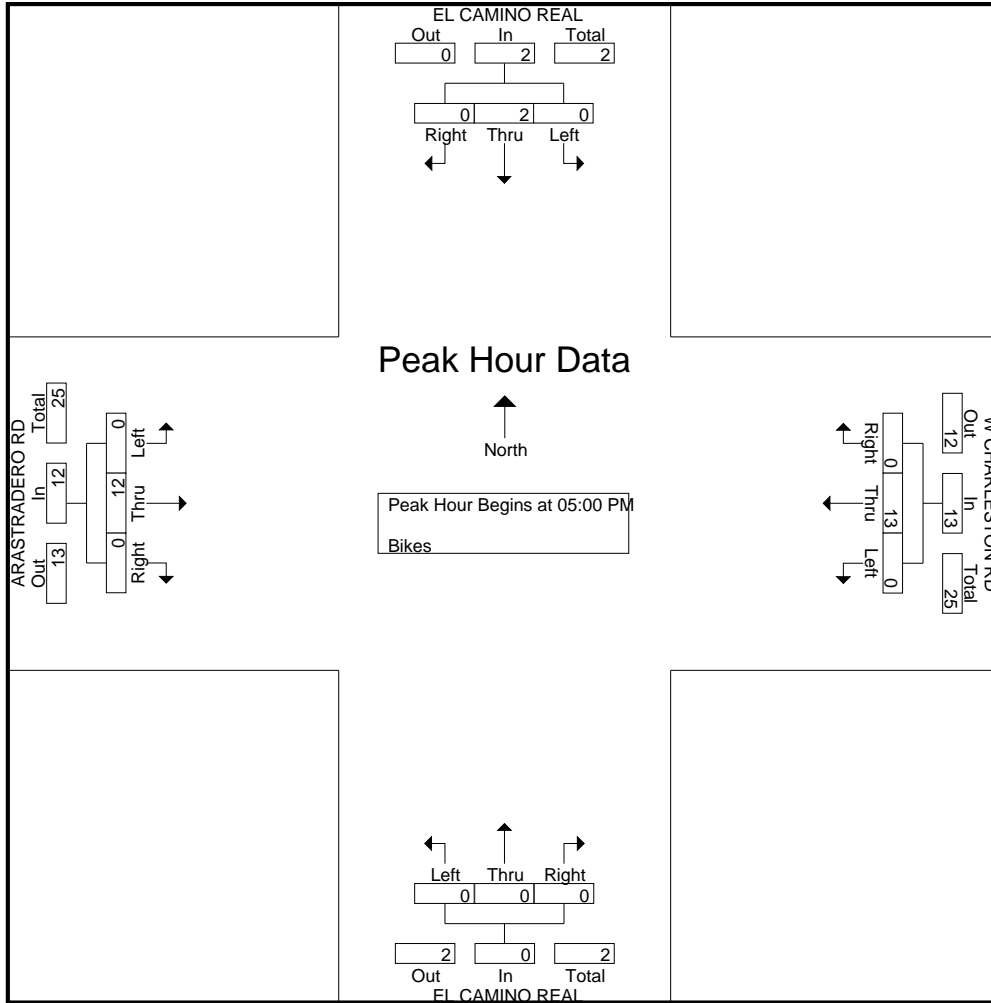

Traffic Data Service

San Jose, CA
 (408) 622-4787
 tdsbay@cs.com

File Name : 2AM FINAL
 Site Code : 00000002
 Start Date : 4/27/2021
 Page No : 1

Groups Printed- Lights - Buses - Trucks

Start Time	EL CAMINO REAL Southbound					DEL MEDIO AVE Westbound					EL CAMINO REAL Northbound					DRIVEWAY Eastbound					Int. Total
	Right	Thru	Left	Peds	App. Total	Right	Thru	Left	Peds	App. Total	Right	Thru	Left	Peds	App. Total	Right	Thru	Left	Peds	App. Total	
07:00 AM	0	41	6	5	52	11	0	7	0	18	6	105	3	0	114	0	0	0	4	4	188
07:15 AM	0	62	0	0	62	15	0	2	0	17	4	133	5	0	142	0	0	0	0	0	221
07:30 AM	0	77	7	1	85	28	0	5	0	33	5	126	4	0	135	0	0	0	2	2	255
07:45 AM	0	89	8	1	98	25	0	3	3	31	7	140	13	0	160	0	0	0	1	1	290
Total	0	269	21	7	297	79	0	17	3	99	22	504	25	0	551	0	0	0	7	7	954
08:00 AM	0	87	4	4	95	32	0	8	3	43	9	154	10	0	173	0	0	0	2	2	313
08:15 AM	0	120	26	4	150	33	0	9	4	46	16	135	7	0	158	0	0	0	3	3	357
08:30 AM	0	104	27	2	133	17	0	5	3	25	17	178	6	0	201	0	0	0	2	2	361
08:45 AM	0	103	9	1	113	19	0	10	2	31	24	166	11	0	201	0	0	0	1	1	346
Total	0	414	66	11	491	101	0	32	12	145	66	633	34	0	733	0	0	0	8	8	1377
Grand Total	0	683	87	18	788	180	0	49	15	244	88	1137	59	0	1284	0	0	0	15	15	2331
Apprch %	0	86.7	11	2.3		73.8	0	20.1	6.1		6.9	88.6	4.6	0		0	0	0	100		
Total %	0	29.3	3.7	0.8	33.8	7.7	0	2.1	0.6	10.5	3.8	48.8	2.5	0	55.1	0	0	0	0.6	0.6	
Lights	0	640	87	18	745	168	0	47	15	230	84	1090	59	0	1233	0	0	0	15	15	2223
% Lights	0	93.7	100	100	94.5	93.3	0	95.9	100	94.3	95.5	95.9	100	0	96	0	0	0	100	100	95.4
Buses	0	19	0	0	19	0	0	1	0	1	1	15	0	0	16	0	0	0	0	0	36
% Buses	0	2.8	0	0	2.4	0	0	2	0	0.4	1.1	1.3	0	0	1.2	0	0	0	0	0	1.5
Trucks	0	24	0	0	24	12	0	1	0	13	3	32	0	0	35	0	0	0	0	0	72
% Trucks	0	3.5	0	0	3	6.7	0	2	0	5.3	3.4	2.8	0	0	2.7	0	0	0	0	0	3.1

Start Time	EL CAMINO REAL Southbound				DEL MEDIO AVE Westbound				EL CAMINO REAL Northbound				DRIVEWAY Eastbound				Int. Total
	Right	Thru	Left	App. Total	Right	Thru	Left	App. Total	Right	Thru	Left	App. Total	Right	Thru	Left	App. Total	
Peak Hour Analysis From 07:00 AM to 08:45 AM - Peak 1 of 1																	
Peak Hour for Entire Intersection Begins at 08:00 AM																	
08:00 AM	0	87	4	91	32	0	8	40	9	154	10	173	0	0	0	0	304
08:15 AM	0	120	26	146	33	0	9	42	16	135	7	158	0	0	0	0	346
08:30 AM	0	104	27	131	17	0	5	22	17	178	6	201	0	0	0	0	354
08:45 AM	0	103	9	112	19	0	10	29	24	166	11	201	0	0	0	0	342
Total Volume	0	414	66	480	101	0	32	133	66	633	34	733	0	0	0	0	1346
% App. Total	0	86.2	13.8		75.9	0	24.1		9	86.4	4.6		0	0	0		
PHF	.000	.863	.611	.822	.765	.000	.800	.792	.688	.889	.773	.912	.000	.000	.000	.000	.951

Traffic Data Service

San Jose, CA
 (408) 622-4787
 tdsbay@cs.com

File Name : 2AM FINAL
 Site Code : 00000002
 Start Date : 4/27/2021
 Page No : 2

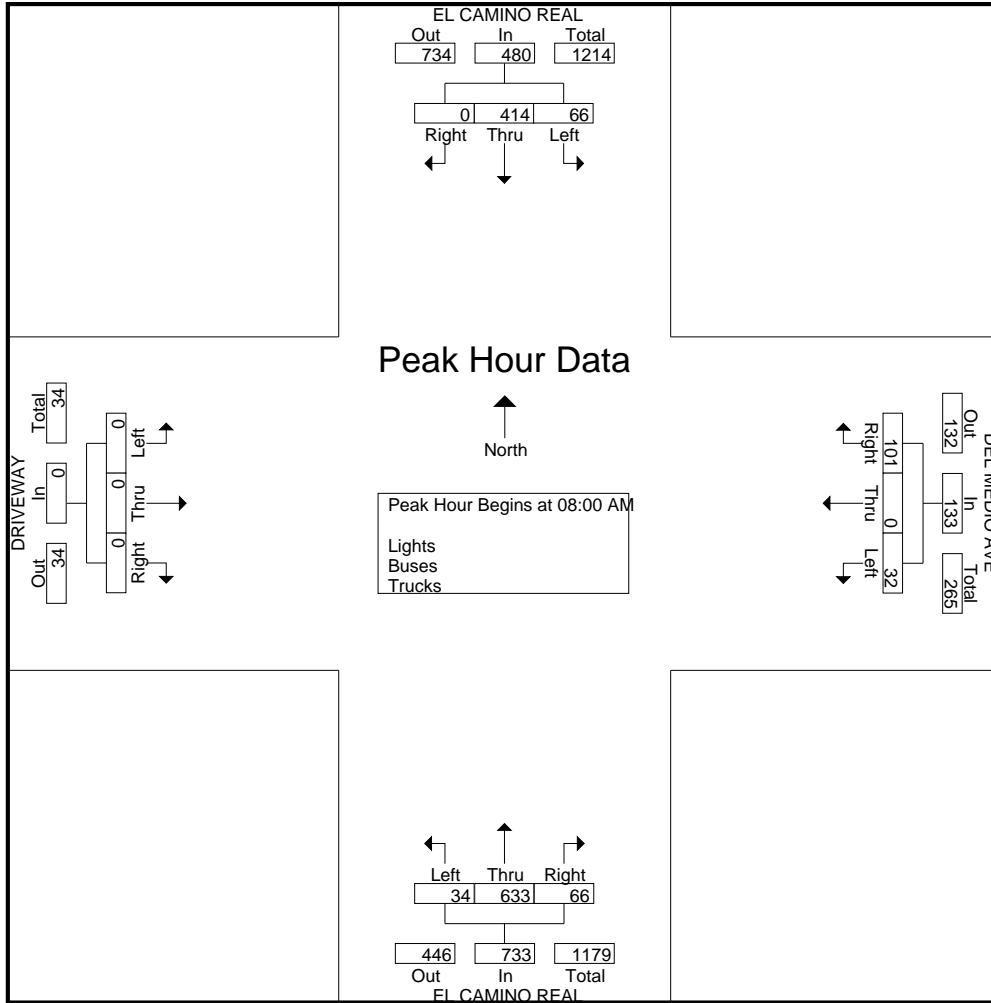

Traffic Data Service

San Jose, CA
 (408) 622-4787
 tdsbay@cs.com

File Name : 2AM FINAL
 Site Code : 00000002
 Start Date : 4/27/2021
 Page No : 1

Groups Printed- Bikes

Start Time	EL CAMINO REAL Southbound					DEL MEDIO AVE Westbound					EL CAMINO REAL Northbound					DRIVEWAY Eastbound					Int. Total
	Right	Thru	Left	Peds	App. Total	Right	Thru	Left	Peds	App. Total	Right	Thru	Left	Peds	App. Total	Right	Thru	Left	Peds	App. Total	
07:00 AM	0	0	0	0	0	0	0	0	0	0	0	0	0	0	0	0	0	0	0	0	0
07:15 AM	0	0	1	0	1	0	0	0	0	0	0	0	0	0	0	0	0	0	0	0	0
07:30 AM	0	0	0	0	0	0	0	0	0	0	0	0	0	0	0	0	0	0	0	0	0
07:45 AM	0	1	0	0	1	0	0	0	0	0	0	2	1	0	3	0	0	0	0	0	0
Total	0	1	1	0	2	0	0	0	0	0	0	2	1	0	3	0	0	0	0	0	0
08:00 AM	1	0	0	0	1	0	0	0	0	0	0	2	0	0	2	0	1	0	0	1	4
08:15 AM	0	0	0	0	0	0	0	0	0	0	0	0	0	0	0	0	0	0	0	0	0
08:30 AM	0	0	0	0	0	0	0	0	0	0	1	0	0	0	1	0	0	0	0	0	1
08:45 AM	0	0	0	0	0	0	0	0	0	0	0	0	0	0	0	0	0	0	0	0	0
Total	1	0	0	0	1	0	0	0	0	0	1	2	0	0	3	0	1	0	0	1	5
Grand Total	1	1	1	0	3	0	0	0	0	0	1	4	1	0	6	0	1	0	0	1	10
Apprch %	33.3	33.3	33.3	0		0	0	0	0		16.7	66.7	16.7	0		0	100	0	0		
Total %	10	10	10	0	30	0	0	0	0	0	10	40	10	0	60	0	10	0	0	10	

Start Time	EL CAMINO REAL Southbound				DEL MEDIO AVE Westbound				EL CAMINO REAL Northbound				DRIVEWAY Eastbound				Int. Total
	Right	Thru	Left	App. Total	Right	Thru	Left	App. Total	Right	Thru	Left	App. Total	Right	Thru	Left	App. Total	
Peak Hour Analysis From 07:00 AM to 08:45 AM - Peak 1 of 1																	
Peak Hour for Entire Intersection Begins at 07:15 AM																	
07:15 AM	0	0	1	1	0	0	0	0	0	0	0	0	0	0	0	0	0
07:30 AM	0	0	0	0	0	0	0	0	0	0	0	0	0	0	0	0	0
07:45 AM	0	1	0	1	0	0	0	0	0	2	1	3	0	0	0	0	4
08:00 AM	1	0	0	1	0	0	0	0	0	2	0	2	0	1	0	1	4
Total Volume	1	1	1	3	0	0	0	0	0	4	1	5	0	1	0	1	9
% App. Total	33.3	33.3	33.3		0	0	0		0	80	20		0	100	0		
PHF	.250	.250	.250	.750	.000	.000	.000	.000	.000	.500	.250	.417	.000	.250	.000	.250	.563

Traffic Data Service

San Jose, CA
 (408) 622-4787
 tdsbay@cs.com

File Name : 2AM FINAL
 Site Code : 00000002
 Start Date : 4/27/2021
 Page No : 2

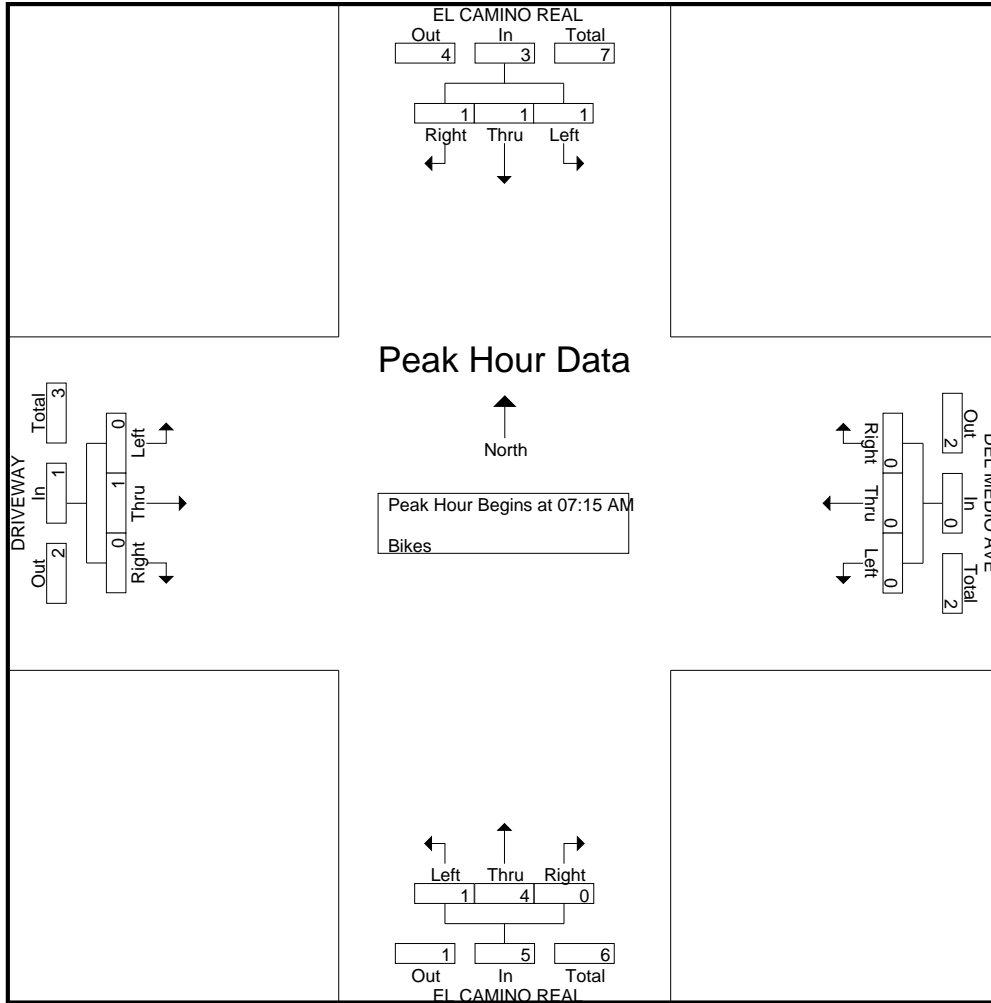

Traffic Data Service

San Jose, CA
 (408) 622-4787
 tdsbay@cs.com

File Name : 2PM FINAL
 Site Code : 00000002
 Start Date : 4/27/2021
 Page No : 1

Groups Printed- Lights - Buses - Trucks

Start Time	EL CAMINO REAL Southbound					DEL MEDIO AVE Westbound					EL CAMINO REAL Northbound					DRIVEWAY Eastbound					Int. Total
	Right	Thru	Left	Peds	App. Total	Right	Thru	Left	Peds	App. Total	Right	Thru	Left	Peds	App. Total	Right	Thru	Left	Peds	App. Total	
04:00 PM	1	232	12	0	245	15	0	9	0	24	20	167	18	0	205	0	0	0	2	2	476
04:15 PM	0	242	17	3	262	13	0	2	5	20	18	171	11	0	200	0	0	0	3	3	485
04:30 PM	1	264	20	0	285	15	0	7	1	23	21	169	16	0	206	0	1	0	2	3	517
04:45 PM	0	215	16	3	234	14	0	9	0	23	16	166	18	0	200	0	0	0	4	4	461
Total	2	953	65	6	1026	57	0	27	6	90	75	673	63	0	811	0	1	0	11	12	1939
05:00 PM	0	261	15	1	277	15	0	10	2	27	25	180	10	0	215	0	0	0	1	1	520
05:15 PM	0	214	12	2	228	13	0	11	4	28	21	152	12	0	185	0	0	1	0	1	442
05:30 PM	0	184	14	4	202	15	0	10	5	30	20	138	15	0	173	0	0	0	2	2	407
05:45 PM	0	168	11	1	180	12	0	7	3	22	13	148	12	0	173	2	0	0	0	2	377
Total	0	827	52	8	887	55	0	38	14	107	79	618	49	0	746	2	0	1	3	6	1746
Grand Total	2	1780	117	14	1913	112	0	65	20	197	154	1291	112	0	1557	2	1	1	14	18	3685
Apprch %	0.1	93	6.1	0.7		56.9	0	33	10.2		9.9	82.9	7.2	0		11.1	5.6	5.6	77.8		
Total %	0.1	48.3	3.2	0.4	51.9	3	0	1.8	0.5	5.3	4.2	35	3	0	42.3	0.1	0	0	0.4	0.5	
Lights	2	1759	117	14	1892	111	0	65	20	196	152	1271	111	0	1534	2	1	1	14	18	3640
% Lights	100	98.8	100	100	98.9	99.1	0	100	100	99.5	98.7	98.5	99.1	0	98.5	100	100	100	100	100	98.8
Buses	0	14	0	0	14	0	0	0	0	0	0	17	0	0	17	0	0	0	0	0	31
% Buses	0	0.8	0	0	0.7	0	0	0	0	0	0	1.3	0	0	1.1	0	0	0	0	0	0.8
Trucks	0	7	0	0	7	1	0	0	0	1	2	3	1	0	6	0	0	0	0	0	14
% Trucks	0	0.4	0	0	0.4	0.9	0	0	0	0.5	1.3	0.2	0.9	0	0.4	0	0	0	0	0	0.4

Start Time	EL CAMINO REAL Southbound				DEL MEDIO AVE Westbound				EL CAMINO REAL Northbound				DRIVEWAY Eastbound				Int. Total
	Right	Thru	Left	App. Total	Right	Thru	Left	App. Total	Right	Thru	Left	App. Total	Right	Thru	Left	App. Total	
Peak Hour Analysis From 04:00 PM to 05:45 PM - Peak 1 of 1																	
Peak Hour for Entire Intersection Begins at 04:15 PM																	
04:15 PM	0	242	17	259	13	0	2	15	18	171	11	200	0	0	0	0	474
04:30 PM	1	264	20	285	15	0	7	22	21	169	16	206	0	1	0	1	514
04:45 PM	0	215	16	231	14	0	9	23	16	166	18	200	0	0	0	0	454
05:00 PM	0	261	15	276	15	0	10	25	25	180	10	215	0	0	0	0	516
Total Volume	1	982	68	1051	57	0	28	85	80	686	55	821	0	1	0	1	1958
% App. Total	0.1	93.4	6.5		67.1	0	32.9		9.7	83.6	6.7		0	100	0		
PHF	.250	.930	.850	.922	.950	.000	.700	.850	.800	.953	.764	.955	.000	.250	.000	.250	.949

Traffic Data Service

San Jose, CA
 (408) 622-4787
 tdsbay@cs.com

File Name : 2PM FINAL
 Site Code : 00000002
 Start Date : 4/27/2021
 Page No : 2

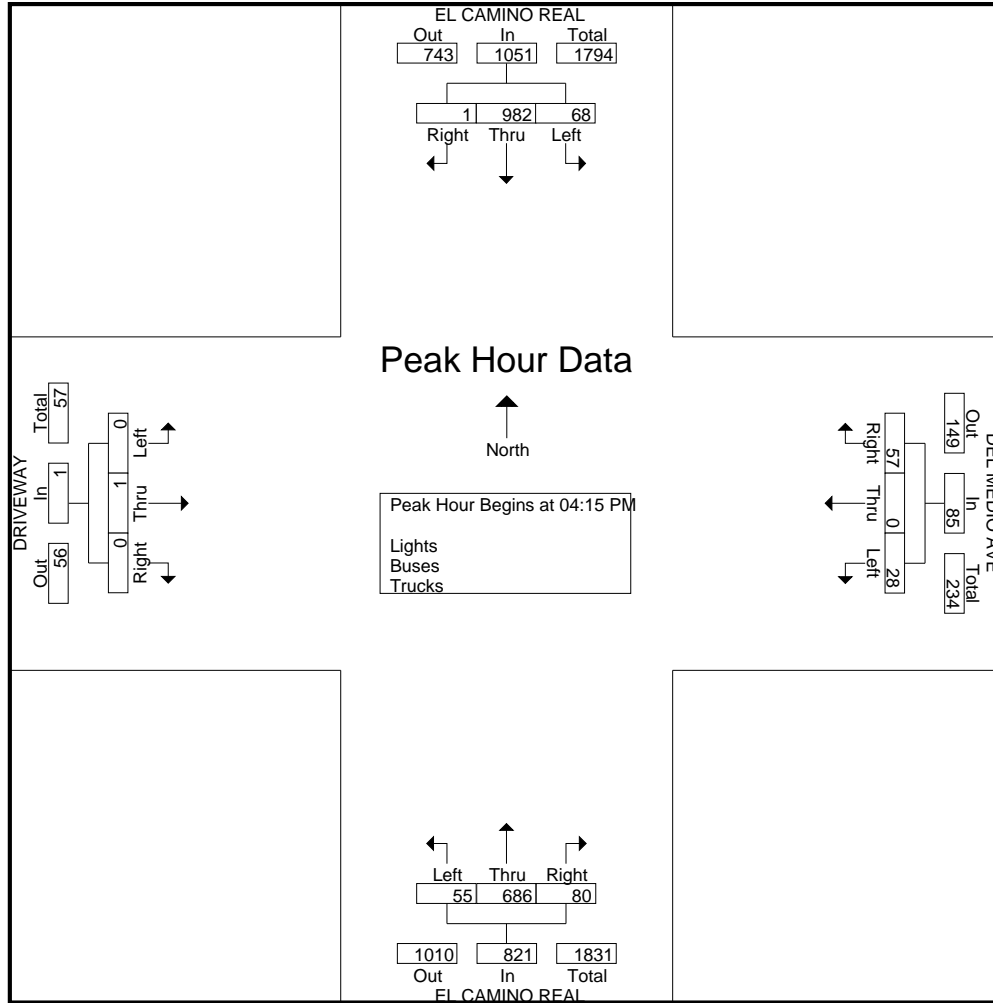

Traffic Data Service

San Jose, CA
 (408) 622-4787
 tdsbay@cs.com

File Name : 2PM FINAL
 Site Code : 00000002
 Start Date : 4/27/2021
 Page No : 1

Groups Printed- Bikes

Start Time	EL CAMINO REAL Southbound					DEL MEDIO AVE Westbound					EL CAMINO REAL Northbound					DRIVEWAY Eastbound					Int. Total
	Right	Thru	Left	Peds	App. Total	Right	Thru	Left	Peds	App. Total	Right	Thru	Left	Peds	App. Total	Right	Thru	Left	Peds	App. Total	
04:00 PM	0	0	0	0	0	0	0	0	0	0	0	0	0	0	0	0	0	0	0	0	0
04:15 PM	0	0	1	0	1	0	0	0	0	0	0	0	0	0	0	0	0	0	0	0	0
04:30 PM	0	0	1	0	1	0	0	0	0	0	0	0	0	0	0	0	0	0	0	0	0
04:45 PM	0	0	0	0	0	0	0	0	0	0	0	0	0	0	0	0	0	0	0	0	0
Total	0	0	2	0	2	0	0	0	0	0	0	0	0	0	0	0	0	0	0	0	2
05:00 PM	0	0	0	0	0	0	0	0	0	0	0	0	0	0	0	0	0	0	0	0	0
05:15 PM	0	0	1	0	1	0	1	0	0	1	0	0	0	0	0	0	0	0	0	0	2
05:30 PM	0	0	0	0	0	0	0	0	0	0	0	0	0	0	0	0	0	0	0	0	0
05:45 PM	0	0	0	0	0	0	0	0	0	0	0	0	0	0	0	0	0	0	0	0	0
Total	0	0	1	0	1	0	1	0	0	1	0	0	0	0	0	0	0	0	0	0	2
Grand Total	0	0	3	0	3	0	1	0	0	1	0	0	0	0	0	0	0	0	0	0	4
Apprch %	0	0	100	0		0	100	0	0		0	0	0	0		0	0	0	0		
Total %	0	0	75	0	75	0	25	0	0	25	0	0	0	0	0	0	0	0	0	0	

Start Time	EL CAMINO REAL Southbound				DEL MEDIO AVE Westbound				EL CAMINO REAL Northbound				DRIVEWAY Eastbound				Int. Total
	Right	Thru	Left	App. Total	Right	Thru	Left	App. Total	Right	Thru	Left	App. Total	Right	Thru	Left	App. Total	
Peak Hour Analysis From 04:00 PM to 05:45 PM - Peak 1 of 1																	
Peak Hour for Entire Intersection Begins at 04:30 PM																	
04:30 PM	0	0	1	1	0	0	0	0	0	0	0	0	0	0	0	0	1
04:45 PM	0	0	0	0	0	0	0	0	0	0	0	0	0	0	0	0	0
05:00 PM	0	0	0	0	0	0	0	0	0	0	0	0	0	0	0	0	0
05:15 PM	0	0	1	1	0	1	0	1	0	0	0	0	0	0	0	0	2
Total Volume	0	0	2	2	0	1	0	1	0	0	0	0	0	0	0	0	3
% App. Total	0	0	100		0	100	0		0	0	0		0	0	0		
PHF	.000	.000	.500	.500	.000	.250	.000	.250	.000	.000	.000	.000	.000	.000	.000	.000	.375

Traffic Data Service

San Jose, CA
 (408) 622-4787
 tdsbay@cs.com

File Name : 2PM FINAL
 Site Code : 00000002
 Start Date : 4/27/2021
 Page No : 2

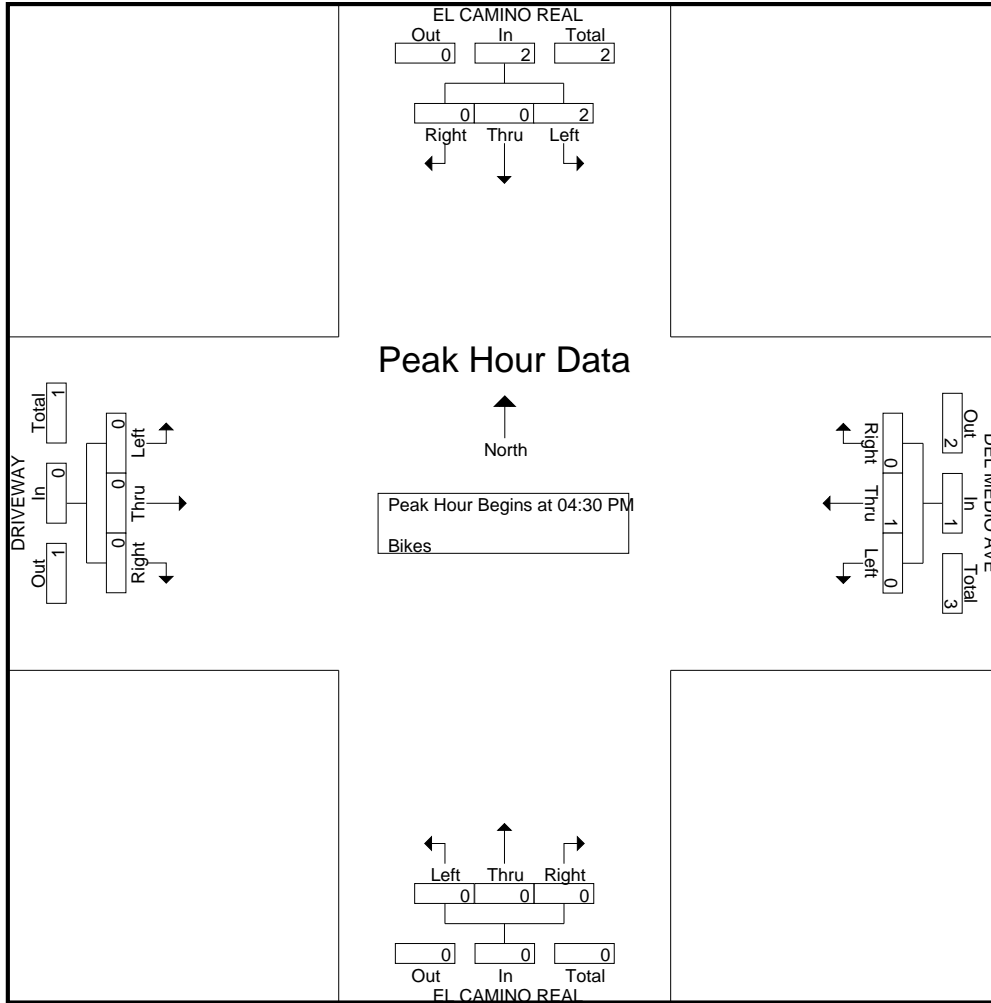

Traffic Data Service

San Jose, CA
(408) 622-4787
tdsbay@cs.com

File Name : 3AM FINAL
 Site Code : 00000003
 Start Date : 4/27/2021
 Page No : 1

Groups Printed- Lights - Buses - Trucks

Start Time	EL CAMINO REAL Southbound					SAN ANTONIO RD Westbound					EL CAMINO REAL Northbound					SAN ANTONIO RD Eastbound					Int. Total
	Right	Thru	Left	Peds	App. Total	Right	Thru	Left	Peds	App. Total	Right	Thru	Left	Peds	App. Total	Right	Thru	Left	Peds	App. Total	
07:00 AM	6	28	16	5	55	23	50	17	0	90	9	84	26	0	119	2	22	6	1	31	295
07:15 AM	9	45	15	1	70	11	60	19	0	90	12	113	27	0	152	6	38	12	0	56	368
07:30 AM	11	42	30	3	86	16	82	39	0	137	14	99	41	3	157	6	50	9	3	68	448
07:45 AM	10	57	31	7	105	22	114	32	5	173	19	121	37	3	180	6	63	16	0	85	543
Total	36	172	92	16	316	72	306	107	5	490	54	417	131	6	608	20	173	43	4	240	1654
08:00 AM	18	73	45	6	142	22	116	40	9	187	21	119	46	2	188	5	84	27	1	117	634
08:15 AM	16	86	30	1	133	21	115	26	0	162	35	119	47	4	205	19	108	27	1	155	655
08:30 AM	21	82	23	2	128	23	62	34	3	122	25	147	46	1	219	8	75	30	0	113	582
08:45 AM	26	82	33	2	143	25	74	34	6	139	27	141	60	3	231	6	76	24	1	107	620
Total	81	323	131	11	546	91	367	134	18	610	108	526	199	10	843	38	343	108	3	492	2491
Grand Total	117	495	223	27	862	163	673	241	23	1100	162	943	330	16	1451	58	516	151	7	732	4145
Apprch %	13.6	57.4	25.9	3.1		14.8	61.2	21.9	2.1		11.2	65	22.7	1.1		7.9	70.5	20.6	1		
Total %	2.8	11.9	5.4	0.7	20.8	3.9	16.2	5.8	0.6	26.5	3.9	22.8	8	0.4	35	1.4	12.4	3.6	0.2	17.7	
Lights	115	468	217	27	827	148	659	225	23	1055	150	916	314	16	1396	54	506	146	7	713	3991
% Lights	98.3	94.5	97.3	100	95.9	90.8	97.9	93.4	100	95.9	92.6	97.1	95.2	100	96.2	93.1	98.1	96.7	100	97.4	96.3
Buses	0	12	0	0	12	0	2	1	0	3	7	15	4	0	26	2	0	0	0	2	43
% Buses	0	2.4	0	0	1.4	0	0.3	0.4	0	0.3	4.3	1.6	1.2	0	1.8	3.4	0	0	0	0.3	1
Trucks	2	15	6	0	23	15	12	15	0	42	5	12	12	0	29	2	10	5	0	17	111
% Trucks	1.7	3	2.7	0	2.7	9.2	1.8	6.2	0	3.8	3.1	1.3	3.6	0	2	3.4	1.9	3.3	0	2.3	2.7

Start Time	EL CAMINO REAL Southbound				SAN ANTONIO RD Westbound				EL CAMINO REAL Northbound				SAN ANTONIO RD Eastbound				Int. Total
	Right	Thru	Left	App. Total	Right	Thru	Left	App. Total	Right	Thru	Left	App. Total	Right	Thru	Left	App. Total	
Peak Hour Analysis From 07:00 AM to 08:45 AM - Peak 1 of 1																	
Peak Hour for Entire Intersection Begins at 08:00 AM																	
08:00 AM	18	73	45	136	22	116	40	178	21	119	46	186	5	84	27	116	616
08:15 AM	16	86	30	132	21	115	26	162	35	119	47	201	19	108	27	154	649
08:30 AM	21	82	23	126	23	62	34	119	25	147	46	218	8	75	30	113	576
08:45 AM	26	82	33	141	25	74	34	133	27	141	60	228	6	76	24	106	608
Total Volume	81	323	131	535	91	367	134	592	108	526	199	833	38	343	108	489	2449
% App. Total	15.1	60.4	24.5		15.4	62	22.6		13	63.1	23.9		7.8	70.1	22.1		
PHF	.779	.939	.728	.949	.910	.791	.838	.831	.771	.895	.829	.913	.500	.794	.900	.794	.943

Traffic Data Service

San Jose, CA
 (408) 622-4787
 tdsbay@cs.com

File Name : 3AM FINAL
 Site Code : 00000003
 Start Date : 4/27/2021
 Page No : 2

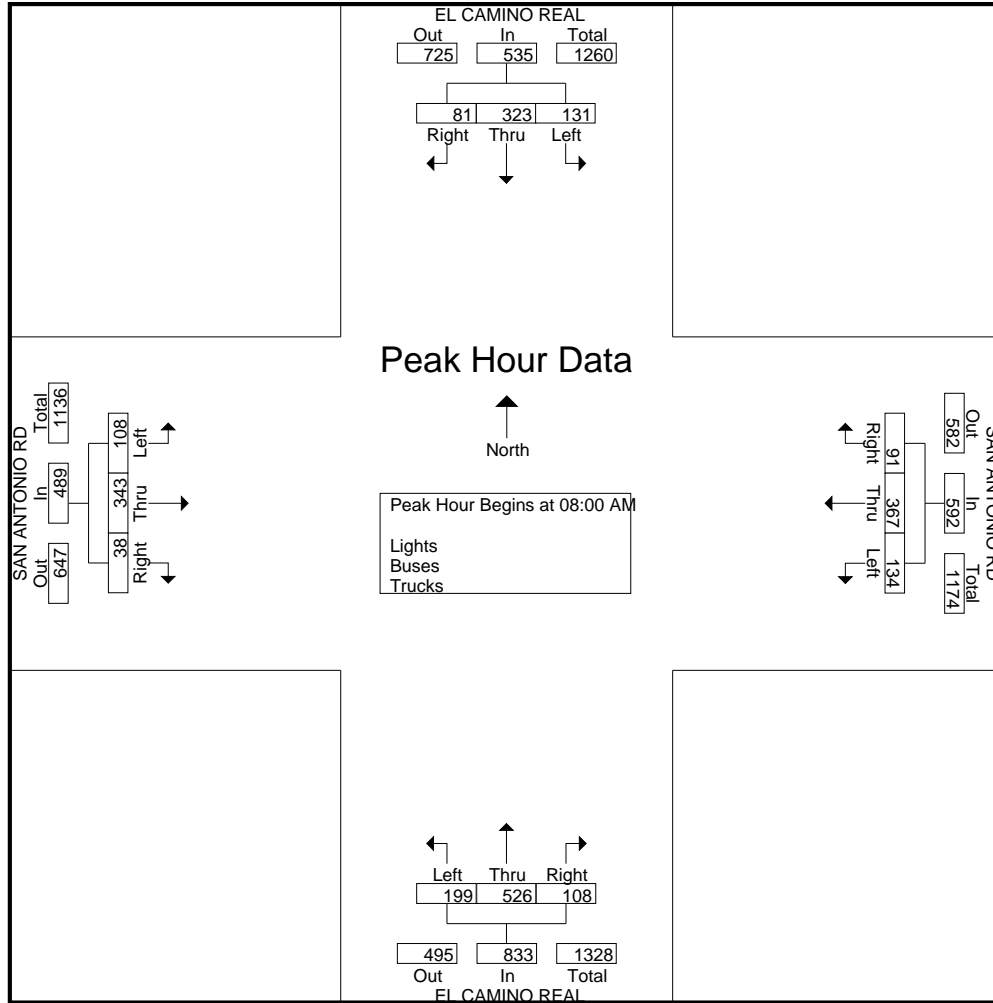

Traffic Data Service

San Jose, CA
 (408) 622-4787
 tdsbay@cs.com

File Name : 3AM FINAL
 Site Code : 00000003
 Start Date : 4/27/2021
 Page No : 1

Groups Printed- Bikes

Start Time	EL CAMINO REAL Southbound					SAN ANTONIO RD Westbound					EL CAMINO REAL Northbound					SAN ANTONIO RD Eastbound					Int. Total
	Right	Thru	Left	Peds	App. Total	Right	Thru	Left	Peds	App. Total	Right	Thru	Left	Peds	App. Total	Right	Thru	Left	Peds	App. Total	
07:00 AM	0	0	0	0	0	0	1	0	0	1	0	0	0	0	0	0	0	0	0	0	0
07:15 AM	0	0	0	0	0	0	0	0	0	0	0	0	0	0	0	0	0	0	0	0	0
07:30 AM	0	0	0	0	0	0	1	0	0	1	0	1	0	0	1	0	1	0	0	1	3
07:45 AM	0	0	0	0	0	0	0	0	0	0	0	0	0	0	0	0	1	0	0	1	1
Total	0	0	0	0	0	0	2	0	0	2	0	1	0	0	1	0	2	0	0	2	5
08:00 AM	1	0	0	0	1	0	0	0	0	0	0	0	0	0	0	0	0	0	0	0	1
08:15 AM	0	0	0	0	0	0	2	0	0	2	0	0	0	0	0	0	1	0	0	1	3
08:30 AM	0	0	0	0	0	0	0	0	0	0	0	0	1	0	1	0	2	0	0	2	3
08:45 AM	0	0	0	0	0	0	1	0	0	1	0	0	0	0	0	0	1	0	0	1	2
Total	1	0	0	0	1	0	3	0	0	3	0	0	1	0	1	0	4	0	0	4	9
Grand Total	1	0	0	0	1	0	5	0	0	5	0	1	1	0	2	0	6	0	0	6	14
Apprch %	100	0	0	0		0	100	0	0		0	50	50	0		0	100	0	0		
Total %	7.1	0	0	0	7.1	0	35.7	0	0	35.7	0	7.1	7.1	0	14.3	0	42.9	0	0	42.9	

Start Time	EL CAMINO REAL Southbound				SAN ANTONIO RD Westbound				EL CAMINO REAL Northbound				SAN ANTONIO RD Eastbound				Int. Total
	Right	Thru	Left	App. Total	Right	Thru	Left	App. Total	Right	Thru	Left	App. Total	Right	Thru	Left	App. Total	
08:00 AM	1	0	0	1	0	0	0	0	0	0	0	0	0	0	0	0	0
08:15 AM	0	0	0	0	0	2	0	2	0	0	0	0	0	1	0	1	3
08:30 AM	0	0	0	0	0	0	0	0	0	0	1	1	0	2	0	2	3
08:45 AM	0	0	0	0	0	1	0	1	0	0	0	0	0	1	0	1	2
Total Volume	1	0	0	1	0	3	0	3	0	0	1	1	0	4	0	4	9
% App. Total	100	0	0		0	100	0		0	0	100		0	100	0		
PHF	.250	.000	.000	.250	.000	.375	.000	.375	.000	.000	.250	.250	.000	.500	.000	.500	.750

Peak Hour Analysis From 07:00 AM to 08:45 AM - Peak 1 of 1
 Peak Hour for Entire Intersection Begins at 08:00 AM

Traffic Data Service

San Jose, CA
 (408) 622-4787
 tdsbay@cs.com

File Name : 3AM FINAL
 Site Code : 00000003
 Start Date : 4/27/2021
 Page No : 2

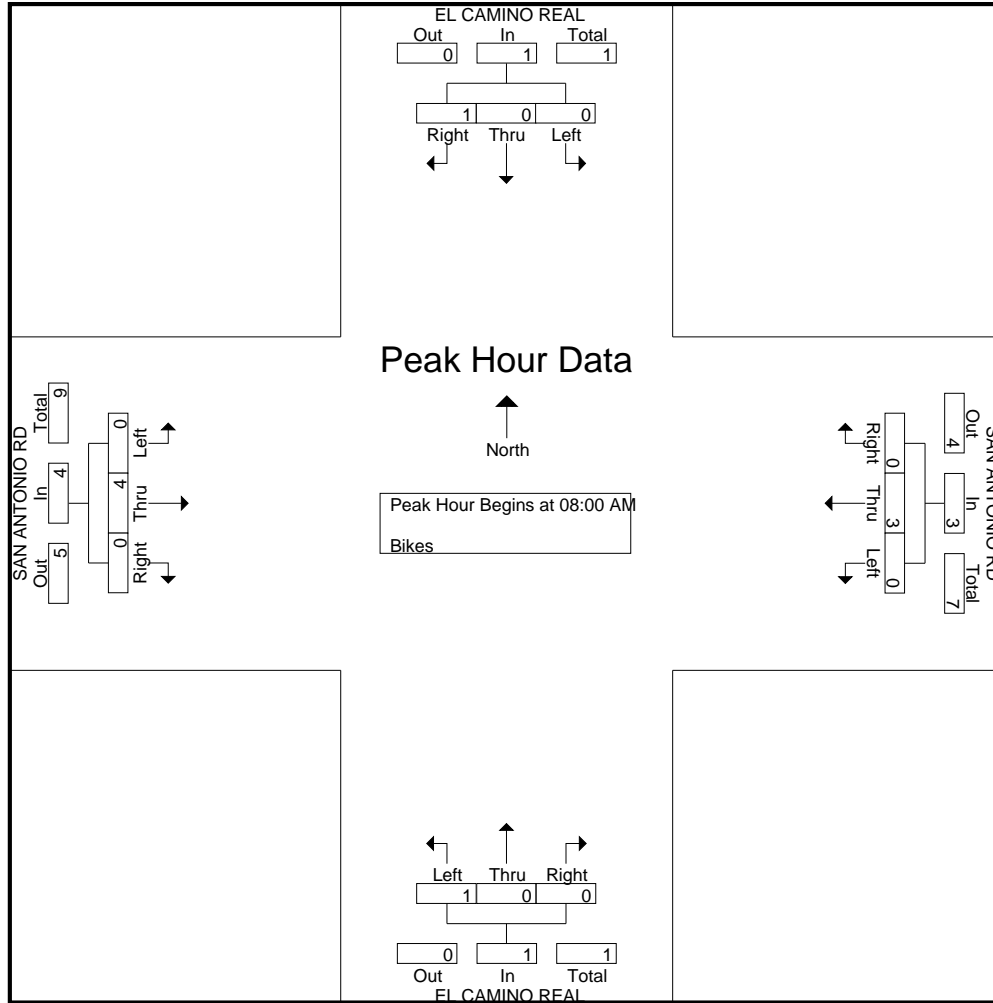

Traffic Data Service

San Jose, CA
 (408) 622-4787
 tdsbay@cs.com

File Name : 3PM FINAL
 Site Code : 00000003
 Start Date : 4/27/2021
 Page No : 1

Groups Printed- Lights - Buses - Trucks

Start Time	EL CAMINO REAL Southbound					SAN ANTONIO RD Westbound					EL CAMINO REAL Northbound					SAN ANTONIO RD Eastbound					Int. Total
	Right	Thru	Left	Peds	App. Total	Right	Thru	Left	Peds	App. Total	Right	Thru	Left	Peds	App. Total	Right	Thru	Left	Peds	App. Total	
04:00 PM	36	149	70	5	260	16	103	55	7	181	31	139	54	4	228	15	89	29	3	136	805
04:15 PM	26	163	60	8	257	27	88	39	8	162	30	145	50	3	228	12	84	31	2	129	776
04:30 PM	31	185	76	6	298	30	116	42	3	191	32	137	59	8	236	10	106	28	6	150	875
04:45 PM	21	169	55	6	251	29	72	55	3	159	32	135	36	5	208	14	87	22	1	124	742
Total	114	666	261	25	1066	102	379	191	21	693	125	556	199	20	900	51	366	110	12	539	3198
05:00 PM	39	181	56	2	278	25	93	71	2	191	41	146	67	4	258	9	119	33	4	165	892
05:15 PM	31	175	66	13	285	16	88	51	6	161	29	138	80	3	250	20	102	25	3	150	846
05:30 PM	38	140	59	1	238	15	88	37	3	143	35	115	60	3	213	17	101	25	1	144	738
05:45 PM	28	136	42	6	212	25	91	63	1	180	26	119	58	4	207	17	82	28	1	128	727
Total	136	632	223	22	1013	81	360	222	12	675	131	518	265	14	928	63	404	111	9	587	3203
Grand Total	250	1298	484	47	2079	183	739	413	33	1368	256	1074	464	34	1828	114	770	221	21	1126	6401
Apprch %	12	62.4	23.3	2.3		13.4	54	30.2	2.4		14	58.8	25.4	1.9		10.1	68.4	19.6	1.9		
Total %	3.9	20.3	7.6	0.7	32.5	2.9	11.5	6.5	0.5	21.4	4	16.8	7.2	0.5	28.6	1.8	12	3.5	0.3	17.6	
Lights	250	1277	481	47	2055	183	737	411	33	1364	243	1053	460	34	1790	107	766	218	21	1112	6321
% Lights	100	98.4	99.4	100	98.8	100	99.7	99.5	100	99.7	94.9	98	99.1	100	97.9	93.9	99.5	98.6	100	98.8	98.8
Buses	0	15	0	0	15	0	1	0	0	1	8	17	4	0	29	5	1	0	0	6	51
% Buses	0	1.2	0	0	0.7	0	0.1	0	0	0.1	3.1	1.6	0.9	0	1.6	4.4	0.1	0	0	0.5	0.8
Trucks	0	6	3	0	9	0	1	2	0	3	5	4	0	0	9	2	3	3	0	8	29
% Trucks	0	0.5	0.6	0	0.4	0	0.1	0.5	0	0.2	2	0.4	0	0	0.5	1.8	0.4	1.4	0	0.7	0.5

Start Time	EL CAMINO REAL Southbound				SAN ANTONIO RD Westbound				EL CAMINO REAL Northbound				SAN ANTONIO RD Eastbound				Int. Total
	Right	Thru	Left	App. Total	Right	Thru	Left	App. Total	Right	Thru	Left	App. Total	Right	Thru	Left	App. Total	
Peak Hour Analysis From 04:00 PM to 05:45 PM - Peak 1 of 1																	
Peak Hour for Entire Intersection Begins at 04:30 PM																	
04:30 PM	31	185	76	292	30	116	42	188	32	137	59	228	10	106	28	144	852
04:45 PM	21	169	55	245	29	72	55	156	32	135	36	203	14	87	22	123	727
05:00 PM	39	181	56	276	25	93	71	189	41	146	67	254	9	119	33	161	880
05:15 PM	31	175	66	272	16	88	51	155	29	138	80	247	20	102	25	147	821
Total Volume	122	710	253	1085	100	369	219	688	134	556	242	932	53	414	108	575	3280
% App. Total	11.2	65.4	23.3		14.5	53.6	31.8		14.4	59.7	26		9.2	72	18.8		
PHF	.782	.959	.832	.929	.833	.795	.771	.910	.817	.952	.756	.917	.663	.870	.818	.893	.932

Traffic Data Service

San Jose, CA
 (408) 622-4787
 tdsbay@cs.com

File Name : 3PM FINAL
 Site Code : 00000003
 Start Date : 4/27/2021
 Page No : 2

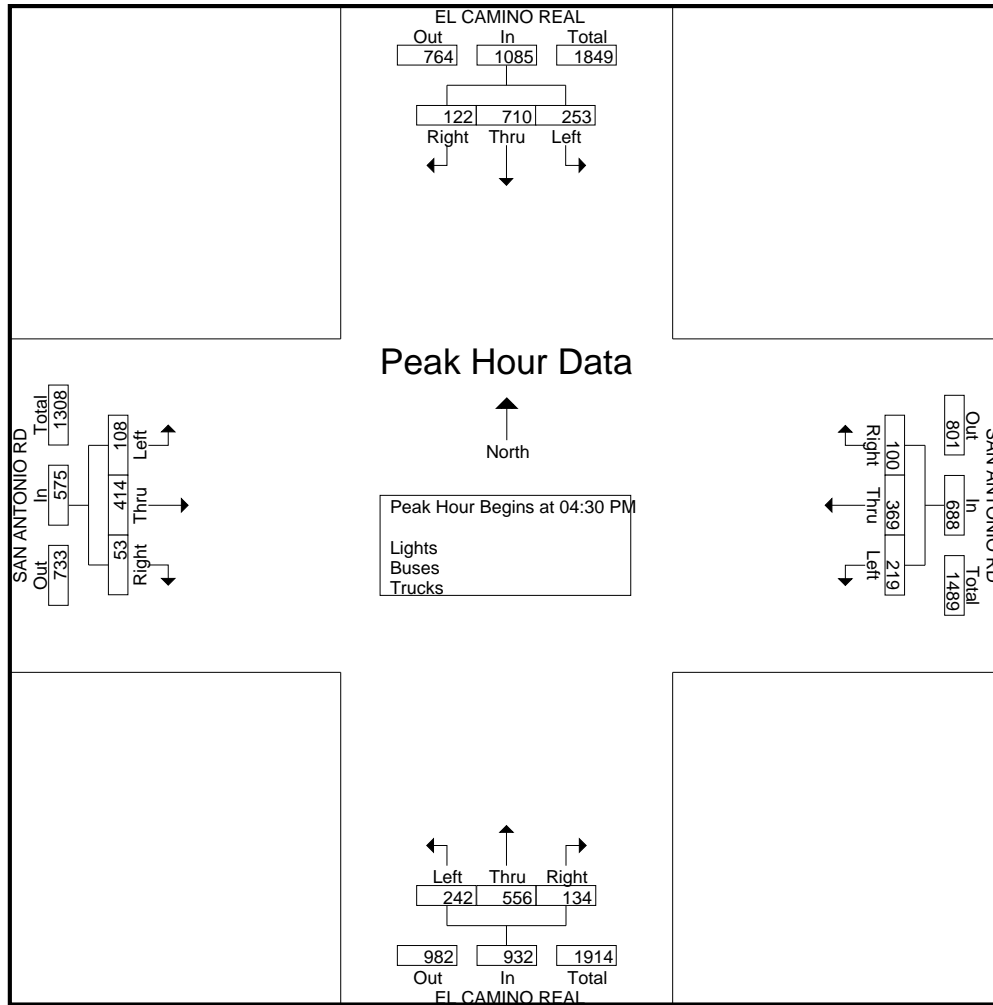

Traffic Data Service

San Jose, CA
 (408) 622-4787
 tdsbay@cs.com

File Name : 3PM FINAL
 Site Code : 00000003
 Start Date : 4/27/2021
 Page No : 1

Groups Printed- Bikes

Start Time	EL CAMINO REAL Southbound					SAN ANTONIO RD Westbound					EL CAMINO REAL Northbound					SAN ANTONIO RD Eastbound					Int. Total	
	Right	Thru	Left	Peds	App. Total	Right	Thru	Left	Peds	App. Total	Right	Thru	Left	Peds	App. Total	Right	Thru	Left	Peds	App. Total		
04:00 PM	0	1	0	0	1	0	1	0	0	1	0	0	0	0	0	0	0	0	0	0	0	2
04:15 PM	0	0	0	0	0	0	1	2	0	3	0	0	0	0	0	0	0	0	0	0	0	3
04:30 PM	0	0	0	0	0	0	1	0	0	1	0	0	0	0	0	0	0	0	0	0	0	1
04:45 PM	0	0	0	0	0	0	0	0	0	0	0	0	0	0	0	0	0	0	0	0	0	0
Total	0	1	0	0	1	0	3	2	0	5	0	0	0	0	0	0	0	0	0	0	0	6
05:00 PM	0	0	0	0	0	0	3	0	0	3	0	0	0	0	0	0	0	0	0	0	0	3
05:15 PM	0	1	0	0	1	0	0	0	0	0	0	0	0	0	0	0	0	0	0	0	0	1
05:30 PM	0	0	0	0	0	0	3	0	0	3	0	0	0	0	0	0	0	1	0	0	1	4
05:45 PM	0	0	0	0	0	0	0	0	0	0	0	0	0	0	0	0	0	0	0	0	0	0
Total	0	1	0	0	1	0	6	0	0	6	0	0	0	0	0	0	0	1	0	0	1	8
Grand Total	0	2	0	0	2	0	9	2	0	11	0	0	0	0	0	0	0	1	0	0	1	14
Apprch %	0	100	0	0		0	81.8	18.2	0		0	0	0	0		0	0	100	0			
Total %	0	14.3	0	0	14.3	0	64.3	14.3	0	78.6	0	0	0	0		0	0	7.1	0	7.1		

Start Time	EL CAMINO REAL Southbound					SAN ANTONIO RD Westbound					EL CAMINO REAL Northbound					SAN ANTONIO RD Eastbound					Int. Total	
	Right	Thru	Left	Peds	App. Total	Right	Thru	Left	Peds	App. Total	Right	Thru	Left	Peds	App. Total	Right	Thru	Left	Peds	App. Total		
04:45 PM	0	0	0	0	0	0	0	0	0	0	0	0	0	0	0	0	0	0	0	0	0	0
05:00 PM	0	0	0	0	0	0	3	0	0	3	0	0	0	0	0	0	0	0	0	0	0	3
05:15 PM	0	1	0	0	1	0	0	0	0	0	0	0	0	0	0	0	0	0	0	0	0	1
05:30 PM	0	0	0	0	0	0	3	0	0	3	0	0	0	0	0	0	0	1	0	0	1	4
Total Volume	0	1	0	0	1	0	6	0	0	6	0	0	0	0	0	0	0	1	0	0	1	8
% App. Total	0	100	0	0		0	100	0	0		0	0	0	0		0	0	100	0			
PHF	.000	.250	.000	.000	.250	.000	.500	.000	.000	.500	.000	.000	.000	.000	.000	.000	.000	.250	.000	.250	.500	

Peak Hour Analysis From 04:00 PM to 05:45 PM - Peak 1 of 1

Peak Hour for Entire Intersection Begins at 04:45 PM

Traffic Data Service

San Jose, CA
 (408) 622-4787
 tdsbay@cs.com

File Name : 3PM FINAL
 Site Code : 00000003
 Start Date : 4/27/2021
 Page No : 2

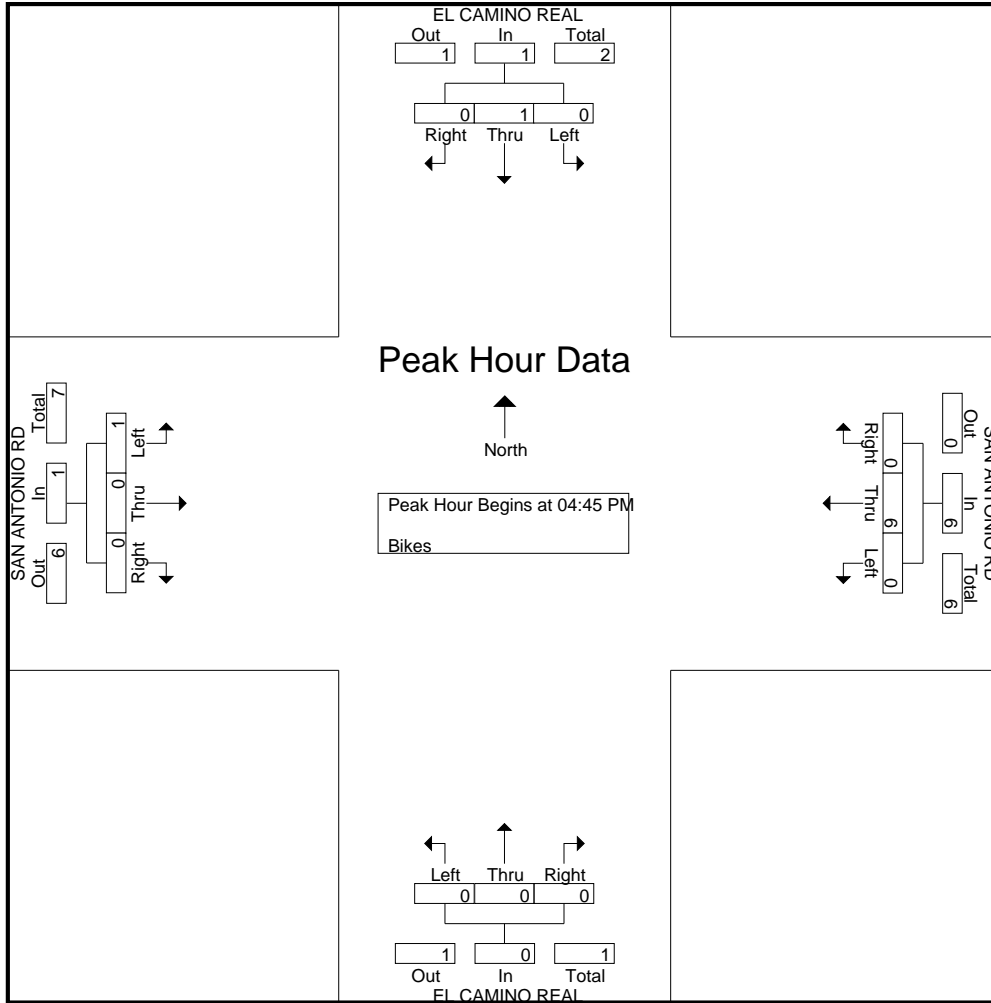

Traffic Data Service

San Jose, CA
(408) 622-4787
tdsbay@cs.com

File Name : 4AM FINAL
 Site Code : 00000004
 Start Date : 4/27/2021
 Page No : 1

Groups Printed- Lights - Buses - Trucks

Start Time	EL CAMINO REAL Southbound					SHOWERS DR Westbound					EL CAMINO REAL Northbound					DRIVEWAY Eastbound					Int. Total
	Right	Thru	Left	Peds	App. Total	Right	Thru	Left	Peds	App. Total	Right	Thru	Left	Peds	App. Total	Right	Thru	Left	Peds	App. Total	
07:00 AM	1	53	15	0	69	10	0	10	1	21	8	100	4	0	112	1	0	0	3	4	206
07:15 AM	1	64	14	7	86	12	0	13	1	26	9	136	5	0	150	1	0	0	5	6	268
07:30 AM	4	86	18	6	114	12	0	5	0	17	12	133	4	0	149	0	0	0	2	2	282
07:45 AM	6	90	14	4	114	19	4	11	0	34	20	173	6	0	199	1	0	0	3	4	351
Total	12	293	61	17	383	53	4	39	2	98	49	542	19	0	610	3	0	0	13	16	1107
08:00 AM	9	96	20	4	129	22	1	17	4	44	20	150	4	0	174	0	2	1	2	5	352
08:15 AM	11	119	24	6	160	18	4	27	2	51	25	165	10	0	200	1	1	2	2	6	417
08:30 AM	12	128	38	8	186	13	4	18	6	41	32	177	4	0	213	4	1	3	2	10	450
08:45 AM	12	109	34	1	156	17	1	14	4	36	22	177	11	0	210	4	2	2	0	8	410
Total	44	452	116	19	631	70	10	76	16	172	99	669	29	0	797	9	6	8	6	29	1629
Grand Total	56	745	177	36	1014	123	14	115	18	270	148	1211	48	0	1407	12	6	8	19	45	2736
Apprch %	5.5	73.5	17.5	3.6		45.6	5.2	42.6	6.7		10.5	86.1	3.4	0		26.7	13.3	17.8	42.2		
Total %	2	27.2	6.5	1.3	37.1	4.5	0.5	4.2	0.7	9.9	5.4	44.3	1.8	0	51.4	0.4	0.2	0.3	0.7	1.6	
Lights	52	692	163	36	943	109	12	113	18	252	146	1178	42	0	1366	12	6	8	19	45	2606
% Lights	92.9	92.9	92.1	100	93	88.6	85.7	98.3	100	93.3	98.6	97.3	87.5	0	97.1	100	100	100	100	100	95.2
Buses	0	19	3	0	22	13	0	0	0	13	2	15	0	0	17	0	0	0	0	0	52
% Buses	0	2.6	1.7	0	2.2	10.6	0	0	0	4.8	1.4	1.2	0	0	1.2	0	0	0	0	0	1.9
Trucks	4	34	11	0	49	1	2	2	0	5	0	18	6	0	24	0	0	0	0	0	78
% Trucks	7.1	4.6	6.2	0	4.8	0.8	14.3	1.7	0	1.9	0	1.5	12.5	0	1.7	0	0	0	0	0	2.9

Start Time	EL CAMINO REAL Southbound				SHOWERS DR Westbound				EL CAMINO REAL Northbound				DRIVEWAY Eastbound				Int. Total
	Right	Thru	Left	App. Total	Right	Thru	Left	App. Total	Right	Thru	Left	App. Total	Right	Thru	Left	App. Total	
Peak Hour Analysis From 07:00 AM to 08:45 AM - Peak 1 of 1																	
Peak Hour for Entire Intersection Begins at 08:00 AM																	
08:00 AM	9	96	20	125	22	1	17	40	20	150	4	174	0	2	1	3	342
08:15 AM	11	119	24	154	18	4	27	49	25	165	10	200	1	1	2	4	407
08:30 AM	12	128	38	178	13	4	18	35	32	177	4	213	4	1	3	8	434
08:45 AM	12	109	34	155	17	1	14	32	22	177	11	210	4	2	2	8	405
Total Volume	44	452	116	612	70	10	76	156	99	669	29	797	9	6	8	23	1588
% App. Total	7.2	73.9	19		44.9	6.4	48.7		12.4	83.9	3.6		39.1	26.1	34.8		
PHF	.917	.883	.763	.860	.795	.625	.704	.796	.773	.945	.659	.935	.563	.750	.667	.719	.915

Traffic Data Service

San Jose, CA
 (408) 622-4787
 tdsbay@cs.com

File Name : 4AM FINAL
 Site Code : 00000004
 Start Date : 4/27/2021
 Page No : 2

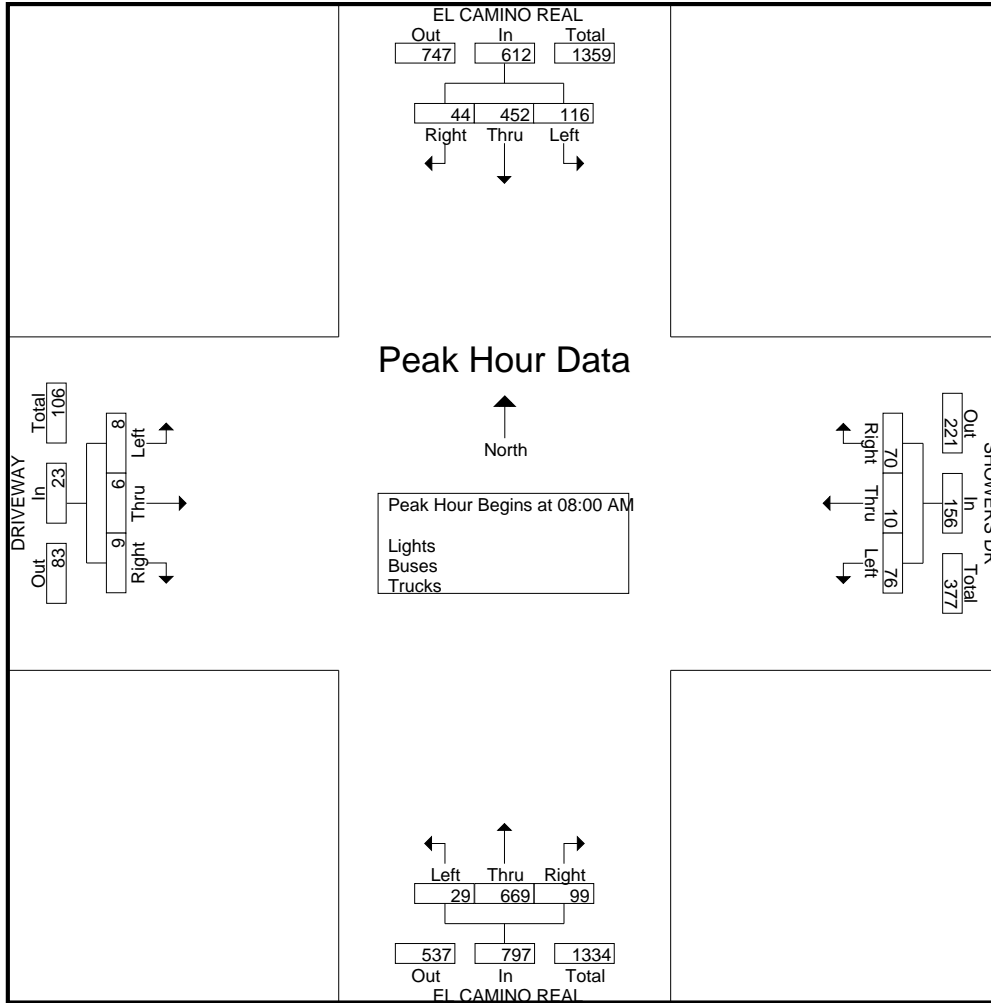

Traffic Data Service

San Jose, CA
 (408) 622-4787
 tdsbay@cs.com

File Name : 4AM FINAL
 Site Code : 00000004
 Start Date : 4/27/2021
 Page No : 1

Groups Printed- Bikes

Start Time	EL CAMINO REAL Southbound					SHOWERS DR Westbound					EL CAMINO REAL Northbound					DRIVEWAY Eastbound					Int. Total
	Right	Thru	Left	Peds	App. Total	Right	Thru	Left	Peds	App. Total	Right	Thru	Left	Peds	App. Total	Right	Thru	Left	Peds	App. Total	
07:00 AM	0	0	0	0	0	0	0	0	0	0	0	0	0	0	0	0	0	0	0	0	0
07:15 AM	0	0	0	0	0	0	0	2	0	2	0	0	0	0	0	0	0	0	0	0	0
07:30 AM	0	0	0	0	0	0	0	0	0	0	0	2	0	0	2	0	0	0	0	0	0
07:45 AM	0	1	0	0	1	0	0	0	0	0	0	2	0	0	2	0	0	0	0	0	0
Total	0	1	0	0	1	0	0	2	0	2	0	4	0	0	4	0	0	0	0	0	0
08:00 AM	0	0	0	0	0	0	0	0	0	0	0	0	0	0	0	0	0	0	0	0	0
08:15 AM	0	0	0	0	0	0	0	0	0	0	0	0	0	0	0	0	0	0	0	0	0
08:30 AM	0	0	0	0	0	0	0	0	0	0	0	0	0	0	0	0	0	0	0	0	0
08:45 AM	0	0	0	0	0	0	0	0	0	0	0	0	0	0	0	1	0	0	0	1	1
Total	0	0	0	0	0	0	0	0	0	0	0	0	0	0	0	1	0	0	0	1	1
Grand Total	0	1	0	0	1	0	0	2	0	2	0	4	0	0	4	1	0	0	0	1	8
Apprch %	0	100	0	0		0	0	100	0		0	100	0	0		100	0	0	0		
Total %	0	12.5	0	0	12.5	0	0	25	0	25	0	50	0	0	50	12.5	0	0	0	12.5	

Start Time	EL CAMINO REAL Southbound				SHOWERS DR Westbound				EL CAMINO REAL Northbound				DRIVEWAY Eastbound				Int. Total
	Right	Thru	Left	App. Total	Right	Thru	Left	App. Total	Right	Thru	Left	App. Total	Right	Thru	Left	App. Total	
Peak Hour Analysis From 07:00 AM to 08:45 AM - Peak 1 of 1																	
Peak Hour for Entire Intersection Begins at 07:00 AM																	
07:00 AM	0	0	0	0	0	0	0	0	0	0	0	0	0	0	0	0	0
07:15 AM	0	0	0	0	0	0	2	2	0	0	0	0	0	0	0	0	0
07:30 AM	0	0	0	0	0	0	0	0	0	2	0	2	0	0	0	0	0
07:45 AM	0	1	0	1	0	0	0	0	0	2	0	2	0	0	0	0	0
Total Volume	0	1	0	1	0	0	2	2	0	4	0	4	0	0	0	0	0
% App. Total	0	100	0		0	0	100		0	100	0		0	0	0		
PHF	.000	.250	.000	.250	.000	.000	.250	.250	.000	.500	.000	.500	.000	.000	.000	.000	.583

Traffic Data Service

San Jose, CA
 (408) 622-4787
 tdsbay@cs.com

File Name : 4AM FINAL
 Site Code : 00000004
 Start Date : 4/27/2021
 Page No : 2

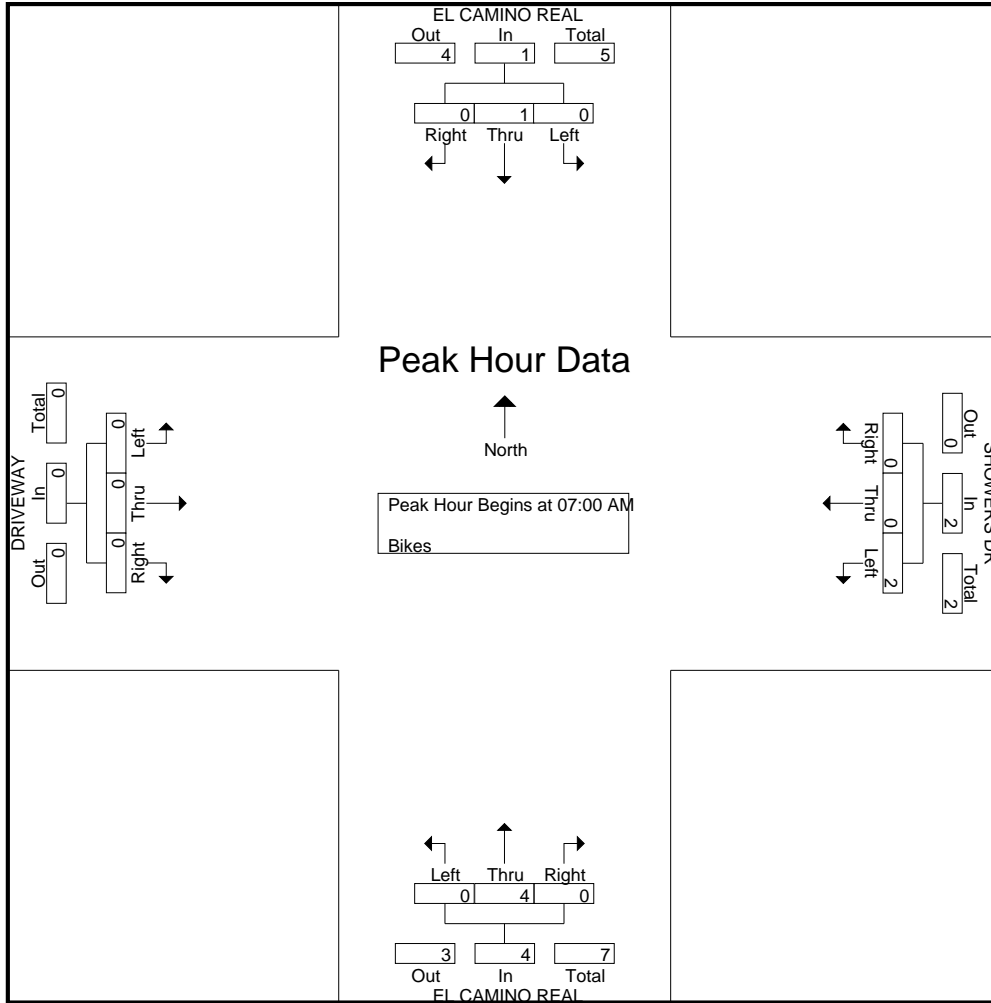

Traffic Data Service

San Jose, CA
 (408) 622-4787
 tdsbay@cs.com

File Name : 4PM FINAL
 Site Code : 00000004
 Start Date : 4/27/2021
 Page No : 1

Groups Printed- Lights - Buses - Trucks

Start Time	EL CAMINO REAL Southbound					SHOWERS DR Westbound					EL CAMINO REAL Northbound					DRIVEWAY Eastbound					Int. Total
	Right	Thru	Left	Peds	App. Total	Right	Thru	Left	Peds	App. Total	Right	Thru	Left	Peds	App. Total	Right	Thru	Left	Peds	App. Total	
04:00 PM	18	154	52	9	233	30	6	42	5	83	30	151	9	0	190	9	4	12	8	33	539
04:15 PM	17	210	46	13	286	27	4	37	6	74	32	172	15	0	219	8	2	7	2	19	598
04:30 PM	16	213	58	11	298	29	7	39	10	85	28	149	10	0	187	10	3	6	2	21	591
04:45 PM	14	215	48	15	292	23	2	45	3	73	30	167	17	0	214	12	3	14	1	30	609
Total	65	792	204	48	1109	109	19	163	24	315	120	639	51	0	810	39	12	39	13	103	2337
05:00 PM	16	230	40	9	295	26	4	46	3	79	40	188	17	0	245	6	2	9	5	22	641
05:15 PM	14	239	47	13	313	28	9	29	1	67	32	177	17	0	226	16	1	9	9	35	641
05:30 PM	17	179	56	16	268	17	8	38	6	69	36	158	13	0	207	11	2	6	10	29	573
05:45 PM	19	186	40	7	252	27	2	43	2	74	40	146	13	0	199	12	4	9	3	28	553
Total	66	834	183	45	1128	98	23	156	12	289	148	669	60	0	877	45	9	33	27	114	2408
Grand Total	131	1626	387	93	2237	207	42	319	36	604	268	1308	111	0	1687	84	21	72	40	217	4745
Apprch %	5.9	72.7	17.3	4.2		34.3	7	52.8	6		15.9	77.5	6.6	0		38.7	9.7	33.2	18.4		
Total %	2.8	34.3	8.2	2	47.1	4.4	0.9	6.7	0.8	12.7	5.6	27.6	2.3	0	35.6	1.8	0.4	1.5	0.8	4.6	
Lights	131	1600	382	93	2206	195	42	315	36	588	263	1284	111	0	1658	84	21	72	40	217	4669
% Lights	100	98.4	98.7	100	98.6	94.2	100	98.7	100	97.4	98.1	98.2	100	0	98.3	100	100	100	100	100	98.4
Buses	0	16	5	0	21	12	0	0	0	12	5	18	0	0	23	0	0	0	0	0	56
% Buses	0	1	1.3	0	0.9	5.8	0	0	0	2	1.9	1.4	0	0	1.4	0	0	0	0	0	1.2
Trucks	0	10	0	0	10	0	0	4	0	4	0	6	0	0	6	0	0	0	0	0	20
% Trucks	0	0.6	0	0	0.4	0	0	1.3	0	0.7	0	0.5	0	0	0.4	0	0	0	0	0	0.4

Start Time	EL CAMINO REAL Southbound				SHOWERS DR Westbound				EL CAMINO REAL Northbound				DRIVEWAY Eastbound				Int. Total
	Right	Thru	Left	App. Total	Right	Thru	Left	App. Total	Right	Thru	Left	App. Total	Right	Thru	Left	App. Total	
Peak Hour Analysis From 04:00 PM to 05:45 PM - Peak 1 of 1																	
Peak Hour for Entire Intersection Begins at 04:30 PM																	
04:30 PM	16	213	58	287	29	7	39	75	28	149	10	187	10	3	6	19	568
04:45 PM	14	215	48	277	23	2	45	70	30	167	17	214	12	3	14	29	590
05:00 PM	16	230	40	286	26	4	46	76	40	188	17	245	6	2	9	17	624
05:15 PM	14	239	47	300	28	9	29	66	32	177	17	226	16	1	9	26	618
Total Volume	60	897	193	1150	106	22	159	287	130	681	61	872	44	9	38	91	2400
% App. Total	5.2	78	16.8		36.9	7.7	55.4		14.9	78.1	7		48.4	9.9	41.8		
PHF	.938	.938	.832	.958	.914	.611	.864	.944	.813	.906	.897	.890	.688	.750	.679	.784	.962

Traffic Data Service

San Jose, CA
 (408) 622-4787
 tdsbay@cs.com

File Name : 4PM FINAL
 Site Code : 00000004
 Start Date : 4/27/2021
 Page No : 2

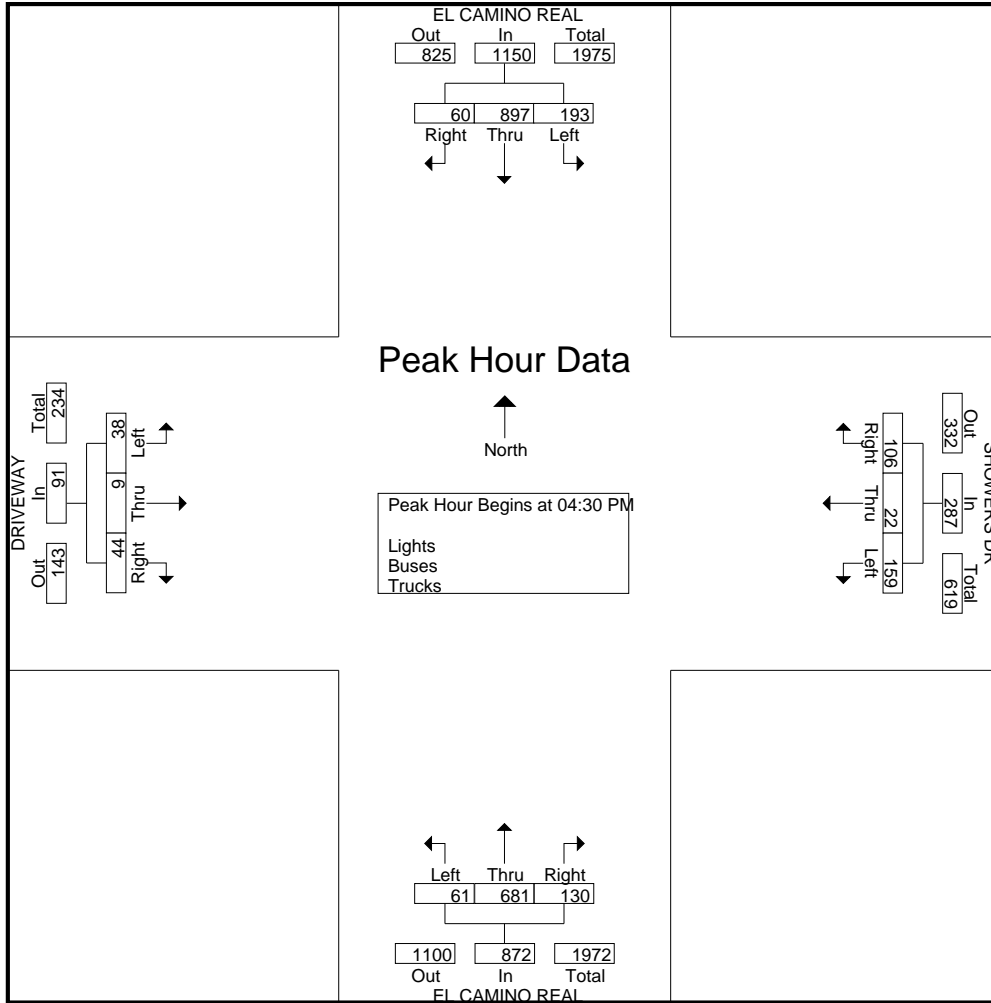

Traffic Data Service

San Jose, CA
 (408) 622-4787
 tdsbay@cs.com

File Name : 4PM FINAL
 Site Code : 00000004
 Start Date : 4/27/2021
 Page No : 1

Groups Printed- Bikes

Start Time	EL CAMINO REAL Southbound					SHOWERS DR Westbound					EL CAMINO REAL Northbound					DRIVEWAY Eastbound					Int. Total
	Right	Thru	Left	Peds	App. Total	Right	Thru	Left	Peds	App. Total	Right	Thru	Left	Peds	App. Total	Right	Thru	Left	Peds	App. Total	
04:00 PM	0	1	0	0	1	0	0	0	0	0	0	0	0	0	0	0	0	0	0	0	0
04:15 PM	0	0	0	0	0	0	0	0	0	0	0	0	0	0	0	0	0	0	0	0	0
04:30 PM	0	0	0	0	0	0	1	0	0	1	0	0	0	0	0	0	0	0	0	0	1
04:45 PM	0	0	0	0	0	1	0	0	0	1	0	0	0	0	0	0	0	0	0	0	1
Total	0	1	0	0	1	1	1	0	0	2	0	0	0	0	0	0	0	0	0	0	3
05:00 PM	0	0	0	0	0	0	0	0	0	0	0	0	0	0	0	0	0	0	0	0	0
05:15 PM	0	0	0	0	0	0	0	0	0	0	0	0	0	0	0	2	1	0	0	3	3
05:30 PM	0	0	0	0	0	0	0	0	0	0	0	0	0	0	0	0	0	0	0	0	0
05:45 PM	0	1	0	0	1	0	0	0	0	0	0	0	0	0	0	0	0	0	0	0	1
Total	0	1	0	0	1	0	0	0	0	0	0	0	0	0	0	2	1	0	0	3	4
Grand Total	0	2	0	0	2	1	1	0	0	2	0	0	0	0	0	2	1	0	0	3	7
Apprch %	0	100	0	0		50	50	0	0		0	0	0	0		66.7	33.3	0	0		
Total %	0	28.6	0	0	28.6	14.3	14.3	0	0	28.6	0	0	0	0	0	28.6	14.3	0	0	42.9	

Start Time	EL CAMINO REAL Southbound					SHOWERS DR Westbound					EL CAMINO REAL Northbound					DRIVEWAY Eastbound					Int. Total
	Right	Thru	Left	Peds	App. Total	Right	Thru	Left	Peds	App. Total	Right	Thru	Left	Peds	App. Total	Right	Thru	Left	Peds	App. Total	
04:30 PM	0	0	0	0	0	0	1	0	0	1	0	0	0	0	0	0	0	0	0	0	1
04:45 PM	0	0	0	0	0	1	0	0	0	1	0	0	0	0	0	0	0	0	0	0	1
05:00 PM	0	0	0	0	0	0	0	0	0	0	0	0	0	0	0	0	0	0	0	0	0
05:15 PM	0	0	0	0	0	0	0	0	0	0	0	0	0	0	0	2	1	0	0	3	3
Total Volume	0	0	0	0	0	1	1	0	0	2	0	0	0	0	0	2	1	0	0	3	5
% App. Total	0	0	0	0		50	50	0	0		0	0	0	0		66.7	33.3	0	0		
PHF	.000	.000	.000	.000	.000	.250	.250	.000	.000	.500	.000	.000	.000	.000	.000	.250	.250	.000	.000	.250	.417

Peak Hour Analysis From 04:00 PM to 05:45 PM - Peak 1 of 1
 Peak Hour for Entire Intersection Begins at 04:30 PM

Traffic Data Service

San Jose, CA
 (408) 622-4787
 tdsbay@cs.com

File Name : 4PM FINAL
 Site Code : 00000004
 Start Date : 4/27/2021
 Page No : 2

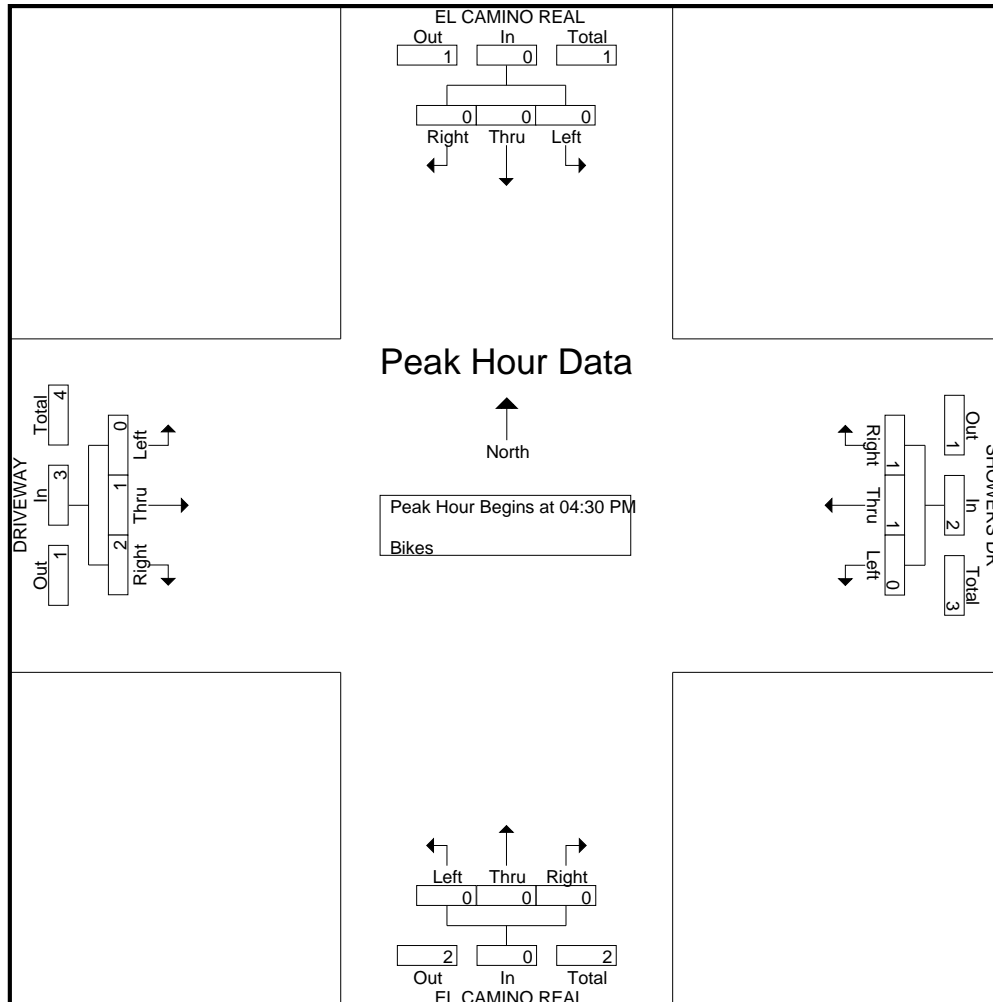

Traffic Data Service

San Jose, CA
 (408) 622-4787
 tdsbay@cs.com

File Name : 5AM FINAL
 Site Code : 00000005
 Start Date : 4/27/2021
 Page No : 1

Groups Printed- Lights - Buses - Trucks

Start Time	EL CAMINO REAL Southbound					ORTEGA AVE Westbound					EL CAMINO REAL Northbound					DRIVEWAY Eastbound					Int. Total
	Right	Thru	Left	Peds	App. Total	Right	Thru	Left	Peds	App. Total	Right	Thru	Left	Peds	App. Total	Right	Thru	Left	Peds	App. Total	
07:00 AM	0	60	5	0	65	4	0	3	1	8	6	113	3	0	122	0	0	0	1	1	196
07:15 AM	2	68	2	0	72	3	0	5	0	8	12	151	1	0	164	0	0	0	0	0	244
07:30 AM	1	90	2	1	94	11	0	5	2	18	10	146	3	0	159	1	0	0	0	1	272
07:45 AM	0	104	4	1	109	8	0	5	1	14	11	200	0	0	211	0	0	0	1	1	335
Total	3	322	13	2	340	26	0	18	4	48	39	610	7	0	656	1	0	0	2	3	1047
08:00 AM	0	114	4	4	122	5	0	27	1	33	11	178	6	0	195	0	0	0	3	3	353
08:15 AM	0	147	1	1	149	17	0	20	1	38	15	185	3	0	203	0	0	0	4	4	394
08:30 AM	1	137	7	0	145	6	0	11	3	20	32	202	2	0	236	0	0	1	0	1	402
08:45 AM	1	119	5	0	125	8	0	8	2	18	21	218	3	0	242	0	0	0	1	1	386
Total	2	517	17	5	541	36	0	66	7	109	79	783	14	0	876	0	0	1	8	9	1535
Grand Total	5	839	30	7	881	62	0	84	11	157	118	1393	21	0	1532	1	0	1	10	12	2582
Apprch %	0.6	95.2	3.4	0.8		39.5	0	53.5	7		7.7	90.9	1.4	0		8.3	0	8.3	83.3		
Total %	0.2	32.5	1.2	0.3	34.1	2.4	0	3.3	0.4	6.1	4.6	54	0.8	0	59.3	0	0	0	0.4	0.5	
Lights	5	788	29	7	829	62	0	84	11	157	111	1349	21	0	1481	1	0	1	10	12	2479
% Lights	100	93.9	96.7	100	94.1	100	0	100	100	100	94.1	96.8	100	0	96.7	100	0	100	100	100	96
Buses	0	19	0	0	19	0	0	0	0	0	2	17	0	0	19	0	0	0	0	0	38
% Buses	0	2.3	0	0	2.2	0	0	0	0	0	1.7	1.2	0	0	1.2	0	0	0	0	0	1.5
Trucks	0	32	1	0	33	0	0	0	0	0	5	27	0	0	32	0	0	0	0	0	65
% Trucks	0	3.8	3.3	0	3.7	0	0	0	0	0	4.2	1.9	0	0	2.1	0	0	0	0	0	2.5

Start Time	EL CAMINO REAL Southbound				ORTEGA AVE Westbound				EL CAMINO REAL Northbound				DRIVEWAY Eastbound				Int. Total
	Right	Thru	Left	App. Total	Right	Thru	Left	App. Total	Right	Thru	Left	App. Total	Right	Thru	Left	App. Total	
Peak Hour Analysis From 07:00 AM to 08:45 AM - Peak 1 of 1																	
Peak Hour for Entire Intersection Begins at 08:00 AM																	
08:00 AM	0	114	4	118	5	0	27	32	11	178	6	195	0	0	0	0	345
08:15 AM	0	147	1	148	17	0	20	37	15	185	3	203	0	0	0	0	388
08:30 AM	1	137	7	145	6	0	11	17	32	202	2	236	0	0	1	1	399
08:45 AM	1	119	5	125	8	0	8	16	21	218	3	242	0	0	0	0	383
Total Volume	2	517	17	536	36	0	66	102	79	783	14	876	0	0	1	1	1515
% App. Total	0.4	96.5	3.2		35.3	0	64.7		9	89.4	1.6		0	0	100		
PHF	.500	.879	.607	.905	.529	.000	.611	.689	.617	.898	.583	.905	.000	.000	.250	.250	.949

Traffic Data Service

San Jose, CA
 (408) 622-4787
 tdsbay@cs.com

File Name : 5AM FINAL
 Site Code : 00000005
 Start Date : 4/27/2021
 Page No : 2

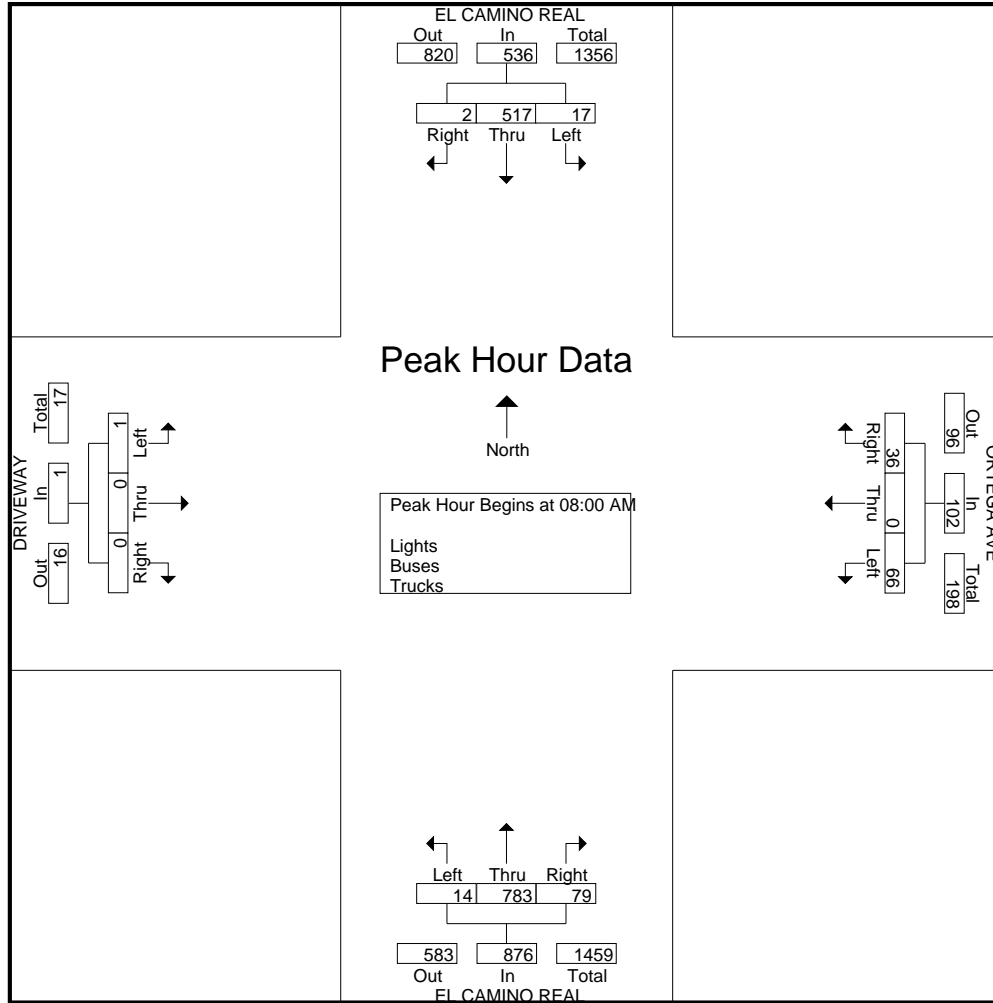

Traffic Data Service

San Jose, CA
 (408) 622-4787
 tdsbay@cs.com

File Name : 5AM FINAL
 Site Code : 00000005
 Start Date : 4/27/2021
 Page No : 1

Groups Printed- Bikes

Start Time	EL CAMINO REAL Southbound					ORTEGA AVE Westbound					EL CAMINO REAL Northbound					DRIVEWAY Eastbound					Int. Total
	Right	Thru	Left	Peds	App. Total	Right	Thru	Left	Peds	App. Total	Right	Thru	Left	Peds	App. Total	Right	Thru	Left	Peds	App. Total	
07:00 AM	0	0	0	0	0	0	0	0	0	0	0	0	0	0	0	0	0	0	0	0	0
07:15 AM	0	0	0	0	0	0	1	0	0	1	0	0	0	0	0	0	0	0	0	0	0
07:30 AM	0	0	0	0	0	0	0	0	0	0	0	2	0	0	2	0	0	0	0	0	0
07:45 AM	0	0	0	0	0	0	1	0	0	1	0	1	0	0	1	0	0	0	0	0	0
Total	0	0	0	0	0	0	2	0	0	2	0	3	0	0	3	0	0	0	0	0	0
08:00 AM	0	0	0	0	0	0	0	0	0	0	0	0	0	0	0	0	0	0	0	0	0
08:15 AM	0	0	0	0	0	0	0	0	0	0	0	0	0	0	0	0	0	0	0	0	0
08:30 AM	0	0	0	0	0	0	0	0	0	0	0	0	0	0	0	0	0	0	0	0	0
08:45 AM	0	1	0	0	1	0	0	0	0	0	0	0	0	0	0	0	0	0	0	0	0
Total	0	1	0	0	1	0	0	0	0	0	0	0	0	0	0	0	0	0	0	0	0
Grand Total	0	1	0	0	1	0	2	0	0	2	0	3	0	0	3	0	0	0	0	0	6
Apprch %	0	100	0	0		0	100	0	0		0	100	0	0		0	0	0	0		
Total %	0	16.7	0	0	16.7	0	33.3	0	0	33.3	0	50	0	0	50	0	0	0	0	0	

Start Time	EL CAMINO REAL Southbound				ORTEGA AVE Westbound				EL CAMINO REAL Northbound				DRIVEWAY Eastbound				Int. Total
	Right	Thru	Left	App. Total	Right	Thru	Left	App. Total	Right	Thru	Left	App. Total	Right	Thru	Left	App. Total	
Peak Hour Analysis From 07:00 AM to 08:45 AM - Peak 1 of 1																	
Peak Hour for Entire Intersection Begins at 07:00 AM																	
07:00 AM	0	0	0	0	0	0	0	0	0	0	0	0	0	0	0	0	0
07:15 AM	0	0	0	0	0	1	0	1	0	0	0	0	0	0	0	0	0
07:30 AM	0	0	0	0	0	0	0	0	0	2	0	2	0	0	0	0	0
07:45 AM	0	0	0	0	0	1	0	1	0	1	0	1	0	0	0	0	0
Total Volume	0	0	0	0	0	2	0	2	0	3	0	3	0	0	0	0	5
% App. Total	0	0	0		0	100	0		0	100	0		0	0	0		
PHF	.000	.000	.000	.000	.000	.500	.000	.500	.000	.375	.000	.375	.000	.000	.000	.000	.625

Traffic Data Service

San Jose, CA
 (408) 622-4787
 tdsbay@cs.com

File Name : 5AM FINAL
 Site Code : 00000005
 Start Date : 4/27/2021
 Page No : 2

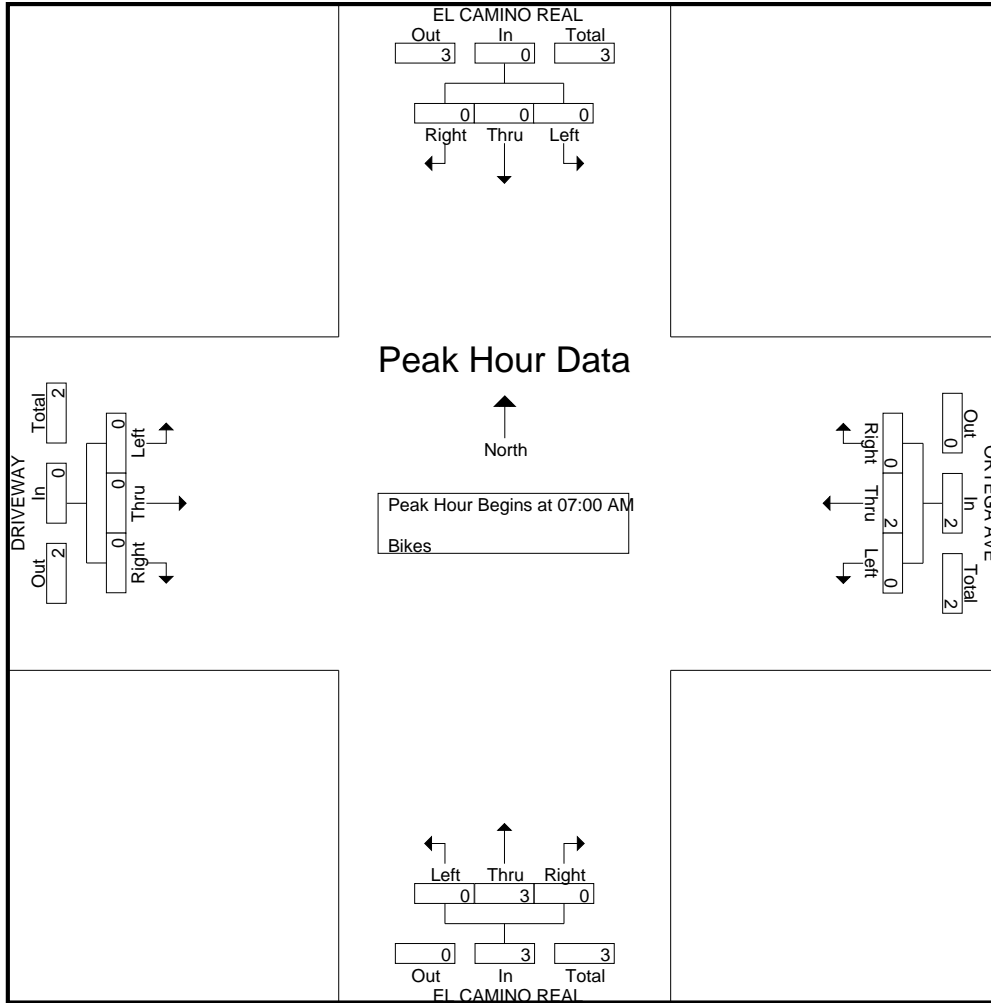

Traffic Data Service

San Jose, CA
 (408) 622-4787
 tdsbay@cs.com

File Name : 5PM FINAL
 Site Code : 00000005
 Start Date : 4/27/2021
 Page No : 1

Groups Printed- Lights - Buses - Trucks

Start Time	EL CAMINO REAL Southbound					ORTEGA AVE Westbound					EL CAMINO REAL Northbound					DRIVEWAY Eastbound					Int. Total
	Right	Thru	Left	Peds	App. Total	Right	Thru	Left	Peds	App. Total	Right	Thru	Left	Peds	App. Total	Right	Thru	Left	Peds	App. Total	
04:00 PM	0	208	7	1	216	5	0	13	5	23	15	184	2	0	201	0	0	2	0	2	442
04:15 PM	0	266	3	3	272	4	0	5	2	11	17	200	0	0	217	0	0	0	6	6	506
04:30 PM	0	252	11	1	264	13	0	15	4	32	21	165	2	0	188	0	0	1	1	2	486
04:45 PM	0	269	10	4	283	5	2	12	1	20	15	196	1	0	212	1	0	0	4	5	520
Total	0	995	31	9	1035	27	2	45	12	86	68	745	5	0	818	1	0	3	11	15	1954
05:00 PM	0	283	9	1	293	8	0	8	3	19	15	215	1	0	231	0	2	1	6	9	552
05:15 PM	0	279	13	1	293	7	0	10	3	20	17	189	3	0	209	1	0	1	6	8	530
05:30 PM	0	223	8	0	231	12	1	9	3	25	15	196	4	0	215	1	0	1	2	4	475
05:45 PM	0	229	9	2	240	7	0	10	3	20	20	180	2	0	202	1	1	0	2	4	466
Total	0	1014	39	4	1057	34	1	37	12	84	67	780	10	0	857	3	3	3	16	25	2023
Grand Total	0	2009	70	13	2092	61	3	82	24	170	135	1525	15	0	1675	4	3	6	27	40	3977
Apprch %	0	96	3.3	0.6		35.9	1.8	48.2	14.1		8.1	91	0.9	0		10	7.5	15	67.5		
Total %	0	50.5	1.8	0.3	52.6	1.5	0.1	2.1	0.6	4.3	3.4	38.3	0.4	0	42.1	0.1	0.1	0.2	0.7	1	
Lights	0	1979	70	13	2062	60	3	79	24	166	134	1498	15	0	1647	4	3	6	27	40	3915
% Lights	0	98.5	100	100	98.6	98.4	100	96.3	100	97.6	99.3	98.2	100	0	98.3	100	100	100	100	100	98.4
Buses	0	17	0	0	17	0	0	0	0	0	0	22	0	0	22	0	0	0	0	0	39
% Buses	0	0.8	0	0	0.8	0	0	0	0	0	0	1.4	0	0	1.3	0	0	0	0	0	1
Trucks	0	13	0	0	13	1	0	3	0	4	1	5	0	0	6	0	0	0	0	0	23
% Trucks	0	0.6	0	0	0.6	1.6	0	3.7	0	2.4	0.7	0.3	0	0	0.4	0	0	0	0	0	0.6

Start Time	EL CAMINO REAL Southbound				ORTEGA AVE Westbound				EL CAMINO REAL Northbound				DRIVEWAY Eastbound				Int. Total
	Right	Thru	Left	App. Total	Right	Thru	Left	App. Total	Right	Thru	Left	App. Total	Right	Thru	Left	App. Total	
Peak Hour Analysis From 04:00 PM to 05:45 PM - Peak 1 of 1																	
Peak Hour for Entire Intersection Begins at 04:30 PM																	
04:30 PM	0	252	11	263	13	0	15	28	21	165	2	188	0	0	1	1	480
04:45 PM	0	269	10	279	5	2	12	19	15	196	1	212	1	0	0	1	511
05:00 PM	0	283	9	292	8	0	8	16	15	215	1	231	0	2	1	3	542
05:15 PM	0	279	13	292	7	0	10	17	17	189	3	209	1	0	1	2	520
Total Volume	0	1083	43	1126	33	2	45	80	68	765	7	840	2	2	3	7	2053
% App. Total	0	96.2	3.8		41.2	2.5	56.2		8.1	91.1	0.8		28.6	28.6	42.9		
PHF	.000	.957	.827	.964	.635	.250	.750	.714	.810	.890	.583	.909	.500	.250	.750	.583	.947

Traffic Data Service

San Jose, CA
 (408) 622-4787
 tdsbay@cs.com

File Name : 5PM FINAL
 Site Code : 00000005
 Start Date : 4/27/2021
 Page No : 2

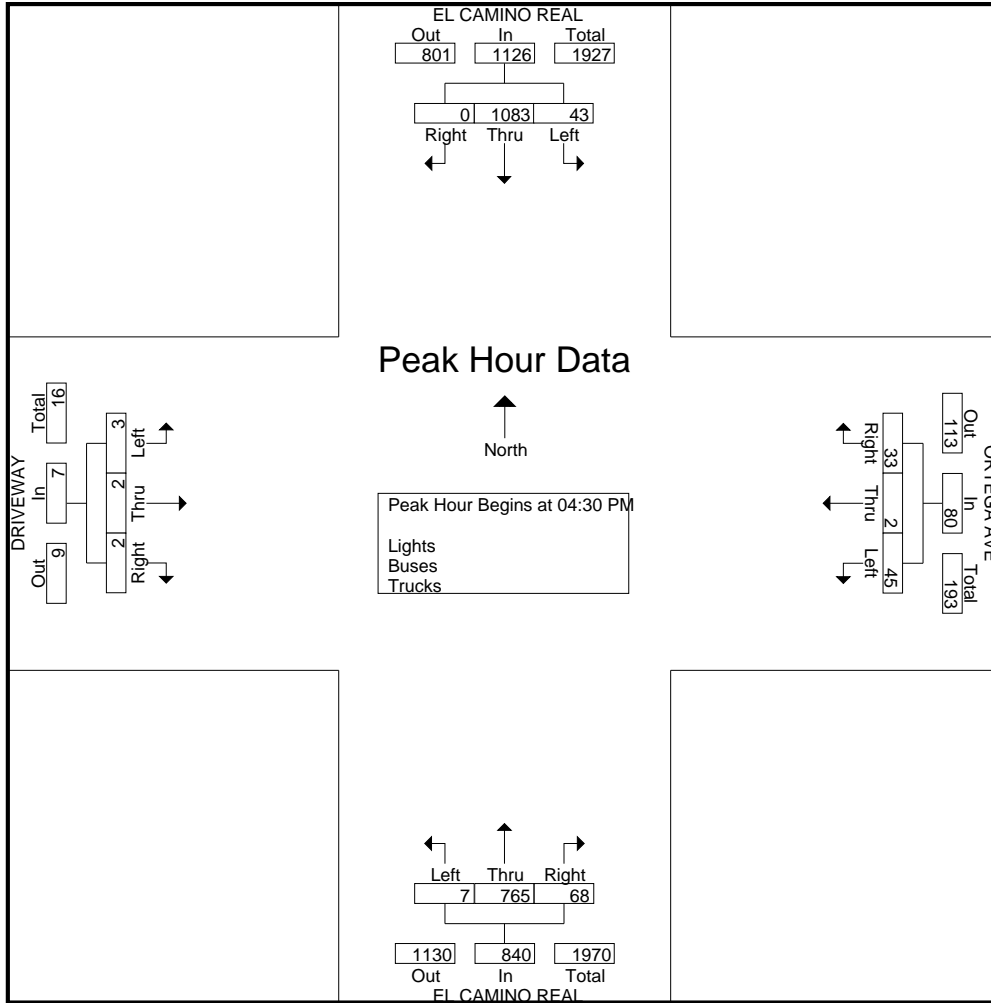

Traffic Data Service

San Jose, CA
 (408) 622-4787
 tdsbay@cs.com

File Name : 5PM FINAL
 Site Code : 00000005
 Start Date : 4/27/2021
 Page No : 1

Groups Printed- Bikes

Start Time	EL CAMINO REAL Southbound					ORTEGA AVE Westbound					EL CAMINO REAL Northbound					DRIVEWAY Eastbound					Int. Total
	Right	Thru	Left	Peds	App. Total	Right	Thru	Left	Peds	App. Total	Right	Thru	Left	Peds	App. Total	Right	Thru	Left	Peds	App. Total	
04:00 PM	0	2	0	0	2	0	0	0	0	0	0	0	0	0	0	0	0	0	0	0	0
04:15 PM	0	0	0	0	0	0	1	0	0	1	0	0	0	0	0	0	0	0	0	0	0
04:30 PM	0	0	0	0	0	1	0	0	0	1	0	0	0	0	0	0	1	0	0	1	2
04:45 PM	0	0	0	0	0	0	0	0	0	0	0	0	0	0	0	0	0	0	0	0	0
Total	0	2	0	0	2	1	1	0	0	2	0	0	0	0	0	0	1	0	0	1	5
05:00 PM	1	0	0	0	1	0	0	0	0	0	0	0	0	0	0	0	0	0	0	0	1
05:15 PM	0	2	0	0	2	0	0	0	0	0	0	0	0	0	0	0	1	0	0	1	3
05:30 PM	0	0	0	0	0	0	0	0	0	0	0	0	0	0	0	0	0	0	0	0	0
05:45 PM	0	1	0	0	1	0	0	0	0	0	0	0	0	0	0	0	0	0	0	0	1
Total	1	3	0	0	4	0	0	0	0	0	0	0	0	0	0	0	1	0	0	1	5
Grand Total	1	5	0	0	6	1	1	0	0	2	0	0	0	0	0	0	2	0	0	2	10
Apprch %	16.7	83.3	0	0		50	50	0	0		0	0	0	0		0	100	0	0		
Total %	10	50	0	0	60	10	10	0	0	20	0	0	0	0	0	0	20	0	0	20	

Start Time	EL CAMINO REAL Southbound				ORTEGA AVE Westbound				EL CAMINO REAL Northbound				DRIVEWAY Eastbound				Int. Total
	Right	Thru	Left	App. Total	Right	Thru	Left	App. Total	Right	Thru	Left	App. Total	Right	Thru	Left	App. Total	
Peak Hour Analysis From 04:00 PM to 05:45 PM - Peak 1 of 1																	
Peak Hour for Entire Intersection Begins at 04:30 PM																	
04:30 PM	0	0	0	0	1	0	0	1	0	0	0	0	0	1	0	1	2
04:45 PM	0	0	0	0	0	0	0	0	0	0	0	0	0	0	0	0	0
05:00 PM	1	0	0	1	0	0	0	0	0	0	0	0	0	0	0	0	1
05:15 PM	0	2	0	2	0	0	0	0	0	0	0	0	0	1	0	1	3
Total Volume	1	2	0	3	1	0	0	1	0	0	0	0	0	2	0	2	6
% App. Total	33.3	66.7	0		100	0	0		0	0	0		0	100	0		
PHF	.250	.250	.000	.375	.250	.000	.000	.250	.000	.000	.000	.000	.000	.500	.000	.500	.500

Traffic Data Service

San Jose, CA
 (408) 622-4787
 tdsbay@cs.com

File Name : 5PM FINAL
 Site Code : 00000005
 Start Date : 4/27/2021
 Page No : 2

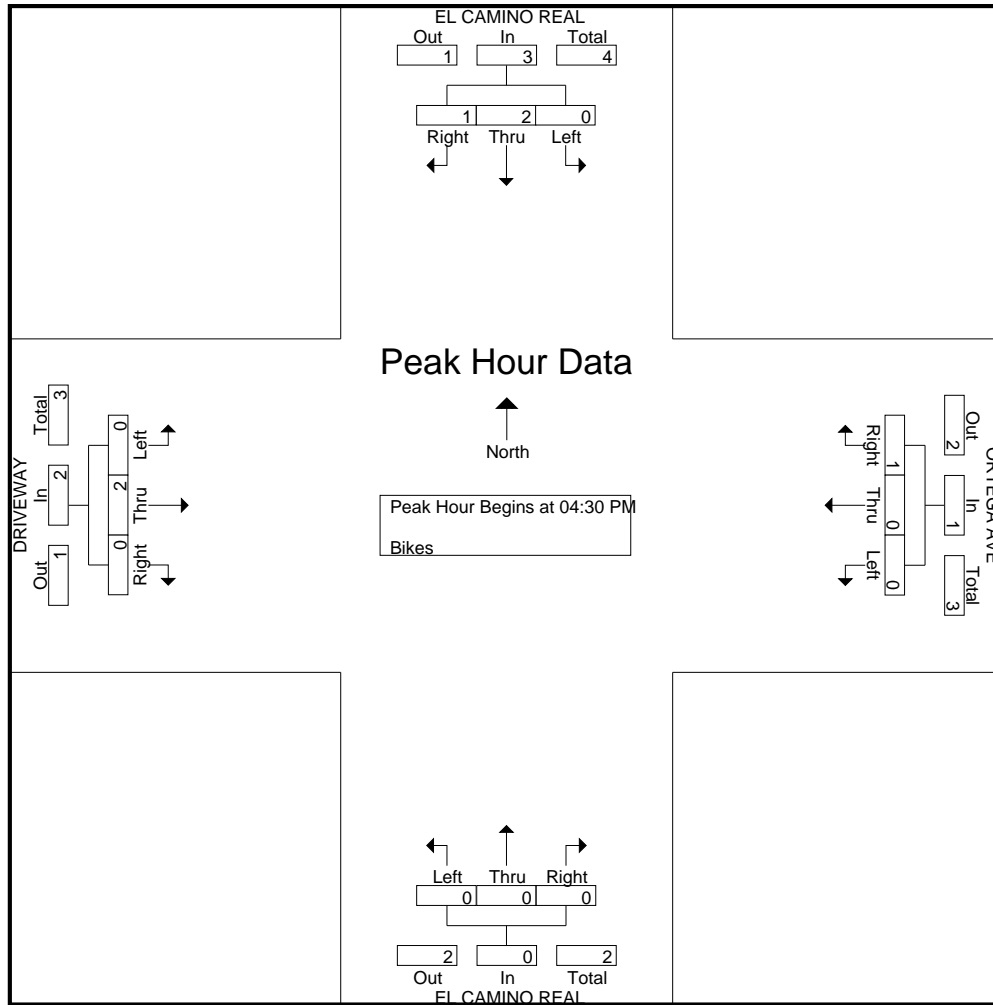

Traffic Data Service

San Jose, CA
(408) 622-4787
tdsbay@cs.com

File Name : 6AM FINAL
 Site Code : 00000006
 Start Date : 4/27/2021
 Page No : 1

Groups Printed- Lights - Buses - Trucks

Start Time	EL CAMINO REAL Southbound					RENGSTORFF AVE Westbound					EL CAMINO REAL Northbound					DRIVEWAY Eastbound					Int. Total
	Right	Thru	Left	Peds	App. Total	Right	Thru	Left	Peds	App. Total	Right	Thru	Left	Peds	App. Total	Right	Thru	Left	Peds	App. Total	
07:00 AM	0	58	5	3	66	12	0	15	0	27	4	117	5	0	126	0	0	0	1	1	220
07:15 AM	0	54	4	1	59	26	0	28	0	54	14	156	3	0	173	0	0	0	0	0	286
07:30 AM	0	107	10	1	118	21	0	28	0	49	23	145	2	0	170	0	0	0	1	1	338
07:45 AM	1	99	5	4	109	22	0	38	0	60	18	204	7	0	229	0	0	0	2	2	400
Total	1	318	24	9	352	81	0	109	0	190	59	622	17	0	698	0	0	0	4	4	1244
08:00 AM	0	137	7	1	145	25	1	60	0	86	34	197	12	0	243	0	0	0	1	1	475
08:15 AM	0	148	8	3	159	20	0	56	2	78	31	189	8	0	228	0	0	0	4	4	469
08:30 AM	0	153	13	2	168	27	0	36	0	63	37	233	3	0	273	0	0	0	3	3	507
08:45 AM	0	140	2	3	145	27	0	43	1	71	37	237	5	0	279	0	0	0	5	5	500
Total	0	578	30	9	617	99	1	195	3	298	139	856	28	0	1023	0	0	0	13	13	1951
Grand Total	1	896	54	18	969	180	1	304	3	488	198	1478	45	0	1721	0	0	0	17	17	3195
Apprch %	0.1	92.5	5.6	1.9		36.9	0.2	62.3	0.6		11.5	85.9	2.6	0		0	0	0	100		
Total %	0	28	1.7	0.6	30.3	5.6	0	9.5	0.1	15.3	6.2	46.3	1.4	0	53.9	0	0	0	0.5	0.5	
Lights	1	849	51	18	919	175	1	299	3	478	192	1427	43	0	1662	0	0	0	17	17	3076
% Lights	100	94.8	94.4	100	94.8	97.2	100	98.4	100	98	97	96.5	95.6	0	96.6	0	0	0	100	100	96.3
Buses	0	19	0	0	19	1	0	2	0	3	0	19	0	0	19	0	0	0	0	0	41
% Buses	0	2.1	0	0	2	0.6	0	0.7	0	0.6	0	1.3	0	0	1.1	0	0	0	0	0	1.3
Trucks	0	28	3	0	31	4	0	3	0	7	6	32	2	0	40	0	0	0	0	0	78
% Trucks	0	3.1	5.6	0	3.2	2.2	0	1	0	1.4	3	2.2	4.4	0	2.3	0	0	0	0	0	2.4

Start Time	EL CAMINO REAL Southbound				RENGSTORFF AVE Westbound				EL CAMINO REAL Northbound				DRIVEWAY Eastbound				Int. Total
	Right	Thru	Left	App. Total	Right	Thru	Left	App. Total	Right	Thru	Left	App. Total	Right	Thru	Left	App. Total	
Peak Hour Analysis From 07:00 AM to 08:45 AM - Peak 1 of 1																	
Peak Hour for Entire Intersection Begins at 08:00 AM																	
08:00 AM	0	137	7	144	25	1	60	86	34	197	12	243	0	0	0	0	473
08:15 AM	0	148	8	156	20	0	56	76	31	189	8	228	0	0	0	0	460
08:30 AM	0	153	13	166	27	0	36	63	37	233	3	273	0	0	0	0	502
08:45 AM	0	140	2	142	27	0	43	70	37	237	5	279	0	0	0	0	491
Total Volume	0	578	30	608	99	1	195	295	139	856	28	1023	0	0	0	0	1926
% App. Total	0	95.1	4.9		33.6	0.3	66.1		13.6	83.7	2.7		0	0	0		
PHF	.000	.944	.577	.916	.917	.250	.813	.858	.939	.903	.583	.917	.000	.000	.000	.000	.959

Traffic Data Service

San Jose, CA
 (408) 622-4787
 tdsbay@cs.com

File Name : 6AM FINAL
 Site Code : 00000006
 Start Date : 4/27/2021
 Page No : 2

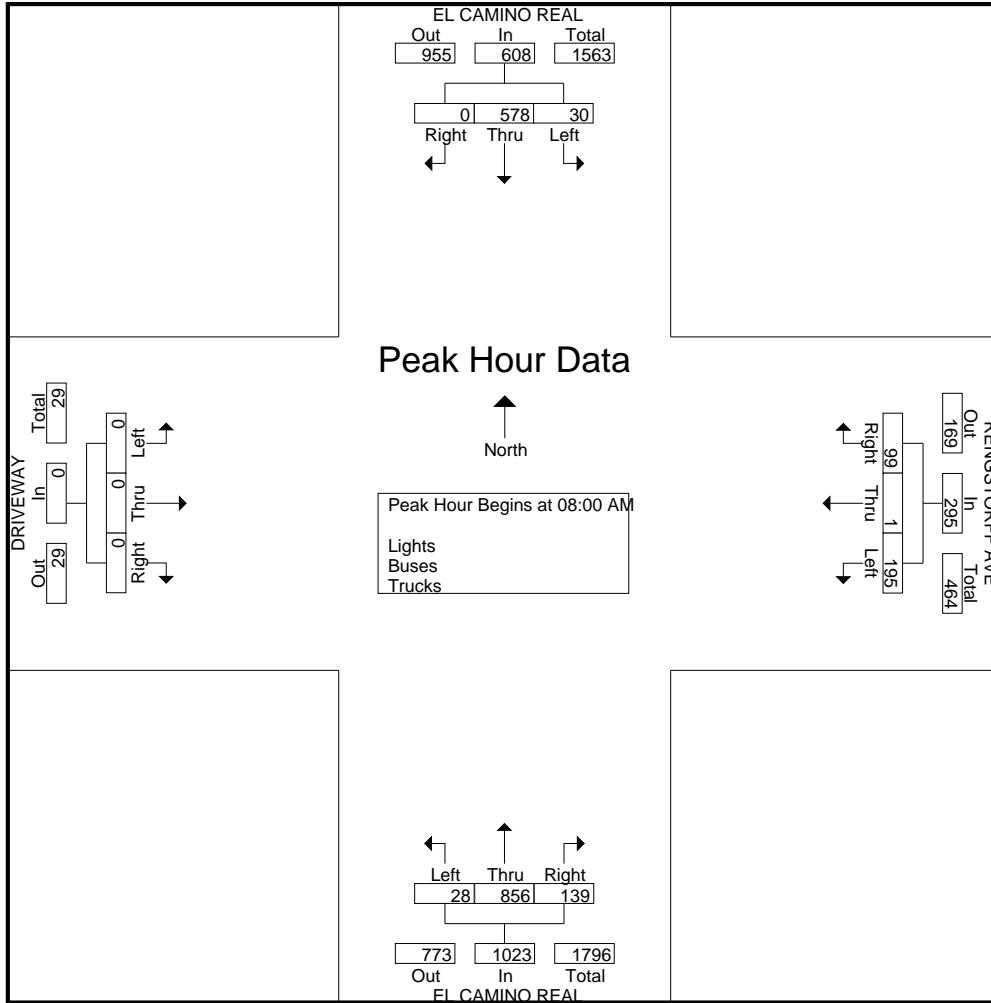

Traffic Data Service

San Jose, CA
 (408) 622-4787
 tdsbay@cs.com

File Name : 6AM FINAL
 Site Code : 00000006
 Start Date : 4/27/2021
 Page No : 1

Groups Printed- Bikes

Start Time	EL CAMINO REAL Southbound					RENGSTORFF AVE Westbound					EL CAMINO REAL Northbound					DRIVEWAY Eastbound					Int. Total
	Right	Thru	Left	Peds	App. Total	Right	Thru	Left	Peds	App. Total	Right	Thru	Left	Peds	App. Total	Right	Thru	Left	Peds	App. Total	
07:00 AM	0	0	0	0	0	0	1	0	0	1	0	0	0	0	0	0	0	0	0	0	0
07:15 AM	0	0	0	0	0	0	0	0	0	0	0	0	0	0	0	0	0	0	0	0	0
07:30 AM	0	1	0	0	1	0	0	0	0	0	0	1	0	0	1	0	0	0	0	0	0
07:45 AM	0	0	1	0	1	0	1	1	0	2	0	2	0	0	2	0	0	0	0	0	0
Total	0	1	1	0	2	0	2	1	0	3	0	3	0	0	3	0	0	0	0	0	0
08:00 AM	0	0	1	0	1	1	0	0	0	1	1	0	0	0	1	0	0	0	0	0	0
08:15 AM	0	0	0	0	0	0	0	0	0	0	0	0	0	0	0	0	0	0	0	0	0
08:30 AM	0	0	0	0	0	0	0	0	0	0	0	0	0	0	0	0	0	0	0	0	0
08:45 AM	0	0	0	0	0	0	0	0	0	0	0	1	0	0	1	0	0	0	0	0	0
Total	0	0	1	0	1	1	0	0	0	1	1	1	0	0	2	0	0	0	0	0	0
Grand Total	0	1	2	0	3	1	2	1	0	4	1	4	0	0	5	0	0	0	0	0	0
Apprch %	0	33.3	66.7	0		25	50	25	0		20	80	0	0		0	0	0	0		
Total %	0	8.3	16.7	0	25	8.3	16.7	8.3	0	33.3	8.3	33.3	0	0	41.7	0	0	0	0	0	

Start Time	EL CAMINO REAL Southbound				RENGSTORFF AVE Westbound				EL CAMINO REAL Northbound				DRIVEWAY Eastbound				Int. Total
	Right	Thru	Left	App. Total	Right	Thru	Left	App. Total	Right	Thru	Left	App. Total	Right	Thru	Left	App. Total	
Peak Hour Analysis From 07:00 AM to 08:45 AM - Peak 1 of 1																	
Peak Hour for Entire Intersection Begins at 07:15 AM																	
07:15 AM	0	0	0	0	0	0	0	0	0	0	0	0	0	0	0	0	0
07:30 AM	0	1	0	1	0	0	0	0	0	1	0	1	0	0	0	0	0
07:45 AM	0	0	1	1	0	1	1	2	0	2	0	2	0	0	0	0	0
08:00 AM	0	0	1	1	1	0	0	1	1	0	0	1	0	0	0	0	0
Total Volume	0	1	2	3	1	1	1	3	1	3	0	4	0	0	0	0	10
% App. Total	0	33.3	66.7		33.3	33.3	33.3		25	75	0		0	0	0		
PHF	.000	.250	.500	.750	.250	.250	.250	.375	.250	.375	.000	.500	.000	.000	.000	.000	.500

Traffic Data Service

San Jose, CA
 (408) 622-4787
 tdsbay@cs.com

File Name : 6AM FINAL
 Site Code : 00000006
 Start Date : 4/27/2021
 Page No : 2

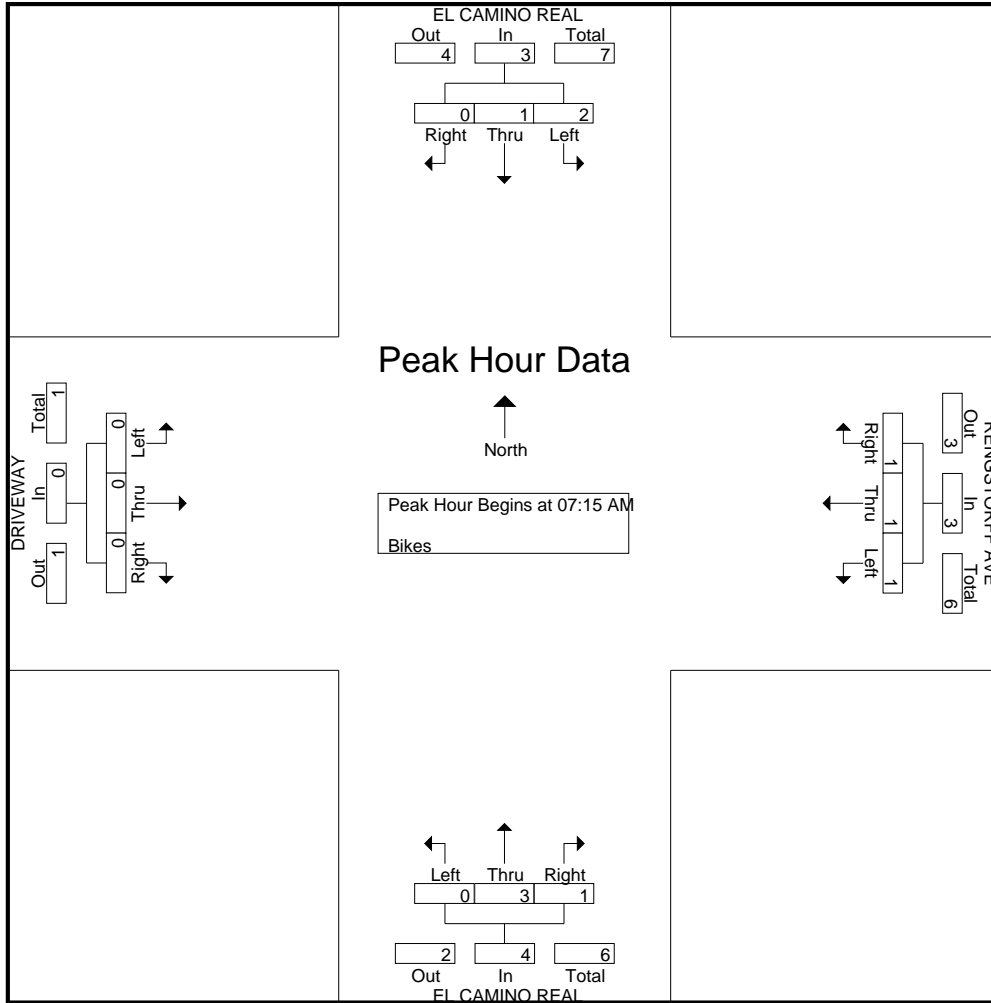

Traffic Data Service

San Jose, CA
 (408) 622-4787
 tdsbay@cs.com

File Name : 6PM FINAL
 Site Code : 00000006
 Start Date : 4/27/2021
 Page No : 1

Groups Printed- Lights - Buses - Trucks

Start Time	EL CAMINO REAL Southbound					RENGSTORFF AVE Westbound					EL CAMINO REAL Northbound					DRIVEWAY Eastbound					Int. Total
	Right	Thru	Left	Peds	App. Total	Right	Thru	Left	Peds	App. Total	Right	Thru	Left	Peds	App. Total	Right	Thru	Left	Peds	App. Total	
04:00 PM	0	198	25	3	226	20	0	52	8	80	46	198	7	0	251	1	0	0	4	5	562
04:15 PM	0	231	21	0	252	25	0	49	0	74	44	199	12	0	255	0	0	0	7	7	588
04:30 PM	0	224	35	5	264	27	0	62	3	92	59	187	25	1	272	0	0	1	6	7	635
04:45 PM	0	246	27	0	273	17	0	37	1	55	57	224	14	0	295	0	0	0	7	7	630
Total	0	899	108	8	1015	89	0	200	12	301	206	808	58	1	1073	1	0	1	24	26	2415
05:00 PM	0	275	31	6	312	16	0	57	1	74	48	219	15	0	282	0	0	1	8	9	677
05:15 PM	0	244	25	7	276	22	0	63	1	86	48	200	20	0	268	0	0	0	7	7	637
05:30 PM	0	236	18	2	256	22	0	47	1	70	57	198	13	0	268	0	0	0	6	6	600
05:45 PM	0	224	21	1	246	28	0	49	3	80	45	185	7	0	237	0	0	0	1	1	564
Total	0	979	95	16	1090	88	0	216	6	310	198	802	55	0	1055	0	0	1	22	23	2478
Grand Total	0	1878	203	24	2105	177	0	416	18	611	404	1610	113	1	2128	1	0	2	46	49	4893
Apprch %	0	89.2	9.6	1.1		29	0	68.1	2.9		19	75.7	5.3	0		2	0	4.1	93.9		
Total %	0	38.4	4.1	0.5	43	3.6	0	8.5	0.4	12.5	8.3	32.9	2.3	0	43.5	0	0	0	0.9	1	
Lights	0	1846	201	24	2071	177	0	414	18	609	400	1582	112	1	2095	1	0	2	46	49	4824
% Lights	0	98.3	99	100	98.4	100	0	99.5	100	99.7	99	98.3	99.1	100	98.4	100	0	100	100	100	98.6
Buses	0	15	0	0	15	0	0	1	0	1	0	23	0	0	23	0	0	0	0	0	39
% Buses	0	0.8	0	0	0.7	0	0	0.2	0	0.2	0	1.4	0	0	1.1	0	0	0	0	0	0.8
Trucks	0	17	2	0	19	0	0	1	0	1	4	5	1	0	10	0	0	0	0	0	30
% Trucks	0	0.9	1	0	0.9	0	0	0.2	0	0.2	1	0.3	0.9	0	0.5	0	0	0	0	0	0.6

Start Time	EL CAMINO REAL Southbound				RENGSTORFF AVE Westbound				EL CAMINO REAL Northbound				DRIVEWAY Eastbound				Int. Total
	Right	Thru	Left	App. Total	Right	Thru	Left	App. Total	Right	Thru	Left	App. Total	Right	Thru	Left	App. Total	
Peak Hour Analysis From 04:00 PM to 05:45 PM - Peak 1 of 1																	
Peak Hour for Entire Intersection Begins at 04:30 PM																	
04:30 PM	0	224	35	259	27	0	62	89	59	187	25	271	0	0	1	1	620
04:45 PM	0	246	27	273	17	0	37	54	57	224	14	295	0	0	0	0	622
05:00 PM	0	275	31	306	16	0	57	73	48	219	15	282	0	0	1	1	662
05:15 PM	0	244	25	269	22	0	63	85	48	200	20	268	0	0	0	0	622
Total Volume	0	989	118	1107	82	0	219	301	212	830	74	1116	0	0	2	2	2526
% App. Total	0	89.3	10.7		27.2	0	72.8		19	74.4	6.6		0	0	100		
PHF	.000	.899	.843	.904	.759	.000	.869	.846	.898	.926	.740	.946	.000	.000	.500	.500	.954

Traffic Data Service

San Jose, CA
 (408) 622-4787
 tdsbay@cs.com

File Name : 6PM FINAL
 Site Code : 00000006
 Start Date : 4/27/2021
 Page No : 2

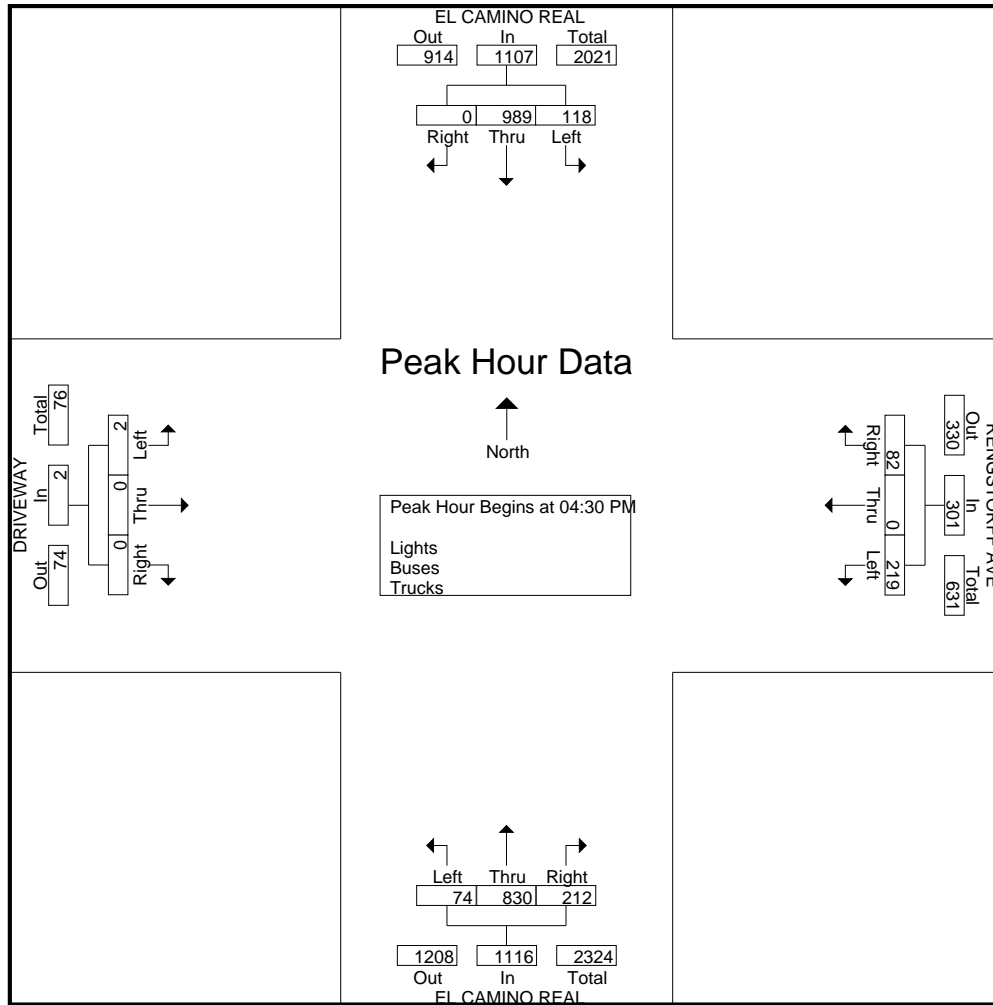

Traffic Data Service

San Jose, CA
 (408) 622-4787
 tdsbay@cs.com

File Name : 6PM FINAL
 Site Code : 00000006
 Start Date : 4/27/2021
 Page No : 1

Groups Printed- Bikes

Start Time	EL CAMINO REAL Southbound					RENGSTORFF AVE Westbound					EL CAMINO REAL Northbound					DRIVEWAY Eastbound					Int. Total
	Right	Thru	Left	Peds	App. Total	Right	Thru	Left	Peds	App. Total	Right	Thru	Left	Peds	App. Total	Right	Thru	Left	Peds	App. Total	
04:00 PM	0	2	0	0	2	0	0	0	0	0	0	0	0	0	0	0	0	0	0	0	0
04:15 PM	0	0	0	0	0	0	1	0	0	1	0	0	0	0	0	0	0	0	0	0	0
04:30 PM	0	1	0	0	1	0	0	0	0	0	0	0	0	0	0	0	0	0	0	0	0
04:45 PM	0	0	0	0	0	0	0	0	0	0	0	0	0	0	0	0	0	0	0	0	0
Total	0	3	0	0	3	0	1	0	0	1	0	0	0	0	0	0	0	0	0	0	4
05:00 PM	0	0	0	0	0	0	0	0	0	0	0	0	0	0	0	0	0	0	0	0	0
05:15 PM	0	1	0	0	1	0	0	0	0	0	0	0	0	0	0	0	0	0	0	0	1
05:30 PM	0	0	0	0	0	0	0	0	0	0	0	0	0	0	0	0	0	0	0	0	0
05:45 PM	0	0	0	0	0	0	0	0	0	0	0	0	0	0	0	0	0	0	0	0	0
Total	0	1	0	0	1	0	0	0	0	0	0	0	0	0	0	0	0	0	0	0	1
Grand Total	0	4	0	0	4	0	1	0	0	1	0	0	0	0	0	0	0	0	0	0	5
Apprch %	0	100	0	0		0	100	0	0		0	0	0	0		0	0	0	0		
Total %	0	80	0	0	80	0	20	0	0	20	0	0	0	0	0	0	0	0	0	0	

Start Time	EL CAMINO REAL Southbound				RENGSTORFF AVE Westbound				EL CAMINO REAL Northbound				DRIVEWAY Eastbound				Int. Total
	Right	Thru	Left	App. Total	Right	Thru	Left	App. Total	Right	Thru	Left	App. Total	Right	Thru	Left	App. Total	
Peak Hour Analysis From 04:00 PM to 05:45 PM - Peak 1 of 1																	
Peak Hour for Entire Intersection Begins at 04:00 PM																	
04:00 PM	0	2	0	2	0	0	0	0	0	0	0	0	0	0	0	0	2
04:15 PM	0	0	0	0	0	1	0	1	0	0	0	0	0	0	0	0	1
04:30 PM	0	1	0	1	0	0	0	0	0	0	0	0	0	0	0	0	1
04:45 PM	0	0	0	0	0	0	0	0	0	0	0	0	0	0	0	0	0
Total Volume	0	3	0	3	0	1	0	1	0	0	0	0	0	0	0	0	4
% App. Total	0	100	0		0	100	0		0	0	0		0	0	0		
PHF	.000	.375	.000	.375	.000	.250	.000	.250	.000	.000	.000	.000	.000	.000	.000	.000	.500

Traffic Data Service

San Jose, CA
 (408) 622-4787
 tdsbay@cs.com

File Name : 6PM FINAL
 Site Code : 00000006
 Start Date : 4/27/2021
 Page No : 2

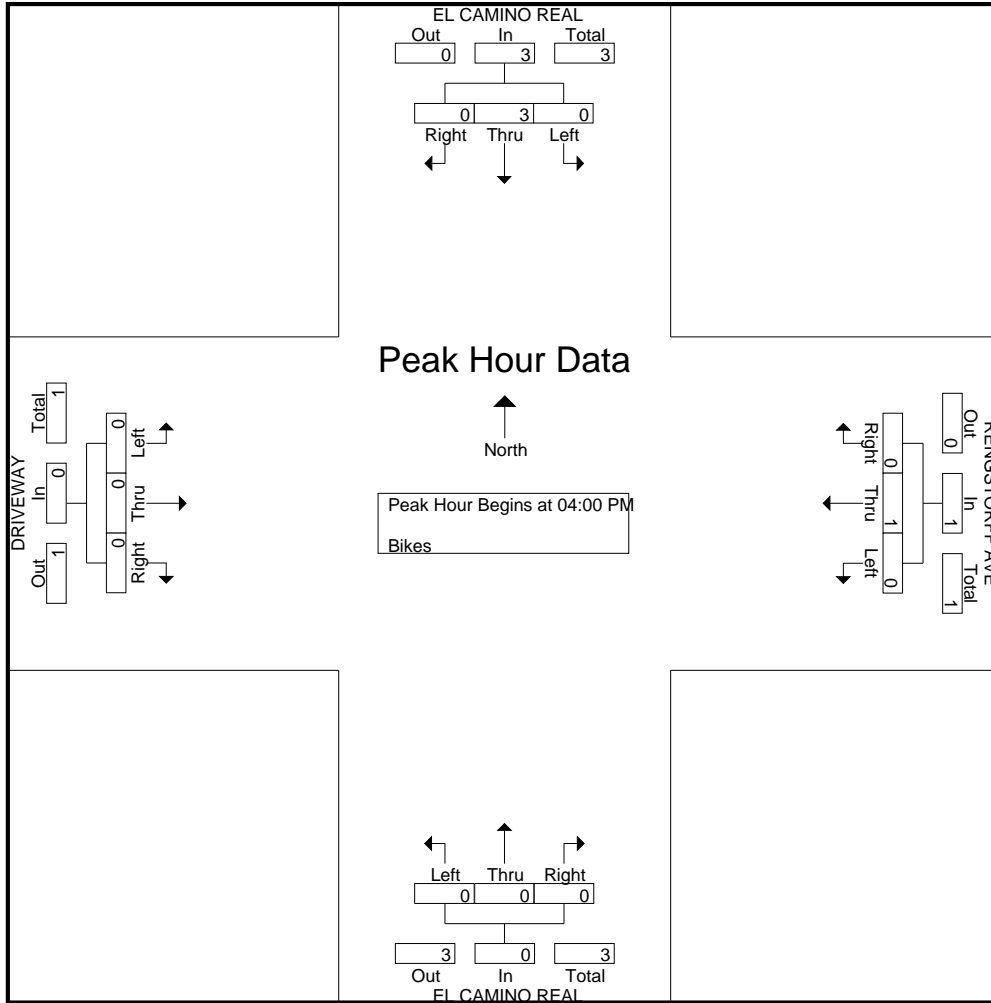

Traffic Data Service

San Jose, CA
 (408) 622-4787
 tdsbay@cs.com

File Name : 7AM FINAL
 Site Code : 00000007
 Start Date : 4/27/2021
 Page No : 1

Groups Printed- Lights - Buses - Trucks

Start Time	FAYETTE DR Southbound					SAN ANTONIO RD Westbound					DRIVEWAY Northbound					SAN ANTONIO RD Eastbound					Int. Total
	Right	Thru	Left	Peds	App. Total	Right	Thru	Left	Peds	App. Total	Right	Thru	Left	Peds	App. Total	Right	Thru	Left	Peds	App. Total	
07:00 AM	1	3	3	2	9	2	80	14	0	96	3	1	6	2	12	1	32	0	3	36	153
07:15 AM	2	1	2	4	9	5	88	15	2	110	2	2	2	3	9	3	49	2	4	58	186
07:30 AM	3	2	8	4	17	0	124	10	1	135	6	0	2	0	8	3	56	9	4	72	232
07:45 AM	6	3	4	2	15	4	165	16	0	185	8	1	7	2	18	3	95	2	0	100	318
Total	12	9	17	12	50	11	457	55	3	526	19	4	17	7	47	10	232	13	11	266	889
08:00 AM	5	2	5	4	16	6	161	11	0	178	6	0	6	1	13	5	114	1	7	127	334
08:15 AM	7	5	3	1	16	3	144	11	1	159	5	1	2	3	11	2	108	5	2	117	303
08:30 AM	2	4	6	3	15	4	147	18	2	171	9	1	8	3	21	7	127	8	5	147	354
08:45 AM	4	4	7	1	16	8	129	17	1	155	11	1	5	3	20	4	100	9	5	118	309
Total	18	15	21	9	63	21	581	57	4	663	31	3	21	10	65	18	449	23	19	509	1300
Grand Total	30	24	38	21	113	32	1038	112	7	1189	50	7	38	17	112	28	681	36	30	775	2189
Apprch %	26.5	21.2	33.6	18.6		2.7	87.3	9.4	0.6		44.6	6.2	33.9	15.2		3.6	87.9	4.6	3.9		
Total %	1.4	1.1	1.7	1	5.2	1.5	47.4	5.1	0.3	54.3	2.3	0.3	1.7	0.8	5.1	1.3	31.1	1.6	1.4	35.4	
Lights	29	23	35	21	108	29	988	107	7	1131	48	7	37	17	109	27	653	36	30	746	2094
% Lights	96.7	95.8	92.1	100	95.6	90.6	95.2	95.5	100	95.1	96	100	97.4	100	97.3	96.4	95.9	100	100	96.3	95.7
Buses	0	0	0	0	0	0	4	1	0	5	0	0	0	0	0	0	9	0	0	9	14
% Buses	0	0	0	0	0	0	0.4	0.9	0	0.4	0	0	0	0	0	0	1.3	0	0	1.2	0.6
Trucks	1	1	3	0	5	3	46	4	0	53	2	0	1	0	3	1	19	0	0	20	81
% Trucks	3.3	4.2	7.9	0	4.4	9.4	4.4	3.6	0	4.5	4	0	2.6	0	2.7	3.6	2.8	0	0	2.6	3.7

Start Time	FAYETTE DR Southbound				SAN ANTONIO RD Westbound				DRIVEWAY Northbound				SAN ANTONIO RD Eastbound				Int. Total
	Right	Thru	Left	App. Total	Right	Thru	Left	App. Total	Right	Thru	Left	App. Total	Right	Thru	Left	App. Total	
Peak Hour Analysis From 07:00 AM to 08:45 AM - Peak 1 of 1																	
Peak Hour for Entire Intersection Begins at 07:45 AM																	
07:45 AM	6	3	4	13	4	165	16	185	8	1	7	16	3	95	2	100	314
08:00 AM	5	2	5	12	6	161	11	178	6	0	6	12	5	114	1	120	322
08:15 AM	7	5	3	15	3	144	11	158	5	1	2	8	2	108	5	115	296
08:30 AM	2	4	6	12	4	147	18	169	9	1	8	18	7	127	8	142	341
Total Volume	20	14	18	52	17	617	56	690	28	3	23	54	17	444	16	477	1273
% App. Total	38.5	26.9	34.6		2.5	89.4	8.1		51.9	5.6	42.6		3.6	93.1	3.4		
PHF	.714	.700	.750	.867	.708	.935	.778	.932	.778	.750	.719	.750	.607	.874	.500	.840	.933

Traffic Data Service

San Jose, CA
 (408) 622-4787
 tdsbay@cs.com

File Name : 7AM FINAL
 Site Code : 00000007
 Start Date : 4/27/2021
 Page No : 2

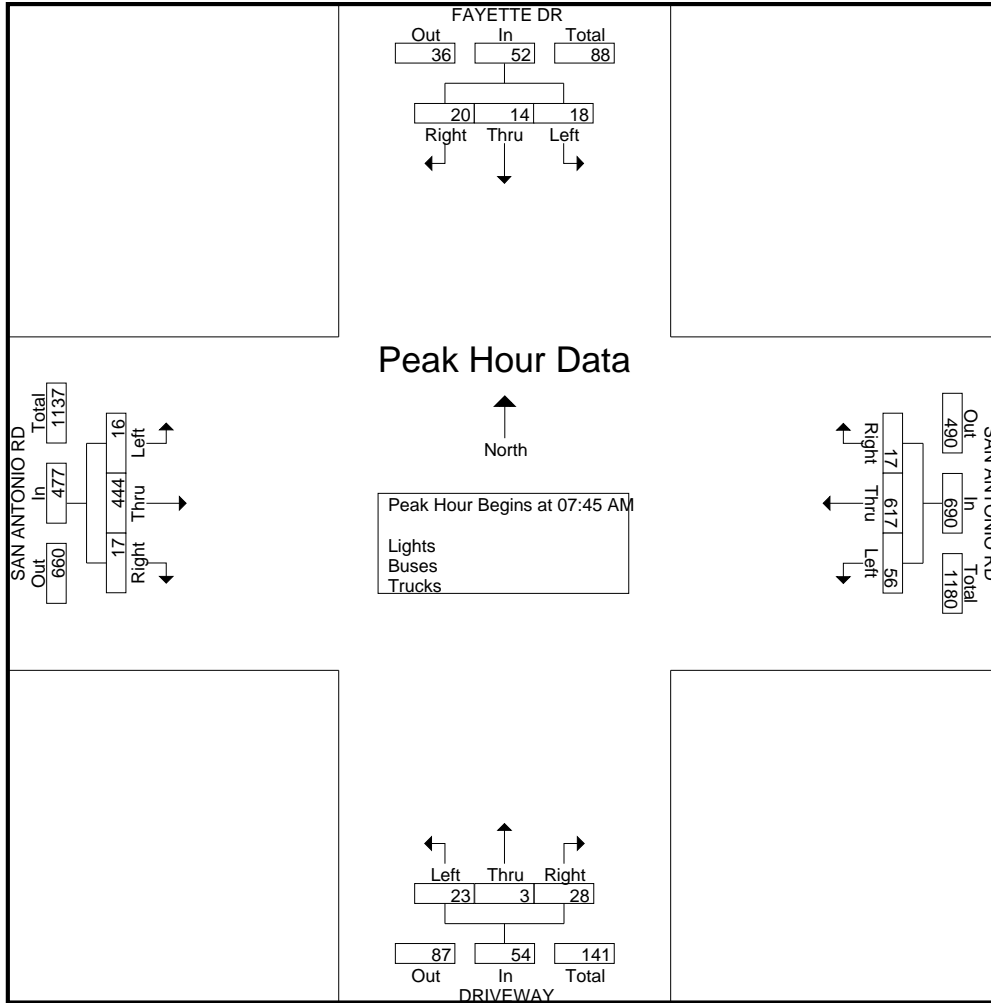

Traffic Data Service

San Jose, CA
 (408) 622-4787
 tdsbay@cs.com

File Name : 7AM FINAL
 Site Code : 00000007
 Start Date : 4/27/2021
 Page No : 1

Groups Printed- Bikes

Start Time	FAYETTE DR Southbound					SAN ANTONIO RD Westbound					DRIVEWAY Northbound					SAN ANTONIO RD Eastbound					Int. Total
	Right	Thru	Left	Peds	App. Total	Right	Thru	Left	Peds	App. Total	Right	Thru	Left	Peds	App. Total	Right	Thru	Left	Peds	App. Total	
07:00 AM	0	0	0	0	0	0	0	0	0	0	0	0	0	0	0	1	0	0	0	0	1
07:15 AM	0	0	0	0	0	0	0	0	0	0	0	0	1	0	1	0	0	0	0	0	0
07:30 AM	0	0	0	0	0	1	1	0	0	2	1	0	0	0	1	0	0	0	0	0	0
07:45 AM	0	0	0	0	0	0	0	0	0	0	0	0	0	0	0	0	1	0	0	1	1
Total	0	0	0	0	0	1	1	0	0	2	1	0	1	0	2	1	1	0	0	2	6
08:00 AM	1	1	0	0	2	0	1	1	0	2	0	1	0	0	1	0	0	1	0	1	6
08:15 AM	0	2	0	0	2	1	0	0	0	1	0	1	0	0	1	0	0	0	0	0	4
08:30 AM	0	1	0	0	1	0	1	0	0	1	0	1	1	0	2	1	1	0	0	2	6
08:45 AM	0	0	0	0	0	0	0	0	0	0	0	0	0	0	0	0	0	0	0	0	0
Total	1	4	0	0	5	1	2	1	0	4	0	3	1	0	4	1	1	1	0	3	16
Grand Total	1	4	0	0	5	2	3	1	0	6	1	3	2	0	6	2	2	1	0	5	22
Apprch %	20	80	0	0		33.3	50	16.7	0		16.7	50	33.3	0		40	40	20	0		
Total %	4.5	18.2	0	0	22.7	9.1	13.6	4.5	0	27.3	4.5	13.6	9.1	0	27.3	9.1	9.1	4.5	0	22.7	

Start Time	FAYETTE DR Southbound					SAN ANTONIO RD Westbound					DRIVEWAY Northbound					SAN ANTONIO RD Eastbound					Int. Total
	Right	Thru	Left	Peds	App. Total	Right	Thru	Left	Peds	App. Total	Right	Thru	Left	Peds	App. Total	Right	Thru	Left	Peds	App. Total	
07:45 AM	0	0	0	0	0	0	0	0	0	0	0	0	0	0	0	0	1	0	0	1	1
08:00 AM	1	1	0	0	2	0	1	1	0	2	0	1	0	0	1	0	0	1	0	1	6
08:15 AM	0	2	0	0	2	1	0	0	0	1	0	1	0	0	1	0	0	0	0	0	4
08:30 AM	0	1	0	0	1	0	1	0	0	1	0	1	1	0	2	1	1	0	0	2	6
Total Volume	1	4	0	0	5	1	2	1	0	4	0	3	1	0	4	1	2	1	0	4	17
% App. Total	20	80	0	0		25	50	25	0		0	75	25	0		25	50	25	0		
PHF	.250	.500	.000	.000	.625	.250	.500	.250	.000	.500	.000	.750	.250	.000	.500	.250	.500	.250	.000	.500	.708

Peak Hour Analysis From 07:00 AM to 08:45 AM - Peak 1 of 1
 Peak Hour for Entire Intersection Begins at 07:45 AM

Traffic Data Service

San Jose, CA
 (408) 622-4787
 tdsbay@cs.com

File Name : 7AM FINAL
 Site Code : 00000007
 Start Date : 4/27/2021
 Page No : 2

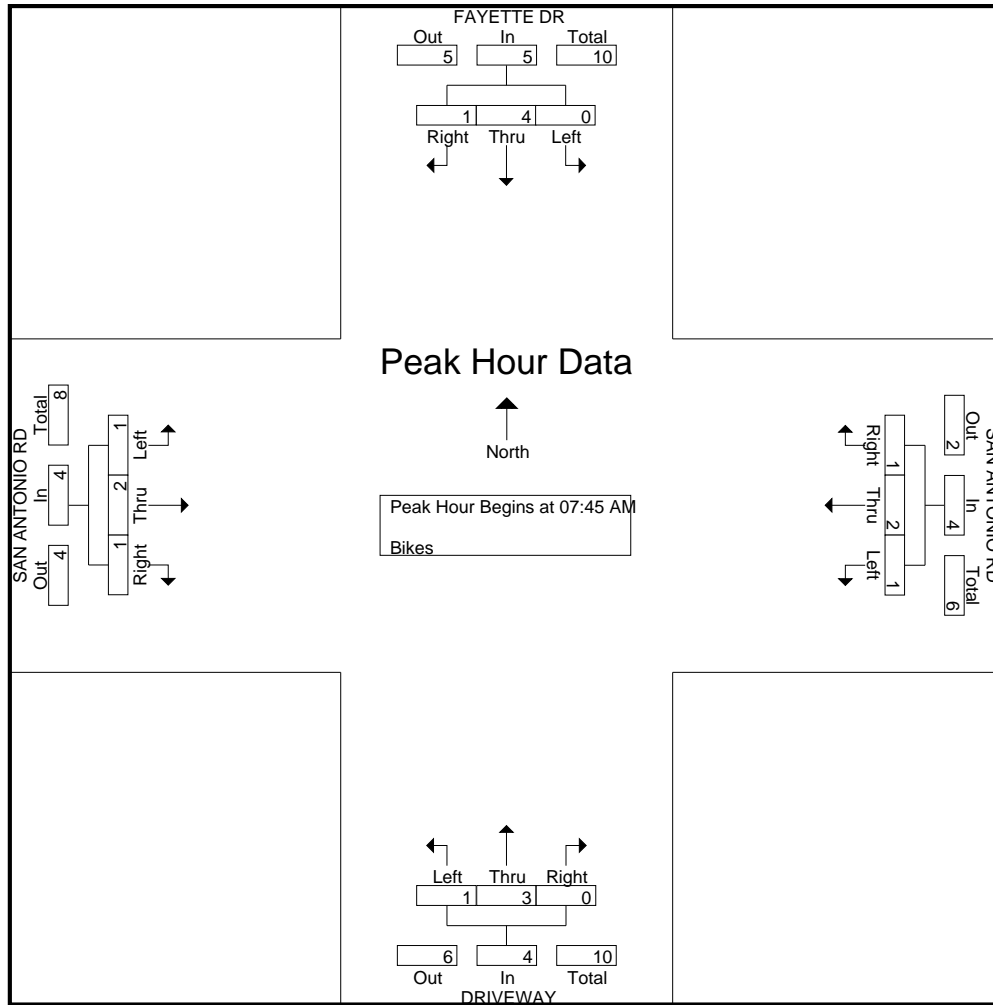

Traffic Data Service

San Jose, CA
 (408) 622-4787
 tdsbay@cs.com

File Name : 7PM FINAL
 Site Code : 00000007
 Start Date : 4/27/2021
 Page No : 1

Groups Printed- Lights - Buses - Trucks

Start Time	FAYETTE DR Southbound					SAN ANTONIO RD Westbound					DRIVEWAY Northbound					SAN ANTONIO RD Eastbound					Int. Total
	Right	Thru	Left	Peds	App. Total	Right	Thru	Left	Peds	App. Total	Right	Thru	Left	Peds	App. Total	Right	Thru	Left	Peds	App. Total	
04:00 PM	3	4	7	1	15	7	145	29	3	184	11	8	7	2	28	5	148	9	5	167	394
04:15 PM	7	1	6	3	17	5	138	29	6	178	8	4	11	2	25	10	141	8	13	172	392
04:30 PM	6	3	9	5	23	8	168	20	3	199	13	2	3	2	20	7	139	6	7	159	401
04:45 PM	2	9	11	3	25	3	137	36	0	176	16	5	14	0	35	13	152	8	3	176	412
Total	18	17	33	12	80	23	588	114	12	737	48	19	35	6	108	35	580	31	28	674	1599
05:00 PM	7	4	7	3	21	5	162	26	7	200	15	3	9	2	29	12	143	7	5	167	417
05:15 PM	5	2	14	8	29	4	147	25	4	180	11	3	2	2	18	2	140	5	4	151	378
05:30 PM	3	1	14	1	19	4	127	32	5	168	9	4	5	7	25	11	136	10	4	161	373
05:45 PM	4	7	8	6	25	7	148	28	5	188	11	1	3	1	16	3	103	7	12	125	354
Total	19	14	43	18	94	20	584	111	21	736	46	11	19	12	88	28	522	29	25	604	1522
Grand Total	37	31	76	30	174	43	1172	225	33	1473	94	30	54	18	196	63	1102	60	53	1278	3121
Apprch %	21.3	17.8	43.7	17.2		2.9	79.6	15.3	2.2		4.8	15.3	27.6	9.2		4.9	86.2	4.7	4.1		
Total %	1.2	1	2.4	1	5.6	1.4	37.6	7.2	1.1	47.2	3	1	1.7	0.6	6.3	2	35.3	1.9	1.7	40.9	
Lights	36	31	76	30	173	43	1171	225	33	1472	93	30	54	18	195	63	1082	60	53	1258	3098
% Lights	97.3	100	100	100	99.4	100	99.9	100	100	99.9	98.9	100	100	100	99.5	100	98.2	100	100	98.4	99.3
Buses	0	0	0	0	0	0	0	0	0	0	0	0	0	0	0	0	8	0	0	8	8
% Buses	0	0	0	0	0	0	0	0	0	0	0	0	0	0	0	0	0.7	0	0	0.6	0.3
Trucks	1	0	0	0	1	0	1	0	0	1	1	0	0	0	1	0	12	0	0	12	15
% Trucks	2.7	0	0	0	0.6	0	0.1	0	0	0.1	1.1	0	0	0	0.5	0	1.1	0	0	0.9	0.5

Start Time	FAYETTE DR Southbound				SAN ANTONIO RD Westbound				DRIVEWAY Northbound				SAN ANTONIO RD Eastbound				Int. Total
	Right	Thru	Left	App. Total	Right	Thru	Left	App. Total	Right	Thru	Left	App. Total	Right	Thru	Left	App. Total	
Peak Hour Analysis From 04:00 PM to 05:45 PM - Peak 1 of 1																	
Peak Hour for Entire Intersection Begins at 04:15 PM																	
04:15 PM	7	1	6	14	5	138	29	172	8	4	11	23	10	141	8	159	368
04:30 PM	6	3	9	18	8	168	20	196	13	2	3	18	7	139	6	152	384
04:45 PM	2	9	11	22	3	137	36	176	16	5	14	35	13	152	8	173	406
05:00 PM	7	4	7	18	5	162	26	193	15	3	9	27	12	143	7	162	400
Total Volume	22	17	33	72	21	605	111	737	52	14	37	103	42	575	29	646	1558
% App. Total	30.6	23.6	45.8		2.8	82.1	15.1		50.5	13.6	35.9		6.5	89	4.5		
PHF	.786	.472	.750	.818	.656	.900	.771	.940	.813	.700	.661	.736	.808	.946	.906	.934	.959

Traffic Data Service

San Jose, CA
 (408) 622-4787
 tdsbay@cs.com

File Name : 7PM FINAL
 Site Code : 00000007
 Start Date : 4/27/2021
 Page No : 2

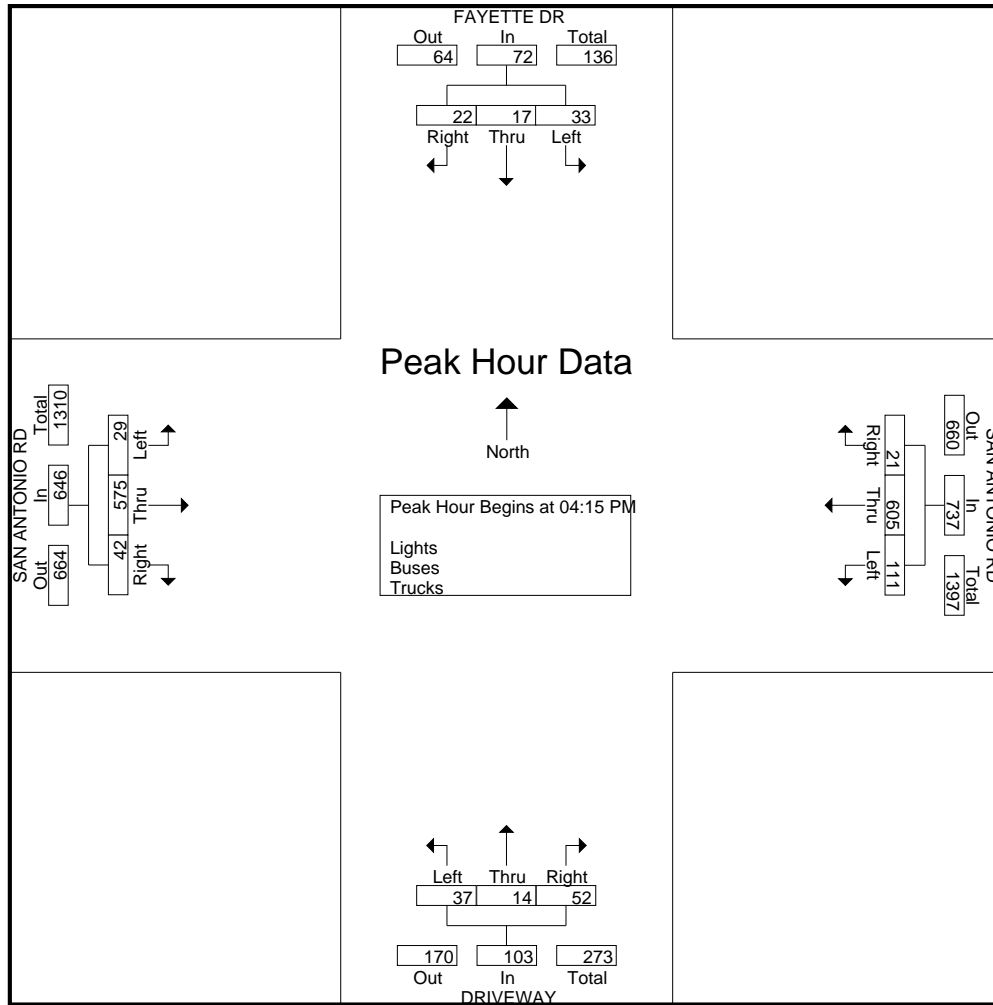

Traffic Data Service

San Jose, CA
 (408) 622-4787
 tdsbay@cs.com

File Name : 7PM FINAL
 Site Code : 00000007
 Start Date : 4/27/2021
 Page No : 1

Groups Printed- Bikes

Start Time	FAYETTE DR Southbound					SAN ANTONIO RD Westbound					DRIVEWAY Northbound					SAN ANTONIO RD Eastbound					Int. Total	
	Right	Thru	Left	Peds	App. Total	Right	Thru	Left	Peds	App. Total	Right	Thru	Left	Peds	App. Total	Right	Thru	Left	Peds	App. Total		
04:00 PM	1	0	0	0	1	0	1	0	0	1	0	0	0	0	0	0	0	0	0	0	0	2
04:15 PM	4	1	0	0	5	0	0	1	0	1	0	0	1	0	1	0	0	0	0	0	0	7
04:30 PM	1	0	0	0	1	1	0	0	0	1	0	0	0	0	0	1	0	0	0	0	1	3
04:45 PM	0	0	0	0	0	0	0	0	0	0	0	0	0	0	0	0	0	1	0	0	1	1
Total	6	1	0	0	7	1	1	1	0	3	0	0	1	0	1	1	0	1	0	2	13	
05:00 PM	0	1	0	0	1	1	3	0	0	4	0	0	0	0	0	0	0	0	0	0	0	5
05:15 PM	2	0	0	0	2	0	0	0	0	0	0	2	0	0	2	0	0	0	0	0	0	4
05:30 PM	2	1	0	0	3	0	0	0	0	0	0	1	0	0	1	0	0	0	0	0	0	4
05:45 PM	0	1	0	0	1	0	1	0	0	1	0	0	0	0	0	0	0	0	0	0	0	2
Total	4	3	0	0	7	1	4	0	0	5	0	3	0	0	3	0	0	0	0	0	0	15
Grand Total	10	4	0	0	14	2	5	1	0	8	0	3	1	0	4	1	0	1	0	2	28	
Apprch %	71.4	28.6	0	0		25	62.5	12.5	0		0	75	25	0		50	0	50	0			
Total %	35.7	14.3	0	0	50	7.1	17.9	3.6	0	28.6	0	10.7	3.6	0	14.3	3.6	0	3.6	0	7.1		

Start Time	FAYETTE DR Southbound					SAN ANTONIO RD Westbound					DRIVEWAY Northbound					SAN ANTONIO RD Eastbound					Int. Total
	Right	Thru	Left	Peds	App. Total	Right	Thru	Left	Peds	App. Total	Right	Thru	Left	Peds	App. Total	Right	Thru	Left	Peds	App. Total	
Peak Hour Analysis From 04:00 PM to 05:45 PM - Peak 1 of 1																					
Peak Hour for Entire Intersection Begins at 04:15 PM																					
04:15 PM	4	1	0	0	5	0	0	1	0	1	0	0	1	0	1	0	0	0	0	0	7
04:30 PM	1	0	0	0	1	1	0	0	0	1	0	0	0	0	0	1	0	0	0	1	3
04:45 PM	0	0	0	0	0	0	0	0	0	0	0	0	0	0	0	0	0	1	0	1	1
05:00 PM	0	1	0	0	1	1	3	0	0	4	0	0	0	0	0	0	0	0	0	0	5
Total Volume	5	2	0	0	7	2	3	1	0	6	0	0	1	0	1	1	0	1	0	2	16
% App. Total	71.4	28.6	0	0		33.3	50	16.7	0		0	0	100	0		50	0	50	0		
PHF	.313	.500	.000	.350		.500	.250	.250	.375		.000	.000	.250	.250		.250	.000	.250	.500		.571

Traffic Data Service

San Jose, CA
 (408) 622-4787
 tdsbay@cs.com

File Name : 7PM FINAL
 Site Code : 00000007
 Start Date : 4/27/2021
 Page No : 2

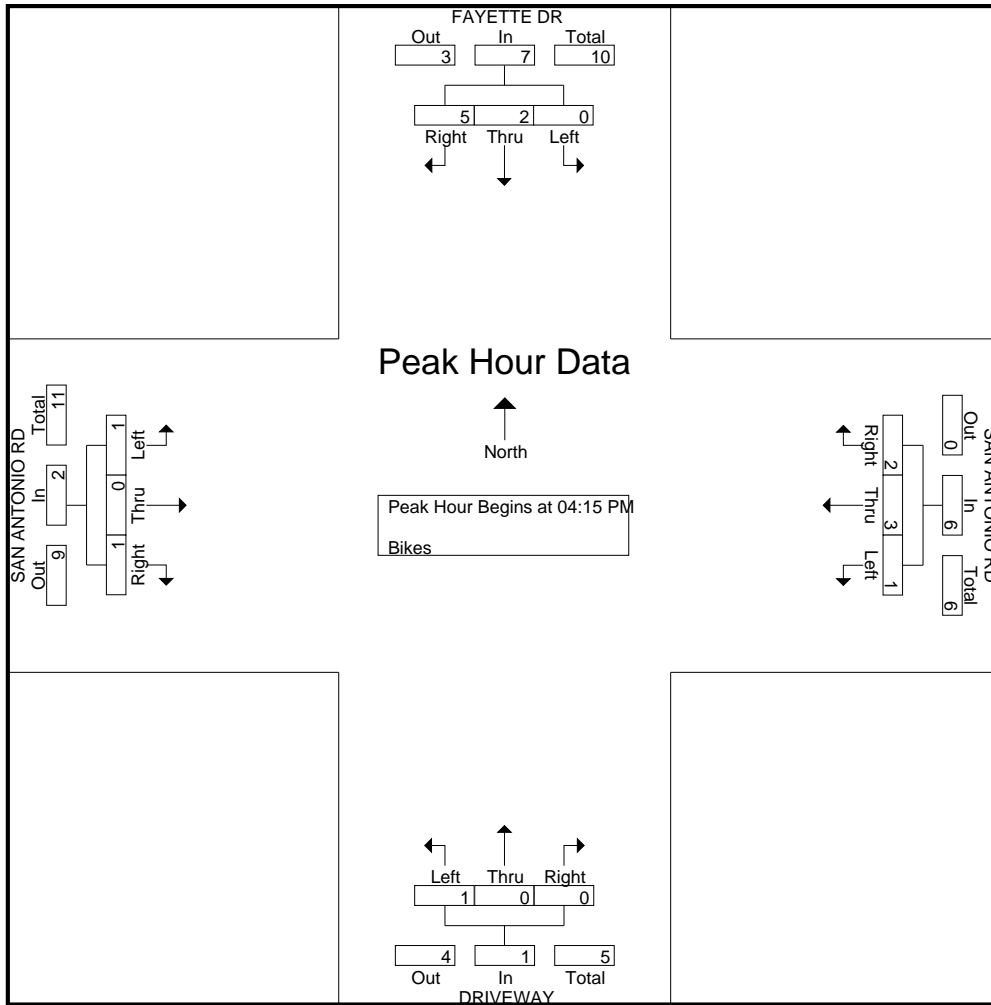

Traffic Data Service

San Jose, CA
 (408) 622-4787
 tdsbay@cs.com

File Name : 8AM FINAL
 Site Code : 00000008
 Start Date : 4/27/2021
 Page No : 1

Groups Printed- Lights - Buses - Trucks

Start Time	MILLER AVE Southbound					SAN ANTONIO RD Westbound					Northbound					SAN ANTONIO RD Eastbound					Int. Total
	Right	Thru	Left	Peds	App. Total	Right	Thru	Left	Peds	App. Total	Right	Thru	Left	Peds	App. Total	Right	Thru	Left	Peds	App. Total	
07:00 AM	2	0	0	1	3	3	82	0	2	87	0	0	0	0	0	0	46	0	0	46	136
07:15 AM	3	0	0	0	3	5	107	0	0	112	0	0	0	0	0	0	55	0	0	55	170
07:30 AM	6	0	0	3	9	7	107	0	2	116	0	0	0	0	0	0	76	0	0	76	201
07:45 AM	4	0	0	1	5	5	170	0	0	175	0	0	0	0	0	0	92	0	0	92	272
Total	15	0	0	5	20	20	466	0	4	490	0	0	0	0	0	0	269	0	0	269	779
08:00 AM	4	0	0	3	7	7	178	0	3	188	0	0	0	0	0	0	118	0	2	120	315
08:15 AM	4	0	0	3	7	8	152	0	3	163	0	0	0	0	0	0	150	0	0	150	320
08:30 AM	3	0	0	1	4	5	179	0	2	186	0	0	0	0	0	0	152	0	1	153	343
08:45 AM	3	0	0	1	4	2	144	0	1	147	0	0	0	0	0	0	114	0	0	114	265
Total	14	0	0	8	22	22	653	0	9	684	0	0	0	0	0	0	534	0	3	537	1243
Grand Total	29	0	0	13	42	42	1119	0	13	1174	0	0	0	0	0	0	803	0	3	806	2022
Apprch %	69	0	0	31		3.6	95.3	0	1.1		0	0	0	0		0	99.6	0	0.4		
Total %	1.4	0	0	0.6	2.1	2.1	55.3	0	0.6	58.1	0	0	0	0	0	0	39.7	0	0.1	39.9	
Lights	26	0	0	13	39	40	1059	0	13	1112	0	0	0	0	0	0	768	0	3	771	1922
% Lights	89.7	0	0	100	92.9	95.2	94.6	0	100	94.7	0	0	0	0	0	0	95.6	0	100	95.7	95.1
Buses	3	0	0	0	3	0	3	0	0	3	0	0	0	0	0	0	10	0	0	10	16
% Buses	10.3	0	0	0	7.1	0	0.3	0	0	0.3	0	0	0	0	0	0	1.2	0	0	1.2	0.8
Trucks	0	0	0	0	0	2	57	0	0	59	0	0	0	0	0	0	25	0	0	25	84
% Trucks	0	0	0	0	0	4.8	5.1	0	0	5	0	0	0	0	0	0	3.1	0	0	3.1	4.2

Start Time	MILLER AVE Southbound				SAN ANTONIO RD Westbound				Northbound				SAN ANTONIO RD Eastbound				Int. Total
	Right	Thru	Left	App. Total	Right	Thru	Left	App. Total	Right	Thru	Left	App. Total	Right	Thru	Left	App. Total	
Peak Hour Analysis From 07:00 AM to 08:45 AM - Peak 1 of 1																	
Peak Hour for Entire Intersection Begins at 07:45 AM																	
07:45 AM	4	0	0	4	5	170	0	175	0	0	0	0	0	92	0	92	271
08:00 AM	4	0	0	4	7	178	0	185	0	0	0	0	0	118	0	118	307
08:15 AM	4	0	0	4	8	152	0	160	0	0	0	0	0	150	0	150	314
08:30 AM	3	0	0	3	5	179	0	184	0	0	0	0	0	152	0	152	339
Total Volume	15	0	0	15	25	679	0	704	0	0	0	0	0	512	0	512	1231
% App. Total	100	0	0		3.6	96.4	0		0	0	0		0	100	0		
PHF	.938	.000	.000	.938	.781	.948	.000	.951	.000	.000	.000	.000	.000	.842	.000	.842	.908

Traffic Data Service

San Jose, CA
 (408) 622-4787
 tdsbay@cs.com

File Name : 8AM FINAL
 Site Code : 00000008
 Start Date : 4/27/2021
 Page No : 2

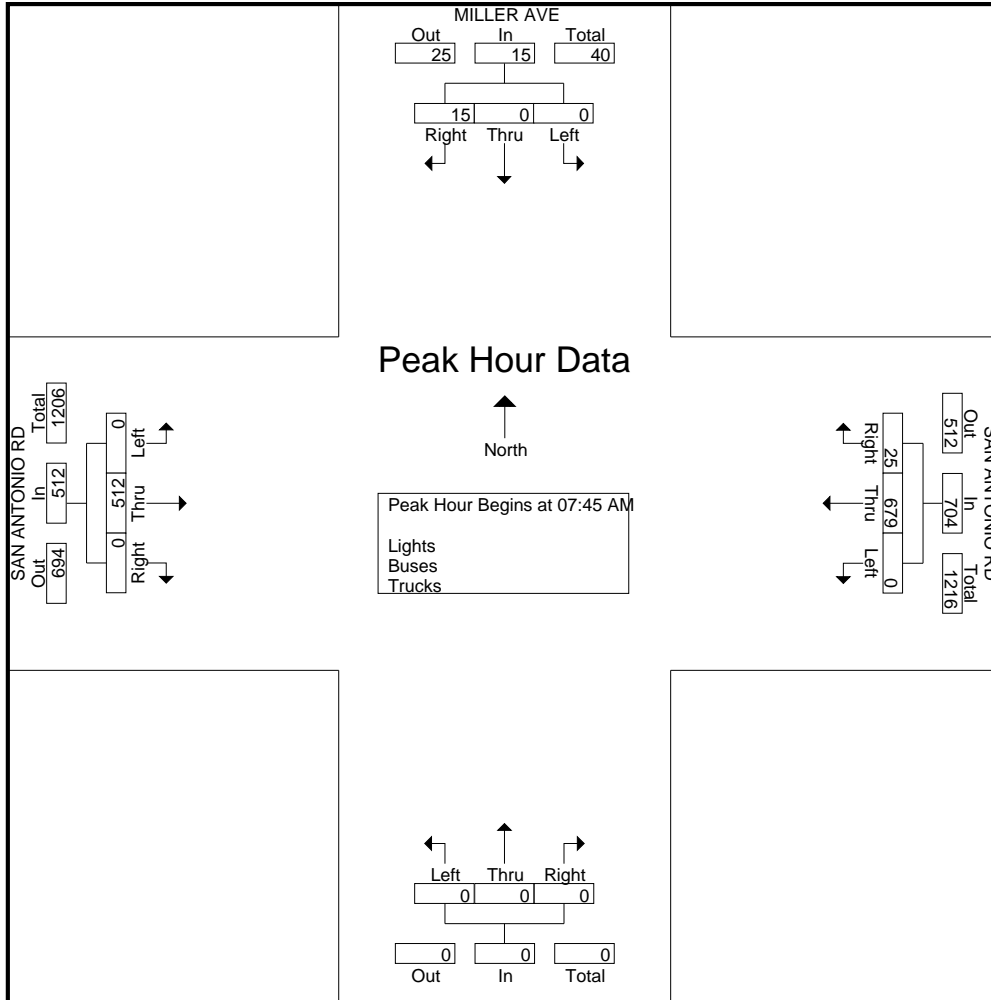

Traffic Data Service

San Jose, CA
 (408) 622-4787
 tdsbay@cs.com

File Name : 8AM FINAL
 Site Code : 00000008
 Start Date : 4/27/2021
 Page No : 1

Groups Printed- Bikes

Start Time	MILLER AVE Southbound					SAN ANTONIO RD Westbound					Northbound					SAN ANTONIO RD Eastbound					Int. Total
	Right	Thru	Left	Peds	App. Total	Right	Thru	Left	Peds	App. Total	Right	Thru	Left	Peds	App. Total	Right	Thru	Left	Peds	App. Total	
07:00 AM	0	0	0	0	0	0	0	0	0	0	0	0	0	0	0	0	0	0	0	0	0
07:15 AM	0	0	0	0	0	0	0	0	0	0	0	0	0	0	0	0	0	0	0	0	0
07:30 AM	0	0	0	0	0	0	0	0	0	0	0	0	0	0	0	0	0	0	0	0	0
07:45 AM	0	0	0	0	0	0	1	0	0	1	0	0	0	0	0	0	0	0	0	0	1
Total	0	0	0	0	0	0	1	0	0	1	0	0	0	0	0	0	0	0	0	0	1
08:00 AM	0	0	0	0	0	0	1	0	0	1	0	0	0	0	0	0	1	0	0	1	2
08:15 AM	0	0	0	0	0	0	0	0	0	0	0	0	0	0	0	0	0	0	0	0	0
08:30 AM	0	0	0	0	0	0	1	0	0	1	0	0	0	0	0	0	1	0	0	1	2
08:45 AM	0	0	0	0	0	0	0	0	0	0	0	0	0	0	0	0	0	0	0	0	0
Total	0	0	0	0	0	0	2	0	0	2	0	0	0	0	0	0	2	0	0	2	4
Grand Total	0	0	0	0	0	0	3	0	0	3	0	0	0	0	0	0	2	0	0	2	5
Apprch %	0	0	0	0	0	0	100	0	0	0	0	0	0	0	0	0	100	0	0	0	
Total %	0	0	0	0	0	0	60	0	0	60	0	0	0	0	0	0	40	0	0	40	

Start Time	MILLER AVE Southbound					SAN ANTONIO RD Westbound					Northbound					SAN ANTONIO RD Eastbound					Int. Total
	Right	Thru	Left	Peds	App. Total	Right	Thru	Left	Peds	App. Total	Right	Thru	Left	Peds	App. Total	Right	Thru	Left	Peds	App. Total	
07:45 AM	0	0	0	0	0	0	1	0	0	1	0	0	0	0	0	0	0	0	0	0	1
08:00 AM	0	0	0	0	0	0	1	0	0	1	0	0	0	0	0	0	1	0	0	1	2
08:15 AM	0	0	0	0	0	0	0	0	0	0	0	0	0	0	0	0	0	0	0	0	0
08:30 AM	0	0	0	0	0	0	1	0	0	1	0	0	0	0	0	0	1	0	0	1	2
Total Volume	0	0	0	0	0	0	3	0	0	3	0	0	0	0	0	0	2	0	0	2	5
% App. Total	0	0	0	0	0	0	100	0	0	0	0	0	0	0	0	0	100	0	0	0	
PHF	.000	.000	.000	.000	.000	.000	.750	.000	.000	.750	.000	.000	.000	.000	.000	.000	.500	.000	.000	.500	.625

Peak Hour Analysis From 07:00 AM to 08:45 AM - Peak 1 of 1
 Peak Hour for Entire Intersection Begins at 07:45 AM

Traffic Data Service

San Jose, CA
 (408) 622-4787
 tdsbay@cs.com

File Name : 8AM FINAL
 Site Code : 00000008
 Start Date : 4/27/2021
 Page No : 2

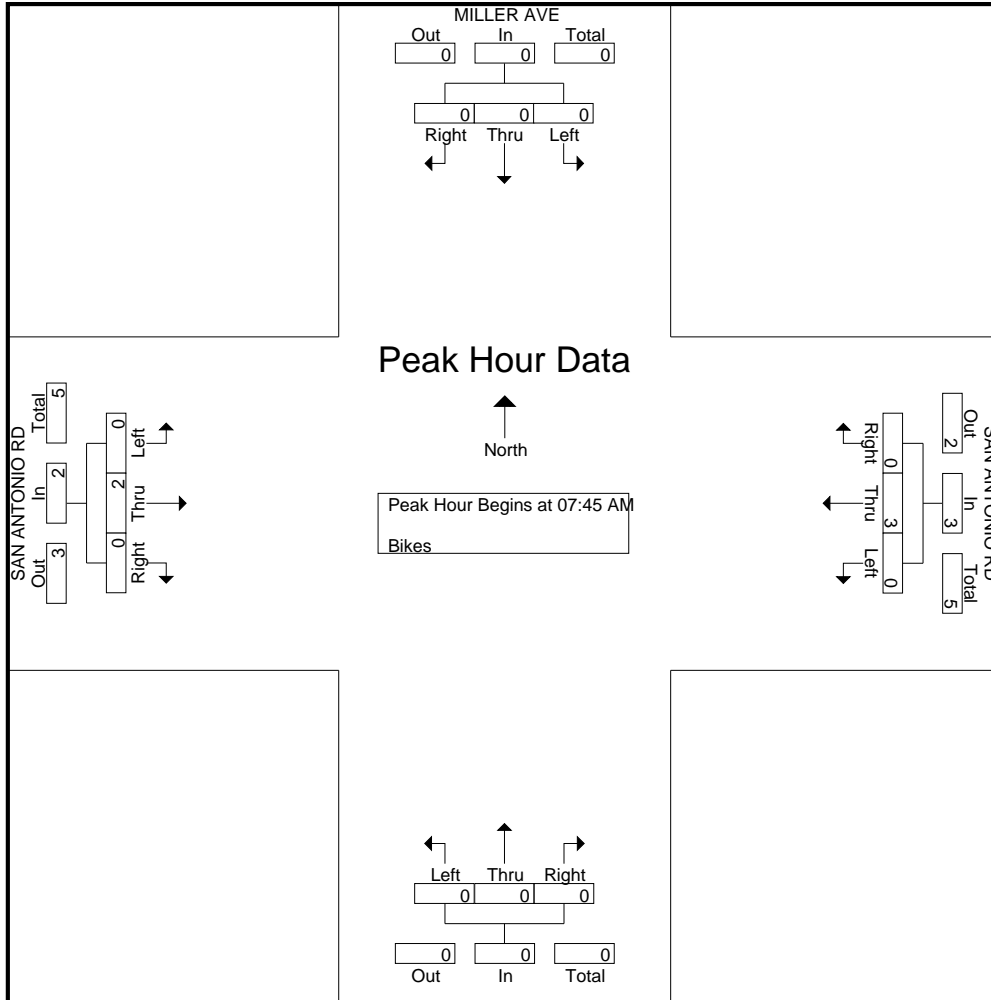

Traffic Data Service

San Jose, CA
 (408) 622-4787
 tdsbay@cs.com

File Name : 8PM FINAL
 Site Code : 00000008
 Start Date : 4/27/2021
 Page No : 1

Groups Printed- Lights - Buses - Trucks

Start Time	MILLER AVE Southbound					SAN ANTONIO RD Westbound					Northbound					SAN ANTONIO RD Eastbound					Int. Total
	Right	Thru	Left	Peds	App. Total	Right	Thru	Left	Peds	App. Total	Right	Thru	Left	Peds	App. Total	Right	Thru	Left	Peds	App. Total	
04:00 PM	5	0	0	1	6	9	198	0	6	213	0	0	0	0	0	0	185	0	1	186	405
04:15 PM	3	0	0	2	5	7	167	0	1	175	0	0	0	0	0	0	184	0	0	184	364
04:30 PM	2	0	0	3	5	8	199	0	2	209	0	0	0	0	0	0	178	0	0	178	392
04:45 PM	5	0	0	0	5	9	157	0	5	171	0	0	0	0	0	0	210	0	0	210	386
Total	15	0	0	6	21	33	721	0	14	768	0	0	0	0	0	0	757	0	1	758	1547
05:00 PM	6	0	0	3	9	9	191	0	7	207	0	0	0	0	0	0	182	0	0	182	398
05:15 PM	7	0	0	9	16	10	174	0	10	194	0	0	0	0	0	0	203	0	0	203	413
05:30 PM	3	0	0	1	4	15	169	0	3	187	0	0	0	0	0	0	213	0	0	213	404
05:45 PM	0	0	0	5	5	15	203	0	7	225	0	0	0	0	0	0	155	0	0	155	385
Total	16	0	0	18	34	49	737	0	27	813	0	0	0	0	0	0	753	0	0	753	1600
Grand Total	31	0	0	24	55	82	1458	0	41	1581	0	0	0	0	0	0	1510	0	1	1511	3147
Apprch %	56.4	0	0	43.6		5.2	92.2	0	2.6		0	0	0	0	0	0	99.9	0	0.1		
Total %	1	0	0	0.8	1.7	2.6	46.3	0	1.3	50.2	0	0	0	0	0	0	48	0	0	48	
Lights	31	0	0	24	55	81	1456	0	41	1578	0	0	0	0	0	0	1486	0	1	1487	3120
% Lights	100	0	0	100	100	98.8	99.9	0	100	99.8	0	0	0	0	0	0	98.4	0	100	98.4	99.1
Buses	0	0	0	0	0	0	0	0	0	0	0	0	0	0	0	0	9	0	0	9	9
% Buses	0	0	0	0	0	0	0	0	0	0	0	0	0	0	0	0	0.6	0	0	0.6	0.3
Trucks	0	0	0	0	0	1	2	0	0	3	0	0	0	0	0	0	15	0	0	15	18
% Trucks	0	0	0	0	0	1.2	0.1	0	0	0.2	0	0	0	0	0	0	1	0	0	1	0.6

Start Time	MILLER AVE Southbound				SAN ANTONIO RD Westbound				Northbound				SAN ANTONIO RD Eastbound				Int. Total	
	Right	Thru	Left	App. Total	Right	Thru	Left	App. Total	Right	Thru	Left	App. Total	Right	Thru	Left	App. Total		
Peak Hour Analysis From 04:00 PM to 05:45 PM - Peak 1 of 1																		
Peak Hour for Entire Intersection Begins at 04:45 PM																		
04:45 PM	5	0	0	5	9	157	0	166	0	0	0	0	0	0	210	0	210	381
05:00 PM	6	0	0	6	9	191	0	200	0	0	0	0	0	0	182	0	182	388
05:15 PM	7	0	0	7	10	174	0	184	0	0	0	0	0	0	203	0	203	394
05:30 PM	3	0	0	3	15	169	0	184	0	0	0	0	0	0	213	0	213	400
Total Volume	21	0	0	21	43	691	0	734	0	0	0	0	0	0	808	0	808	1563
% App. Total	100	0	0		5.9	94.1	0		0	0	0		0	0	100	0		
PHF	.750	.000	.000	.750	.717	.904	.000	.918	.000	.000	.000	.000	.000	.000	.948	.000	.948	.977

Traffic Data Service

San Jose, CA
 (408) 622-4787
 tdsbay@cs.com

File Name : 8PM FINAL
 Site Code : 00000008
 Start Date : 4/27/2021
 Page No : 2

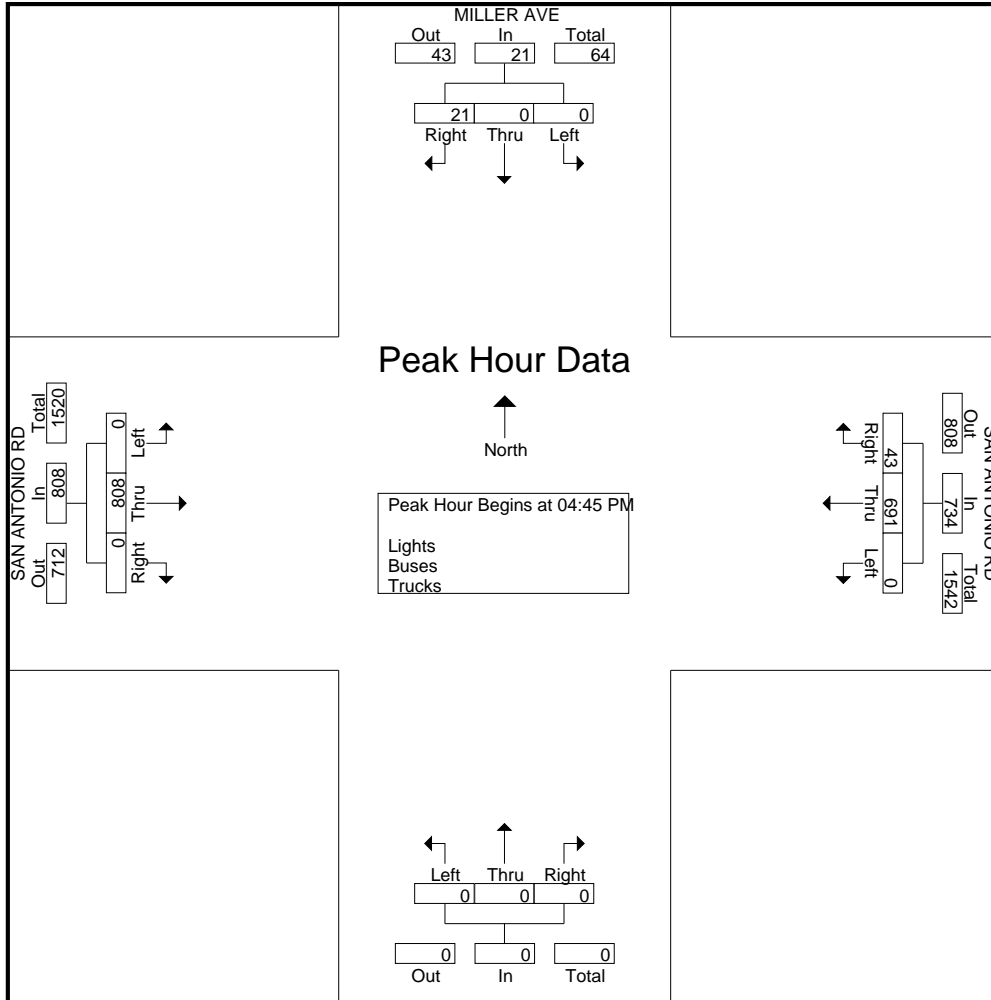

Traffic Data Service

San Jose, CA
 (408) 622-4787
 tdsbay@cs.com

File Name : 8PM FINAL
 Site Code : 00000008
 Start Date : 4/27/2021
 Page No : 1

Groups Printed- Bikes

Start Time	MILLER AVE Southbound					SAN ANTONIO RD Westbound					Northbound					SAN ANTONIO RD Eastbound					Int. Total
	Right	Thru	Left	Peds	App. Total	Right	Thru	Left	Peds	App. Total	Right	Thru	Left	Peds	App. Total	Right	Thru	Left	Peds	App. Total	
04:00 PM	0	0	0	0	0	0	1	0	0	1	0	0	0	0	0	0	1	0	0	1	2
04:15 PM	0	0	0	0	0	0	0	0	0	0	0	0	0	0	0	0	1	0	0	1	1
04:30 PM	0	0	0	0	0	0	0	0	0	0	0	0	0	0	0	0	1	0	0	1	1
04:45 PM	0	0	0	0	0	0	0	0	0	0	0	0	0	0	0	0	1	0	0	1	1
Total	0	0	0	0	0	0	1	0	0	1	0	0	0	0	0	0	4	0	0	4	5
05:00 PM	0	0	0	0	0	0	0	0	0	0	0	0	0	0	0	0	1	0	0	1	1
05:15 PM	0	0	0	0	0	1	0	0	0	1	0	0	0	0	0	0	0	0	0	0	1
05:30 PM	0	0	2	0	2	0	1	0	0	1	0	0	0	0	0	0	0	0	0	0	3
05:45 PM	0	0	0	0	0	0	1	0	0	1	0	0	0	0	0	0	0	0	0	0	1
Total	0	0	2	0	2	1	2	0	0	3	0	0	0	0	0	0	1	0	0	1	6
Grand Total	0	0	2	0	2	1	3	0	0	4	0	0	0	0	0	0	5	0	0	5	11
Apprch %	0	0	100	0		25	75	0	0		0	0	0	0		0	100	0	0		
Total %	0	0	18.2	0	18.2	9.1	27.3	0	0	36.4	0	0	0	0	0	0	45.5	0	0	45.5	

Start Time	MILLER AVE Southbound					SAN ANTONIO RD Westbound					Northbound					SAN ANTONIO RD Eastbound					Int. Total
	Right	Thru	Left	Peds	App. Total	Right	Thru	Left	Peds	App. Total	Right	Thru	Left	Peds	App. Total	Right	Thru	Left	Peds	App. Total	
04:45 PM	0	0	0	0	0	0	0	0	0	0	0	0	0	0	0	0	1	0	0	1	1
05:00 PM	0	0	0	0	0	0	0	0	0	0	0	0	0	0	0	0	1	0	0	1	1
05:15 PM	0	0	0	0	0	1	0	0	0	1	0	0	0	0	0	0	0	0	0	0	1
05:30 PM	0	0	2	0	2	0	1	0	0	1	0	0	0	0	0	0	0	0	0	0	3
Total Volume	0	0	2	0	2	1	1	0	0	2	0	0	0	0	0	0	2	0	0	2	6
% App. Total	0	0	100	0		50	50	0	0		0	0	0	0		0	100	0	0		
PHF	.000	.000	.250	0	.250	.250	.250	.000	0	.500	.000	.000	.000	0	.000	.000	.500	.000	0	.500	.500

Peak Hour Analysis From 04:00 PM to 05:45 PM - Peak 1 of 1
 Peak Hour for Entire Intersection Begins at 04:45 PM

Traffic Data Service

San Jose, CA
(408) 622-4787
tdsbay@cs.com

File Name : 8PM FINAL
Site Code : 00000008
Start Date : 4/27/2021
Page No : 2

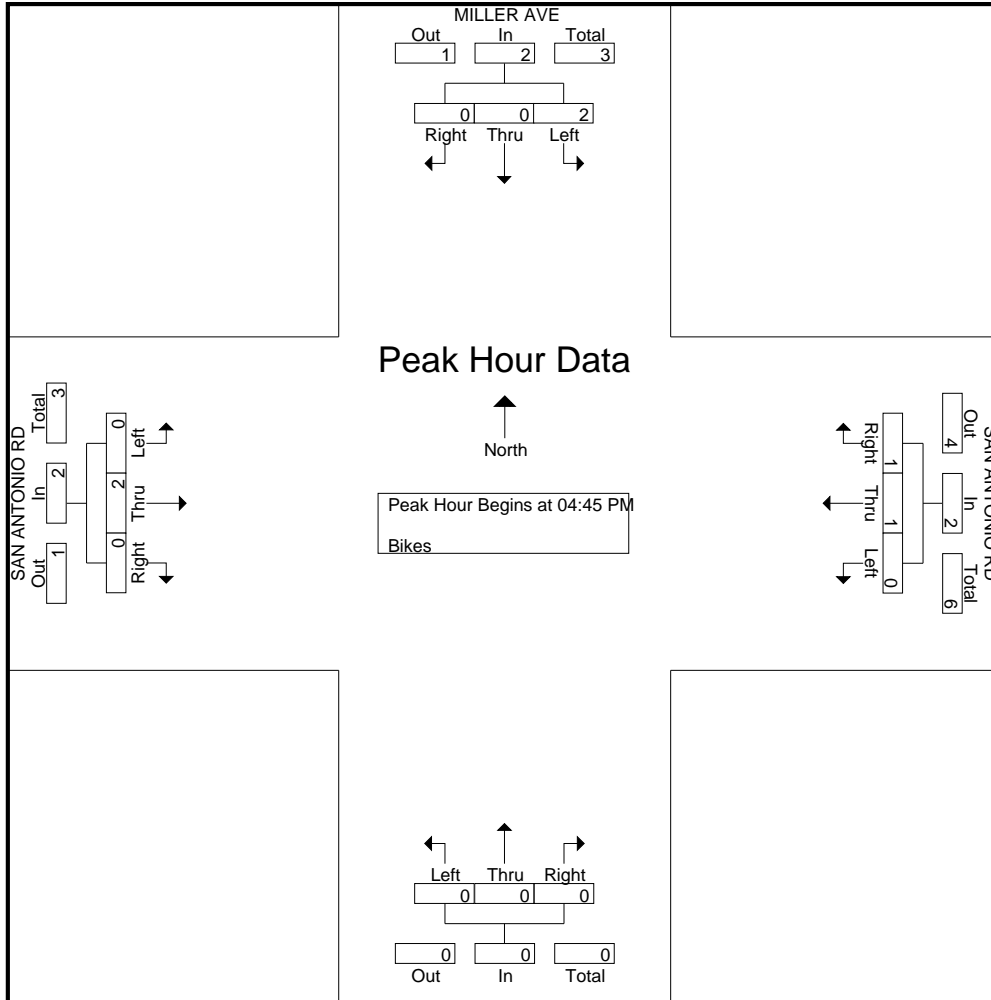

Traffic Data Service

San Jose, CA
(408) 622-4787
tdsbay@cs.com

File Name : 9AM FINAL
Site Code : 00000009
Start Date : 4/27/2021
Page No : 1

Groups Printed- Lights - Buses - Trucks

Start Time	Southbound					SAN ANTONIO RD Westbound					NITA AVE Northbound					SAN ANTONIO RD Eastbound					Int. Total
	Right	Thru	Left	Peds	App. Total	Right	Thru	Left	Peds	App. Total	Right	Thru	Left	Peds	App. Total	Right	Thru	Left	Peds	App. Total	
07:00 AM	0	0	0	0	0	0	138	9	0	147	2	0	0	2	4	2	95	0	4	101	252
07:15 AM	0	0	0	0	0	0	165	11	0	176	4	0	0	0	4	2	98	0	0	100	280
07:30 AM	0	0	0	0	0	0	171	16	0	187	6	0	0	0	6	3	139	0	0	142	335
07:45 AM	0	0	0	0	0	0	203	13	0	216	12	0	0	2	14	1	153	0	5	159	389
Total	0	0	0	0	0	0	677	49	0	726	24	0	0	4	28	8	485	0	9	502	1256
08:00 AM	0	0	0	0	0	0	192	29	0	221	7	0	0	0	7	5	167	0	8	180	408
08:15 AM	0	0	0	0	0	0	212	35	0	247	12	0	0	0	12	0	188	0	2	190	449
08:30 AM	0	0	0	0	0	0	212	42	0	254	15	0	0	2	17	7	226	0	6	239	510
08:45 AM	0	0	0	0	0	0	231	19	0	250	4	0	0	6	10	7	187	0	8	202	462
Total	0	0	0	0	0	0	847	125	0	972	38	0	0	8	46	19	768	0	24	811	1829
Grand Total	0	0	0	0	0	0	1524	174	0	1698	62	0	0	12	74	27	1253	0	33	1313	3085
Apprch %	0	0	0	0	0	0	89.8	10.2	0	90.0	83.8	0	0	16.2	83.8	2.1	95.4	0	2.5	95.4	
Total %	0	0	0	0	0	0	49.4	5.6	0	55.0	2	0	0	0.4	2.4	0.9	40.6	0	1.1	42.6	
Lights	0	0	0	0	0	0	1433	170	0	1603	58	0	0	12	70	27	1215	0	33	1275	2948
% Lights	0	0	0	0	0	0	94	97.7	0	94.4	93.5	0	0	100	94.6	100	97	0	100	97.1	95.6
Buses	0	0	0	0	0	0	7	0	0	7	0	0	0	0	0	0	4	0	0	4	11
% Buses	0	0	0	0	0	0	0.5	0	0	0.4	0	0	0	0	0	0	0.3	0	0	0.3	0.4
Trucks	0	0	0	0	0	0	84	4	0	88	4	0	0	0	4	0	34	0	0	34	126
% Trucks	0	0	0	0	0	0	5.5	2.3	0	5.2	6.5	0	0	0	5.4	0	2.7	0	0	2.6	4.1

Start Time	Southbound				SAN ANTONIO RD Westbound				NITA AVE Northbound				SAN ANTONIO RD Eastbound				Int. Total
	Right	Thru	Left	App. Total	Right	Thru	Left	App. Total	Right	Thru	Left	App. Total	Right	Thru	Left	App. Total	
Peak Hour Analysis From 07:00 AM to 08:45 AM - Peak 1 of 1																	
Peak Hour for Entire Intersection Begins at 08:00 AM																	
08:00 AM	0	0	0	0	0	192	29	221	7	0	0	7	5	167	0	172	400
08:15 AM	0	0	0	0	0	212	35	247	12	0	0	12	0	188	0	188	447
08:30 AM	0	0	0	0	0	212	42	254	15	0	0	15	7	226	0	233	502
08:45 AM	0	0	0	0	0	231	19	250	4	0	0	4	7	187	0	194	448
Total Volume	0	0	0	0	0	847	125	972	38	0	0	38	19	768	0	787	1797
% App. Total	0	0	0	0	0	87.1	12.9		100	0	0		2.4	97.6	0		
PHF	.000	.000	.000	.000	.000	.917	.744	.957	.633	.000	.000	.633	.679	.850	.000	.844	.895

Traffic Data Service

San Jose, CA
 (408) 622-4787
 tdsbay@cs.com

File Name : 9AM FINAL
 Site Code : 00000009
 Start Date : 4/27/2021
 Page No : 2

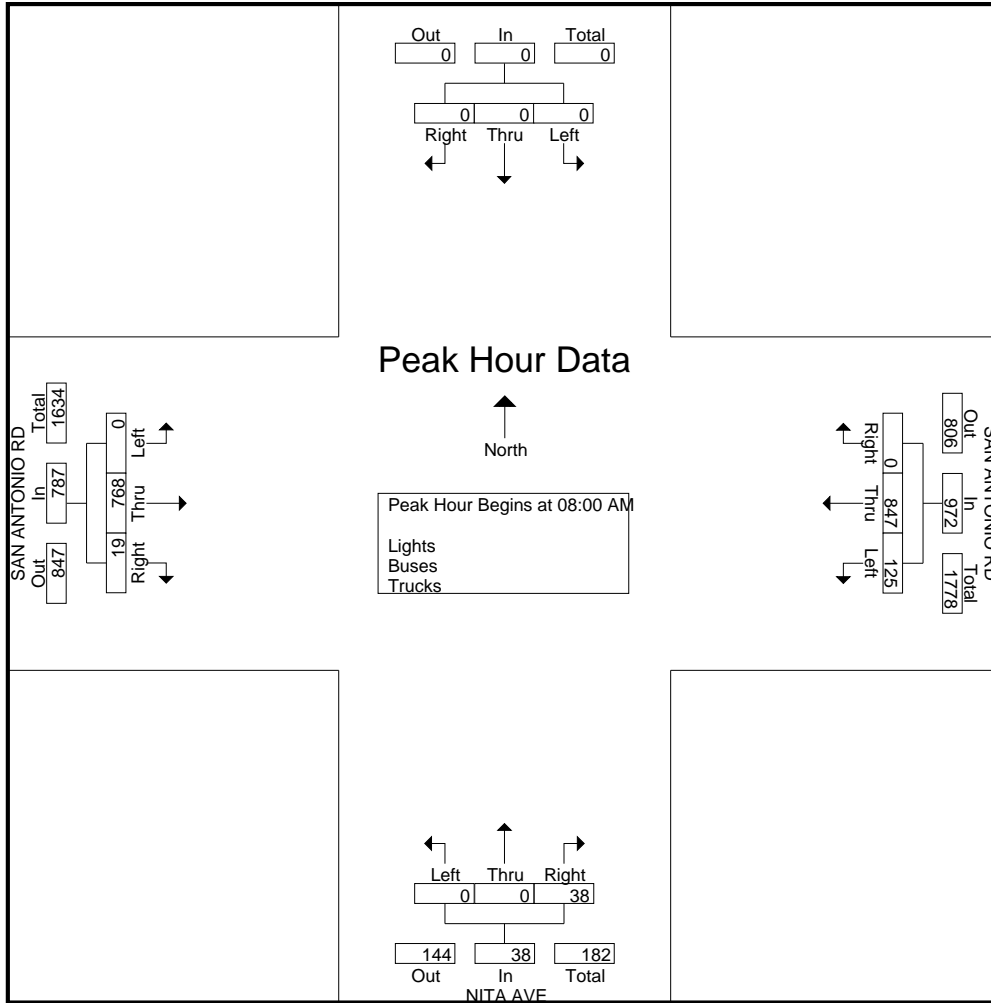

Traffic Data Service

San Jose, CA
 (408) 622-4787
 tdsbay@cs.com

File Name : 9AM FINAL
 Site Code : 00000009
 Start Date : 4/27/2021
 Page No : 1

Groups Printed- Bikes

Start Time	Southbound					SAN ANTONIO RD Westbound					NITA AVE Northbound					SAN ANTONIO RD Eastbound					Int. Total
	Right	Thru	Left	Peds	App. Total	Right	Thru	Left	Peds	App. Total	Right	Thru	Left	Peds	App. Total	Right	Thru	Left	Peds	App. Total	
07:00 AM	0	0	0	0	0	0	0	0	0	0	0	0	0	0	0	0	0	0	0	0	0
07:15 AM	0	0	0	0	0	0	0	0	0	0	0	0	0	0	0	0	0	0	0	0	0
07:30 AM	0	0	0	0	0	0	0	0	0	0	0	0	0	0	0	0	0	0	0	0	0
07:45 AM	0	0	0	0	0	0	0	0	0	0	0	0	0	0	0	0	0	0	0	0	0
Total	0	0	0	0	0	0	0	0	0	0	0	0	0	0	0	0	0	0	0	0	0
08:00 AM	0	0	0	0	0	0	1	0	0	1	0	0	0	0	0	0	0	0	0	0	1
08:15 AM	0	0	0	0	0	0	0	0	0	0	0	0	0	0	0	0	0	0	0	0	0
08:30 AM	0	0	0	0	0	0	0	0	0	0	0	0	0	0	0	0	0	0	0	0	0
08:45 AM	0	0	0	0	0	0	0	0	0	0	0	0	0	0	0	0	0	0	0	0	0
Total	0	0	0	0	0	0	1	0	0	1	0	0	0	0	0	0	0	0	0	0	1
Grand Total	0	0	0	0	0	0	1	0	0	1	0	0	0	0	0	0	0	0	0	0	1
Apprch %	0	0	0	0	0	0	100	0	0	100	0	0	0	0	0	0	0	0	0	0	0
Total %	0	0	0	0	0	0	100	0	0	100	0	0	0	0	0	0	0	0	0	0	0

Start Time	Southbound					SAN ANTONIO RD Westbound					NITA AVE Northbound					SAN ANTONIO RD Eastbound					Int. Total
	Right	Thru	Left	Peds	App. Total	Right	Thru	Left	Peds	App. Total	Right	Thru	Left	Peds	App. Total	Right	Thru	Left	Peds	App. Total	
07:15 AM	0	0	0	0	0	0	0	0	0	0	0	0	0	0	0	0	0	0	0	0	0
07:30 AM	0	0	0	0	0	0	0	0	0	0	0	0	0	0	0	0	0	0	0	0	0
07:45 AM	0	0	0	0	0	0	0	0	0	0	0	0	0	0	0	0	0	0	0	0	0
08:00 AM	0	0	0	0	0	0	1	0	0	1	0	0	0	0	0	0	0	0	0	0	1
Total Volume	0	0	0	0	0	0	1	0	0	1	0	0	0	0	0	0	0	0	0	0	1
% App. Total	0	0	0	0	0	0	100	0	0	100	0	0	0	0	0	0	0	0	0	0	0
PHF	.000	.000	.000	.000	.000	.000	.250	.000	.000	.250	.000	.000	.000	.000	.000	.000	.000	.000	.000	.000	.250

Peak Hour Analysis From 07:00 AM to 08:45 AM - Peak 1 of 1
 Peak Hour for Entire Intersection Begins at 07:15 AM

Traffic Data Service

San Jose, CA
(408) 622-4787
tdsbay@cs.com

File Name : 9AM FINAL
Site Code : 00000009
Start Date : 4/27/2021
Page No : 2

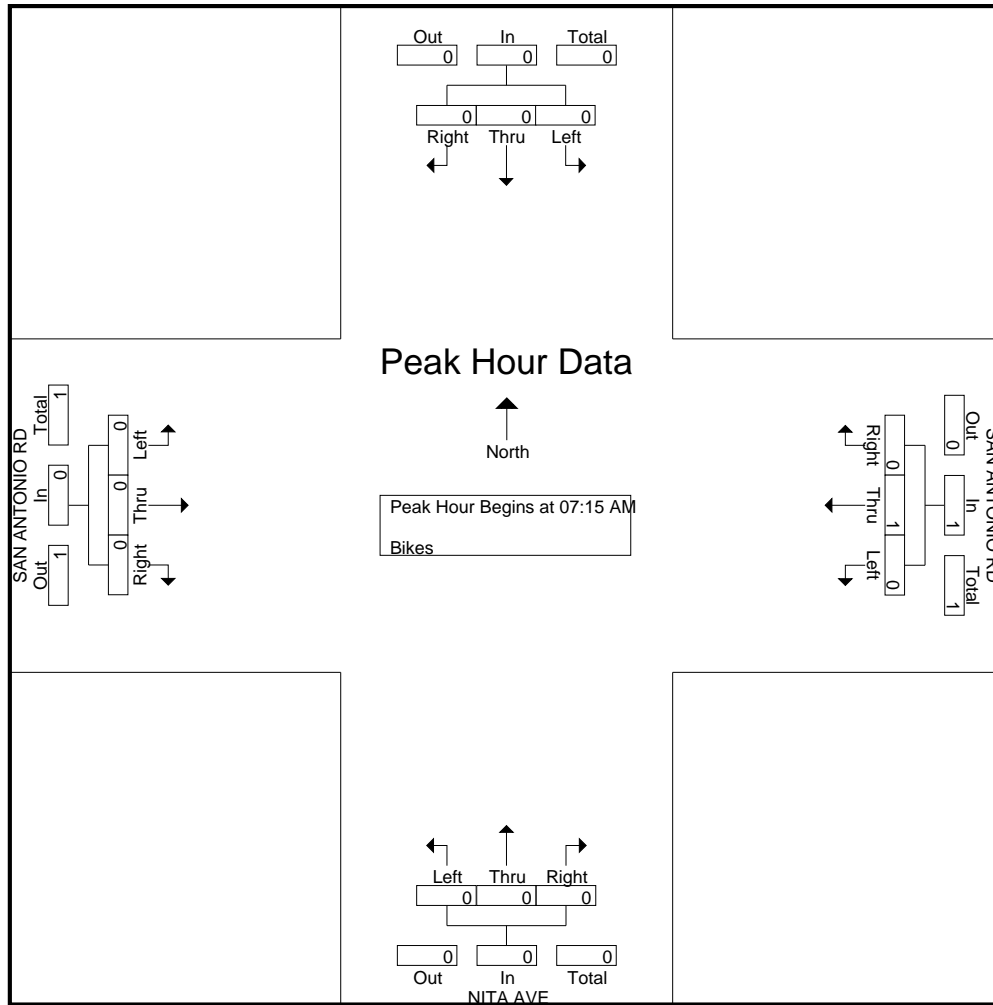

Traffic Data Service

San Jose, CA
 (408) 622-4787
 tdsbay@cs.com

File Name : 9PM FINAL
 Site Code : 00000009
 Start Date : 4/27/2021
 Page No : 1

Groups Printed- Lights - Buses - Trucks

Start Time	Southbound					SAN ANTONIO RD Westbound					NITA AVE Northbound					SAN ANTONIO RD Eastbound					Int. Total
	Right	Thru	Left	Peds	App. Total	Right	Thru	Left	Peds	App. Total	Right	Thru	Left	Peds	App. Total	Right	Thru	Left	Peds	App. Total	
04:00 PM	0	0	0	0	0	0	212	6	0	218	6	0	0	2	8	8	248	0	3	259	485
04:15 PM	0	0	0	0	0	0	275	12	0	287	6	0	0	3	9	6	177	1	7	191	487
04:30 PM	0	0	0	0	0	0	260	13	0	273	7	0	0	0	7	12	252	0	5	269	549
04:45 PM	0	0	0	0	0	0	239	14	0	253	4	0	0	4	8	20	196	0	5	221	482
Total	0	0	0	0	0	0	986	45	0	1031	23	0	0	9	32	46	873	1	20	940	2003
05:00 PM	0	0	0	0	0	0	265	22	0	287	15	0	0	2	17	16	238	0	3	257	561
05:15 PM	0	0	0	0	0	0	262	7	0	269	5	0	0	3	8	9	252	0	5	266	543
05:30 PM	0	0	0	0	0	0	261	11	0	272	7	0	0	3	10	9	258	0	6	273	555
05:45 PM	0	0	0	0	0	0	274	13	0	287	6	0	0	2	8	3	237	0	4	244	539
Total	0	0	0	0	0	0	1062	53	0	1115	33	0	0	10	43	37	985	0	18	1040	2198
Grand Total	0	0	0	0	0	0	2048	98	0	2146	56	0	0	19	75	83	1858	1	38	1980	4201
Apprch %	0	0	0	0	0	0	95.4	4.6	0	2146	74.7	0	0	25.3	75	4.2	93.8	0.1	1.9	1980	4201
Total %	0	0	0	0	0	0	48.8	2.3	0	51.1	1.3	0	0	0.5	1.8	2	44.2	0	0.9	47.1	
Lights	0	0	0	0	0	0	2034	98	0	2132	56	0	0	19	75	82	1831	1	38	1952	4159
% Lights	0	0	0	0	0	0	99.3	100	0	99.3	100	0	0	100	100	98.8	98.5	100	100	98.6	99
Buses	0	0	0	0	0	0	6	0	0	6	0	0	0	0	0	0	7	0	0	7	13
% Buses	0	0	0	0	0	0	0.3	0	0	0.3	0	0	0	0	0	0	0.4	0	0	0.4	0.3
Trucks	0	0	0	0	0	0	8	0	0	8	0	0	0	0	0	1	20	0	0	21	29
% Trucks	0	0	0	0	0	0	0.4	0	0	0.4	0	0	0	0	0	1.2	1.1	0	0	1.1	0.7

Start Time	Southbound				SAN ANTONIO RD Westbound				NITA AVE Northbound				SAN ANTONIO RD Eastbound				Int. Total
	Right	Thru	Left	App. Total	Right	Thru	Left	App. Total	Right	Thru	Left	App. Total	Right	Thru	Left	App. Total	
Peak Hour Analysis From 04:00 PM to 05:45 PM - Peak 1 of 1																	
Peak Hour for Entire Intersection Begins at 05:00 PM																	
05:00 PM	0	0	0	0	0	265	22	287	15	0	0	15	16	238	0	254	556
05:15 PM	0	0	0	0	0	262	7	269	5	0	0	5	9	252	0	261	535
05:30 PM	0	0	0	0	0	261	11	272	7	0	0	7	9	258	0	267	546
05:45 PM	0	0	0	0	0	274	13	287	6	0	0	6	3	237	0	240	533
Total Volume	0	0	0	0	0	1062	53	1115	33	0	0	33	37	985	0	1022	2170
% App. Total	0	0	0	0	0	95.2	4.8	1115	100	0	0	1115	3.6	96.4	0	1115	2170
PHF	.000	.000	.000	.000	.000	.969	.602	.971	.550	.000	.000	.550	.578	.954	.000	.957	.976

Traffic Data Service

San Jose, CA
 (408) 622-4787
 tdsbay@cs.com

File Name : 9PM FINAL
 Site Code : 00000009
 Start Date : 4/27/2021
 Page No : 2

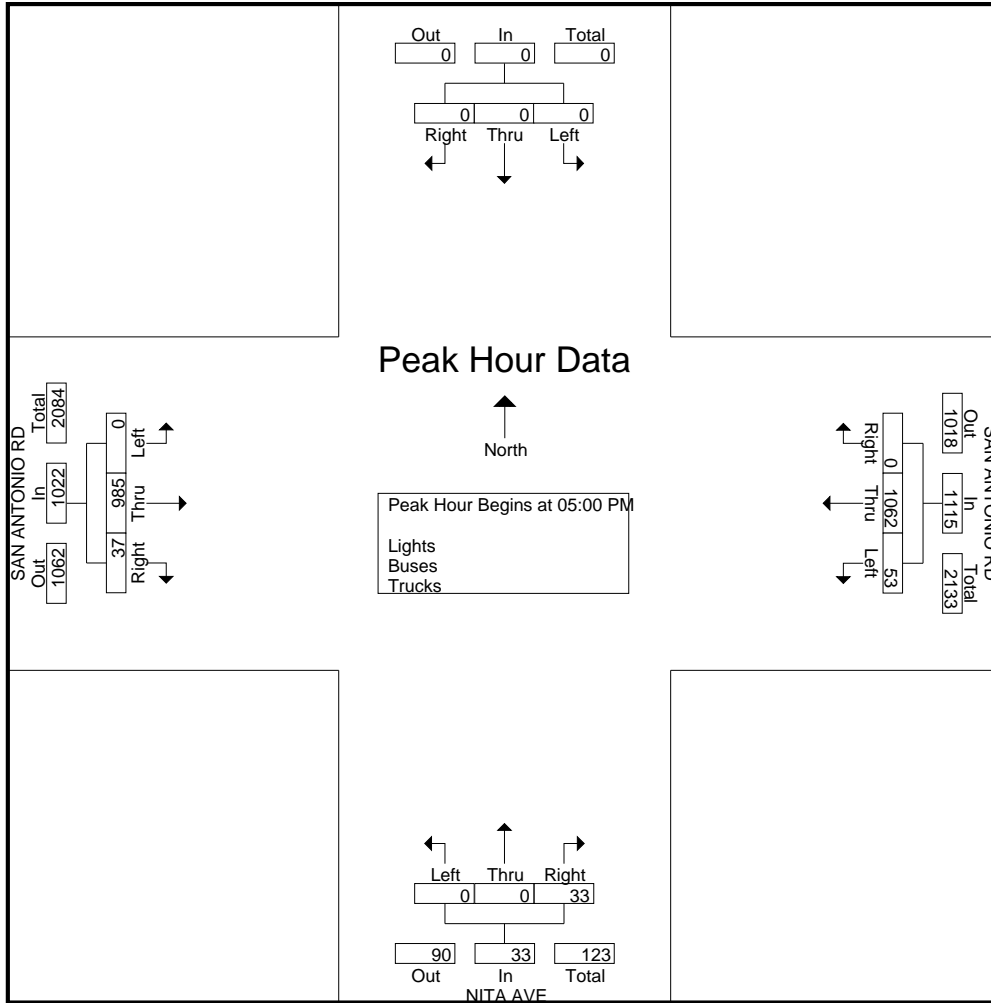

Traffic Data Service

San Jose, CA
 (408) 622-4787
 tdsbay@cs.com

File Name : 9PM FINAL
 Site Code : 00000009
 Start Date : 4/27/2021
 Page No : 1

Groups Printed- Bikes

Start Time	Southbound					SAN ANTONIO RD Westbound					NITA AVE Northbound					SAN ANTONIO RD Eastbound					Int. Total
	Right	Thru	Left	Peds	App. Total	Right	Thru	Left	Peds	App. Total	Right	Thru	Left	Peds	App. Total	Right	Thru	Left	Peds	App. Total	
04:00 PM	0	0	0	0	0	0	0	0	0	0	0	0	0	0	0	0	0	0	0	0	0
04:15 PM	0	0	0	0	0	0	0	0	0	0	1	0	0	0	1	0	0	0	0	0	1
04:30 PM	0	0	0	0	0	0	0	0	0	0	0	0	0	0	0	1	0	0	0	1	1
04:45 PM	0	0	0	0	0	0	0	0	0	0	0	0	0	0	0	0	0	0	0	0	0
Total	0	0	0	0	0	0	0	0	0	0	1	0	0	0	1	1	0	0	0	1	2
05:00 PM	0	0	0	0	0	0	0	0	0	0	0	0	0	0	0	0	1	0	0	1	1
05:15 PM	0	0	0	0	0	0	0	0	0	0	0	0	0	0	0	0	0	0	0	0	0
05:30 PM	0	0	0	0	0	0	0	0	0	0	0	0	0	0	0	0	0	0	0	0	0
05:45 PM	0	0	0	0	0	0	0	0	0	0	0	0	0	0	0	0	0	0	0	0	0
Total	0	0	0	0	0	0	0	0	0	0	0	0	0	0	0	0	1	0	0	1	1
Grand Total	0	0	0	0	0	0	0	0	0	0	1	0	0	0	1	1	1	0	0	2	3
Apprch %	0	0	0	0	0	0	0	0	0	0	100	0	0	0	0	50	50	0	0	0	
Total %	0	0	0	0	0	0	0	0	0	0	33.3	0	0	0	33.3	33.3	33.3	0	0	66.7	

Start Time	Southbound					SAN ANTONIO RD Westbound					NITA AVE Northbound					SAN ANTONIO RD Eastbound					Int. Total
	Right	Thru	Left	Peds	App. Total	Right	Thru	Left	Peds	App. Total	Right	Thru	Left	Peds	App. Total	Right	Thru	Left	Peds	App. Total	
04:15 PM	0	0	0	0	0	0	0	0	0	0	1	0	0	0	1	0	0	0	0	0	1
04:30 PM	0	0	0	0	0	0	0	0	0	0	0	0	0	0	0	1	0	0	0	1	1
04:45 PM	0	0	0	0	0	0	0	0	0	0	0	0	0	0	0	0	0	0	0	0	0
05:00 PM	0	0	0	0	0	0	0	0	0	0	0	0	0	0	0	0	1	0	0	1	1
Total Volume	0	0	0	0	0	0	0	0	0	0	1	0	0	0	1	1	1	0	0	2	3
% App. Total	0	0	0	0	0	0	0	0	0	0	100	0	0	0	0	50	50	0	0	0	
PHF	.000	.000	.000	.000	.000	.000	.000	.000	.000	.000	.250	.000	.000	.250	.250	.250	.250	.000	.500	.750	

Peak Hour Analysis From 04:00 PM to 05:45 PM - Peak 1 of 1
 Peak Hour for Entire Intersection Begins at 04:15 PM

Traffic Data Service

San Jose, CA
 (408) 622-4787
 tdsbay@cs.com

File Name : 9PM FINAL
 Site Code : 00000009
 Start Date : 4/27/2021
 Page No : 2

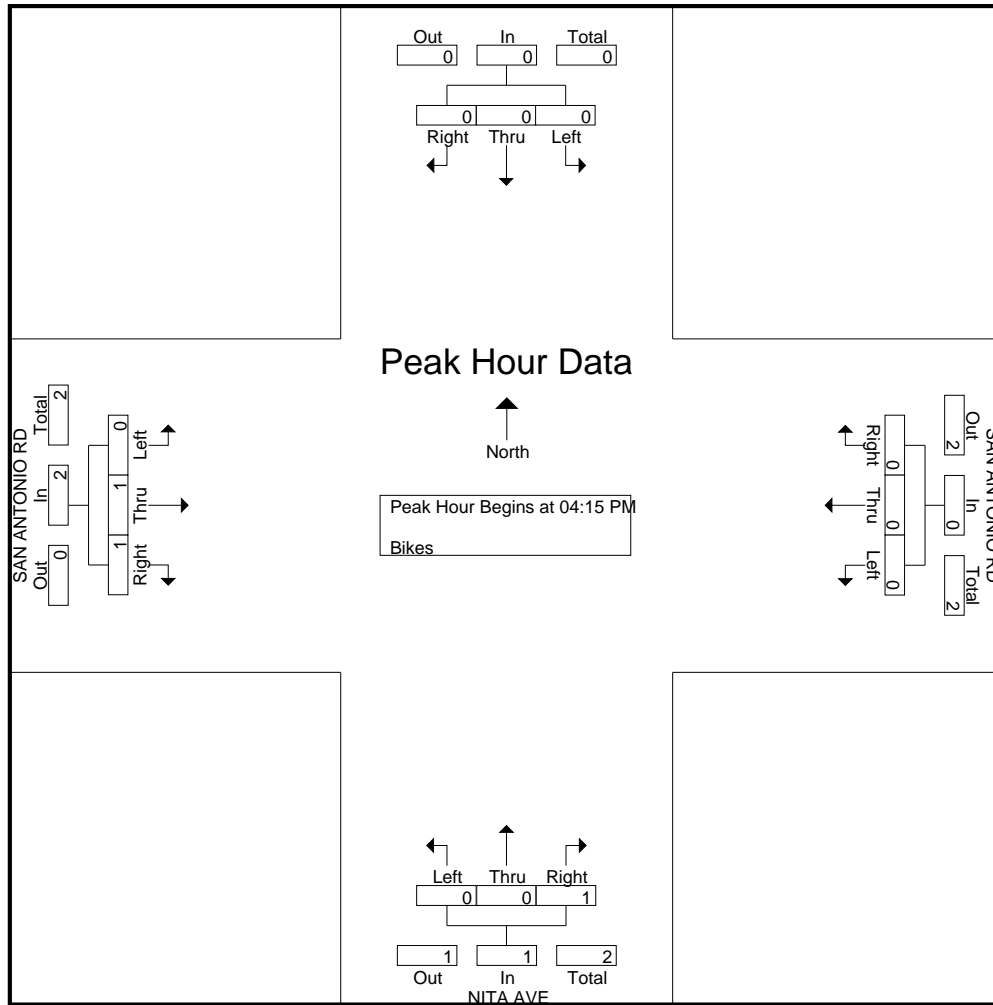

Traffic Data Service

San Jose, CA
 (408) 622-4787
 tdsbay@cs.com

File Name : 10AM FINAL
 Site Code : 00000010
 Start Date : 4/27/2021
 Page No : 1

Groups Printed- Lights - Buses - Trucks

Start Time	CALIFORNIA ST Southbound					SAN ANTONIO RD Westbound					CALIFORNIA ST Northbound					SAN ANTONIO RD Eastbound					Int. Total
	Right	Thru	Left	Peds	App. Total	Right	Thru	Left	Peds	App. Total	Right	Thru	Left	Peds	App. Total	Right	Thru	Left	Peds	App. Total	
07:00 AM	5	7	23	0	35	10	77	36	1	124	39	5	5	0	49	4	48	4	1	57	265
07:15 AM	1	10	30	0	41	16	103	38	1	158	49	6	10	3	68	3	46	7	2	58	325
07:30 AM	14	4	29	0	47	20	110	59	0	189	55	6	7	3	71	3	77	4	2	86	393
07:45 AM	9	10	38	3	60	19	178	34	0	231	48	9	11	1	69	4	108	8	1	121	481
Total	29	31	120	3	183	65	468	167	2	702	191	26	33	7	257	14	279	23	6	322	1464
08:00 AM	5	11	35	0	51	21	141	38	1	201	43	6	20	0	69	7	124	3	0	134	455
08:15 AM	5	10	34	2	51	17	168	45	0	230	44	7	15	1	67	11	110	8	0	129	477
08:30 AM	2	9	48	0	59	19	139	55	0	213	61	11	7	1	80	13	136	12	1	162	514
08:45 AM	2	7	40	0	49	22	172	47	0	241	57	9	13	1	80	6	120	4	2	132	502
Total	14	37	157	2	210	79	620	185	1	885	205	33	55	3	296	37	490	27	3	557	1948
Grand Total	43	68	277	5	393	144	1088	352	3	1587	396	59	88	10	553	51	769	50	9	879	3412
Apprch %	10.9	17.3	70.5	1.3		9.1	68.6	22.2	0.2		71.6	10.7	15.9	1.8		5.8	87.5	5.7	1		
Total %	1.3	2	8.1	0.1	11.5	4.2	31.9	10.3	0.1	46.5	11.6	1.7	2.6	0.3	16.2	1.5	22.5	1.5	0.3	25.8	
Lights	40	66	273	5	384	137	1030	328	3	1498	387	56	80	10	533	45	741	47	9	842	3257
% Lights	93	97.1	98.6	100	97.7	95.1	94.7	93.2	100	94.4	97.7	94.9	90.9	100	96.4	88.2	96.4	94	100	95.8	95.5
Buses	0	0	0	0	0	0	2	1	0	3	0	2	0	0	2	4	5	1	0	10	15
% Buses	0	0	0	0	0	0	0.2	0.3	0	0.2	0	3.4	0	0	0.4	7.8	0.7	2	0	1.1	0.4
Trucks	3	2	4	0	9	7	56	23	0	86	9	1	8	0	18	2	23	2	0	27	140
% Trucks	7	2.9	1.4	0	2.3	4.9	5.1	6.5	0	5.4	2.3	1.7	9.1	0	3.3	3.9	3	4	0	3.1	4.1

Start Time	CALIFORNIA ST Southbound				SAN ANTONIO RD Westbound				CALIFORNIA ST Northbound				SAN ANTONIO RD Eastbound				Int. Total
	Right	Thru	Left	App. Total	Right	Thru	Left	App. Total	Right	Thru	Left	App. Total	Right	Thru	Left	App. Total	
Peak Hour Analysis From 07:00 AM to 08:45 AM - Peak 1 of 1																	
Peak Hour for Entire Intersection Begins at 08:00 AM																	
08:00 AM	5	11	35	51	21	141	38	200	43	6	20	69	7	124	3	134	454
08:15 AM	5	10	34	49	17	168	45	230	44	7	15	66	11	110	8	129	474
08:30 AM	2	9	48	59	19	139	55	213	61	11	7	79	13	136	12	161	512
08:45 AM	2	7	40	49	22	172	47	241	57	9	13	79	6	120	4	130	499
Total Volume	14	37	157	208	79	620	185	884	205	33	55	293	37	490	27	554	1939
% App. Total	6.7	17.8	75.5		8.9	70.1	20.9		70	11.3	18.8		6.7	88.4	4.9		
PHF	.700	.841	.818	.881	.898	.901	.841	.917	.840	.750	.688	.927	.712	.901	.563	.860	.947

Traffic Data Service

San Jose, CA
 (408) 622-4787
 tdsbay@cs.com

File Name : 10AM FINAL
 Site Code : 00000010
 Start Date : 4/27/2021
 Page No : 2

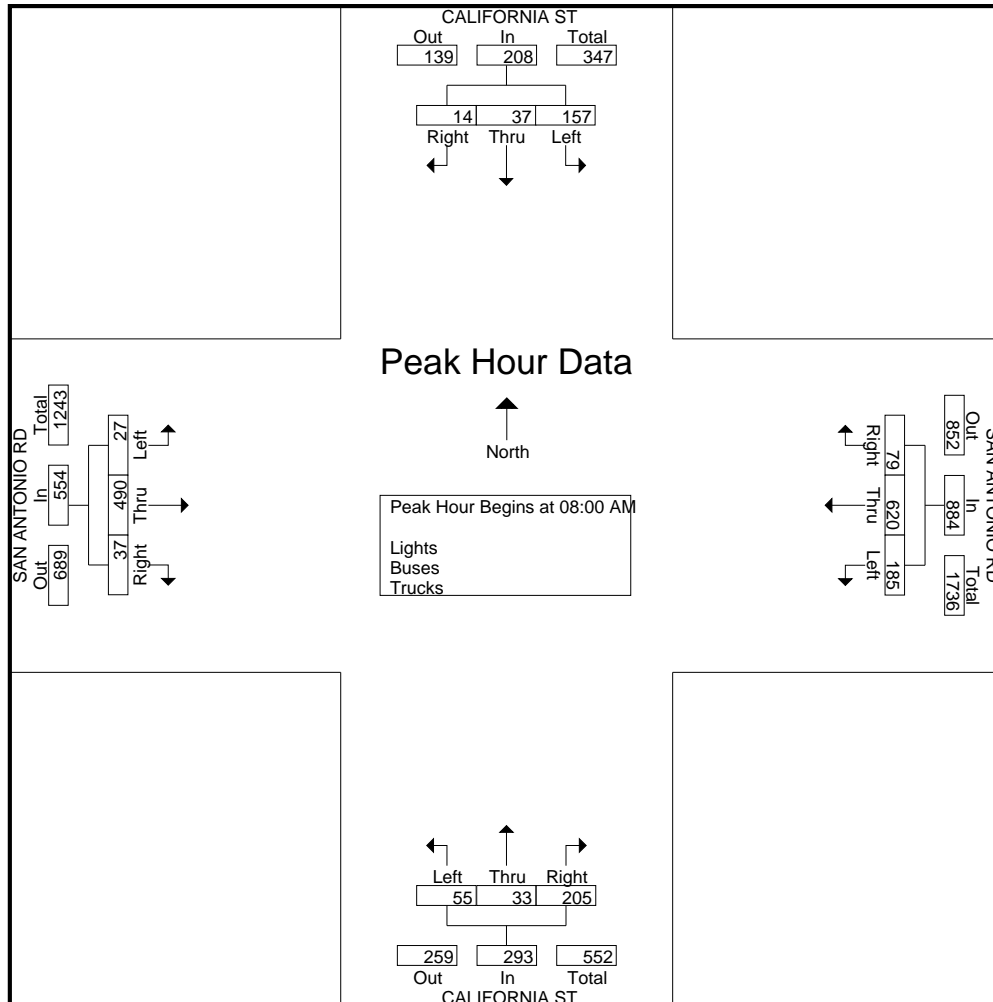

Traffic Data Service

San Jose, CA
(408) 622-4787
tdsbay@cs.com

File Name : 10AM FINAL
Site Code : 00000010
Start Date : 4/27/2021
Page No : 1

Groups Printed- Bikes

Start Time	CALIFORNIA ST Southbound					SAN ANTONIO RD Westbound					CALIFORNIA ST Northbound					SAN ANTONIO RD Eastbound					Int. Total					
	Right	Thru	Left	Peds	App. Total	Right	Thru	Left	Peds	App. Total	Right	Thru	Left	Peds	App. Total	Right	Thru	Left	Peds	App. Total						
07:00 AM	0	0	0	0	0	0	0	0	0	0	0	0	0	0	0	0	0	0	0	0	0	0	0	0	0	0
07:15 AM	0	0	0	0	0	0	0	0	0	0	0	2	0	0	2	0	0	0	0	0	0	0	0	0	0	2
07:30 AM	0	1	0	0	1	0	0	0	0	0	0	0	1	0	1	0	0	0	0	0	0	0	0	0	0	2
07:45 AM	0	0	0	0	0	0	0	0	0	0	0	2	0	0	2	0	0	0	0	0	0	0	0	0	0	2
Total	0	1	0	0	1	0	0	0	0	0	0	4	1	0	5	0	0	0	0	0	0	0	0	0	0	6
08:00 AM	0	0	0	0	0	0	1	0	0	1	0	3	1	0	4	0	0	0	0	0	0	0	0	0	0	5
08:15 AM	0	1	0	0	1	0	0	0	0	0	0	5	0	0	5	0	0	0	0	0	0	0	0	0	0	6
08:30 AM	0	0	0	0	0	0	0	0	0	0	0	2	1	0	3	0	0	0	0	0	0	0	0	0	0	3
08:45 AM	0	0	0	0	0	0	0	0	0	0	0	1	0	0	1	0	1	0	0	0	0	1	0	0	1	2
Total	0	1	0	0	1	0	1	0	0	1	0	11	2	0	13	0	1	0	0	1	0	1	0	0	1	16
Grand Total	0	2	0	0	2	0	1	0	0	1	0	15	3	0	18	0	1	0	0	1	0	1	0	0	1	22
Apprch %	0	100	0	0		0	100	0	0		0	83.3	16.7	0		0	100	0	0		0	100	0	0		
Total %	0	9.1	0	0	9.1	0	4.5	0	0	4.5	0	68.2	13.6	0	81.8	0	4.5	0	0	4.5	0	4.5	0	0	4.5	

Start Time	CALIFORNIA ST Southbound				SAN ANTONIO RD Westbound				CALIFORNIA ST Northbound				SAN ANTONIO RD Eastbound				Int. Total
	Right	Thru	Left	App. Total	Right	Thru	Left	App. Total	Right	Thru	Left	App. Total	Right	Thru	Left	App. Total	
Peak Hour Analysis From 07:00 AM to 08:45 AM - Peak 1 of 1																	
Peak Hour for Entire Intersection Begins at 07:45 AM																	
07:45 AM	0	0	0	0	0	0	0	0	0	2	0	2	0	0	0	0	2
08:00 AM	0	0	0	0	0	1	0	1	0	3	1	4	0	0	0	0	5
08:15 AM	0	1	0	1	0	0	0	0	0	5	0	5	0	0	0	0	6
08:30 AM	0	0	0	0	0	0	0	0	0	2	1	3	0	0	0	0	3
Total Volume	0	1	0	1	0	1	0	1	0	12	2	14	0	0	0	0	16
% App. Total	0	100	0		0	100	0		0	85.7	14.3		0	0	0		
PHF	.000	.250	.000	.250	.000	.250	.000	.250	.000	.600	.500	.700	.000	.000	.000	.000	.667

Traffic Data Service

San Jose, CA
 (408) 622-4787
 tdsbay@cs.com

File Name : 10AM FINAL
 Site Code : 00000010
 Start Date : 4/27/2021
 Page No : 2

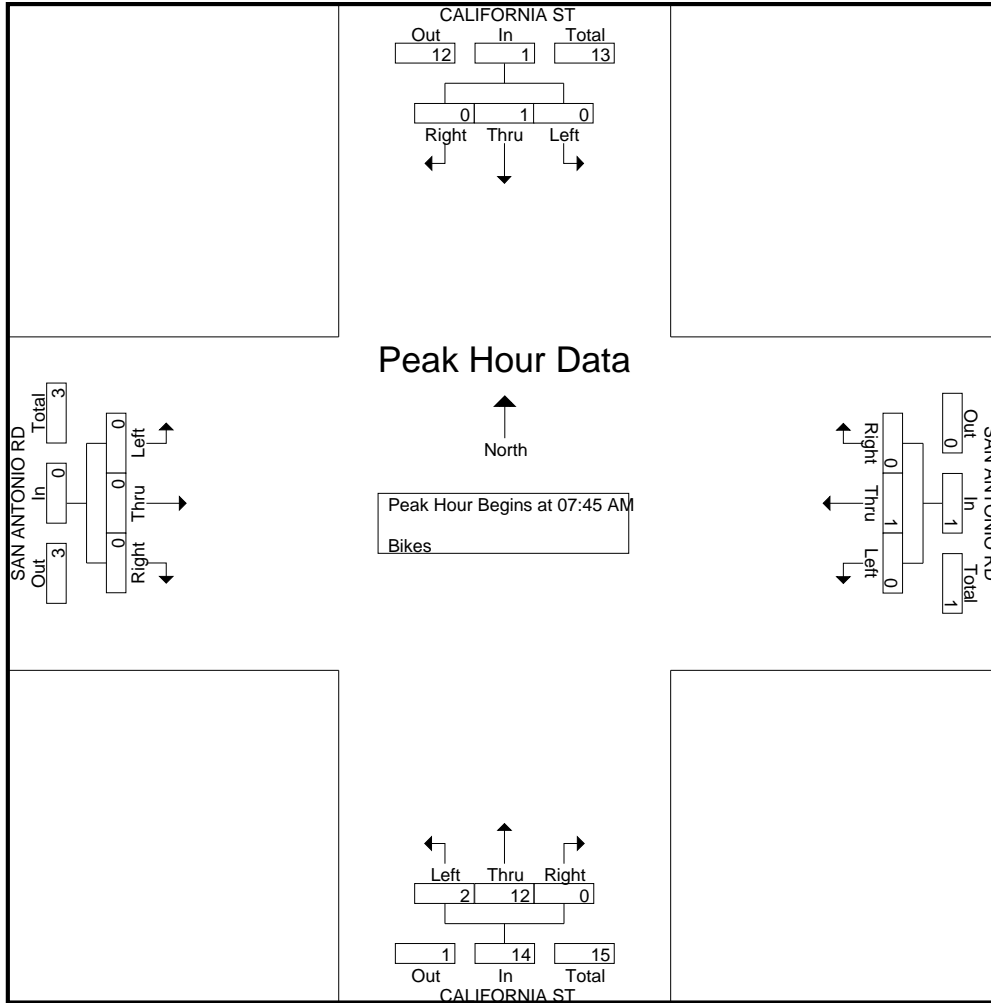

Traffic Data Service

San Jose, CA
 (408) 622-4787
 tdsbay@cs.com

File Name : 10PM FINAL
 Site Code : 00000010
 Start Date : 4/27/2021
 Page No : 1

Groups Printed- Lights - Buses - Trucks

Start Time	CALIFORNIA ST Southbound					SAN ANTONIO RD Westbound					CALIFORNIA ST Northbound					SAN ANTONIO RD Eastbound					Int. Total
	Right	Thru	Left	Peds	App. Total	Right	Thru	Left	Peds	App. Total	Right	Thru	Left	Peds	App. Total	Right	Thru	Left	Peds	App. Total	
04:00 PM	5	11	32	1	49	29	174	80	1	284	91	12	14	2	119	24	162	5	3	194	646
04:15 PM	5	10	33	1	49	26	175	85	0	286	70	11	17	1	99	22	142	11	7	182	616
04:30 PM	1	18	39	3	61	23	169	105	0	297	81	9	18	3	111	16	175	5	5	201	670
04:45 PM	5	17	33	3	58	32	163	80	4	279	73	7	14	1	95	17	165	8	0	190	622
Total	16	56	137	8	217	110	681	350	5	1146	315	39	63	7	424	79	644	29	15	767	2554
05:00 PM	4	15	45	3	67	34	172	88	2	296	113	10	15	3	141	18	169	5	3	195	699
05:15 PM	4	11	25	1	41	35	174	97	3	309	86	10	12	0	108	20	234	4	2	260	718
05:30 PM	4	23	29	2	58	36	172	91	1	300	85	15	16	0	116	9	165	7	2	183	657
05:45 PM	3	15	38	1	57	36	179	93	1	309	72	8	3	1	84	11	174	8	2	195	645
Total	15	64	137	7	223	141	697	369	7	1214	356	43	46	4	449	58	742	24	9	833	2719
Grand Total	31	120	274	15	440	251	1378	719	12	2360	671	82	109	11	873	137	1386	53	24	1600	5273
Apprch %	7	27.3	62.3	3.4		10.6	58.4	30.5	0.5		76.9	9.4	12.5	1.3		8.6	86.6	3.3	1.5		
Total %	0.6	2.3	5.2	0.3	8.3	4.8	26.1	13.6	0.2	44.8	12.7	1.6	2.1	0.2	16.6	2.6	26.3	1	0.5	30.3	
Lights	31	120	270	15	436	247	1375	718	12	2352	668	82	109	11	870	133	1369	53	24	1579	5237
% Lights	100	100	98.5	100	99.1	98.4	99.8	99.9	100	99.7	99.6	100	100	100	99.7	97.1	98.8	100	100	98.7	99.3
Buses	0	0	0	0	0	2	0	0	0	2	2	0	0	0	2	4	5	0	0	9	13
% Buses	0	0	0	0	0	0.8	0	0	0	0.1	0.3	0	0	0	0.2	2.9	0.4	0	0	0.6	0.2
Trucks	0	0	4	0	4	2	3	1	0	6	1	0	0	0	1	0	12	0	0	12	23
% Trucks	0	0	1.5	0	0.9	0.8	0.2	0.1	0	0.3	0.1	0	0	0	0.1	0	0.9	0	0	0.8	0.4

Start Time	CALIFORNIA ST Southbound				SAN ANTONIO RD Westbound				CALIFORNIA ST Northbound				SAN ANTONIO RD Eastbound				Int. Total
	Right	Thru	Left	App. Total	Right	Thru	Left	App. Total	Right	Thru	Left	App. Total	Right	Thru	Left	App. Total	
Peak Hour Analysis From 04:00 PM to 05:45 PM - Peak 1 of 1																	
Peak Hour for Entire Intersection Begins at 05:00 PM																	
05:00 PM	4	15	45	64	34	172	88	294	113	10	15	138	18	169	5	192	688
05:15 PM	4	11	25	40	35	174	97	306	86	10	12	108	20	234	4	258	712
05:30 PM	4	23	29	56	36	172	91	299	85	15	16	116	9	165	7	181	652
05:45 PM	3	15	38	56	36	179	93	308	72	8	3	83	11	174	8	193	640
Total Volume	15	64	137	216	141	697	369	1207	356	43	46	445	58	742	24	824	2692
% App. Total	6.9	29.6	63.4		11.7	57.7	30.6		8.0	9.7	10.3		7	90	2.9		
PHF	.938	.696	.761	.844	.979	.973	.951	.980	.788	.717	.719	.806	.725	.793	.750	.798	.945

Traffic Data Service

San Jose, CA
 (408) 622-4787
 tdsbay@cs.com

File Name : 10PM FINAL
 Site Code : 00000010
 Start Date : 4/27/2021
 Page No : 2

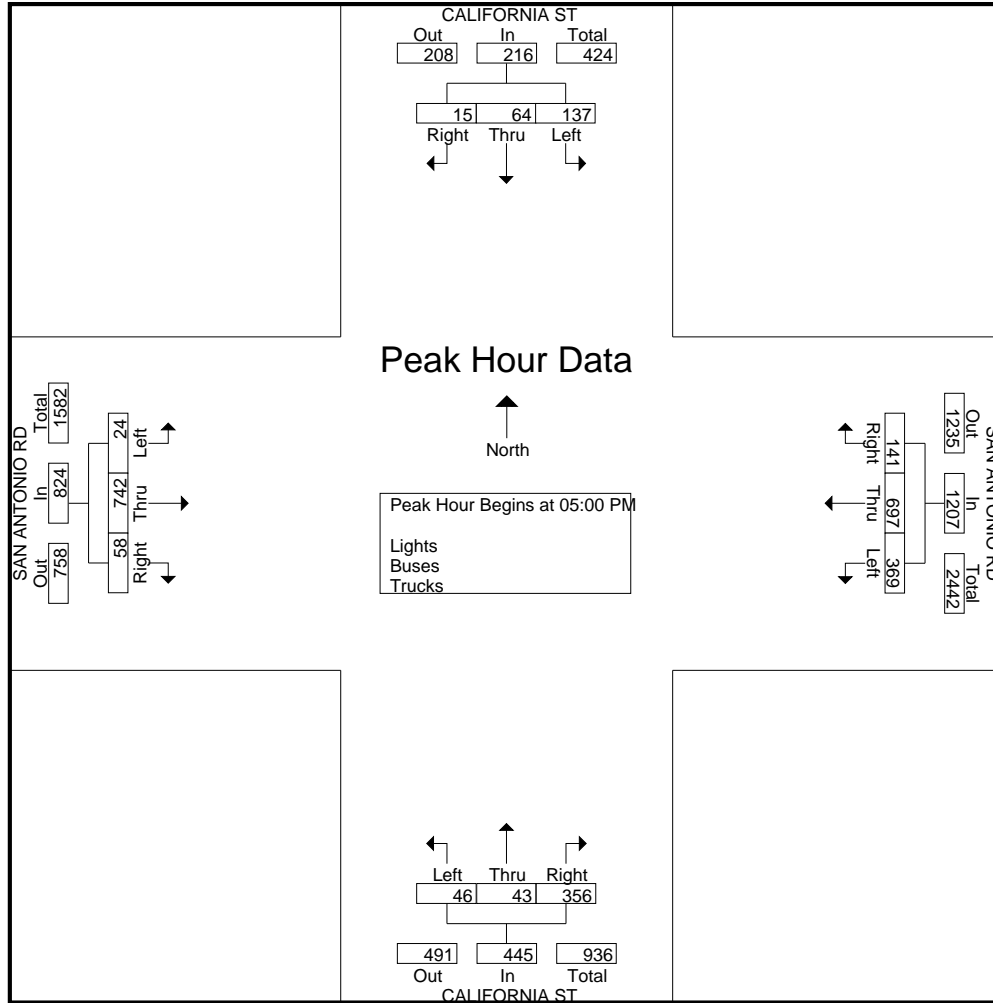

Traffic Data Service

San Jose, CA
 (408) 622-4787
 tdsbay@cs.com

File Name : 10PM FINAL
 Site Code : 00000010
 Start Date : 4/27/2021
 Page No : 1

Groups Printed- Bikes

Start Time	CALIFORNIA ST Southbound					SAN ANTONIO RD Westbound					CALIFORNIA ST Northbound					SAN ANTONIO RD Eastbound					Int. Total					
	Right	Thru	Left	Peds	App. Total	Right	Thru	Left	Peds	App. Total	Right	Thru	Left	Peds	App. Total	Right	Thru	Left	Peds	App. Total						
04:00 PM	0	3	0	0	3	0	0	0	0	0	0	0	0	0	0	0	0	0	0	0	0	0	0	0	0	3
04:15 PM	0	1	0	0	1	0	0	0	0	0	0	0	0	0	0	0	0	0	0	0	0	0	0	0	0	1
04:30 PM	0	0	1	0	1	0	0	0	0	0	0	2	0	0	2	0	0	0	0	0	0	0	0	0	0	3
04:45 PM	0	5	0	0	5	0	0	0	0	0	0	2	0	0	2	0	1	0	0	1	0	0	0	0	1	8
Total	0	9	1	0	10	0	0	0	0	0	0	4	0	0	4	0	1	0	0	1	0	0	0	0	1	15
05:00 PM	0	5	0	0	5	0	0	0	0	0	0	5	0	0	5	0	0	0	0	0	0	0	0	0	0	10
05:15 PM	1	7	0	0	8	1	0	0	0	1	0	0	0	0	0	0	0	0	0	0	0	0	0	0	0	9
05:30 PM	0	5	0	0	5	0	1	0	0	1	0	1	0	0	1	0	0	0	0	0	0	0	0	0	0	7
05:45 PM	0	4	0	0	4	0	0	0	0	0	0	1	1	0	2	0	0	0	0	0	0	0	0	0	0	6
Total	1	21	0	0	22	1	1	0	0	2	0	7	1	0	8	0	0	0	0	0	0	0	0	0	0	32
Grand Total	1	30	1	0	32	1	1	0	0	2	0	11	1	0	12	0	1	0	0	1	0	0	0	0	1	47
Apprch %	3.1	93.8	3.1	0		50	50	0	0		0	91.7	8.3	0		0	100	0	0		0	0	0	0		
Total %	2.1	63.8	2.1	0	68.1	2.1	2.1	0	0	4.3	0	23.4	2.1	0	25.5	0	2.1	0	0	2.1	0	0	0	0	2.1	

Start Time	CALIFORNIA ST Southbound					SAN ANTONIO RD Westbound					CALIFORNIA ST Northbound					SAN ANTONIO RD Eastbound					Int. Total					
	Right	Thru	Left	Peds	App. Total	Right	Thru	Left	Peds	App. Total	Right	Thru	Left	Peds	App. Total	Right	Thru	Left	Peds	App. Total						
04:45 PM	0	5	0	0	5	0	0	0	0	0	0	2	0	0	2	0	1	0	0	1	0	0	0	0	0	8
05:00 PM	0	5	0	0	5	0	0	0	0	0	0	5	0	0	5	0	0	0	0	0	0	0	0	0	0	10
05:15 PM	1	7	0	0	8	1	0	0	0	1	0	0	0	0	0	0	0	0	0	0	0	0	0	0	0	9
05:30 PM	0	5	0	0	5	0	1	0	0	1	0	1	0	0	1	0	0	0	0	0	0	0	0	0	0	7
Total Volume	1	22	0	0	23	1	1	0	0	2	0	8	0	0	8	0	1	0	0	1	0	0	0	0	1	34
% App. Total	4.3	95.7	0	0		50	50	0	0		0	100	0	0		0	100	0	0		0	0	0	0		
PHF	.250	.786	.000	.000	.719	.250	.250	.000	.000	.500	.000	.400	.000	.000	.400	.000	.250	.000	.000	.250	.000	.000	.000	.000	.850	

Peak Hour Analysis From 04:00 PM to 05:45 PM - Peak 1 of 1
 Peak Hour for Entire Intersection Begins at 04:45 PM

Traffic Data Service

San Jose, CA
 (408) 622-4787
 tdsbay@cs.com

File Name : 10PM FINAL
 Site Code : 00000010
 Start Date : 4/27/2021
 Page No : 2

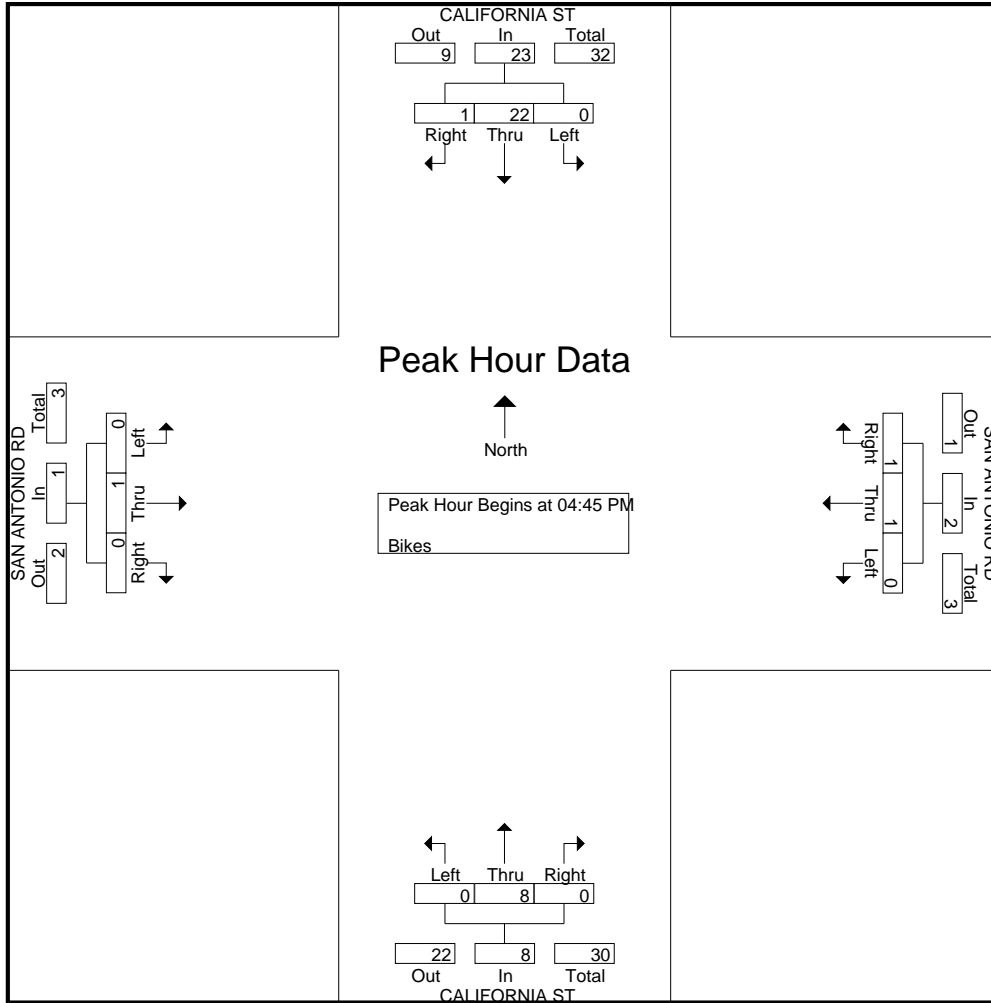

Traffic Data Service

San Jose, CA
 (408) 622-4787
 tdsbay@cs.com

File Name : 11AM FINAL
 Site Code : 00000011
 Start Date : 4/27/2021
 Page No : 1

Groups Printed- Lights - Buses - Trucks

Start Time	CALIFORNIA ST Southbound					PACCHETTI WAY Westbound					CALIFORNIA ST Northbound					DRIVEWAY Eastbound					Int. Total
	Right	Thru	Left	Peds	App. Total	Right	Thru	Left	Peds	App. Total	Right	Thru	Left	Peds	App. Total	Right	Thru	Left	Peds	App. Total	
07:00 AM	20	24	3	5	52	5	3	0	0	8	1	37	1	27	66	1	2	3	0	6	132
07:15 AM	16	21	5	5	47	4	1	0	1	6	0	50	2	19	71	2	1	10	1	14	138
07:30 AM	18	25	10	0	53	9	3	0	2	14	2	49	3	12	66	3	1	8	1	13	146
07:45 AM	14	32	1	1	48	9	4	5	0	18	2	50	2	7	61	2	1	14	1	18	145
Total	68	102	19	11	200	27	11	5	3	46	5	186	8	65	264	8	5	35	3	51	561
08:00 AM	15	28	5	6	54	20	1	0	1	22	0	38	1	17	56	0	2	7	0	9	141
08:15 AM	23	27	3	2	55	7	0	1	1	9	1	51	1	10	63	3	2	13	1	19	146
08:30 AM	17	46	12	1	76	13	0	1	1	15	0	62	3	5	70	1	0	8	2	11	172
08:45 AM	12	32	7	2	53	13	1	1	3	18	0	48	4	10	62	3	0	13	3	19	152
Total	67	133	27	11	238	53	2	3	6	64	1	199	9	42	251	7	4	41	6	58	611
Grand Total	135	235	46	22	438	80	13	8	9	110	6	385	17	107	515	15	9	76	9	109	1172
Apprch %	30.8	53.7	10.5	5		72.7	11.8	7.3	8.2		1.2	74.8	3.3	20.8		13.8	8.3	69.7	8.3		
Total %	11.5	20.1	3.9	1.9	37.4	6.8	1.1	0.7	0.8	9.4	0.5	32.8	1.5	9.1	43.9	1.3	0.8	6.5	0.8	9.3	
Lights	133	214	33	22	402	72	13	5	9	99	2	377	16	107	502	14	7	75	9	105	1108
% Lights	98.5	91.1	71.7	100	91.8	90	100	62.5	100	90	33.3	97.9	94.1	100	97.5	93.3	77.8	98.7	100	96.3	94.5
Buses	1	5	0	0	6	0	0	0	0	0	0	2	0	0	2	0	0	0	0	0	8
% Buses	0.7	2.1	0	0	1.4	0	0	0	0	0	0	0.5	0	0	0.4	0	0	0	0	0	0.7
Trucks	1	16	13	0	30	8	0	3	0	11	4	6	1	0	11	1	2	1	0	4	56
% Trucks	0.7	6.8	28.3	0	6.8	10	0	37.5	0	10	66.7	1.6	5.9	0	2.1	6.7	22.2	1.3	0	3.7	4.8

Start Time	CALIFORNIA ST Southbound				PACCHETTI WAY Westbound				CALIFORNIA ST Northbound				DRIVEWAY Eastbound				Int. Total
	Right	Thru	Left	App. Total	Right	Thru	Left	App. Total	Right	Thru	Left	App. Total	Right	Thru	Left	App. Total	
Peak Hour Analysis From 07:00 AM to 08:45 AM - Peak 1 of 1																	
Peak Hour for Entire Intersection Begins at 07:45 AM																	
07:45 AM	14	32	1	47	9	4	5	18	2	50	2	54	2	1	14	17	136
08:00 AM	15	28	5	48	20	1	0	21	0	38	1	39	0	2	7	9	117
08:15 AM	23	27	3	53	7	0	1	8	1	51	1	53	3	2	13	18	132
08:30 AM	17	46	12	75	13	0	1	14	0	62	3	65	1	0	8	9	163
Total Volume	69	133	21	223	49	5	7	61	3	201	7	211	6	5	42	53	548
% App. Total	30.9	59.6	9.4		80.3	8.2	11.5		1.4	95.3	3.3		11.3	9.4	79.2		
PHF	.750	.723	.438	.743	.613	.313	.350	.726	.375	.810	.583	.812	.500	.625	.750	.736	.840

Traffic Data Service

San Jose, CA
 (408) 622-4787
 tdsbay@cs.com

File Name : 11AM FINAL
 Site Code : 00000011
 Start Date : 4/27/2021
 Page No : 2

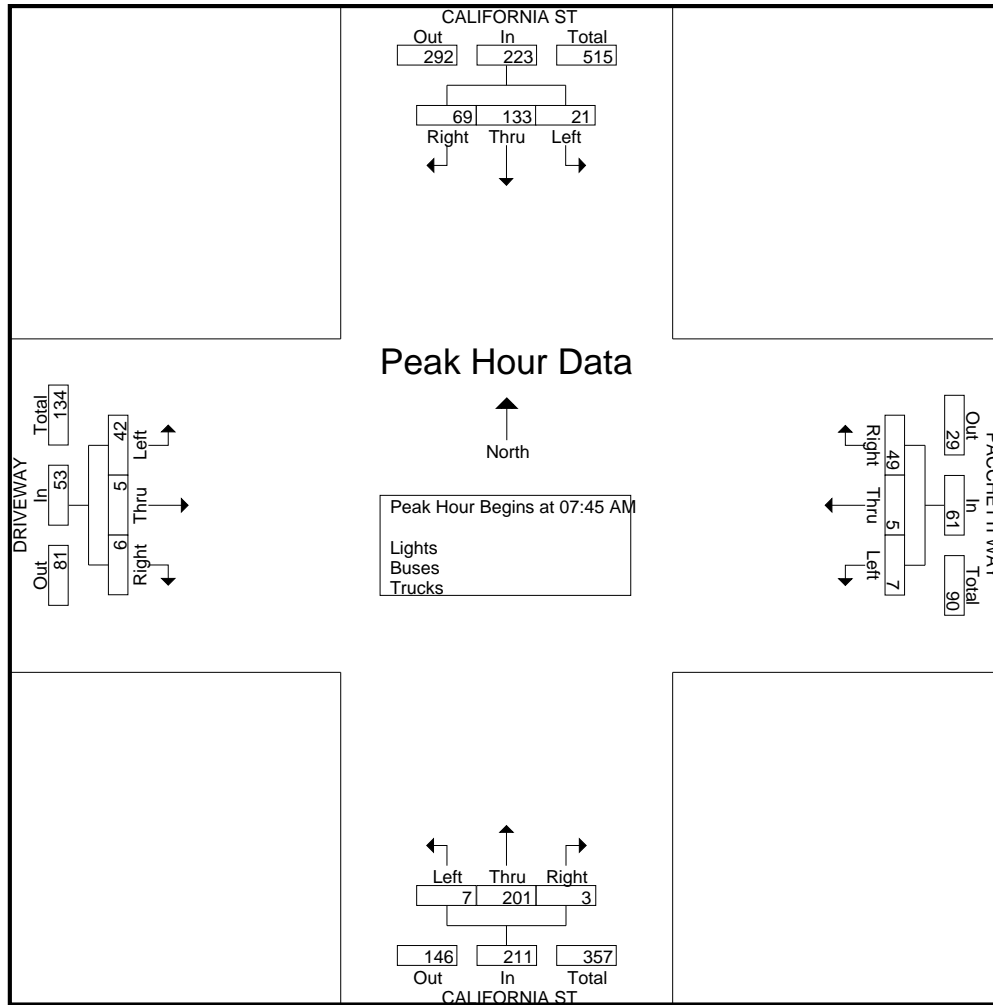

Traffic Data Service

San Jose, CA
 (408) 622-4787
 tdsbay@cs.com

File Name : 11AM FINAL
 Site Code : 00000011
 Start Date : 4/27/2021
 Page No : 1

Groups Printed- Bikes

Start Time	CALIFORNIA ST Southbound					PACCHETTI WAY Westbound					CALIFORNIA ST Northbound					DRIVEWAY Eastbound					Int. Total
	Right	Thru	Left	Peds	App. Total	Right	Thru	Left	Peds	App. Total	Right	Thru	Left	Peds	App. Total	Right	Thru	Left	Peds	App. Total	
07:00 AM	0	0	0	0	0	0	0	0	0	0	0	0	0	0	0	0	0	0	0	0	0
07:15 AM	0	0	0	0	0	0	1	0	0	1	0	0	0	0	0	0	0	0	0	0	0
07:30 AM	0	1	0	0	1	0	0	0	0	0	0	0	0	0	0	0	1	0	0	1	2
07:45 AM	0	0	0	0	0	0	1	0	0	1	0	2	0	0	2	0	0	0	0	0	3
Total	0	1	0	0	1	0	2	0	0	2	0	2	0	0	2	0	1	0	0	1	6
08:00 AM	0	0	0	0	0	0	1	0	0	1	0	4	0	0	4	0	0	0	0	0	5
08:15 AM	1	0	0	0	1	0	0	0	0	0	0	4	0	0	4	0	0	0	0	0	5
08:30 AM	0	0	0	0	0	1	1	0	0	2	0	1	0	0	1	0	0	0	0	0	3
08:45 AM	0	0	0	0	0	0	0	0	0	0	0	1	0	0	1	0	1	0	0	1	2
Total	1	0	0	0	1	1	2	0	0	3	0	10	0	0	10	0	1	0	0	1	15
Grand Total	1	1	0	0	2	1	4	0	0	5	0	12	0	0	12	0	2	0	0	2	21
Apprch %	50	50	0	0		20	80	0	0		0	100	0	0		0	100	0	0		
Total %	4.8	4.8	0	0	9.5	4.8	19	0	0	23.8	0	57.1	0	0	57.1	0	9.5	0	0	9.5	

Start Time	CALIFORNIA ST Southbound				PACCHETTI WAY Westbound				CALIFORNIA ST Northbound				DRIVEWAY Eastbound				Int. Total
	Right	Thru	Left	App. Total	Right	Thru	Left	App. Total	Right	Thru	Left	App. Total	Right	Thru	Left	App. Total	
Peak Hour Analysis From 07:00 AM to 08:45 AM - Peak 1 of 1																	
Peak Hour for Entire Intersection Begins at 07:45 AM																	
07:45 AM	0	0	0	0	0	1	0	1	0	2	0	2	0	0	0	0	3
08:00 AM	0	0	0	0	0	1	0	1	0	4	0	4	0	0	0	0	5
08:15 AM	1	0	0	1	0	0	0	0	0	4	0	4	0	0	0	0	5
08:30 AM	0	0	0	0	1	1	0	2	0	1	0	1	0	0	0	0	3
Total Volume	1	0	0	1	1	3	0	4	0	11	0	11	0	0	0	0	16
% App. Total	100	0	0		25	75	0		0	100	0		0	0	0		
PHF	.250	.000	.000	.250	.250	.750	.000	.500	.000	.688	.000	.688	.000	.000	.000	.000	.800

Traffic Data Service

San Jose, CA
 (408) 622-4787
 tdsbay@cs.com

File Name : 11AM FINAL
 Site Code : 00000011
 Start Date : 4/27/2021
 Page No : 2

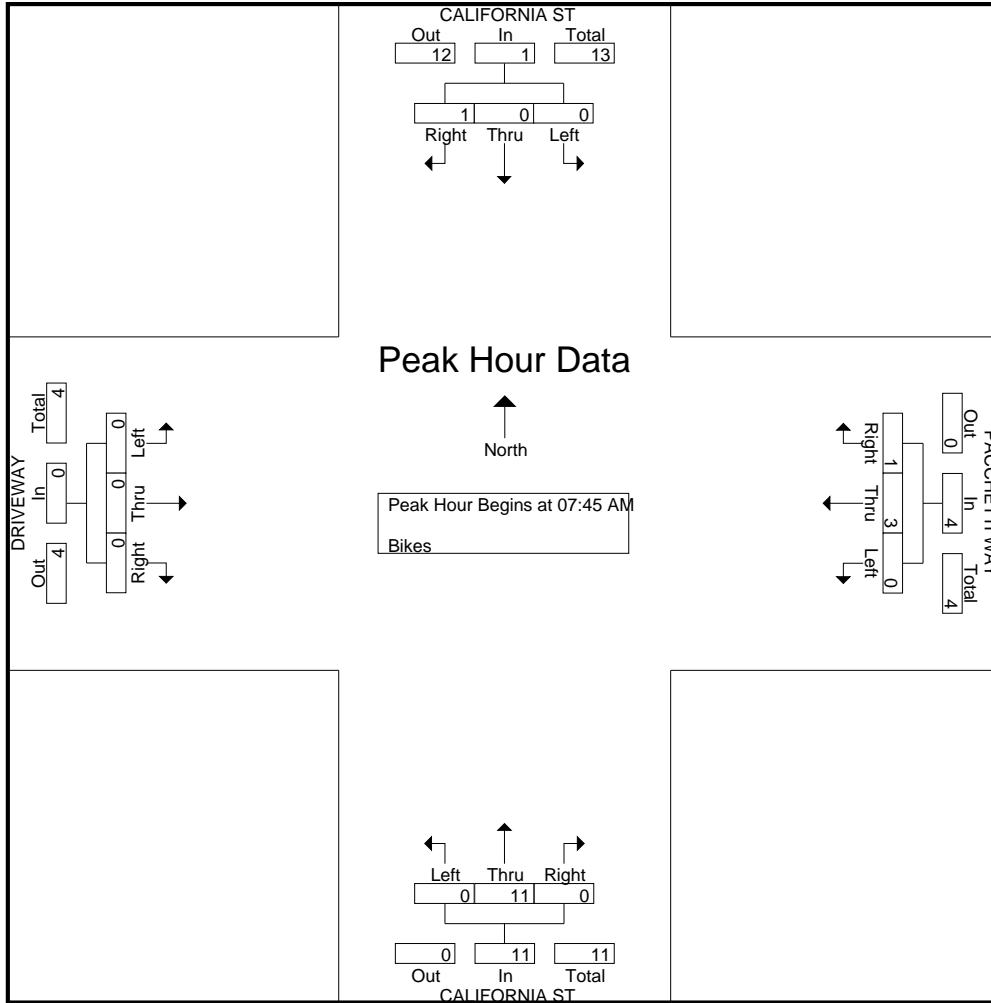

Traffic Data Service

San Jose, CA
 (408) 622-4787
 tdsbay@cs.com

File Name : 11PM FINAL
 Site Code : 00000011
 Start Date : 4/27/2021
 Page No : 1

Groups Printed- Lights - Buses - Trucks

Start Time	CALIFORNIA ST Southbound					PACCHETTI WAY Westbound					CALIFORNIA ST Northbound					DRIVEWAY Eastbound					Int. Total
	Right	Thru	Left	Peds	App. Total	Right	Thru	Left	Peds	App. Total	Right	Thru	Left	Peds	App. Total	Right	Thru	Left	Peds	App. Total	
04:00 PM	40	67	4	0	111	8	1	0	5	14	1	74	3	7	85	4	1	26	3	34	244
04:15 PM	39	60	3	4	106	9	2	1	1	13	3	70	10	7	90	6	1	31	5	43	252
04:30 PM	35	76	8	6	125	17	2	1	1	21	0	53	8	5	66	7	3	24	2	36	248
04:45 PM	41	72	1	1	115	7	1	1	2	11	0	63	4	15	82	2	2	27	0	31	239
Total	155	275	16	11	457	41	6	3	9	59	4	260	25	34	323	19	7	108	10	144	983
05:00 PM	35	81	4	3	123	19	1	1	6	27	2	83	2	2	89	6	0	39	1	46	285
05:15 PM	37	73	1	5	116	7	1	0	0	8	0	64	3	12	79	6	2	38	3	49	252
05:30 PM	27	84	3	7	121	10	1	3	1	15	0	71	7	5	83	6	4	29	2	41	260
05:45 PM	43	74	4	5	126	12	1	0	1	14	1	56	11	15	83	6	0	20	4	30	253
Total	142	312	12	20	486	48	4	4	8	64	3	274	23	34	334	24	6	126	10	166	1050
Grand Total	297	587	28	31	943	89	10	7	17	123	7	534	48	68	657	43	13	234	20	310	2033
Apprch %	31.5	62.2	3	3.3		72.4	8.1	5.7	13.8		1.1	81.3	7.3	10.4		13.9	4.2	75.5	6.5		
Total %	14.6	28.9	1.4	1.5	46.4	4.4	0.5	0.3	0.8	6.1	0.3	26.3	2.4	3.3	32.3	2.1	0.6	11.5	1	15.2	
Lights	296	583	28	31	938	88	10	7	17	122	7	532	48	68	655	43	13	234	20	310	2025
% Lights	99.7	99.3	100	100	99.5	98.9	100	100	100	99.2	100	99.6	100	100	99.7	100	100	100	100	100	99.6
Buses	0	4	0	0	4	0	0	0	0	0	0	2	0	0	2	0	0	0	0	0	6
% Buses	0	0.7	0	0	0.4	0	0	0	0	0	0	0.4	0	0	0.3	0	0	0	0	0	0.3
Trucks	1	0	0	0	1	1	0	0	0	1	0	0	0	0	0	0	0	0	0	0	2
% Trucks	0.3	0	0	0	0.1	1.1	0	0	0	0.8	0	0	0	0	0	0	0	0	0	0	0.1

Start Time	CALIFORNIA ST Southbound				PACCHETTI WAY Westbound				CALIFORNIA ST Northbound				DRIVEWAY Eastbound				Int. Total
	Right	Thru	Left	App. Total	Right	Thru	Left	App. Total	Right	Thru	Left	App. Total	Right	Thru	Left	App. Total	
Peak Hour Analysis From 04:00 PM to 05:45 PM - Peak 1 of 1																	
Peak Hour for Entire Intersection Begins at 05:00 PM																	
05:00 PM	35	81	4	120	19	1	1	21	2	83	2	87	6	0	39	45	273
05:15 PM	37	73	1	111	7	1	0	8	0	64	3	67	6	2	38	46	232
05:30 PM	27	84	3	114	10	1	3	14	0	71	7	78	6	4	29	39	245
05:45 PM	43	74	4	121	12	1	0	13	1	56	11	68	6	0	20	26	228
Total Volume	142	312	12	466	48	4	4	56	3	274	23	300	24	6	126	156	978
% App. Total	30.5	67	2.6		85.7	7.1	7.1		1	91.3	7.7		15.4	3.8	80.8		
PHF	.826	.929	.750	.963	.632	1.00	.333	.667	.375	.825	.523	.862	1.00	.375	.808	.848	.896

Traffic Data Service

San Jose, CA
 (408) 622-4787
 tdsbay@cs.com

File Name : 11PM FINAL
 Site Code : 00000011
 Start Date : 4/27/2021
 Page No : 2

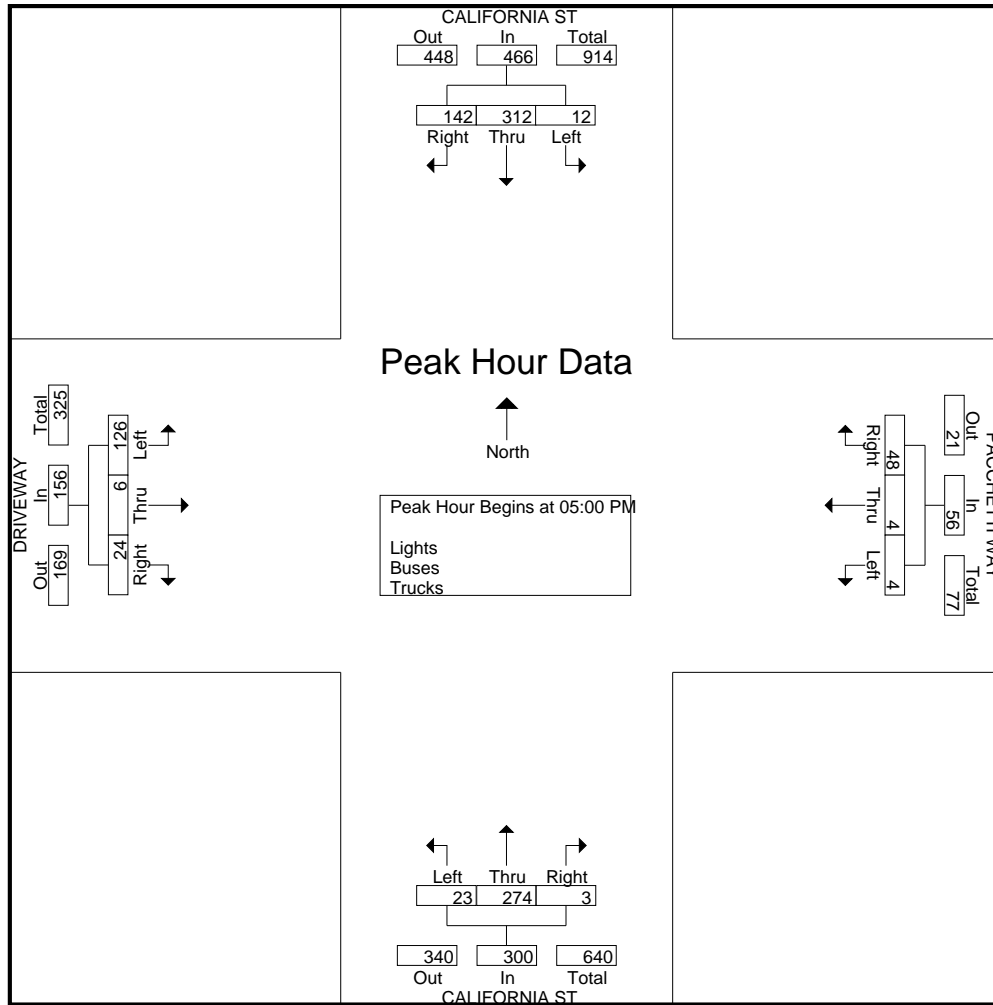

Traffic Data Service

San Jose, CA
 (408) 622-4787
 tdsbay@cs.com

File Name : 11PM FINAL
 Site Code : 00000011
 Start Date : 4/27/2021
 Page No : 1

Groups Printed- Bikes

Start Time	CALIFORNIA ST Southbound					PACCHETTI WAY Westbound					CALIFORNIA ST Northbound					DRIVEWAY Eastbound					Int. Total		
	Right	Thru	Left	Peds	App. Total	Right	Thru	Left	Peds	App. Total	Right	Thru	Left	Peds	App. Total	Right	Thru	Left	Peds	App. Total			
04:00 PM	1	3	0	0	4	0	0	0	0	0	0	0	0	0	0	0	0	0	0	0	0	4	
04:15 PM	0	0	0	0	0	0	0	0	0	0	0	0	0	0	0	0	0	0	0	0	0	0	0
04:30 PM	0	3	2	0	5	0	0	0	0	0	0	0	0	0	0	0	0	0	0	0	0	5	
04:45 PM	1	4	0	0	5	1	2	0	0	3	0	1	0	0	1	1	0	0	0	0	1	10	
Total	2	10	2	0	14	1	2	0	0	3	0	1	0	0	1	1	0	0	0	0	1	19	
05:00 PM	2	4	0	0	6	5	0	0	0	5	3	0	1	0	4	1	0	0	0	0	1	16	
05:15 PM	0	6	0	0	6	0	0	0	0	0	0	0	0	0	0	0	2	0	0	0	2	8	
05:30 PM	1	5	0	0	6	0	2	0	0	2	0	1	0	0	1	1	0	0	0	0	1	10	
05:45 PM	1	3	0	0	4	1	0	0	0	1	0	1	0	0	1	0	1	0	0	0	1	7	
Total	4	18	0	0	22	6	2	0	0	8	3	2	1	0	6	2	3	0	0	0	5	41	
Grand Total	6	28	2	0	36	7	4	0	0	11	3	3	1	0	7	3	3	0	0	0	6	60	
Apprch %	16.7	77.8	5.6	0		63.6	36.4	0	0		42.9	42.9	14.3	0		50	50	0	0				
Total %	10	46.7	3.3	0	60	11.7	6.7	0	0	18.3	5	5	1.7	0	11.7	5	5	0	0		10		

Start Time	CALIFORNIA ST Southbound					PACCHETTI WAY Westbound					CALIFORNIA ST Northbound					DRIVEWAY Eastbound					Int. Total	
	Right	Thru	Left	Peds	App. Total	Right	Thru	Left	Peds	App. Total	Right	Thru	Left	Peds	App. Total	Right	Thru	Left	Peds	App. Total		
04:45 PM	1	4	0	0	5	1	2	0	0	3	0	1	0	0	1	1	0	0	0	0	1	10
05:00 PM	2	4	0	0	6	5	0	0	0	5	3	0	1	0	4	1	0	0	0	0	1	16
05:15 PM	0	6	0	0	6	0	0	0	0	0	0	0	0	0	0	0	2	0	0	0	2	8
05:30 PM	1	5	0	0	6	0	2	0	0	2	0	1	0	0	1	1	0	0	0	0	1	10
Total Volume	4	19	0	0	23	6	4	0	0	10	3	2	1	0	6	3	2	0	0	0	5	44
% App. Total	17.4	82.6	0	0		60	40	0	0		50	33.3	16.7	0		60	40	0	0			
PHF	.500	.792	.000	.000	.958	.300	.500	.000	.000	.500	.250	.500	.250	.000	.375	.750	.250	.000	.000	.000	.625	.688

Peak Hour Analysis From 04:00 PM to 05:45 PM - Peak 1 of 1

Peak Hour for Entire Intersection Begins at 04:45 PM

Traffic Data Service

San Jose, CA
 (408) 622-4787
 tdsbay@cs.com

File Name : 11PM FINAL
 Site Code : 00000011
 Start Date : 4/27/2021
 Page No : 2

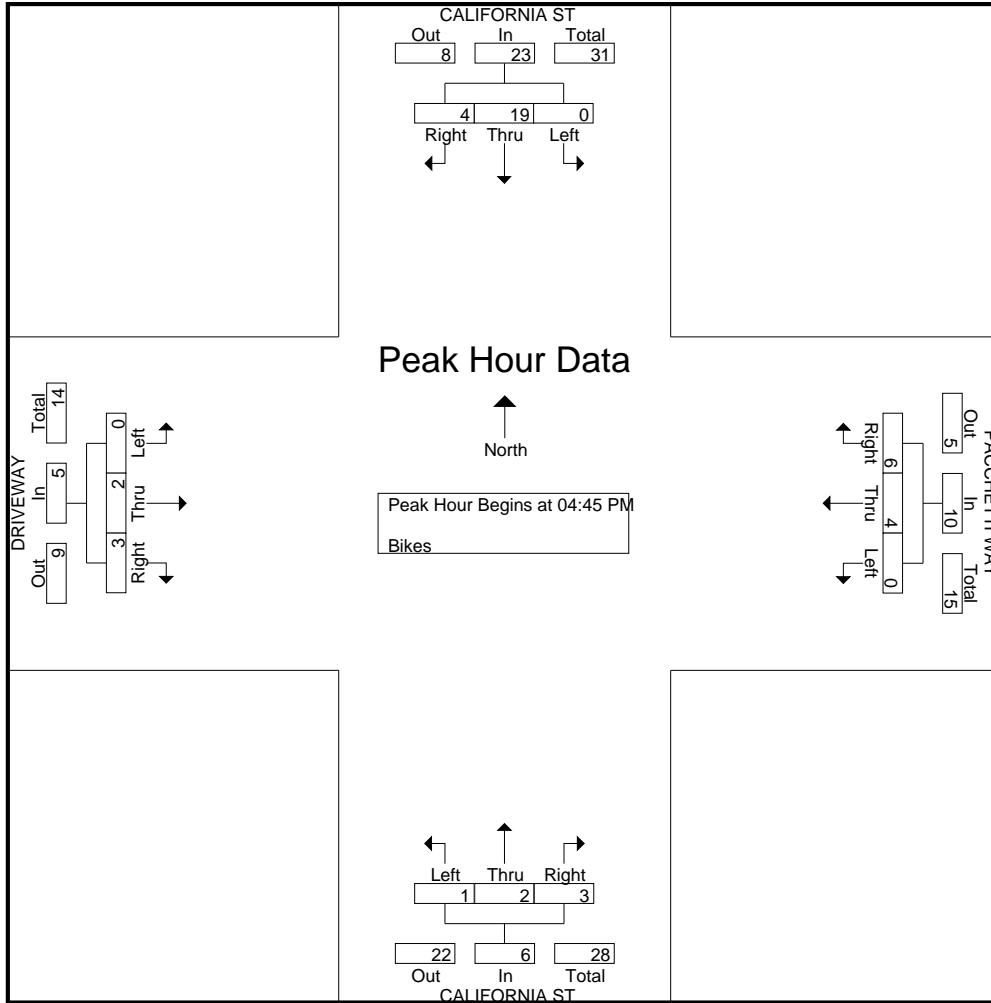

Traffic Data Service

San Jose, CA
 (408) 622-4787
 tdsbay@cs.com

File Name : 12AM FINAL
 Site Code : 00000012
 Start Date : 4/27/2021
 Page No : 1

Groups Printed- Lights - Buses - Trucks

Start Time	CALIFORNIA ST Southbound					SHOWERS DR Westbound					CALIFORNIA ST Northbound					SHOWERS DR Eastbound					Int. Total
	Right	Thru	Left	Peds	App. Total	Right	Thru	Left	Peds	App. Total	Right	Thru	Left	Peds	App. Total	Right	Thru	Left	Peds	App. Total	
07:00 AM	8	15	0	0	23	6	5	0	0	11	0	32	8	0	40	6	1	7	0	14	88
07:15 AM	2	11	0	1	14	5	9	3	1	18	4	34	2	0	40	5	1	10	1	17	89
07:30 AM	7	16	1	2	26	5	5	3	1	14	0	43	10	0	53	7	3	4	0	14	107
07:45 AM	7	27	0	0	34	10	10	4	0	24	3	32	16	1	52	10	2	13	1	26	136
Total	24	69	1	3	97	26	29	10	2	67	7	141	36	1	185	28	7	34	2	71	420
08:00 AM	11	22	4	0	37	6	22	8	1	37	3	35	18	0	56	8	3	9	1	21	151
08:15 AM	5	29	2	3	39	12	12	2	7	33	2	50	13	2	67	8	10	15	1	34	173
08:30 AM	10	33	2	2	47	5	7	3	2	17	3	41	24	0	68	10	13	16	0	39	171
08:45 AM	9	24	1	6	40	9	8	2	4	23	7	33	27	1	68	15	3	20	0	38	169
Total	35	108	9	11	163	32	49	15	14	110	15	159	82	3	259	41	29	60	2	132	664
Grand Total	59	177	10	14	260	58	78	25	16	177	22	300	118	4	444	69	36	94	4	203	1084
Apprch %	22.7	68.1	3.8	5.4		32.8	44.1	14.1	9		5	67.6	26.6	0.9		34	17.7	46.3	2		
Total %	5.4	16.3	0.9	1.3	24	5.4	7.2	2.3	1.5	16.3	2	27.7	10.9	0.4	41	6.4	3.3	8.7	0.4	18.7	
Lights	53	161	10	14	238	56	73	25	16	170	21	291	107	4	423	63	35	91	4	193	1024
% Lights	89.8	91	100	100	91.5	96.6	93.6	100	100	96	95.5	97	90.7	100	95.3	91.3	97.2	96.8	100	95.1	94.5
Buses	0	6	0	0	6	0	4	0	0	4	0	1	8	0	9	4	0	1	0	5	24
% Buses	0	3.4	0	0	2.3	0	5.1	0	0	2.3	0	0.3	6.8	0	2	5.8	0	1.1	0	2.5	2.2
Trucks	6	10	0	0	16	2	1	0	0	3	1	8	3	0	12	2	1	2	0	5	36
% Trucks	10.2	5.6	0	0	6.2	3.4	1.3	0	0	1.7	4.5	2.7	2.5	0	2.7	2.9	2.8	2.1	0	2.5	3.3

Start Time	CALIFORNIA ST Southbound				SHOWERS DR Westbound				CALIFORNIA ST Northbound				SHOWERS DR Eastbound				Int. Total
	Right	Thru	Left	App. Total	Right	Thru	Left	App. Total	Right	Thru	Left	App. Total	Right	Thru	Left	App. Total	
Peak Hour Analysis From 07:00 AM to 08:45 AM - Peak 1 of 1																	
Peak Hour for Entire Intersection Begins at 08:00 AM																	
08:00 AM	11	22	4	37	6	22	8	36	3	35	18	56	8	3	9	20	149
08:15 AM	5	29	2	36	12	12	2	26	2	50	13	65	8	10	15	33	160
08:30 AM	10	33	2	45	5	7	3	15	3	41	24	68	10	13	16	39	167
08:45 AM	9	24	1	34	9	8	2	19	7	33	27	67	15	3	20	38	158
Total Volume	35	108	9	152	32	49	15	96	15	159	82	256	41	29	60	130	634
% App. Total	23	71.1	5.9		33.3	51	15.6		5.9	62.1	32		31.5	22.3	46.2		
PHF	.795	.818	.563	.844	.667	.557	.469	.667	.536	.795	.759	.941	.683	.558	.750	.833	.949

Traffic Data Service

San Jose, CA
 (408) 622-4787
 tdsbay@cs.com

File Name : 12AM FINAL
 Site Code : 00000012
 Start Date : 4/27/2021
 Page No : 2

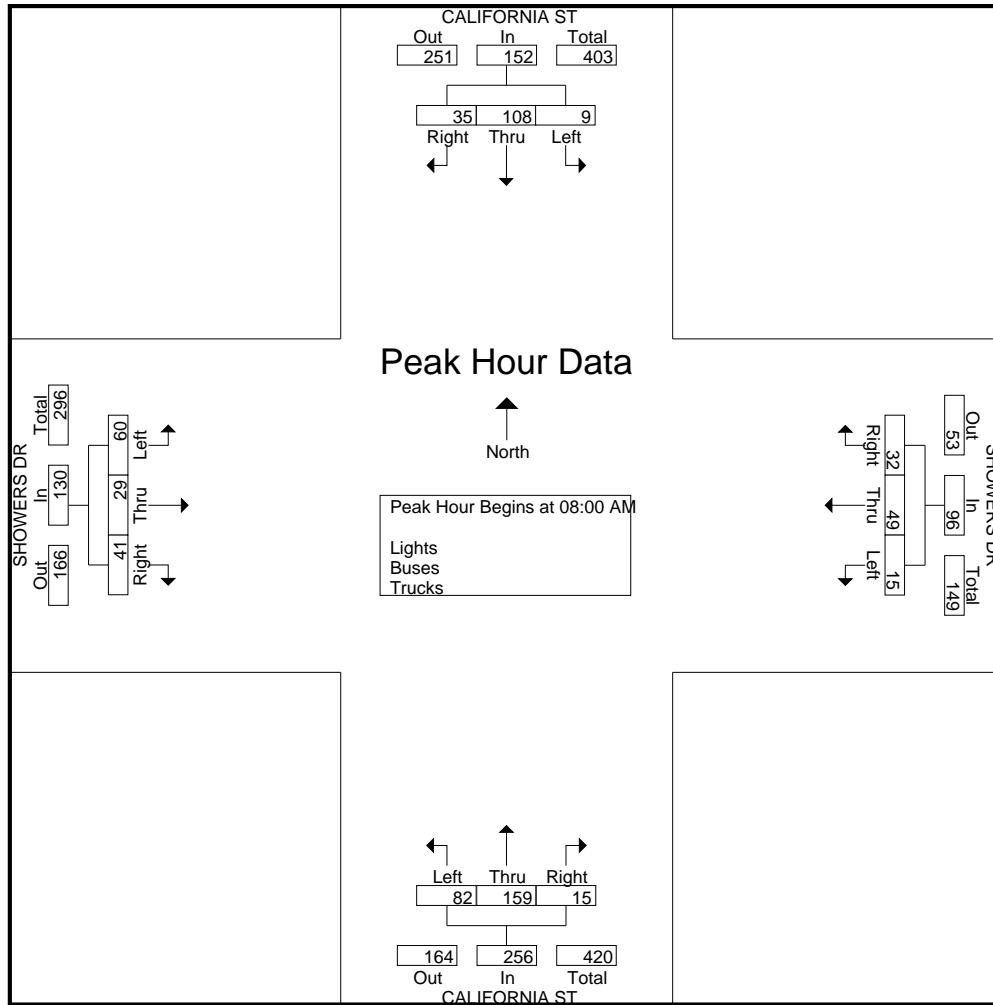

Traffic Data Service

San Jose, CA
 (408) 622-4787
 tdsbay@cs.com

File Name : 12AM FINAL
 Site Code : 00000012
 Start Date : 4/27/2021
 Page No : 1

Groups Printed- Bikes

Start Time	CALIFORNIA ST Southbound					SHOWERS DR Westbound					CALIFORNIA ST Northbound					SHOWERS DR Eastbound					Int. Total
	Right	Thru	Left	Peds	App. Total	Right	Thru	Left	Peds	App. Total	Right	Thru	Left	Peds	App. Total	Right	Thru	Left	Peds	App. Total	
07:00 AM	0	0	0	0	0	0	1	0	0	1	0	2	0	0	2	0	0	0	0	0	3
07:15 AM	0	0	0	0	0	0	1	0	0	1	1	2	0	0	3	0	0	0	0	0	4
07:30 AM	0	0	0	0	0	0	0	0	0	0	0	1	0	0	1	0	0	0	0	0	1
07:45 AM	0	1	0	0	1	0	0	1	0	1	0	3	0	0	3	0	0	0	0	0	5
Total	0	1	0	0	1	0	2	1	0	3	1	8	0	0	9	0	0	0	0	0	13
08:00 AM	0	0	0	0	0	0	0	0	0	0	0	2	0	0	2	0	0	0	0	0	2
08:15 AM	0	0	0	0	0	0	0	0	0	0	0	1	0	0	1	0	2	0	0	2	3
08:30 AM	0	0	0	0	0	0	0	0	0	0	1	0	0	0	1	1	0	0	0	1	2
08:45 AM	0	0	0	0	0	0	1	0	0	1	1	0	0	0	1	0	0	0	0	0	2
Total	0	0	0	0	0	0	1	0	0	1	2	3	0	0	5	1	2	0	0	3	9
Grand Total	0	1	0	0	1	0	3	1	0	4	3	11	0	0	14	1	2	0	0	3	22
Apprch %	0	100	0	0		0	75	25	0		21.4	78.6	0	0		33.3	66.7	0	0		
Total %	0	4.5	0	0	4.5	0	13.6	4.5	0	18.2	13.6	50	0	0	63.6	4.5	9.1	0	0	13.6	

Start Time	CALIFORNIA ST Southbound				SHOWERS DR Westbound				CALIFORNIA ST Northbound				SHOWERS DR Eastbound				Int. Total
	Right	Thru	Left	App. Total	Right	Thru	Left	App. Total	Right	Thru	Left	App. Total	Right	Thru	Left	App. Total	
Peak Hour Analysis From 07:00 AM to 08:45 AM - Peak 1 of 1																	
Peak Hour for Entire Intersection Begins at 07:00 AM																	
07:00 AM	0	0	0	0	0	1	0	1	0	2	0	2	0	0	0	0	3
07:15 AM	0	0	0	0	0	1	0	1	1	2	0	3	0	0	0	0	4
07:30 AM	0	0	0	0	0	0	0	0	0	1	0	1	0	0	0	0	1
07:45 AM	0	1	0	1	0	0	1	1	0	3	0	3	0	0	0	0	5
Total Volume	0	1	0	1	0	2	1	3	1	8	0	9	0	0	0	0	13
% App. Total	0	100	0		0	66.7	33.3		11.1	88.9	0		0	0	0		
PHF	.000	.250	.000	.250	.000	.500	.250	.750	.250	.667	.000	.750	.000	.000	.000	.000	.650

Traffic Data Service

San Jose, CA
 (408) 622-4787
 tdsbay@cs.com

File Name : 12AM FINAL
 Site Code : 00000012
 Start Date : 4/27/2021
 Page No : 2

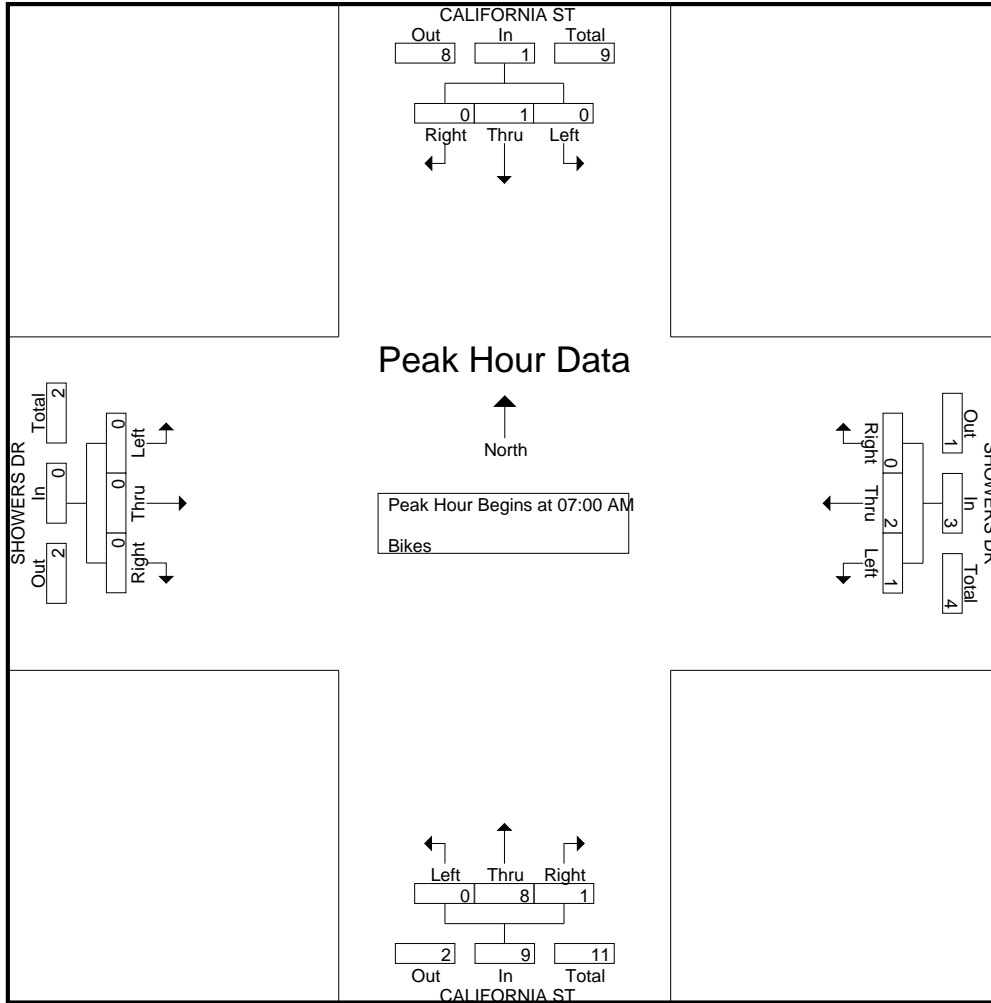

Traffic Data Service

San Jose, CA
 (408) 622-4787
 tdsbay@cs.com

File Name : 12PM FINAL
 Site Code : 00000012
 Start Date : 4/27/2021
 Page No : 1

Groups Printed- Lights - Buses - Trucks

Start Time	CALIFORNIA ST Southbound					SHOWERS DR Westbound					CALIFORNIA ST Northbound					SHOWERS DR Eastbound					Int. Total
	Right	Thru	Left	Peds	App. Total	Right	Thru	Left	Peds	App. Total	Right	Thru	Left	Peds	App. Total	Right	Thru	Left	Peds	App. Total	
04:00 PM	20	61	2	2	85	4	8	6	6	24	0	45	23	4	72	48	9	26	7	90	271
04:15 PM	15	50	2	3	70	7	10	9	1	27	6	54	30	3	93	33	8	20	4	65	255
04:30 PM	18	72	3	4	97	10	8	16	6	40	4	49	24	2	79	30	5	22	3	60	276
04:45 PM	13	57	5	4	79	5	12	13	4	34	2	43	28	2	75	46	13	18	4	81	269
Total	66	240	12	13	331	26	38	44	17	125	12	191	105	11	319	157	35	86	18	296	1071
05:00 PM	20	64	2	4	90	11	13	13	6	43	5	48	22	2	77	35	2	38	5	80	290
05:15 PM	19	67	3	2	91	8	10	8	1	27	4	35	23	4	66	29	5	25	7	66	250
05:30 PM	15	75	4	10	104	4	5	7	9	25	2	28	23	2	55	27	9	44	10	90	274
05:45 PM	25	57	5	4	91	4	8	6	1	19	3	46	26	2	77	33	13	21	7	74	261
Total	79	263	14	20	376	27	36	34	17	114	14	157	94	10	275	124	29	128	29	310	1075
Grand Total	145	503	26	33	707	53	74	78	34	239	26	348	199	21	594	281	64	214	47	606	2146
Apprch %	20.5	71.1	3.7	4.7		22.2	31	32.6	14.2		4.4	58.6	33.5	3.5		46.4	10.6	35.3	7.8		
Total %	6.8	23.4	1.2	1.5	32.9	2.5	3.4	3.6	1.6	11.1	1.2	16.2	9.3	1	27.7	13.1	3	10	2.2	28.2	
Lights	145	498	26	33	702	53	69	78	34	234	25	347	184	21	577	271	63	213	47	594	2107
% Lights	100	99	100	100	99.3	100	93.2	100	100	97.9	96.2	99.7	92.5	100	97.1	96.4	98.4	99.5	100	98	98.2
Buses	0	4	0	0	4	0	5	0	0	5	0	1	14	0	15	10	1	1	0	12	36
% Buses	0	0.8	0	0	0.6	0	6.8	0	0	2.1	0	0.3	7	0	2.5	3.6	1.6	0.5	0	2	1.7
Trucks	0	1	0	0	1	0	0	0	0	0	1	0	1	0	2	0	0	0	0	0	3
% Trucks	0	0.2	0	0	0.1	0	0	0	0	0	3.8	0	0.5	0	0.3	0	0	0	0	0	0.1

Start Time	CALIFORNIA ST Southbound				SHOWERS DR Westbound				CALIFORNIA ST Northbound				SHOWERS DR Eastbound				Int. Total
	Right	Thru	Left	App. Total	Right	Thru	Left	App. Total	Right	Thru	Left	App. Total	Right	Thru	Left	App. Total	
Peak Hour Analysis From 04:00 PM to 05:45 PM - Peak 1 of 1																	
Peak Hour for Entire Intersection Begins at 04:15 PM																	
04:15 PM	15	50	2	67	7	10	9	26	6	54	30	90	33	8	20	61	244
04:30 PM	18	72	3	93	10	8	16	34	4	49	24	77	30	5	22	57	261
04:45 PM	13	57	5	75	5	12	13	30	2	43	28	73	46	13	18	77	255
05:00 PM	20	64	2	86	11	13	13	37	5	48	22	75	35	2	38	75	273
Total Volume	66	243	12	321	33	43	51	127	17	194	104	315	144	28	98	270	1033
% App. Total	20.6	75.7	3.7		26	33.9	40.2		5.4	61.6	33		53.3	10.4	36.3		
PHF	.825	.844	.600	.863	.750	.827	.797	.858	.708	.898	.867	.875	.783	.538	.645	.877	.946

Traffic Data Service

San Jose, CA
 (408) 622-4787
 tdsbay@cs.com

File Name : 12PM FINAL
 Site Code : 00000012
 Start Date : 4/27/2021
 Page No : 2

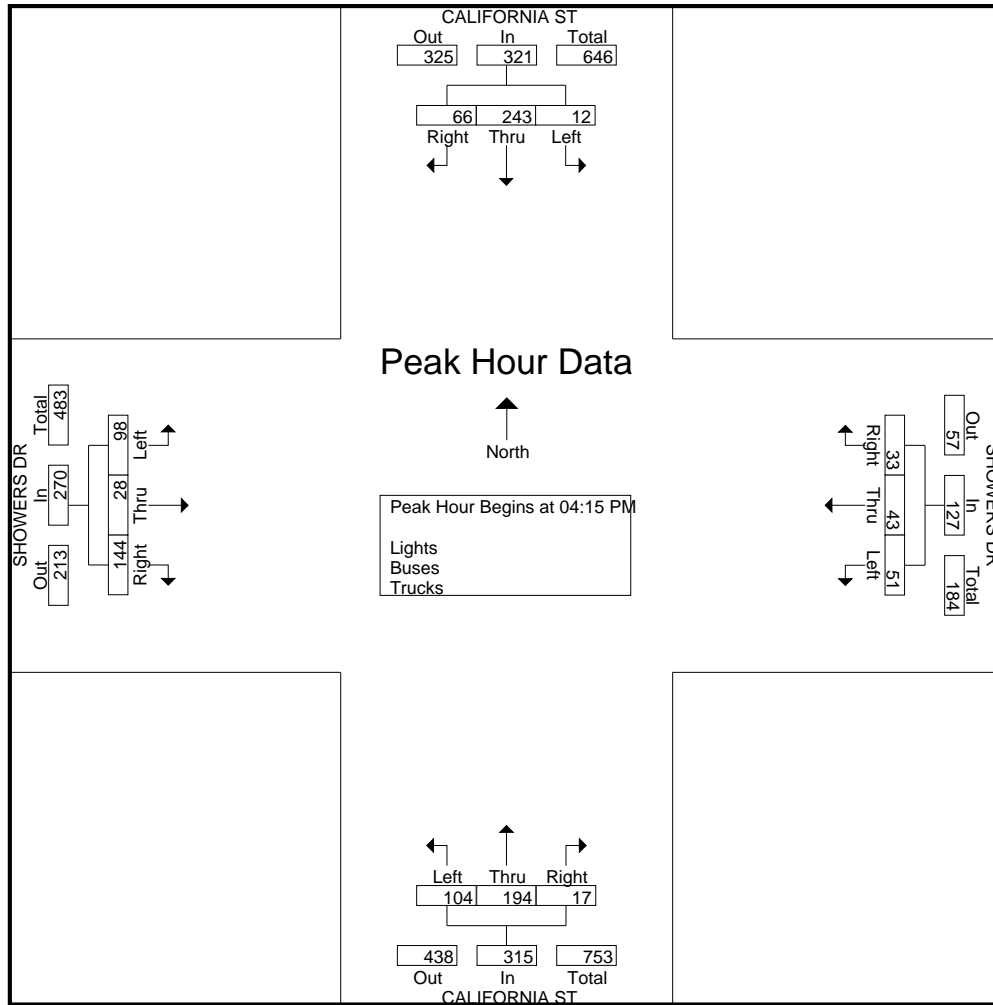

Traffic Data Service

San Jose, CA
 (408) 622-4787
 tdsbay@cs.com

File Name : 12PM FINAL
 Site Code : 00000012
 Start Date : 4/27/2021
 Page No : 1

Groups Printed- Bikes

Start Time	CALIFORNIA ST Southbound					SHOWERS DR Westbound					CALIFORNIA ST Northbound					SHOWERS DR Eastbound					Int. Total
	Right	Thru	Left	Peds	App. Total	Right	Thru	Left	Peds	App. Total	Right	Thru	Left	Peds	App. Total	Right	Thru	Left	Peds	App. Total	
04:00 PM	0	4	0	0	4	0	1	0	0	1	0	0	0	0	0	0	1	0	0	1	6
04:15 PM	0	0	0	0	0	0	0	0	0	0	0	0	0	0	0	0	0	0	0	0	0
04:30 PM	0	4	0	0	4	0	0	0	0	0	0	1	0	0	1	0	0	0	0	0	5
04:45 PM	1	4	0	0	5	0	0	0	0	0	0	2	0	0	2	1	0	0	0	1	8
Total	1	12	0	0	13	0	1	0	0	1	0	3	0	0	3	1	1	0	0	2	19
05:00 PM	0	5	0	0	5	0	0	0	0	0	2	2	0	0	4	1	0	0	0	1	10
05:15 PM	0	6	0	0	6	0	1	0	0	1	0	0	0	0	0	0	0	0	0	0	7
05:30 PM	0	4	1	0	5	0	0	1	0	1	5	0	0	0	5	0	0	0	0	0	11
05:45 PM	0	4	0	0	4	0	0	0	0	0	4	0	1	0	5	0	1	0	0	1	10
Total	0	19	1	0	20	0	1	1	0	2	11	2	1	0	14	1	1	0	0	2	38
Grand Total	1	31	1	0	33	0	2	1	0	3	11	5	1	0	17	2	2	0	0	4	57
Apprch %	3	93.9	3	0		0	66.7	33.3	0		64.7	29.4	5.9	0		50	50	0	0		
Total %	1.8	54.4	1.8	0	57.9	0	3.5	1.8	0	5.3	19.3	8.8	1.8	0	29.8	3.5	3.5	0	0	7	

Start Time	CALIFORNIA ST Southbound					SHOWERS DR Westbound					CALIFORNIA ST Northbound					SHOWERS DR Eastbound					Int. Total
	Right	Thru	Left	Peds	App. Total	Right	Thru	Left	Peds	App. Total	Right	Thru	Left	Peds	App. Total	Right	Thru	Left	Peds	App. Total	
05:00 PM	0	5	0	0	5	0	0	0	0	0	2	2	0	0	4	1	0	0	0	1	10
05:15 PM	0	6	0	0	6	0	1	0	0	1	0	0	0	0	0	0	0	0	0	0	7
05:30 PM	0	4	1	0	5	0	0	1	0	1	5	0	0	0	5	0	0	0	0	0	11
05:45 PM	0	4	0	0	4	0	0	0	0	0	4	0	1	0	5	0	1	0	0	1	10
Total Volume	0	19	1	0	20	0	1	1	0	2	11	2	1	0	14	1	1	0	0	2	38
% App. Total	0	95	5	0		0	50	50	0		78.6	14.3	7.1	0		50	50	0	0		
PHF	.000	.792	.250	.833		.000	.250	.250	.500		.550	.250	.250	.700		.250	.250	.000	.500		.864

Peak Hour Analysis From 04:00 PM to 05:45 PM - Peak 1 of 1
 Peak Hour for Entire Intersection Begins at 05:00 PM

Traffic Data Service

San Jose, CA
 (408) 622-4787
 tdsbay@cs.com

File Name : 12PM FINAL
 Site Code : 00000012
 Start Date : 4/27/2021
 Page No : 2

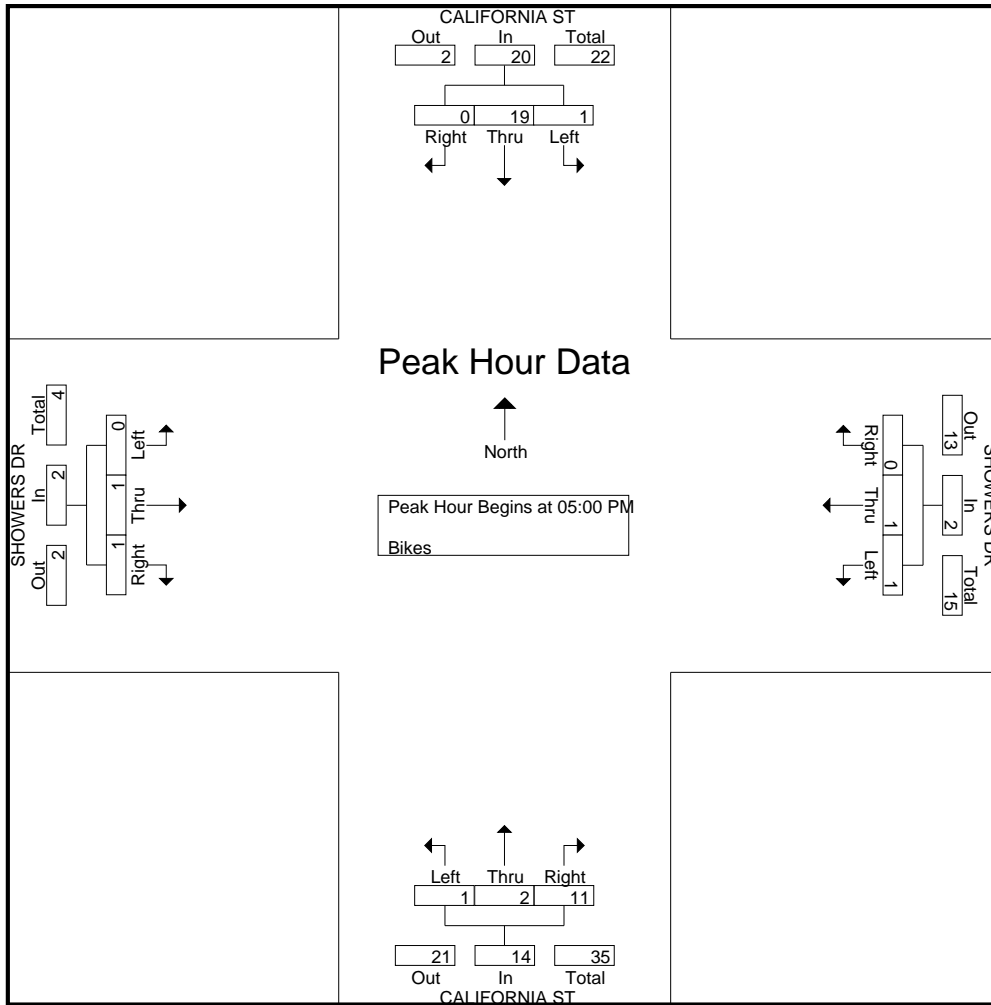

Traffic Data Service

San Jose, CA
 (408) 622-4787
 tdsbay@cs.com

File Name : 13AM FINAL
 Site Code : 00000013
 Start Date : 4/27/2021
 Page No : 1

Groups Printed- Lights - Buses - Trucks

Start Time	CALIFORNIA ST Southbound					ORTEGA AVE Westbound					CALIFORNIA ST Northbound					ORTEGA AVE Eastbound					Int. Total
	Right	Thru	Left	Peds	App. Total	Right	Thru	Left	Peds	App. Total	Right	Thru	Left	Peds	App. Total	Right	Thru	Left	Peds	App. Total	
07:00 AM	1	22	0	0	23	1	1	7	1	10	1	34	0	0	35	1	2	5	0	8	76
07:15 AM	2	19	1	1	23	1	5	8	4	18	6	38	2	2	48	5	4	5	1	15	104
07:30 AM	2	25	0	2	29	1	1	7	0	9	3	54	1	2	60	1	3	6	0	10	108
07:45 AM	4	38	1	2	45	1	4	6	5	16	0	46	5	2	53	2	1	5	4	12	126
Total	9	104	2	5	120	4	11	28	10	53	10	172	8	6	196	9	10	21	5	45	414
08:00 AM	7	31	0	2	40	3	15	17	0	35	2	43	2	0	47	6	4	5	1	16	138
08:15 AM	13	36	1	1	51	4	8	9	6	27	6	59	2	1	68	4	4	10	0	18	164
08:30 AM	4	42	1	0	47	2	3	6	3	14	10	58	2	1	71	7	19	14	3	43	175
08:45 AM	5	38	2	2	47	5	7	5	3	20	8	64	6	4	82	10	8	2	3	23	172
Total	29	147	4	5	185	14	33	37	12	96	26	224	12	6	268	27	35	31	7	100	649
Grand Total	38	251	6	10	305	18	44	65	22	149	36	396	20	12	464	36	45	52	12	145	1063
Apprch %	12.5	82.3	2	3.3		12.1	29.5	43.6	14.8		7.8	85.3	4.3	2.6		24.8	31	35.9	8.3		
Total %	3.6	23.6	0.6	0.9	28.7	1.7	4.1	6.1	2.1	14	3.4	37.3	1.9	1.1	43.7	3.4	4.2	4.9	1.1	13.6	
Lights	37	234	6	10	287	18	44	64	22	148	36	377	20	12	445	34	45	49	12	140	1020
% Lights	97.4	93.2	100	100	94.1	100	100	98.5	100	99.3	100	95.2	100	100	95.9	94.4	100	94.2	100	96.6	96
Buses	1	8	0	0	9	0	0	0	0	0	0	7	0	0	7	1	0	1	0	2	18
% Buses	2.6	3.2	0	0	3	0	0	0	0	0	0	1.8	0	0	1.5	2.8	0	1.9	0	1.4	1.7
Trucks	0	9	0	0	9	0	0	1	0	1	0	12	0	0	12	1	0	2	0	3	25
% Trucks	0	3.6	0	0	3	0	0	1.5	0	0.7	0	3	0	0	2.6	2.8	0	3.8	0	2.1	2.4

Start Time	CALIFORNIA ST Southbound				ORTEGA AVE Westbound				CALIFORNIA ST Northbound				ORTEGA AVE Eastbound				Int. Total
	Right	Thru	Left	App. Total	Right	Thru	Left	App. Total	Right	Thru	Left	App. Total	Right	Thru	Left	App. Total	
Peak Hour Analysis From 07:00 AM to 08:45 AM - Peak 1 of 1																	
Peak Hour for Entire Intersection Begins at 08:00 AM																	
08:00 AM	7	31	0	38	3	15	17	35	2	43	2	47	6	4	5	15	135
08:15 AM	13	36	1	50	4	8	9	21	6	59	2	67	4	4	10	18	156
08:30 AM	4	42	1	47	2	3	6	11	10	58	2	70	7	19	14	40	168
08:45 AM	5	38	2	45	5	7	5	17	8	64	6	78	10	8	2	20	160
Total Volume	29	147	4	180	14	33	37	84	26	224	12	262	27	35	31	93	619
% App. Total	16.1	81.7	2.2		16.7	39.3	44		9.9	85.5	4.6		29	37.6	33.3		
PHF	.558	.875	.500	.900	.700	.550	.544	.600	.650	.875	.500	.840	.675	.461	.554	.581	.921

Traffic Data Service

San Jose, CA
 (408) 622-4787
 tdsbay@cs.com

File Name : 13AM FINAL
 Site Code : 00000013
 Start Date : 4/27/2021
 Page No : 2

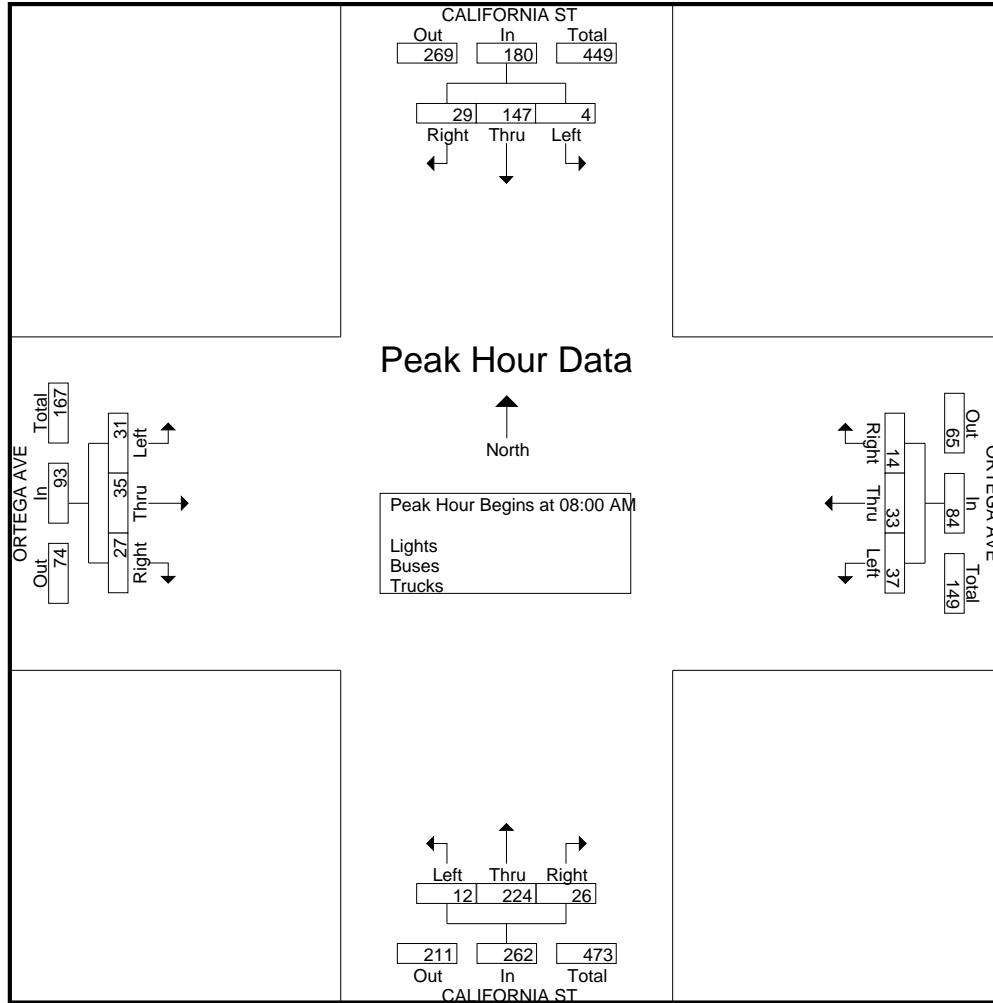

Traffic Data Service

San Jose, CA
 (408) 622-4787
 tdsbay@cs.com

File Name : 13AM FINAL
 Site Code : 00000013
 Start Date : 4/27/2021
 Page No : 1

Groups Printed- Bikes

Start Time	CALIFORNIA ST Southbound					ORTEGA AVE Westbound					CALIFORNIA ST Northbound					ORTEGA AVE Eastbound					Int. Total
	Right	Thru	Left	Peds	App. Total	Right	Thru	Left	Peds	App. Total	Right	Thru	Left	Peds	App. Total	Right	Thru	Left	Peds	App. Total	
07:00 AM	0	0	0	0	0	0	0	0	0	0	0	2	1	0	3	0	0	0	0	0	0
07:15 AM	0	0	0	0	0	0	0	0	0	0	0	1	1	0	2	0	0	1	0	1	3
07:30 AM	0	0	0	0	0	0	0	0	0	0	0	1	1	0	2	0	0	0	0	0	2
07:45 AM	0	2	0	0	2	0	0	0	0	0	0	3	1	0	4	0	0	0	0	0	6
Total	0	2	0	0	2	0	0	0	0	0	0	7	4	0	11	0	0	1	0	1	14
08:00 AM	0	1	0	0	1	0	1	0	0	1	1	3	0	0	4	0	0	0	0	0	6
08:15 AM	0	0	0	0	0	0	0	0	0	0	0	6	0	0	6	0	0	0	0	0	6
08:30 AM	0	0	0	0	0	0	0	1	0	1	0	4	1	0	5	0	0	0	0	0	6
08:45 AM	0	0	0	0	0	0	0	0	0	0	0	2	0	0	2	0	1	1	0	2	4
Total	0	1	0	0	1	0	1	1	0	2	1	15	1	0	17	0	1	1	0	2	22
Grand Total	0	3	0	0	3	0	1	1	0	2	1	22	5	0	28	0	1	2	0	3	36
Apprch %	0	100	0	0		0	50	50	0		3.6	78.6	17.9	0		0	33.3	66.7	0		
Total %	0	8.3	0	0	8.3	0	2.8	2.8	0	5.6	2.8	61.1	13.9	0	77.8	0	2.8	5.6	0	8.3	

Start Time	CALIFORNIA ST Southbound				ORTEGA AVE Westbound				CALIFORNIA ST Northbound				ORTEGA AVE Eastbound				Int. Total
	Right	Thru	Left	App. Total	Right	Thru	Left	App. Total	Right	Thru	Left	App. Total	Right	Thru	Left	App. Total	
Peak Hour Analysis From 07:00 AM to 08:45 AM - Peak 1 of 1																	
Peak Hour for Entire Intersection Begins at 07:45 AM																	
07:45 AM	0	2	0	2	0	0	0	0	0	3	1	4	0	0	0	0	6
08:00 AM	0	1	0	1	0	1	0	1	1	3	0	4	0	0	0	0	6
08:15 AM	0	0	0	0	0	0	0	0	0	6	0	6	0	0	0	0	6
08:30 AM	0	0	0	0	0	0	1	1	0	4	1	5	0	0	0	0	6
Total Volume	0	3	0	3	0	1	1	2	1	16	2	19	0	0	0	0	24
% App. Total	0	100	0		0	50	50		5.3	84.2	10.5		0	0	0		
PHF	.000	.375	.000	.375	.000	.250	.250	.500	.250	.667	.500	.792	.000	.000	.000	.000	1.00

Traffic Data Service

San Jose, CA
 (408) 622-4787
 tdsbay@cs.com

File Name : 13AM FINAL
 Site Code : 00000013
 Start Date : 4/27/2021
 Page No : 2

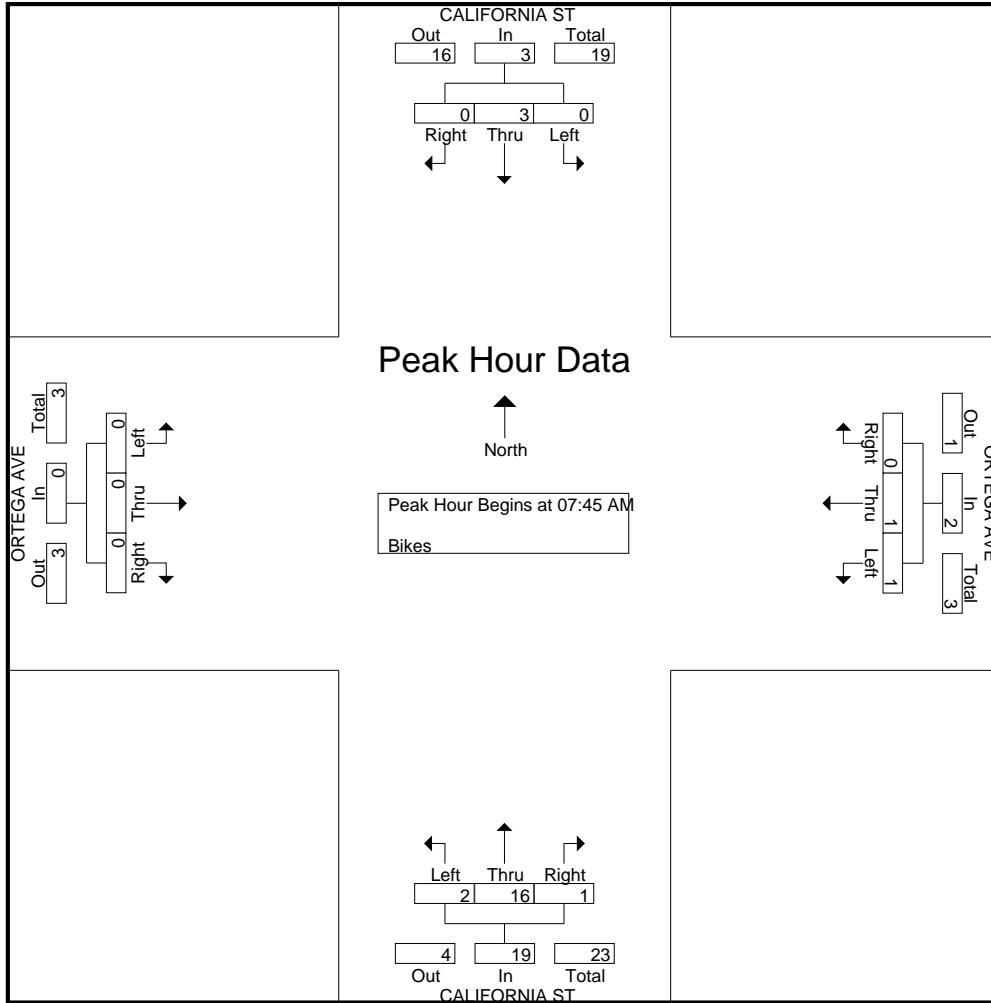

Traffic Data Service

San Jose, CA
 (408) 622-4787
 tdsbay@cs.com

File Name : 13PM FINAL
 Site Code : 00000013
 Start Date : 4/27/2021
 Page No : 1

Groups Printed- Lights - Buses - Trucks

Start Time	CALIFORNIA ST Southbound					ORTEGA AVE Westbound					CALIFORNIA ST Northbound					ORTEGA AVE Eastbound					Int. Total
	Right	Thru	Left	Peds	App. Total	Right	Thru	Left	Peds	App. Total	Right	Thru	Left	Peds	App. Total	Right	Thru	Left	Peds	App. Total	
04:00 PM	6	104	2	1	113	1	4	6	5	16	8	67	5	2	82	8	7	3	7	25	236
04:15 PM	8	96	2	5	111	3	1	4	10	18	5	90	3	7	105	2	5	7	9	23	257
04:30 PM	17	113	2	5	137	5	4	8	4	21	6	81	6	0	93	10	5	1	6	22	273
04:45 PM	9	118	2	3	132	5	6	11	2	24	9	70	1	0	80	8	4	7	3	22	258
Total	40	431	8	14	493	14	15	29	21	79	28	308	15	9	360	28	21	18	25	92	1024
05:00 PM	9	95	3	5	112	1	5	6	5	17	9	69	6	3	87	13	3	8	7	31	247
05:15 PM	7	114	1	3	125	2	3	11	5	21	9	64	7	5	85	11	4	5	11	31	262
05:30 PM	8	90	1	1	100	2	5	8	3	18	4	61	5	6	76	8	6	3	17	34	228
05:45 PM	4	92	4	7	107	6	5	12	12	35	11	73	4	3	91	8	5	6	9	28	261
Total	28	391	9	16	444	11	18	37	25	91	33	267	22	17	339	40	18	22	44	124	998
Grand Total	68	822	17	30	937	25	33	66	46	170	61	575	37	26	699	68	39	40	69	216	2022
Apprch %	7.3	87.7	1.8	3.2		14.7	19.4	38.8	27.1		8.7	82.3	5.3	3.7		31.5	18.1	18.5	31.9		
Total %	3.4	40.7	0.8	1.5	46.3	1.2	1.6	3.3	2.3	8.4	3	28.4	1.8	1.3	34.6	3.4	1.9	2	3.4	10.7	
Lights	68	806	17	30	921	24	32	66	46	168	61	559	36	26	682	58	39	40	69	206	1977
% Lights	100	98.1	100	100	98.3	96	97	100	100	98.8	100	97.2	97.3	100	97.6	85.3	100	100	100	95.4	97.8
Buses	0	13	0	0	13	0	0	0	0	0	0	16	0	0	16	9	0	0	0	9	38
% Buses	0	1.6	0	0	1.4	0	0	0	0	0	0	2.8	0	0	2.3	13.2	0	0	0	4.2	1.9
Trucks	0	3	0	0	3	1	1	0	0	2	0	0	1	0	1	1	0	0	0	1	7
% Trucks	0	0.4	0	0	0.3	4	3	0	0	1.2	0	0	2.7	0	0.1	1.5	0	0	0	0.5	0.3

Start Time	CALIFORNIA ST Southbound				ORTEGA AVE Westbound				CALIFORNIA ST Northbound				ORTEGA AVE Eastbound				Int. Total
	Right	Thru	Left	App. Total	Right	Thru	Left	App. Total	Right	Thru	Left	App. Total	Right	Thru	Left	App. Total	
Peak Hour Analysis From 04:00 PM to 05:45 PM - Peak 1 of 1																	
Peak Hour for Entire Intersection Begins at 04:30 PM																	
04:30 PM	17	113	2	132	5	4	8	17	6	81	6	93	10	5	1	16	258
04:45 PM	9	118	2	129	5	6	11	22	9	70	1	80	8	4	7	19	250
05:00 PM	9	95	3	107	1	5	6	12	9	69	6	84	13	3	8	24	227
05:15 PM	7	114	1	122	2	3	11	16	9	64	7	80	11	4	5	20	238
Total Volume	42	440	8	490	13	18	36	67	33	284	20	337	42	16	21	79	973
% App. Total	8.6	89.8	1.6		19.4	26.9	53.7		9.8	84.3	5.9		53.2	20.3	26.6		
PHF	.618	.932	.667	.928	.650	.750	.818	.761	.917	.877	.714	.906	.808	.800	.656	.823	.943

Traffic Data Service

San Jose, CA
 (408) 622-4787
 tdsbay@cs.com

File Name : 13PM FINAL
 Site Code : 00000013
 Start Date : 4/27/2021
 Page No : 2

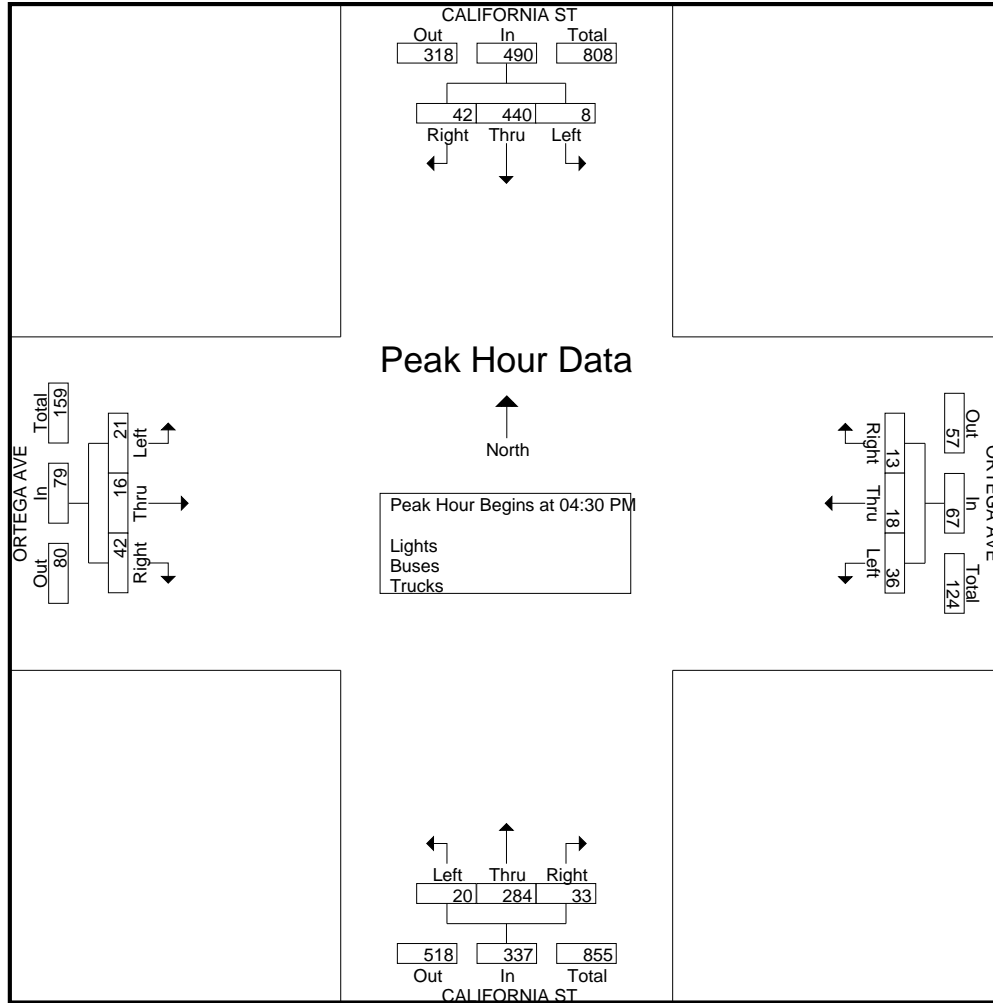

Traffic Data Service

San Jose, CA
 (408) 622-4787
 tdsbay@cs.com

File Name : 13PM FINAL
 Site Code : 00000013
 Start Date : 4/27/2021
 Page No : 1

Groups Printed- Bikes

Start Time	CALIFORNIA ST Southbound					ORTEGA AVE Westbound					CALIFORNIA ST Northbound					ORTEGA AVE Eastbound					Int. Total
	Right	Thru	Left	Peds	App. Total	Right	Thru	Left	Peds	App. Total	Right	Thru	Left	Peds	App. Total	Right	Thru	Left	Peds	App. Total	
04:00 PM	0	3	0	0	3	0	0	0	0	0	1	0	0	0	1	2	0	0	0	2	6
04:15 PM	0	1	0	0	1	0	0	0	0	0	3	0	0	0	3	1	0	0	0	1	5
04:30 PM	0	6	0	0	6	0	0	0	0	0	0	2	1	0	3	0	1	0	0	1	10
04:45 PM	1	6	0	0	7	0	0	0	0	0	1	4	0	0	5	0	1	0	0	1	13
Total	1	16	0	0	17	0	0	0	0	0	5	6	1	0	12	3	2	0	0	5	34
05:00 PM	1	4	0	0	5	0	0	0	0	0	1	4	0	0	5	0	0	0	0	0	10
05:15 PM	0	8	0	0	8	0	1	3	0	4	0	0	0	0	0	1	0	0	0	1	13
05:30 PM	0	2	0	0	2	4	0	0	0	4	0	1	0	0	1	0	1	0	0	1	8
05:45 PM	0	3	0	0	3	0	0	0	0	0	0	1	0	0	1	0	0	0	0	0	4
Total	1	17	0	0	18	4	1	3	0	8	1	6	0	0	7	1	1	0	0	2	35
Grand Total	2	33	0	0	35	4	1	3	0	8	6	12	1	0	19	4	3	0	0	7	69
Apprch %	5.7	94.3	0	0		50	12.5	37.5	0		31.6	63.2	5.3	0		57.1	42.9	0	0		
Total %	2.9	47.8	0	0	50.7	5.8	1.4	4.3	0	11.6	8.7	17.4	1.4	0	27.5	5.8	4.3	0	0	10.1	

Start Time	CALIFORNIA ST Southbound				ORTEGA AVE Westbound				CALIFORNIA ST Northbound				ORTEGA AVE Eastbound				Int. Total
	Right	Thru	Left	App. Total	Right	Thru	Left	App. Total	Right	Thru	Left	App. Total	Right	Thru	Left	App. Total	
Peak Hour Analysis From 04:00 PM to 05:45 PM - Peak 1 of 1																	
Peak Hour for Entire Intersection Begins at 04:30 PM																	
04:30 PM	0	6	0	6	0	0	0	0	0	2	1	3	0	1	0	1	10
04:45 PM	1	6	0	7	0	0	0	0	1	4	0	5	0	1	0	1	13
05:00 PM	1	4	0	5	0	0	0	0	1	4	0	5	0	0	0	0	10
05:15 PM	0	8	0	8	0	1	3	4	0	0	0	0	1	0	0	1	13
Total Volume	2	24	0	26	0	1	3	4	2	10	1	13	1	2	0	3	46
% App. Total	7.7	92.3	0		0	25	75		15.4	76.9	7.7		33.3	66.7	0		
PHF	.500	.750	.000	.813	.000	.250	.250	.250	.500	.625	.250	.650	.250	.500	.000	.750	.885

Traffic Data Service

San Jose, CA
 (408) 622-4787
 tdsbay@cs.com

File Name : 13PM FINAL
 Site Code : 00000013
 Start Date : 4/27/2021
 Page No : 2

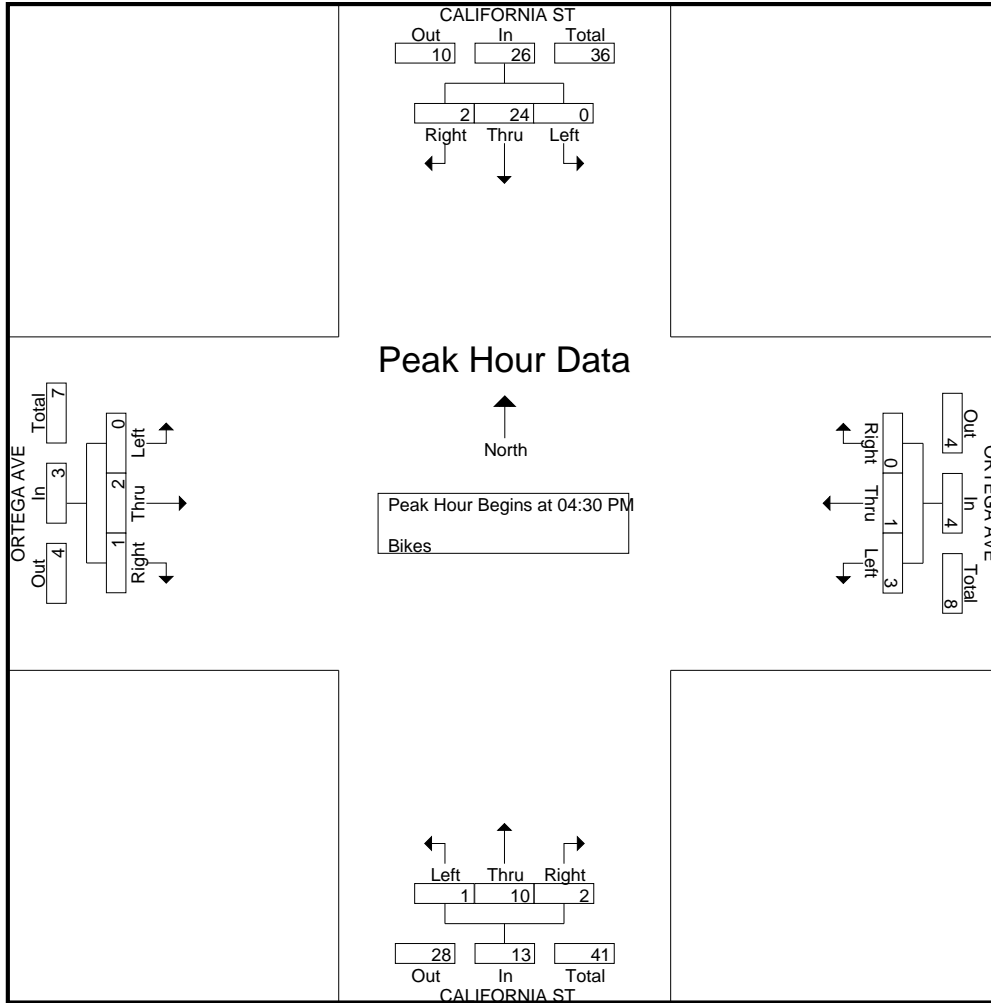

Traffic Data Service

San Jose, CA
 (408) 622-4787
 tdsbay@cs.com

File Name : 14AM FINAL
 Site Code : 00000014
 Start Date : 4/27/2021
 Page No : 1

Groups Printed- Lights - Buses - Trucks

Start Time	CALIFORNIA ST Southbound					RENGSTORFF AVE Westbound					CALIFORNIA ST Northbound					RENGSTORFF AVE Eastbound					Int. Total
	Right	Thru	Left	Peds	App. Total	Right	Thru	Left	Peds	App. Total	Right	Thru	Left	Peds	App. Total	Right	Thru	Left	Peds	App. Total	
07:00 AM	8	22	17	0	47	20	19	13	4	56	14	19	4	2	39	1	25	0	1	27	169
07:15 AM	7	26	10	0	43	20	33	16	0	69	19	18	5	2	44	9	28	4	3	44	200
07:30 AM	6	22	20	3	51	13	30	18	0	61	27	33	6	2	68	6	41	9	3	59	239
07:45 AM	16	25	20	3	64	23	41	17	4	85	17	25	7	6	55	1	44	9	2	56	260
Total	37	95	67	6	205	76	123	64	8	271	77	95	22	12	206	17	138	22	9	186	868
08:00 AM	20	36	19	3	78	22	54	15	4	95	18	29	3	6	56	3	39	4	0	46	275
08:15 AM	4	41	16	5	66	19	50	28	6	103	42	45	7	2	96	7	56	4	0	67	332
08:30 AM	6	37	19	3	65	31	54	29	3	117	25	40	5	3	73	5	56	14	3	78	333
08:45 AM	8	22	29	4	63	35	51	22	5	113	26	34	6	10	76	3	51	2	3	59	311
Total	38	136	83	15	272	107	209	94	18	428	111	148	21	21	301	18	202	24	6	250	1251
Grand Total	75	231	150	21	477	183	332	158	26	699	188	243	43	33	507	35	340	46	15	436	2119
Apprch %	15.7	48.4	31.4	4.4		26.2	47.5	22.6	3.7		37.1	47.9	8.5	6.5		8	78	10.6	3.4		
Total %	3.5	10.9	7.1	1	22.5	8.6	15.7	7.5	1.2	33	8.9	11.5	2	1.6	23.9	1.7	16	2.2	0.7	20.6	
Lights	75	224	136	21	456	171	323	155	26	675	186	236	42	33	497	35	333	45	15	428	2056
% Lights	100	97	90.7	100	95.6	93.4	97.3	98.1	100	96.6	98.9	97.1	97.7	100	98	100	97.9	97.8	100	98.2	97
Buses	0	5	5	0	10	4	2	0	0	6	1	4	0	0	5	0	0	0	0	0	21
% Buses	0	2.2	3.3	0	2.1	2.2	0.6	0	0	0.9	0.5	1.6	0	0	1	0	0	0	0	0	1
Trucks	0	2	9	0	11	8	7	3	0	18	1	3	1	0	5	0	7	1	0	8	42
% Trucks	0	0.9	6	0	2.3	4.4	2.1	1.9	0	2.6	0.5	1.2	2.3	0	1	0	2.1	2.2	0	1.8	2

Start Time	CALIFORNIA ST Southbound				RENGSTORFF AVE Westbound				CALIFORNIA ST Northbound				RENGSTORFF AVE Eastbound				Int. Total
	Right	Thru	Left	App. Total	Right	Thru	Left	App. Total	Right	Thru	Left	App. Total	Right	Thru	Left	App. Total	
Peak Hour Analysis From 07:00 AM to 08:45 AM - Peak 1 of 1																	
Peak Hour for Entire Intersection Begins at 08:00 AM																	
08:00 AM	20	36	19	75	22	54	15	91	18	29	3	50	3	39	4	46	262
08:15 AM	4	41	16	61	19	50	28	97	42	45	7	94	7	56	4	67	319
08:30 AM	6	37	19	62	31	54	29	114	25	40	5	70	5	56	14	75	321
08:45 AM	8	22	29	59	35	51	22	108	26	34	6	66	3	51	2	56	289
Total Volume	38	136	83	257	107	209	94	410	111	148	21	280	18	202	24	244	1191
% App. Total	14.8	52.9	32.3		26.1	51	22.9		39.6	52.9	7.5		7.4	82.8	9.8		
PHF	.475	.829	.716	.857	.764	.968	.810	.899	.661	.822	.750	.745	.643	.902	.429	.813	.928

Traffic Data Service

San Jose, CA
 (408) 622-4787
 tdsbay@cs.com

File Name : 14AM FINAL
 Site Code : 00000014
 Start Date : 4/27/2021
 Page No : 2

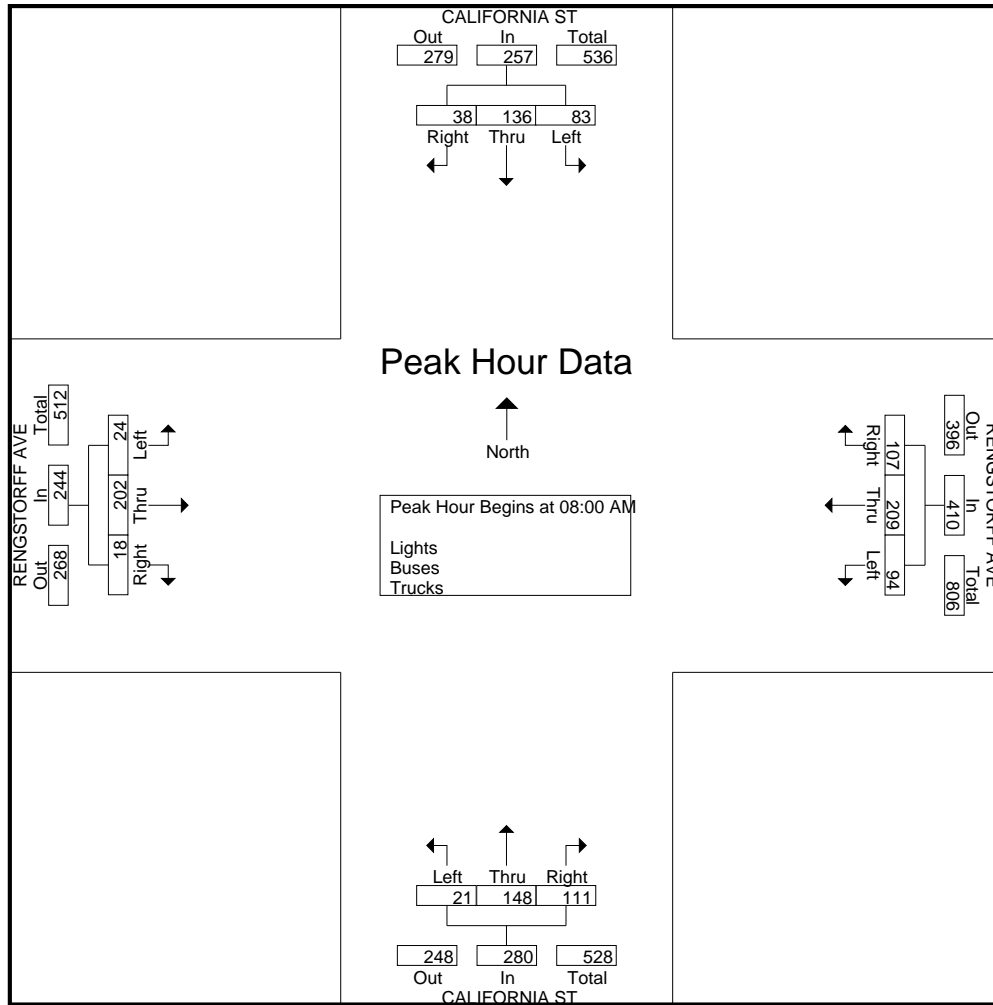

Traffic Data Service

San Jose, CA
 (408) 622-4787
 tdsbay@cs.com

File Name : 14AM FINAL
 Site Code : 00000014
 Start Date : 4/27/2021
 Page No : 1

Groups Printed- Bikes

Start Time	CALIFORNIA ST Southbound					RENGSTORFF AVE Westbound					CALIFORNIA ST Northbound					RENGSTORFF AVE Eastbound					Int. Total
	Right	Thru	Left	Peds	App. Total	Right	Thru	Left	Peds	App. Total	Right	Thru	Left	Peds	App. Total	Right	Thru	Left	Peds	App. Total	
07:00 AM	0	0	0	0	0	0	0	0	0	0	0	1	0	0	1	0	0	0	0	0	0
07:15 AM	0	0	0	0	0	0	0	0	0	0	0	1	0	0	1	0	0	0	0	0	0
07:30 AM	0	0	0	0	0	0	0	0	0	0	0	2	0	0	2	0	0	0	0	0	0
07:45 AM	0	0	1	0	1	1	0	0	0	1	0	2	1	0	3	0	2	0	0	2	7
Total	0	0	1	0	1	1	0	0	0	1	0	6	1	0	7	0	2	0	0	2	11
08:00 AM	0	0	1	0	1	2	0	0	0	2	0	0	0	0	0	0	2	1	0	3	6
08:15 AM	0	0	0	0	0	0	0	0	0	0	1	6	0	0	7	1	0	0	0	1	8
08:30 AM	1	0	0	0	1	1	0	1	0	2	1	1	0	0	2	0	0	0	0	0	5
08:45 AM	0	0	0	0	0	0	0	0	0	0	0	0	0	0	0	0	0	0	0	0	0
Total	1	0	1	0	2	3	0	1	0	4	2	7	0	0	9	1	2	1	0	4	19
Grand Total	1	0	2	0	3	4	0	1	0	5	2	13	1	0	16	1	4	1	0	6	30
Apprch %	33.3	0	66.7	0		80	0	20	0		12.5	81.2	6.2	0		16.7	66.7	16.7	0		
Total %	3.3	0	6.7	0	10	13.3	0	3.3	0	16.7	6.7	43.3	3.3	0	53.3	3.3	13.3	3.3	0	20	

Start Time	CALIFORNIA ST Southbound					RENGSTORFF AVE Westbound					CALIFORNIA ST Northbound					RENGSTORFF AVE Eastbound					Int. Total
	Right	Thru	Left	Peds	App. Total	Right	Thru	Left	Peds	App. Total	Right	Thru	Left	Peds	App. Total	Right	Thru	Left	Peds	App. Total	
Peak Hour Analysis From 07:00 AM to 08:45 AM - Peak 1 of 1																					
Peak Hour for Entire Intersection Begins at 07:45 AM																					
07:45 AM	0	0	1	0	1	1	0	0	0	1	0	2	1	0	3	0	2	0	0	2	7
08:00 AM	0	0	1	0	1	2	0	0	0	2	0	0	0	0	0	0	2	1	0	3	6
08:15 AM	0	0	0	0	0	0	0	0	0	0	1	6	0	0	7	1	0	0	0	1	8
08:30 AM	1	0	0	0	1	1	0	1	0	2	1	1	0	0	2	0	0	0	0	0	5
Total Volume	1	0	2	0	3	4	0	1	0	5	2	9	1	0	12	1	4	1	0	6	26
% App. Total	33.3	0	66.7	0		80	0	20	0		16.7	75	8.3	0		16.7	66.7	16.7	0		
PHF	.250	.000	.500	.000	.750	.500	.000	.250	.000	.625	.500	.375	.250	.000	.429	.250	.500	.250	.000	.500	.813

Traffic Data Service

San Jose, CA
 (408) 622-4787
 tdsbay@cs.com

File Name : 14AM FINAL
 Site Code : 00000014
 Start Date : 4/27/2021
 Page No : 2

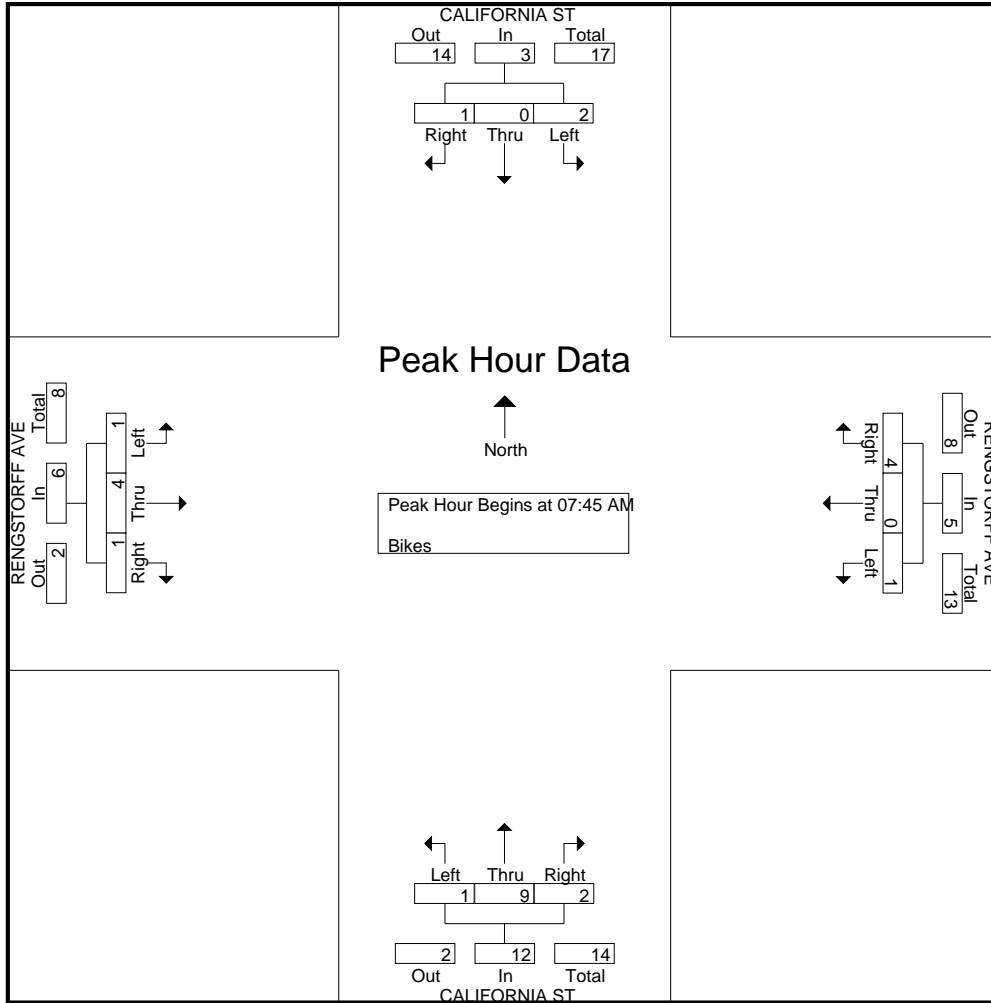

Traffic Data Service

San Jose, CA
 (408) 622-4787
 tdsbay@cs.com

File Name : 14PM FINAL
 Site Code : 00000014
 Start Date : 4/27/2021
 Page No : 1

Groups Printed- Lights - Buses - Trucks

Start Time	CALIFORNIA ST Southbound					RENGSTORFF AVE Westbound					CALIFORNIA ST Northbound					RENGSTORFF AVE Eastbound					Int. Total
	Right	Thru	Left	Peds	App. Total	Right	Thru	Left	Peds	App. Total	Right	Thru	Left	Peds	App. Total	Right	Thru	Left	Peds	App. Total	
04:00 PM	9	62	40	1	112	28	69	26	5	128	19	44	11	4	78	6	69	7	4	86	404
04:15 PM	8	73	31	9	121	40	71	26	10	147	18	55	3	3	79	6	54	12	6	78	425
04:30 PM	10	66	43	3	122	28	80	28	6	142	19	52	8	11	90	6	73	3	2	84	438
04:45 PM	11	82	60	5	158	33	66	38	5	142	15	37	6	4	62	12	74	11	2	99	461
Total	38	283	174	18	513	129	286	118	26	559	71	188	28	22	309	30	270	33	14	347	1728
05:00 PM	17	63	35	5	120	44	71	32	3	150	24	51	2	8	85	7	69	7	4	87	442
05:15 PM	13	76	44	7	140	36	84	40	4	164	23	42	8	7	80	13	76	6	3	98	482
05:30 PM	10	57	42	6	115	35	68	31	5	139	18	30	8	11	67	10	60	13	8	91	412
05:45 PM	9	66	33	4	112	44	82	30	6	162	27	54	5	12	98	8	61	8	5	82	454
Total	49	262	154	22	487	159	305	133	18	615	92	177	23	38	330	38	266	34	20	358	1790
Grand Total	87	545	328	40	1000	288	591	251	44	1174	163	365	51	60	639	68	536	67	34	705	3518
Apprch %	8.7	54.5	32.8	4		24.5	50.3	21.4	3.7		25.5	57.1	8	9.4		9.6	76	9.5	4.8		
Total %	2.5	15.5	9.3	1.1	28.4	8.2	16.8	7.1	1.3	33.4	4.6	10.4	1.4	1.7	18.2	1.9	15.2	1.9	1	20	
Lights	85	532	317	40	974	280	587	251	44	1162	163	358	51	60	632	68	529	67	34	698	3466
% Lights	97.7	97.6	96.6	100	97.4	97.2	99.3	100	100	99	100	98.1	100	100	98.9	100	98.7	100	100	99	98.5
Buses	0	12	10	0	22	8	2	0	0	10	0	7	0	7	7	0	0	0	0	0	39
% Buses	0	2.2	3	0	2.2	2.8	0.3	0	0	0.9	0	1.9	0	0	1.1	0	0	0	0	0	1.1
Trucks	2	1	1	0	4	0	2	0	0	2	0	0	0	0	0	0	7	0	0	7	13
% Trucks	2.3	0.2	0.3	0	0.4	0	0.3	0	0	0.2	0	0	0	0	0	0	1.3	0	0	1	0.4

Start Time	CALIFORNIA ST Southbound				RENGSTORFF AVE Westbound				CALIFORNIA ST Northbound				RENGSTORFF AVE Eastbound				Int. Total
	Right	Thru	Left	App. Total	Right	Thru	Left	App. Total	Right	Thru	Left	App. Total	Right	Thru	Left	App. Total	
Peak Hour Analysis From 04:00 PM to 05:45 PM - Peak 1 of 1																	
Peak Hour for Entire Intersection Begins at 04:30 PM																	
04:30 PM	10	66	43	119	28	80	28	136	19	52	8	79	6	73	3	82	416
04:45 PM	11	82	60	153	33	66	38	137	15	37	6	58	12	74	11	97	445
05:00 PM	17	63	35	115	44	71	32	147	24	51	2	77	7	69	7	83	422
05:15 PM	13	76	44	133	36	84	40	160	23	42	8	73	13	76	6	95	461
Total Volume	51	287	182	520	141	301	138	580	81	182	24	287	38	292	27	357	1744
% App. Total	9.8	55.2	35		24.3	51.9	23.8		28.2	63.4	8.4		10.6	81.8	7.6		
PHF	.750	.875	.758	.850	.801	.896	.863	.906	.844	.875	.750	.908	.731	.961	.614	.920	.946

Traffic Data Service

San Jose, CA
 (408) 622-4787
 tdsbay@cs.com

File Name : 14PM FINAL
 Site Code : 00000014
 Start Date : 4/27/2021
 Page No : 2

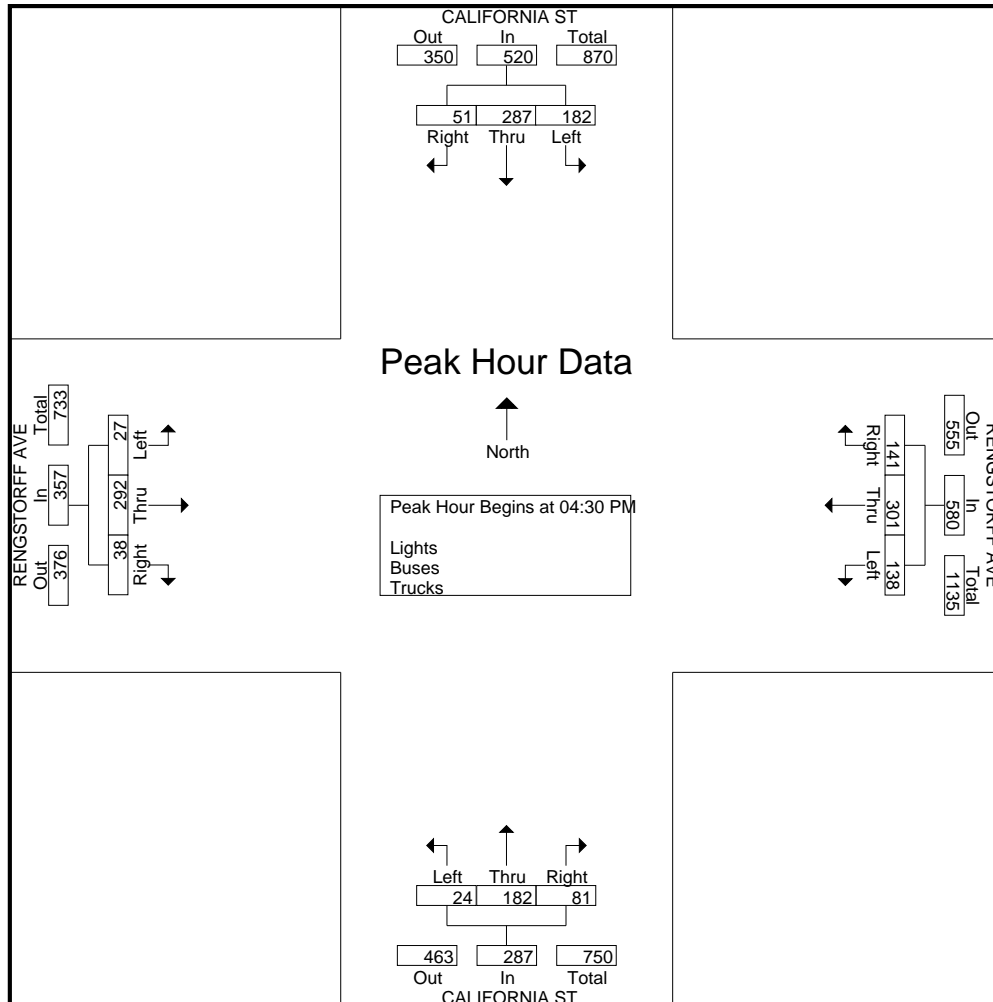

Traffic Data Service

San Jose, CA
 (408) 622-4787
 tdsbay@cs.com

File Name : 14PM FINAL
 Site Code : 00000014
 Start Date : 4/27/2021
 Page No : 1

Groups Printed- Bikes

Start Time	CALIFORNIA ST Southbound					RENGSTORFF AVE Westbound					CALIFORNIA ST Northbound					RENGSTORFF AVE Eastbound					Int. Total
	Right	Thru	Left	Peds	App. Total	Right	Thru	Left	Peds	App. Total	Right	Thru	Left	Peds	App. Total	Right	Thru	Left	Peds	App. Total	
04:00 PM	1	4	0	0	5	0	0	0	0	0	1	0	0	0	1	0	1	0	0	1	7
04:15 PM	0	2	0	0	2	0	0	1	0	1	5	2	0	0	7	0	0	0	0	0	10
04:30 PM	0	6	0	0	6	1	1	0	0	2	1	1	0	0	2	0	0	0	0	0	10
04:45 PM	1	4	1	0	6	5	0	0	0	5	0	0	0	0	0	0	1	0	0	1	12
Total	2	16	1	0	19	6	1	1	0	8	7	3	0	0	10	0	2	0	0	2	39
05:00 PM	0	4	0	0	4	1	0	0	0	1	0	3	0	0	3	0	0	0	0	0	8
05:15 PM	0	3	0	0	3	2	1	1	0	4	1	0	0	0	1	0	0	0	0	0	8
05:30 PM	1	3	3	0	7	0	2	0	0	2	1	0	0	0	1	0	1	0	0	1	11
05:45 PM	0	0	1	0	1	2	0	0	0	2	0	0	0	0	0	0	2	0	0	2	5
Total	1	10	4	0	15	5	3	1	0	9	2	3	0	0	5	0	3	0	0	3	32
Grand Total	3	26	5	0	34	11	4	2	0	17	9	6	0	0	15	0	5	0	0	5	71
Apprch %	8.8	76.5	14.7	0		64.7	23.5	11.8	0		60	40	0	0		0	100	0	0		
Total %	4.2	36.6	7	0	47.9	15.5	5.6	2.8	0	23.9	12.7	8.5	0	0	21.1	0	7	0	0	7	

Start Time	CALIFORNIA ST Southbound					RENGSTORFF AVE Westbound					CALIFORNIA ST Northbound					RENGSTORFF AVE Eastbound					Int. Total
	Right	Thru	Left	Peds	App. Total	Right	Thru	Left	Peds	App. Total	Right	Thru	Left	Peds	App. Total	Right	Thru	Left	Peds	App. Total	
Peak Hour Analysis From 04:00 PM to 05:45 PM - Peak 1 of 1																					
Peak Hour for Entire Intersection Begins at 04:15 PM																					
04:15 PM	0	2	0	0	2	0	0	1	0	1	5	2	0	0	7	0	0	0	0	0	10
04:30 PM	0	6	0	0	6	1	1	0	0	2	1	1	0	0	2	0	0	0	0	0	10
04:45 PM	1	4	1	0	6	5	0	0	0	5	0	0	0	0	0	0	1	0	0	1	12
05:00 PM	0	4	0	0	4	1	0	0	0	1	0	3	0	0	3	0	0	0	0	0	8
Total Volume	1	16	1	0	18	7	1	1	0	9	6	6	0	0	12	0	1	0	0	1	40
% App. Total	5.6	88.9	5.6	0		77.8	11.1	11.1	0		50	50	0	0		0	100	0	0		
PHF	.250	.667	.250	0	.750	.350	.250	.250	0	.450	.300	.500	.000	0	.429	.000	.250	.000	0	.250	.833

Traffic Data Service

San Jose, CA
 (408) 622-4787
 tdsbay@cs.com

File Name : 14PM FINAL
 Site Code : 00000014
 Start Date : 4/27/2021
 Page No : 2

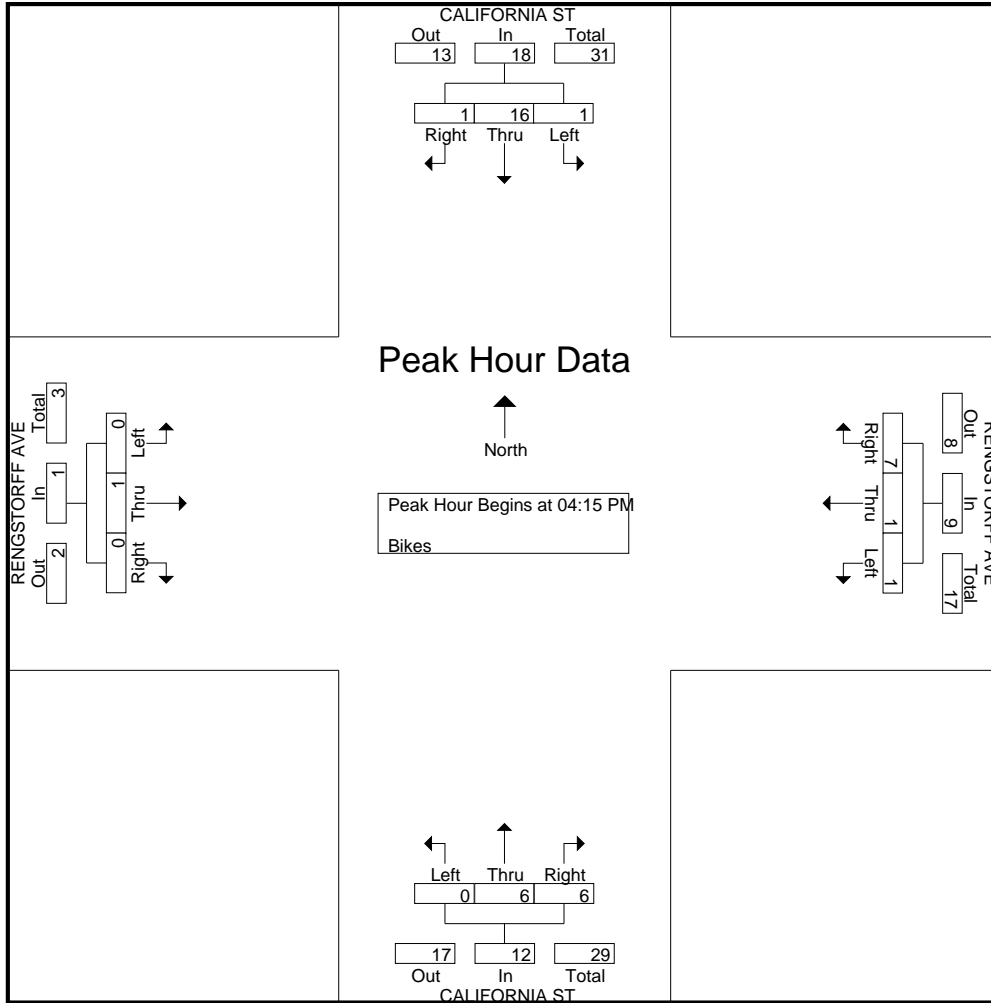

Traffic Data Service

San Jose, CA
 (408) 622-4787
 tdsbay@cs.com

File Name : 15AM FINAL
 Site Code : 00000015
 Start Date : 4/27/2021
 Page No : 1

Groups Printed- Lights - Buses - Trucks

Start Time	CENTRAL EXPY Southbound					RENGSTORFF AVE Westbound					CENTRAL EXPY Northbound					RENGSTORFF AVE Eastbound					Int. Total
	Right	Thru	Left	Peds	App. Total	Right	Thru	Left	Peds	App. Total	Right	Thru	Left	Peds	App. Total	Right	Thru	Left	Peds	App. Total	
07:00 AM	4	23	3	1	31	7	36	4	0	47	2	96	16	0	114	10	56	10	0	76	268
07:15 AM	5	21	2	1	29	10	47	0	0	57	5	137	18	3	163	8	57	16	1	82	331
07:30 AM	13	39	5	3	60	14	38	2	1	55	12	156	13	2	183	4	64	21	0	89	387
07:45 AM	5	66	15	2	88	4	57	8	0	69	30	187	27	5	249	18	72	27	0	117	523
Total	27	149	25	7	208	35	178	14	1	228	49	576	74	10	709	40	249	74	1	364	1509
08:00 AM	12	57	7	5	81	19	68	10	0	97	30	190	41	9	270	7	44	15	0	66	514
08:15 AM	19	64	7	3	93	6	40	6	2	54	19	159	39	4	221	17	102	27	0	146	514
08:30 AM	25	61	6	6	98	14	68	10	2	94	16	151	40	5	212	12	81	29	0	122	526
08:45 AM	12	69	18	3	102	10	49	5	0	64	18	158	46	12	234	11	61	22	0	94	494
Total	68	251	38	17	374	49	225	31	4	309	83	658	166	30	937	47	288	93	0	428	2048
Grand Total	95	400	63	24	582	84	403	45	5	537	132	1234	240	40	1646	87	537	167	1	792	3557
Apprch %	16.3	68.7	10.8	4.1		15.6	75	8.4	0.9		8	75	14.6	2.4		11	67.8	21.1	0.1		
Total %	2.7	11.2	1.8	0.7	16.4	2.4	11.3	1.3	0.1	15.1	3.7	34.7	6.7	1.1	46.3	2.4	15.1	4.7	0	22.3	
Lights	93	395	63	24	575	80	382	43	5	510	130	1214	237	40	1621	86	518	167	1	772	3478
% Lights	97.9	98.8	100	100	98.8	95.2	94.8	95.6	100	95	98.5	98.4	98.8	100	98.5	98.9	96.5	100	100	97.5	97.8
Buses	0	0	0	0	0	0	6	0	0	6	0	2	0	0	2	0	5	0	0	5	13
% Buses	0	0	0	0	0	0	1.5	0	0	1.1	0	0.2	0	0	0.1	0	0.9	0	0	0.6	0.4
Trucks	2	5	0	0	7	4	15	2	0	21	2	18	3	0	23	1	14	0	0	15	66
% Trucks	2.1	1.2	0	0	1.2	4.8	3.7	4.4	0	3.9	1.5	1.5	1.2	0	1.4	1.1	2.6	0	0	1.9	1.9

Start Time	CENTRAL EXPY Southbound				RENGSTORFF AVE Westbound				CENTRAL EXPY Northbound				RENGSTORFF AVE Eastbound				Int. Total
	Right	Thru	Left	App. Total	Right	Thru	Left	App. Total	Right	Thru	Left	App. Total	Right	Thru	Left	App. Total	
Peak Hour Analysis From 07:00 AM to 08:45 AM - Peak 1 of 1																	
Peak Hour for Entire Intersection Begins at 07:45 AM																	
07:45 AM	5	66	15	86	4	57	8	69	30	187	27	244	18	72	27	117	516
08:00 AM	12	57	7	76	19	68	10	97	30	190	41	261	7	44	15	66	500
08:15 AM	19	64	7	90	6	40	6	52	19	159	39	217	17	102	27	146	505
08:30 AM	25	61	6	92	14	68	10	92	16	151	40	207	12	81	29	122	513
Total Volume	61	248	35	344	43	233	34	310	95	687	147	929	54	299	98	451	2034
% App. Total	17.7	72.1	10.2		13.9	75.2	11		10.2	74	15.8		12	66.3	21.7		
PHF	.610	.939	.583	.935	.566	.857	.850	.799	.792	.904	.896	.890	.750	.733	.845	.772	.985

Traffic Data Service

San Jose, CA
 (408) 622-4787
 tdsbay@cs.com

File Name : 15AM FINAL
 Site Code : 00000015
 Start Date : 4/27/2021
 Page No : 2

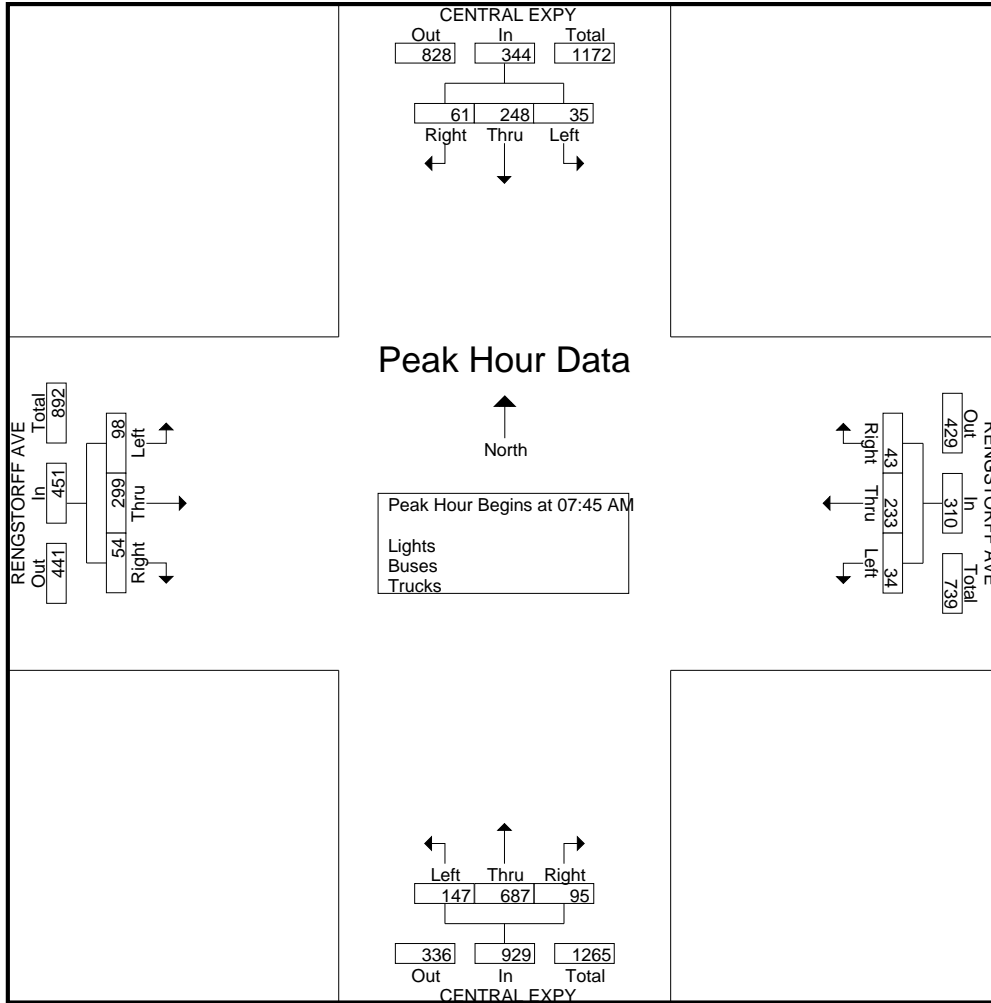

Traffic Data Service

San Jose, CA
 (408) 622-4787
 tdsbay@cs.com

File Name : 15AM FINAL
 Site Code : 00000015
 Start Date : 4/27/2021
 Page No : 1

Groups Printed- Bikes

Start Time	CENTRAL EXPY Southbound					RENGSTORFF AVE Westbound					CENTRAL EXPY Northbound					RENGSTORFF AVE Eastbound					Int. Total	
	Right	Thru	Left	Peds	App. Total	Right	Thru	Left	Peds	App. Total	Right	Thru	Left	Peds	App. Total	Right	Thru	Left	Peds	App. Total		
07:00 AM	0	0	0	0	0	0	1	0	0	1	0	0	0	0	0	0	1	0	0	0	1	2
07:15 AM	1	0	0	0	1	0	0	0	0	0	1	0	0	0	1	0	0	0	0	0	0	2
07:30 AM	0	0	0	0	0	1	0	0	0	1	0	0	0	0	0	0	0	0	0	0	0	1
07:45 AM	0	1	0	0	1	0	0	0	0	0	0	0	0	0	0	0	3	0	0	0	3	4
Total	1	1	0	0	2	1	1	0	0	2	1	0	0	0	1	0	4	0	0	4	9	
08:00 AM	0	0	0	0	0	0	1	0	0	1	1	1	0	0	2	0	0	0	0	0	0	3
08:15 AM	0	0	0	0	0	0	0	0	0	0	1	0	0	0	1	0	2	0	0	0	2	3
08:30 AM	0	0	0	0	0	0	0	0	0	0	0	0	0	0	0	0	1	0	0	0	1	1
08:45 AM	0	0	0	0	0	0	0	0	0	0	1	0	0	0	1	0	1	0	0	0	1	2
Total	0	0	0	0	0	0	1	0	0	1	3	1	0	0	4	0	4	0	0	4	9	
Grand Total	1	1	0	0	2	1	2	0	0	3	4	1	0	0	5	0	8	0	0	8	18	
Apprch %	50	50	0	0		33.3	66.7	0	0		80	20	0	0		0	100	0	0			
Total %	5.6	5.6	0	0	11.1	5.6	11.1	0	0	16.7	22.2	5.6	0	0	27.8	0	44.4	0	0	44.4		

Start Time	CENTRAL EXPY Southbound				RENGSTORFF AVE Westbound				CENTRAL EXPY Northbound				RENGSTORFF AVE Eastbound				Int. Total
	Right	Thru	Left	App. Total	Right	Thru	Left	App. Total	Right	Thru	Left	App. Total	Right	Thru	Left	App. Total	
Peak Hour Analysis From 07:00 AM to 08:45 AM - Peak 1 of 1																	
Peak Hour for Entire Intersection Begins at 07:30 AM																	
07:30 AM	0	0	0	0	1	0	0	1	0	0	0	0	0	0	0	0	1
07:45 AM	0	1	0	1	0	0	0	0	0	0	0	0	0	3	0	3	4
08:00 AM	0	0	0	0	0	1	0	1	1	1	0	2	0	0	0	0	3
08:15 AM	0	0	0	0	0	0	0	0	1	0	0	1	0	2	0	2	3
Total Volume	0	1	0	1	1	1	0	2	2	1	0	3	0	5	0	5	11
% App. Total	0	100	0		50	50	0		66.7	33.3	0		0	100	0		
PHF	.000	.250	.000	.250	.250	.250	.000	.500	.500	.250	.000	.375	.000	.417	.000	.417	.688

Traffic Data Service

San Jose, CA
 (408) 622-4787
 tdsbay@cs.com

File Name : 15AM FINAL
 Site Code : 00000015
 Start Date : 4/27/2021
 Page No : 2

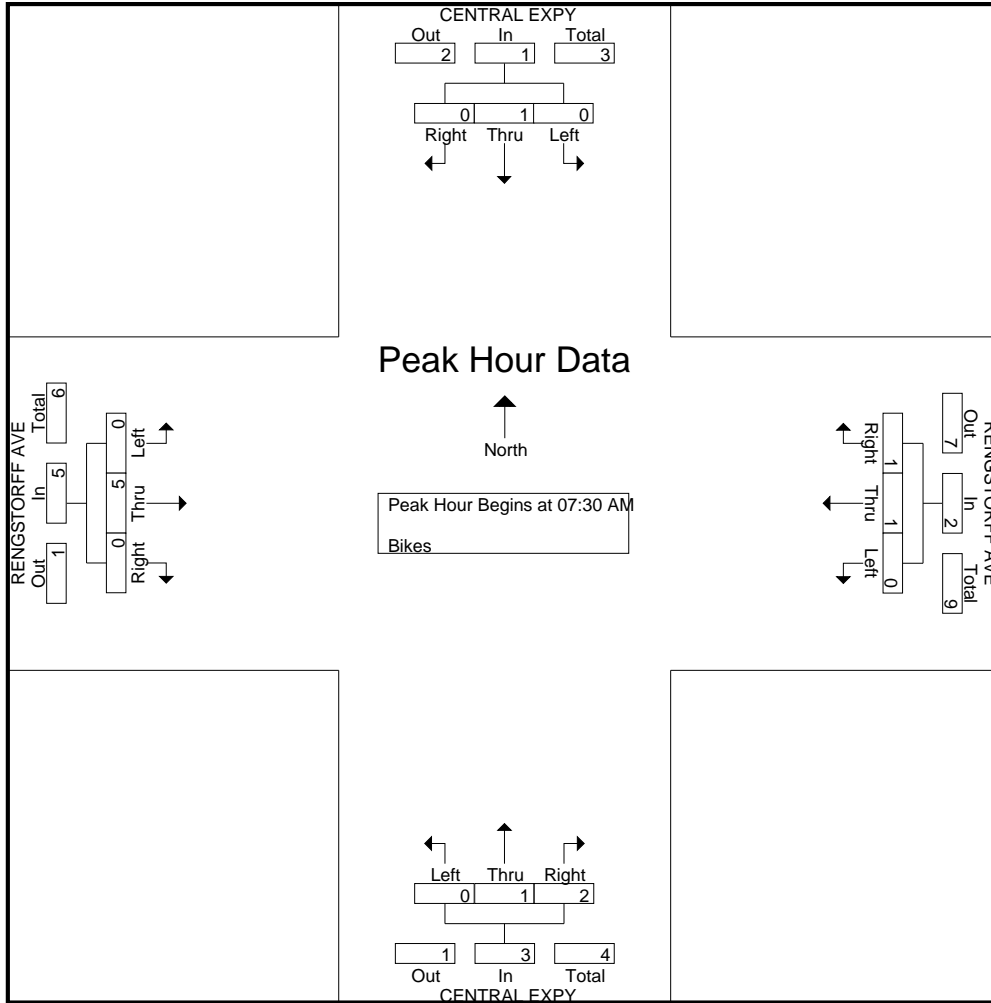

Traffic Data Service

San Jose, CA
 (408) 622-4787
 tdsbay@cs.com

File Name : 15PM FINAL
 Site Code : 00000015
 Start Date : 4/27/2021
 Page No : 1

Groups Printed- Lights - Buses - Trucks

Start Time	CENTRAL EXPY Southbound					RENGSTORFF AVE Westbound					CENTRAL EXPY Northbound					RENGSTORFF AVE Eastbound					Int. Total
	Right	Thru	Left	Peds	App. Total	Right	Thru	Left	Peds	App. Total	Right	Thru	Left	Peds	App. Total	Right	Thru	Left	Peds	App. Total	
04:00 PM	18	151	24	3	196	5	84	13	1	103	16	109	32	5	162	40	91	16	0	147	608
04:15 PM	29	182	24	1	236	8	86	20	2	116	16	66	28	3	113	33	66	10	0	109	574
04:30 PM	19	184	31	8	242	14	78	11	1	104	17	103	47	13	180	37	83	18	1	139	665
04:45 PM	34	174	18	8	234	14	92	11	1	118	31	119	37	4	191	31	91	22	0	144	687
Total	100	691	97	20	908	41	340	55	5	441	80	397	144	25	646	141	331	66	1	539	2534
05:00 PM	22	154	23	7	206	11	81	20	1	113	21	100	35	7	163	43	102	13	0	158	640
05:15 PM	23	166	23	7	219	15	112	20	1	148	26	79	43	9	157	40	98	15	0	153	677
05:30 PM	25	166	20	4	215	11	64	11	4	90	21	90	35	6	152	33	74	10	0	117	574
05:45 PM	16	137	31	10	194	9	111	14	3	137	17	78	31	9	135	33	91	22	0	146	612
Total	86	623	97	28	834	46	368	65	9	488	85	347	144	31	607	149	365	60	0	574	2503
Grand Total	186	1314	194	48	1742	87	708	120	14	929	165	744	288	56	1253	290	696	126	1	1113	5037
Apprch %	10.7	75.4	11.1	2.8		9.4	76.2	12.9	1.5		13.2	59.4	23	4.5		26.1	62.5	11.3	0.1		
Total %	3.7	26.1	3.9	1	34.6	1.7	14.1	2.4	0.3	18.4	3.3	14.8	5.7	1.1	24.9	5.8	13.8	2.5	0	22.1	
Lights	186	1308	193	48	1735	86	698	118	14	916	164	743	288	56	1251	288	681	125	1	1095	4997
% Lights	100	99.5	99.5	100	99.6	98.9	98.6	98.3	100	98.6	99.4	99.9	100	100	99.8	99.3	97.8	99.2	100	98.4	99.2
Buses	0	0	0	0	0	0	8	0	0	8	0	0	0	0	0	0	9	0	0	9	17
% Buses	0	0	0	0	0	0	1.1	0	0	0.9	0	0	0	0	0	0	1.3	0	0	0.8	0.3
Trucks	0	6	1	0	7	1	2	2	0	5	1	1	0	0	2	2	6	1	0	9	23
% Trucks	0	0.5	0.5	0	0.4	1.1	0.3	1.7	0	0.5	0.6	0.1	0	0	0.2	0.7	0.9	0.8	0	0.8	0.5

Start Time	CENTRAL EXPY Southbound				RENGSTORFF AVE Westbound				CENTRAL EXPY Northbound				RENGSTORFF AVE Eastbound				Int. Total
	Right	Thru	Left	App. Total	Right	Thru	Left	App. Total	Right	Thru	Left	App. Total	Right	Thru	Left	App. Total	
Peak Hour Analysis From 04:00 PM to 05:45 PM - Peak 1 of 1																	
Peak Hour for Entire Intersection Begins at 04:30 PM																	
04:30 PM	19	184	31	234	14	78	11	103	17	103	47	167	37	83	18	138	642
04:45 PM	34	174	18	226	14	92	11	117	31	119	37	187	31	91	22	144	674
05:00 PM	22	154	23	199	11	81	20	112	21	100	35	156	43	102	13	158	625
05:15 PM	23	166	23	212	15	112	20	147	26	79	43	148	40	98	15	153	660
Total Volume	98	678	95	871	54	363	62	479	95	401	162	658	151	374	68	593	2601
% App. Total	11.3	77.8	10.9		11.3	75.8	12.9		14.4	60.9	24.6		25.5	63.1	11.5		
PHF	.721	.921	.766	.931	.900	.810	.775	.815	.766	.842	.862	.880	.878	.917	.773	.938	.965

Traffic Data Service

San Jose, CA
 (408) 622-4787
 tdsbay@cs.com

File Name : 15PM FINAL
 Site Code : 00000015
 Start Date : 4/27/2021
 Page No : 2

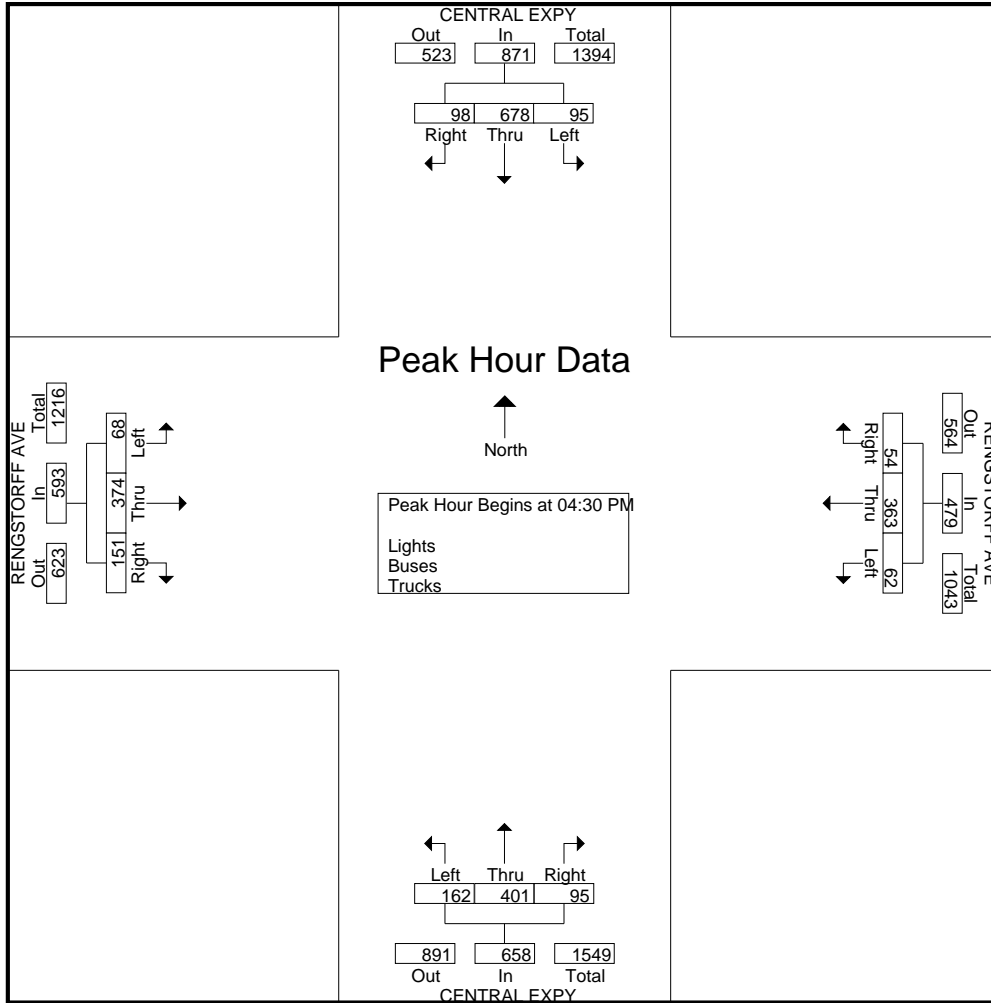

Traffic Data Service

San Jose, CA
 (408) 622-4787
 tdsbay@cs.com

File Name : 15PM FINAL
 Site Code : 00000015
 Start Date : 4/27/2021
 Page No : 1

Groups Printed- Bikes

Start Time	CENTRAL EXPY Southbound					RENGSTORFF AVE Westbound					CENTRAL EXPY Northbound					RENGSTORFF AVE Eastbound					Int. Total
	Right	Thru	Left	Peds	App. Total	Right	Thru	Left	Peds	App. Total	Right	Thru	Left	Peds	App. Total	Right	Thru	Left	Peds	App. Total	
04:00 PM	0	1	0	0	1	0	1	0	0	1	1	0	0	0	1	0	2	0	0	2	2
04:15 PM	0	1	0	0	1	0	0	0	0	0	0	0	0	0	0	1	5	0	0	6	7
04:30 PM	0	0	0	0	0	0	0	0	0	0	0	0	0	0	0	0	0	0	0	0	0
04:45 PM	0	0	0	0	0	0	0	0	0	0	0	0	0	0	0	0	3	0	0	3	3
Total	0	2	0	0	2	0	1	0	0	1	1	0	0	0	1	1	10	0	0	11	15
05:00 PM	0	0	0	0	0	0	0	0	0	0	1	0	0	0	1	0	1	0	0	1	2
05:15 PM	1	0	0	0	1	0	1	0	0	1	0	0	2	0	2	0	3	0	0	3	7
05:30 PM	1	0	0	0	1	0	0	0	0	0	0	1	0	0	1	0	6	0	0	6	8
05:45 PM	0	0	0	0	0	0	0	0	0	0	0	0	0	0	0	0	1	0	0	1	1
Total	2	0	0	0	2	0	1	0	0	1	1	1	2	0	4	0	11	0	0	11	18
Grand Total	2	2	0	0	4	0	2	0	0	2	2	1	2	0	5	1	21	0	0	22	33
Apprch %	50	50	0	0		0	100	0	0		40	20	40	0		4.5	95.5	0	0		
Total %	6.1	6.1	0	0	12.1	0	6.1	0	0	6.1	6.1	3	6.1	0	15.2	3	63.6	0	0	66.7	

Start Time	CENTRAL EXPY Southbound					RENGSTORFF AVE Westbound					CENTRAL EXPY Northbound					RENGSTORFF AVE Eastbound					Int. Total
	Right	Thru	Left	Peds	App. Total	Right	Thru	Left	Peds	App. Total	Right	Thru	Left	Peds	App. Total	Right	Thru	Left	Peds	App. Total	
04:45 PM	0	0	0	0	0	0	0	0	0	0	0	0	0	0	0	0	3	0	0	3	3
05:00 PM	0	0	0	0	0	0	0	0	0	0	1	0	0	0	1	0	1	0	0	1	2
05:15 PM	1	0	0	0	1	0	1	0	0	1	0	0	2	0	2	0	3	0	0	3	7
05:30 PM	1	0	0	0	1	0	0	0	0	0	0	1	0	0	1	0	6	0	0	6	8
Total Volume	2	0	0	0	2	0	1	0	0	1	1	1	2	0	4	0	13	0	0	13	20
% App. Total	100	0	0	0		0	100	0	0		25	25	50	0		0	100	0	0		
PHF	.500	.000	.000	.000	.500	.000	.250	.000	.000	.250	.250	.250	.250	.000	.500	.000	.542	.000	.000	.542	.625

Peak Hour Analysis From 04:00 PM to 05:45 PM - Peak 1 of 1
 Peak Hour for Entire Intersection Begins at 04:45 PM

Traffic Data Service

San Jose, CA
 (408) 622-4787
 tdsbay@cs.com

File Name : 15PM FINAL
 Site Code : 00000015
 Start Date : 4/27/2021
 Page No : 2

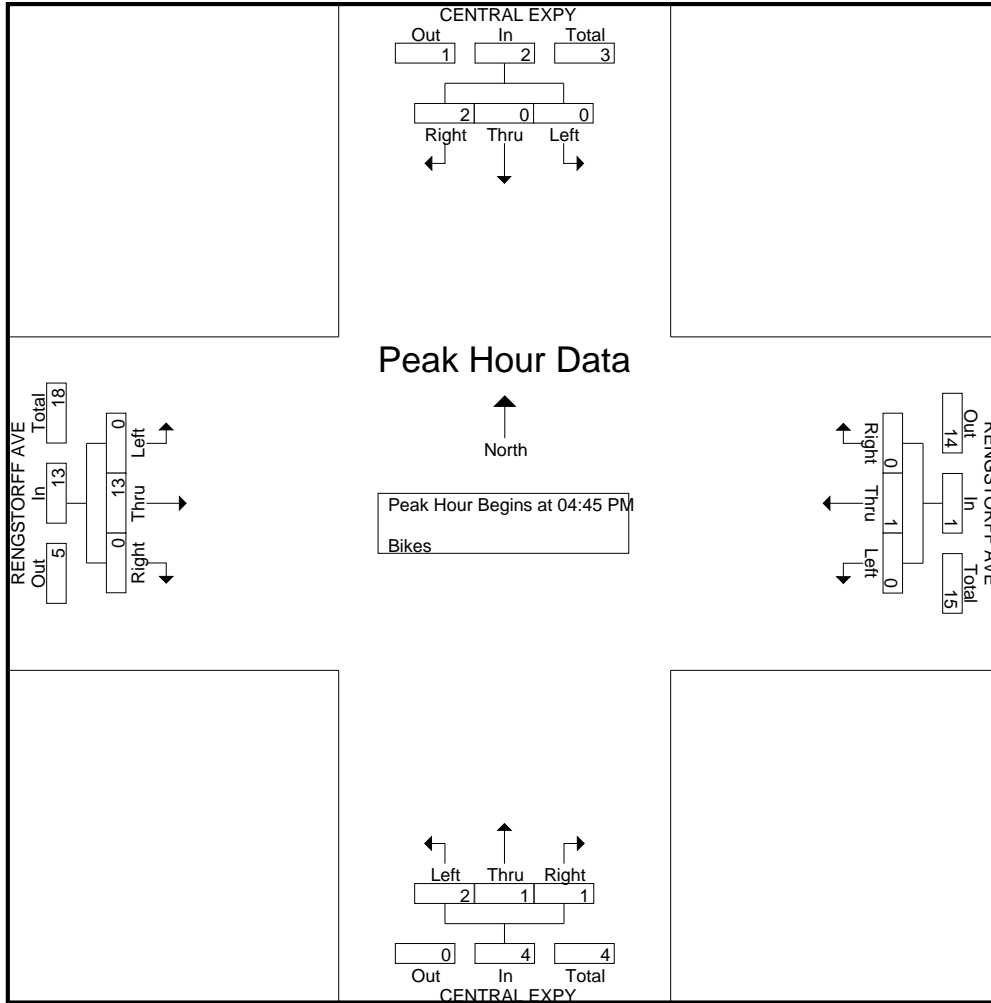

Traffic Data Service

San Jose, CA
 (408) 622-4787
 tdsbay@cs.com

File Name : 16AM FINAL
 Site Code : 00000016
 Start Date : 4/27/2021
 Page No : 1

Groups Printed- Lights - Buses - Trucks

Start Time	MIDDLEFIELD RD Southbound					SAN ANTONIO RD Westbound					MIDDLEFIELD RD Northbound					SAN ANTONIO RD Eastbound					Int. Total
	Right	Thru	Left	Peds	App. Total	Right	Thru	Left	Peds	App. Total	Right	Thru	Left	Peds	App. Total	Right	Thru	Left	Peds	App. Total	
07:00 AM	8	12	1	1	22	5	98	12	0	115	14	26	60	0	100	29	65	4	1	99	336
07:15 AM	13	9	3	1	26	8	112	8	1	129	6	49	52	0	107	27	72	8	0	107	369
07:30 AM	12	22	3	0	37	7	129	10	1	147	10	65	52	0	127	42	86	16	0	144	455
07:45 AM	21	29	6	0	56	17	124	14	1	156	19	83	81	2	185	37	92	30	1	160	557
Total	54	72	13	2	141	37	463	44	3	547	49	223	245	2	519	135	315	58	2	510	1717
08:00 AM	29	40	8	0	77	9	128	18	3	158	22	101	65	0	188	30	97	25	1	153	576
08:15 AM	46	50	8	1	105	18	151	14	1	184	15	77	59	1	152	55	121	70	3	249	690
08:30 AM	47	53	8	2	110	9	145	22	0	176	18	68	73	1	160	59	158	55	2	274	720
08:45 AM	38	58	15	0	111	8	122	10	0	140	15	63	72	0	150	66	121	51	5	243	644
Total	160	201	39	3	403	44	546	64	4	658	70	309	269	2	650	210	497	201	11	919	2630
Grand Total	214	273	52	5	544	81	1009	108	7	1205	119	532	514	4	1169	345	812	259	13	1429	4347
Apprch %	39.3	50.2	9.6	0.9		6.7	83.7	9	0.6		10.2	45.5	44	0.3		24.1	56.8	18.1	0.9		
Total %	4.9	6.3	1.2	0.1	12.5	1.9	23.2	2.5	0.2	27.7	2.7	12.2	11.8	0.1	26.9	7.9	18.7	6	0.3	32.9	
Lights	199	271	45	5	520	80	966	105	7	1158	115	524	476	4	1119	334	792	250	13	1389	4186
% Lights	93	99.3	86.5	100	95.6	98.8	95.7	97.2	100	96.1	96.6	98.5	92.6	100	95.7	96.8	97.5	96.5	100	97.2	96.3
Buses	5	0	1	0	6	0	2	0	0	2	1	1	0	0	2	0	0	4	0	4	14
% Buses	2.3	0	1.9	0	1.1	0	0.2	0	0	0.2	0.8	0.2	0	0	0.2	0	0	1.5	0	0.3	0.3
Trucks	10	2	6	0	18	1	41	3	0	45	3	7	38	0	48	11	20	5	0	36	147
% Trucks	4.7	0.7	11.5	0	3.3	1.2	4.1	2.8	0	3.7	2.5	1.3	7.4	0	4.1	3.2	2.5	1.9	0	2.5	3.4

Start Time	MIDDLEFIELD RD Southbound				SAN ANTONIO RD Westbound				MIDDLEFIELD RD Northbound				SAN ANTONIO RD Eastbound				Int. Total
	Right	Thru	Left	App. Total	Right	Thru	Left	App. Total	Right	Thru	Left	App. Total	Right	Thru	Left	App. Total	
Peak Hour Analysis From 07:00 AM to 08:45 AM - Peak 1 of 1																	
Peak Hour for Entire Intersection Begins at 08:00 AM																	
08:00 AM	29	40	8	77	9	128	18	155	22	101	65	188	30	97	25	152	572
08:15 AM	46	50	8	104	18	151	14	183	15	77	59	151	55	121	70	246	684
08:30 AM	47	53	8	108	9	145	22	176	18	68	73	159	59	158	55	272	715
08:45 AM	38	58	15	111	8	122	10	140	15	63	72	150	66	121	51	238	639
Total Volume	160	201	39	400	44	546	64	654	70	309	269	648	210	497	201	908	2610
% App. Total	40	50.2	9.8		6.7	83.5	9.8		10.8	47.7	41.5		23.1	54.7	22.1		
PHF	.851	.866	.650	.901	.611	.904	.727	.893	.795	.765	.921	.862	.795	.786	.718	.835	.913

Traffic Data Service

San Jose, CA
 (408) 622-4787
 tdsbay@cs.com

File Name : 16AM FINAL
 Site Code : 00000016
 Start Date : 4/27/2021
 Page No : 2

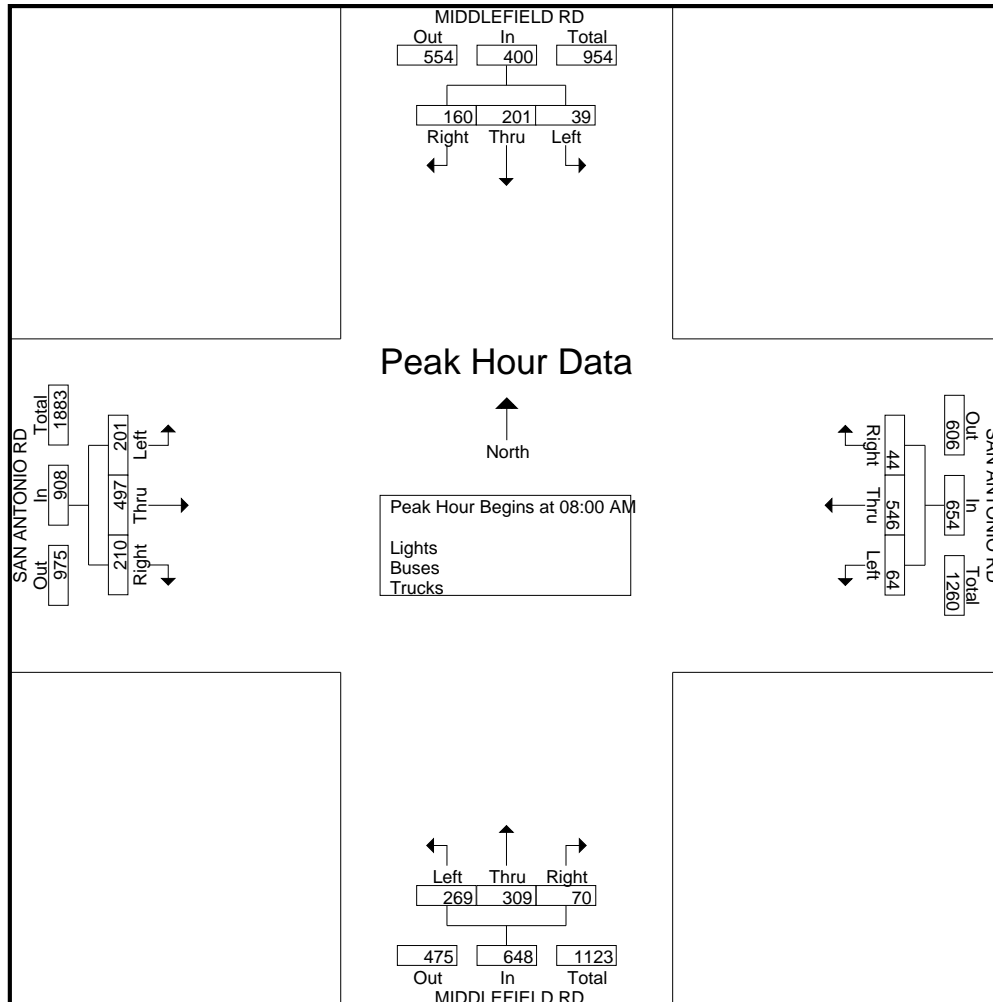

Traffic Data Service

San Jose, CA
 (408) 622-4787
 tdsbay@cs.com

File Name : 16AM FINAL
 Site Code : 00000016
 Start Date : 4/27/2021
 Page No : 1

Groups Printed- Bikes

Start Time	MIDDLEFIELD RD Southbound					SAN ANTONIO RD Westbound					MIDDLEFIELD RD Northbound					SAN ANTONIO RD Eastbound					Int. Total
	Right	Thru	Left	Peds	App. Total	Right	Thru	Left	Peds	App. Total	Right	Thru	Left	Peds	App. Total	Right	Thru	Left	Peds	App. Total	
07:00 AM	0	0	0	0	0	0	0	0	0	0	0	1	0	0	1	0	0	0	0	0	0
07:15 AM	0	0	0	0	0	0	0	0	0	0	0	0	0	0	0	0	0	1	0	1	1
07:30 AM	0	0	0	0	0	0	0	0	0	0	0	0	0	0	0	0	0	0	0	0	0
07:45 AM	0	2	0	0	2	0	0	0	0	0	0	3	0	0	3	0	0	0	0	0	5
Total	0	2	0	0	2	0	0	0	0	0	0	4	0	0	4	0	0	1	0	1	7
08:00 AM	0	0	0	0	0	0	0	0	0	0	0	5	0	0	5	0	0	0	0	0	5
08:15 AM	0	0	0	0	0	0	0	0	0	0	0	0	0	0	0	0	0	1	0	1	1
08:30 AM	0	1	0	0	1	0	0	0	0	0	0	1	0	0	1	0	0	0	0	0	2
08:45 AM	0	0	0	0	0	0	0	0	0	0	0	0	0	0	0	0	0	1	0	1	1
Total	0	1	0	0	1	0	0	0	0	0	0	6	0	0	6	0	0	2	0	2	9
Grand Total	0	3	0	0	3	0	0	0	0	0	0	10	0	0	10	0	0	3	0	3	16
Apprch %	0	100	0	0		0	0	0	0		0	100	0	0		0	0	100	0		
Total %	0	18.8	0	0	18.8	0	0	0	0	0	0	62.5	0	0	62.5	0	0	18.8	0	18.8	

Start Time	MIDDLEFIELD RD Southbound					SAN ANTONIO RD Westbound					MIDDLEFIELD RD Northbound					SAN ANTONIO RD Eastbound					Int. Total
	Right	Thru	Left	Peds	App. Total	Right	Thru	Left	Peds	App. Total	Right	Thru	Left	Peds	App. Total	Right	Thru	Left	Peds	App. Total	
Peak Hour Analysis From 07:00 AM to 08:45 AM - Peak 1 of 1																					
Peak Hour for Entire Intersection Begins at 07:45 AM																					
07:45 AM	0	2	0	0	2	0	0	0	0	0	0	3	0	0	3	0	0	0	0	0	5
08:00 AM	0	0	0	0	0	0	0	0	0	0	0	5	0	0	5	0	0	0	0	0	5
08:15 AM	0	0	0	0	0	0	0	0	0	0	0	0	0	0	0	0	0	1	0	1	1
08:30 AM	0	1	0	0	1	0	0	0	0	0	0	1	0	0	1	0	0	0	0	0	2
Total Volume	0	3	0	0	3	0	0	0	0	0	0	9	0	0	9	0	0	1	0	1	13
% App. Total	0	100	0	0		0	0	0	0		0	100	0	0		0	0	100	0		
PHF	.000	.375	.000	.000	.375	.000	.000	.000	.000	.000	.000	.450	.000	.000	.450	.000	.000	.250	.250	.250	.650

Traffic Data Service

San Jose, CA
 (408) 622-4787
 tdsbay@cs.com

File Name : 16AM FINAL
 Site Code : 00000016
 Start Date : 4/27/2021
 Page No : 2

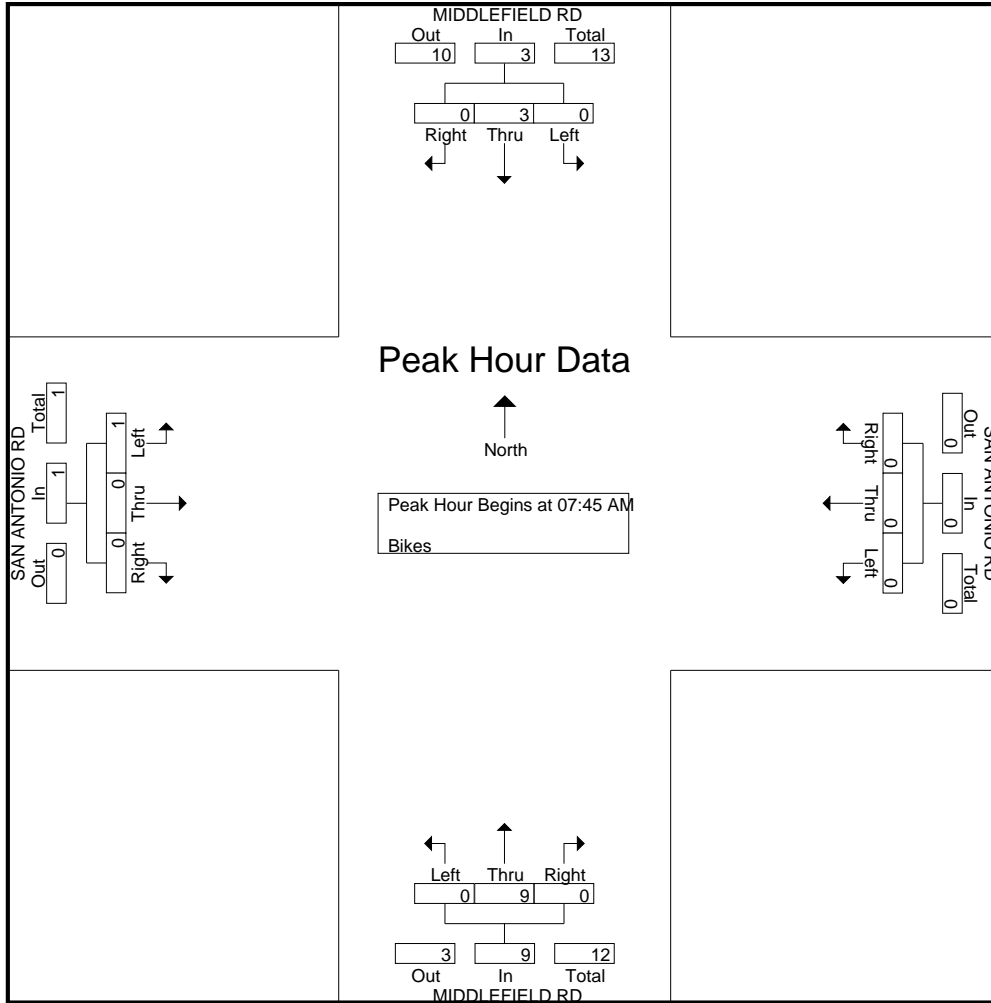

Traffic Data Service

San Jose, CA
 (408) 622-4787
 tdsbay@cs.com

File Name : 16PM FINAL
 Site Code : 00000016
 Start Date : 4/27/2021
 Page No : 1

Groups Printed- Lights - Buses - Trucks

Start Time	MIDDLEFIELD RD Southbound					SAN ANTONIO RD Westbound					MIDDLEFIELD RD Northbound					SAN ANTONIO RD Eastbound					Int. Total	
	Right	Thru	Left	Peds	App. Total	Right	Thru	Left	Peds	App. Total	Right	Thru	Left	Peds	App. Total	Right	Thru	Left	Peds	App. Total		
04:00 PM	37	54	14	1	106	17	168	25	5	215	15	56	51	4	126	53	158	39	2	252	699	
04:15 PM	36	56	18	1	111	14	181	23	0	218	12	28	46	0	86	54	134	33	4	225	640	
04:30 PM	35	62	14	0	111	15	183	35	2	235	17	43	68	0	128	62	141	25	5	233	707	
04:45 PM	40	69	8	1	118	19	184	27	0	230	13	61	43	0	117	72	131	36	1	240	705	
Total	148	241	54	3	446	65	716	110	7	898	57	188	208	4	457	241	564	133	12	950	2751	
05:00 PM	48	79	10	0	137	18	189	36	1	244	26	47	69	2	144	74	173	37	1	285	810	
05:15 PM	41	62	19	0	122	17	159	31	2	209	13	52	58	0	123	42	168	57	5	272	726	
05:30 PM	39	79	17	2	137	18	188	35	1	242	18	50	76	0	144	59	176	32	0	267	790	
05:45 PM	41	69	22	0	132	13	164	27	1	205	23	53	69	0	145	60	150	14	5	229	711	
Total	169	289	68	2	528	66	700	129	5	900	80	202	272	2	556	235	667	140	11	1053	3037	
Grand Total	317	530	122	5	974	131	1416	239	12	1798	137	390	480	6	1013	476	1231	273	23	2003	5788	
Apprch %	32.5	54.4	12.5	0.5		7.3	78.8	13.3	0.7		13.5	38.5	47.4	0.6		23.8	61.5	13.6	1.1			
Total %	5.5	9.2	2.1	0.1	16.8	2.3	24.5	4.1	0.2	31.1	2.4	6.7	8.3	0.1	17.5	8.2	21.3	4.7	0.4	34.6		
Lights	313	525	122	5	965	130	1411	238	12	1791	137	388	478	6	1009	471	1216	269	23	1979	5744	
% Lights	98.7	99.1	100	100	99.1	99.2	99.6	99.6	100	99.6	100	99.5	99.6	100	99.6	98.9	98.8	98.5	100	98.8	99.2	
Buses	4	0	0	0	4	0	1	0	0	1	0	1	1	0	2	1	2	4	0	0	7	14
% Buses	1.3	0	0	0	0.4	0	0.1	0	0	0.1	0	0.3	0.2	0	0.2	0.2	0.2	1.5	0	0.3	0.2	
Trucks	0	5	0	0	5	1	4	1	0	6	0	1	1	0	2	4	13	0	0	17	30	
% Trucks	0	0.9	0	0	0.5	0.8	0.3	0.4	0	0.3	0	0.3	0.2	0	0.2	0.8	1.1	0	0	0.8	0.5	

Start Time	MIDDLEFIELD RD Southbound				SAN ANTONIO RD Westbound				MIDDLEFIELD RD Northbound				SAN ANTONIO RD Eastbound				Int. Total
	Right	Thru	Left	App. Total	Right	Thru	Left	App. Total	Right	Thru	Left	App. Total	Right	Thru	Left	App. Total	
Peak Hour Analysis From 04:00 PM to 05:45 PM - Peak 1 of 1																	
Peak Hour for Entire Intersection Begins at 05:00 PM																	
05:00 PM	48	79	10	137	18	189	36	243	26	47	69	142	74	173	37	284	806
05:15 PM	41	62	19	122	17	159	31	207	13	52	58	123	42	168	57	267	719
05:30 PM	39	79	17	135	18	188	35	241	18	50	76	144	59	176	32	267	787
05:45 PM	41	69	22	132	13	164	27	204	23	53	69	145	60	150	14	224	705
Total Volume	169	289	68	526	66	700	129	895	80	202	272	554	235	667	140	1042	3017
% App. Total	32.1	54.9	12.9		7.4	78.2	14.4		14.4	36.5	49.1		22.6	64	13.4		
PHF	.880	.915	.773	.960	.917	.926	.896	.921	.769	.953	.895	.955	.794	.947	.614	.917	.936

Traffic Data Service

San Jose, CA
 (408) 622-4787
 tdsbay@cs.com

File Name : 16PM FINAL
 Site Code : 00000016
 Start Date : 4/27/2021
 Page No : 2

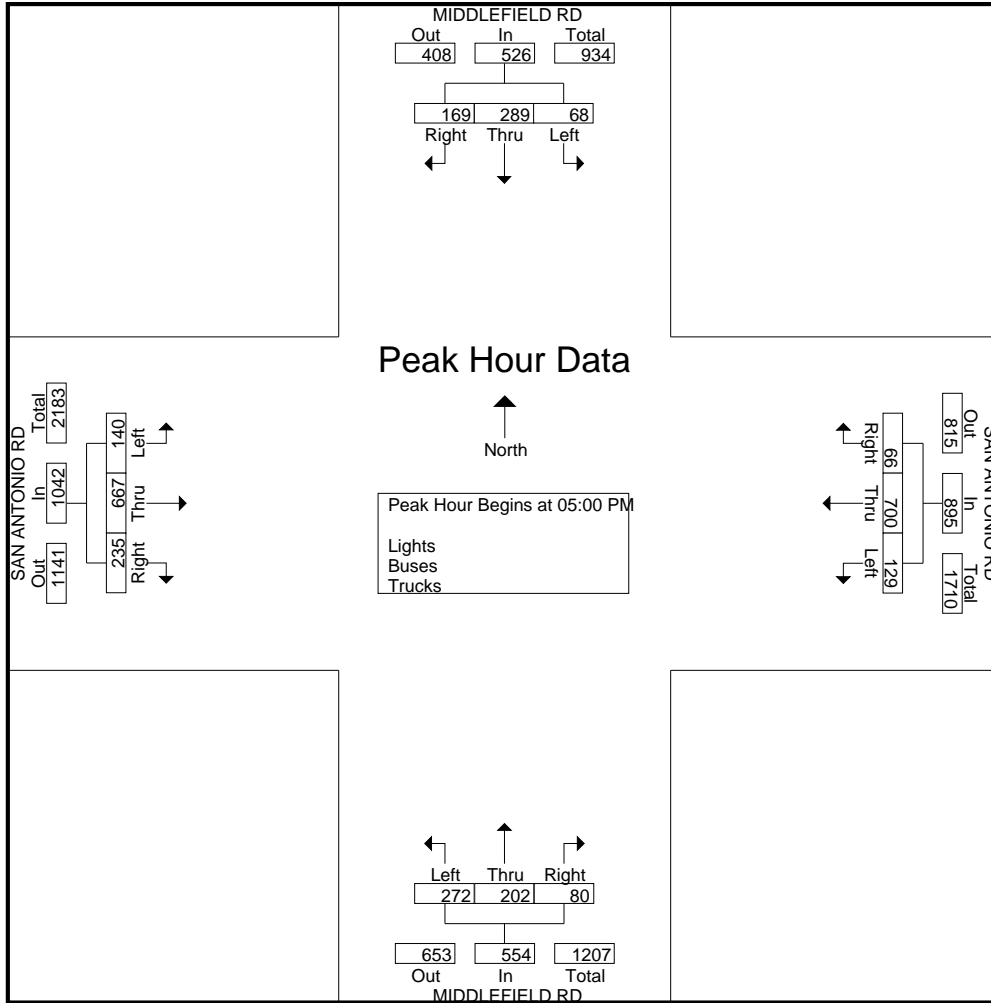

Traffic Data Service

San Jose, CA
 (408) 622-4787
 tdsbay@cs.com

File Name : 16PM FINAL
 Site Code : 00000016
 Start Date : 4/27/2021
 Page No : 1

Groups Printed- Bikes

Start Time	MIDDLEFIELD RD Southbound					SAN ANTONIO RD Westbound					MIDDLEFIELD RD Northbound					SAN ANTONIO RD Eastbound					Int. Total					
	Right	Thru	Left	Peds	App. Total	Right	Thru	Left	Peds	App. Total	Right	Thru	Left	Peds	App. Total	Right	Thru	Left	Peds	App. Total						
04:00 PM	0	1	0	0	1	0	0	0	0	0	0	1	0	0	1	0	0	0	0	0	0	0	0	0	0	2
04:15 PM	0	0	0	0	0	1	0	0	0	1	0	0	0	0	0	0	0	0	0	0	0	0	0	0	0	1
04:30 PM	2	0	0	0	2	0	1	0	0	1	0	0	0	0	0	0	0	0	0	0	0	0	0	0	0	3
04:45 PM	0	1	0	0	1	0	0	0	0	0	0	0	0	0	0	0	0	0	0	0	0	0	0	0	0	1
Total	2	2	0	0	4	1	1	0	0	2	0	1	0	0	1	0	0	0	0	0	0	0	0	0	0	7
05:00 PM	0	0	0	0	0	0	0	0	0	0	0	0	0	0	0	0	0	0	0	0	0	0	0	0	0	0
05:15 PM	0	2	0	0	2	0	0	0	0	0	0	1	0	0	1	0	0	0	0	0	0	0	0	0	0	3
05:30 PM	1	1	0	0	2	0	0	0	0	0	0	1	0	0	1	0	0	0	0	0	0	0	0	0	0	3
05:45 PM	0	2	0	0	2	0	0	0	0	0	0	2	0	0	2	0	0	0	0	0	0	0	0	0	0	4
Total	1	5	0	0	6	0	0	0	0	0	0	4	0	0	4	0	0	0	0	0	0	0	0	0	0	10
Grand Total	3	7	0	0	10	1	1	0	0	2	0	5	0	0	5	0	0	0	0	0	0	0	0	0	0	17
Apprch %	30	70	0	0		50	50	0	0		0	100	0	0		0	0	0	0		0	0	0	0		
Total %	17.6	41.2	0	0	58.8	5.9	5.9	0	0	11.8	0	29.4	0	0	29.4	0	0	0	0	0	0	0	0	0	0	

Start Time	MIDDLEFIELD RD Southbound				SAN ANTONIO RD Westbound				MIDDLEFIELD RD Northbound				SAN ANTONIO RD Eastbound				Int. Total				
	Right	Thru	Left	App. Total	Right	Thru	Left	App. Total	Right	Thru	Left	App. Total	Right	Thru	Left	App. Total					
Peak Hour Analysis From 04:00 PM to 05:45 PM - Peak 1 of 1																					
Peak Hour for Entire Intersection Begins at 05:00 PM																					
05:00 PM	0	0	0	0	0	0	0	0	0	0	0	0	0	0	0	0	0	0	0	0	0
05:15 PM	0	2	0	2	0	0	0	0	0	1	0	1	0	0	0	0	0	0	0	0	3
05:30 PM	1	1	0	2	0	0	0	0	0	1	0	1	0	0	0	0	0	0	0	0	3
05:45 PM	0	2	0	2	0	0	0	0	0	2	0	2	0	0	0	0	0	0	0	0	4
Total Volume	1	5	0	6	0	0	0	0	0	4	0	4	0	0	0	0	0	0	0	0	10
% App. Total	16.7	83.3	0		0	0	0		0	100	0		0	0	0		0	0	0		
PHF	.250	.625	.000	.750	.000	.000	.000	.000	.000	.500	.000	.500	.000	.000	.000	.000	.000	.000	.000	.000	.625

Traffic Data Service

San Jose, CA
 (408) 622-4787
 tdsbay@cs.com

File Name : 16PM FINAL
 Site Code : 00000016
 Start Date : 4/27/2021
 Page No : 2

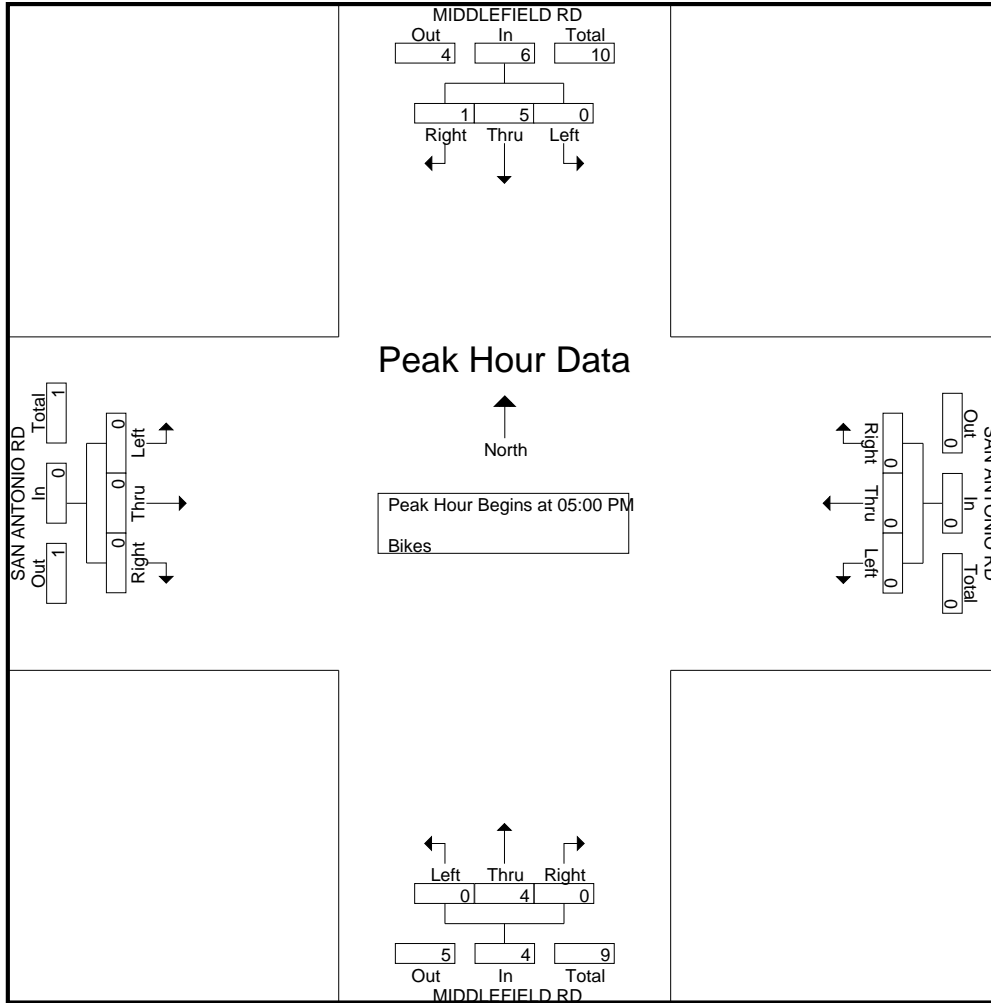

Traffic Data Service

San Jose, CA
 (408) 622-4787
 tdsbay@cs.com

File Name : 17AM FINAL
 Site Code : 00000017
 Start Date : 4/27/2021
 Page No : 1

Groups Printed- Lights - Buses - Trucks

Start Time	CHARLESTON RD Southbound						SAN ANTONIO RD Westbound						CHARLESTON RD Northbound						SAN ANTONIO RD Eastbound						SAN ANTONIO FRONTAGE Southeastbound						Int. Total
	Hard Right	Right	Thru	Left	Peds	App. Total	Right	Bear Right	Thru	Left	Peds	App. Total	Right	Thru	Bear Left	Left	Peds	App. Total	Right	Thru	Left	Hard Left	Peds	App. Total	Hard Right	Bear Right	Bear Left	Hard Left	Peds	App. Total	
07:00 AM	0	4	37	14	1	56	94	9	79	28	0	210	5	8	1	5	0	19	5	42	0	6	4	57	0	0	0	0	3	3	345
07:15 AM	0	4	39	18	1	62	107	12	111	27	0	257	6	12	2	4	0	24	6	50	3	3	0	62	0	0	0	0	0	0	405
07:30 AM	1	2	58	17	1	79	134	9	121	24	0	288	13	17	0	5	0	35	9	61	8	1	1	80	0	0	0	0	1	1	483
07:45 AM	2	4	60	36	0	102	178	12	132	33	0	355	21	24	2	5	0	52	10	61	26	5	0	102	0	0	0	0	0	0	611
Total	3	14	194	85	3	299	513	42	443	112	0	1110	45	61	5	19	0	130	30	214	37	15	5	301	0	0	0	0	4	4	1844
08:00 AM	4	4	109	30	0	147	164	9	137	40	0	350	13	21	4	4	0	42	9	90	31	0	1	131	0	0	0	0	1	1	671
08:15 AM	1	3	125	37	1	167	191	9	142	32	0	374	20	32	1	8	0	61	23	95	32	5	0	155	0	0	0	0	0	0	757
08:30 AM	1	6	113	47	1	168	183	9	151	37	1	381	16	19	2	5	1	43	14	130	29	4	1	178	0	0	0	0	1	1	771
08:45 AM	1	8	95	26	1	131	199	12	136	43	1	391	24	29	1	6	1	61	21	84	23	3	2	133	0	0	0	0	2	2	718
Total	7	21	442	140	3	613	737	39	566	152	2	1496	73	101	8	23	2	207	67	399	115	12	4	597	0	0	0	0	4	4	2917
Grand Total	10	35	636	225	6	912	1250	81	1009	264	2	2606	118	162	13	42	2	337	97	613	152	27	9	898	0	0	0	0	8	8	4761
Apprch %	1.1	3.8	69.7	24.7	0.7		48	3.1	38.7	10.1	0.1		35	48.1	3.9	12.5	0.6		10.8	68.3	16.9	3	1		0	0	0	0	100		
Total %	0.2	0.7	13.4	4.7	0.1	19.2	26.3	1.7	21.2	5.5	0	54.7	2.5	3.4	0.3	0.9	0	7.1	2	12.9	3.2	0.6	0.2	18.9	0	0	0	0	0.2	0.2	
Lights	10	30	619	213	6	878	1201	76	968	251	2	2498	110	159	11	40	2	322	90	593	148	23	9	863	0	0	0	0	8	8	4569
% Lights	100	85.7	97.3	94.7	100	96.3	96.1	93.8	95.9	95.1	100	95.9	93.2	98.1	84.6	95.2	100	95.5	92.8	96.7	97.4	85.2	100	96.1	0	0	0	0	100	100	96
Buses	0	0	1	1	0	2	4	0	2	2	0	8	0	1	0	0	0	1	0	1	1	0	0	2	0	0	0	0	0	0	13
% Buses	0	0	0.2	0.4	0	0.2	0.3	0	0.2	0.8	0	0.3	0	0.6	0	0	0	0.3	0	0.2	0.7	0	0	0.2	0	0	0	0	0	0	0.3
Trucks	0	5	16	11	0	32	45	5	39	11	0	100	8	2	2	2	0	14	7	19	3	4	0	33	0	0	0	0	0	0	179
% Trucks	0	14.3	2.5	4.9	0	3.5	3.6	6.2	3.9	4.2	0	3.8	6.8	1.2	15.4	4.8	0	4.2	7.2	3.1	2	14.8	0	3.7	0	0	0	0	0	0	3.8

Traffic Data Service

San Jose, CA
 (408) 622-4787
 tdsbay@cs.com

File Name : 17AM FINAL
 Site Code : 00000017
 Start Date : 4/27/2021
 Page No : 3

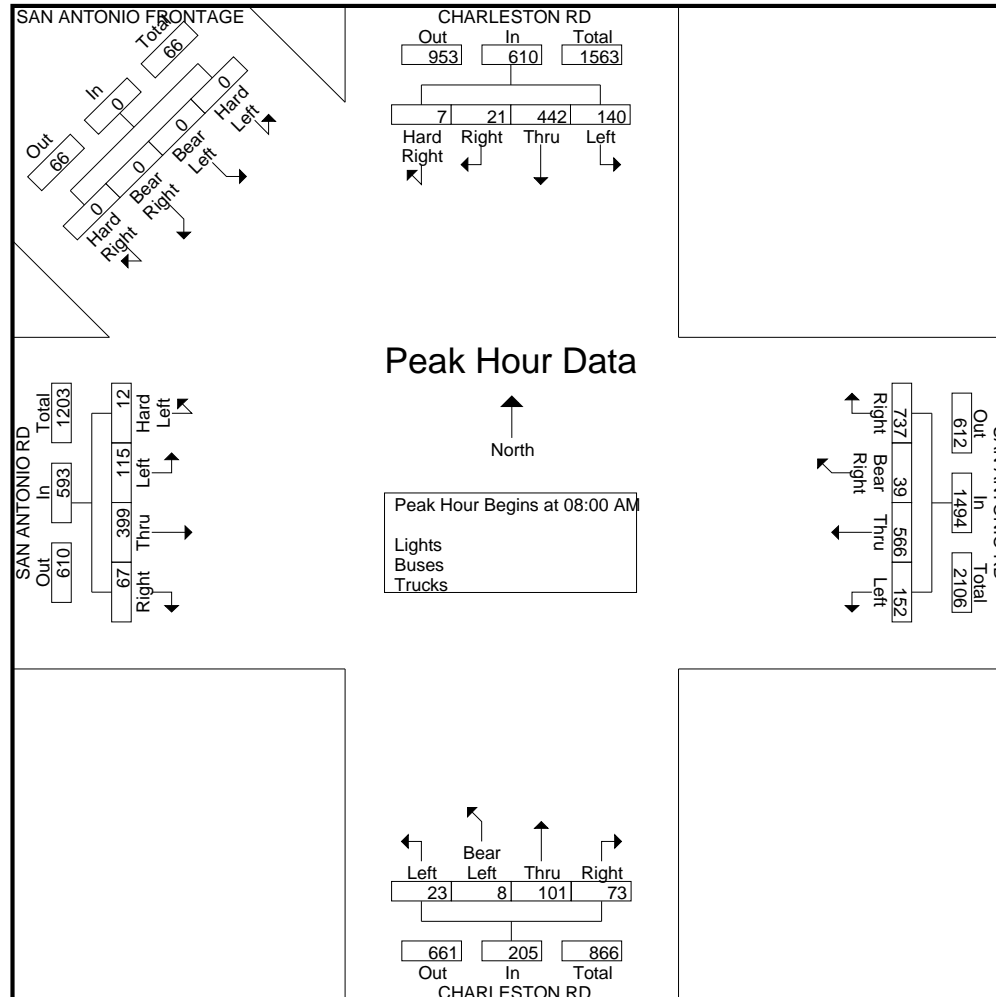

Traffic Data Service

San Jose, CA
 (408) 622-4787
 tdsbay@cs.com

File Name : 17AM FINAL
 Site Code : 00000017
 Start Date : 4/27/2021
 Page No : 2

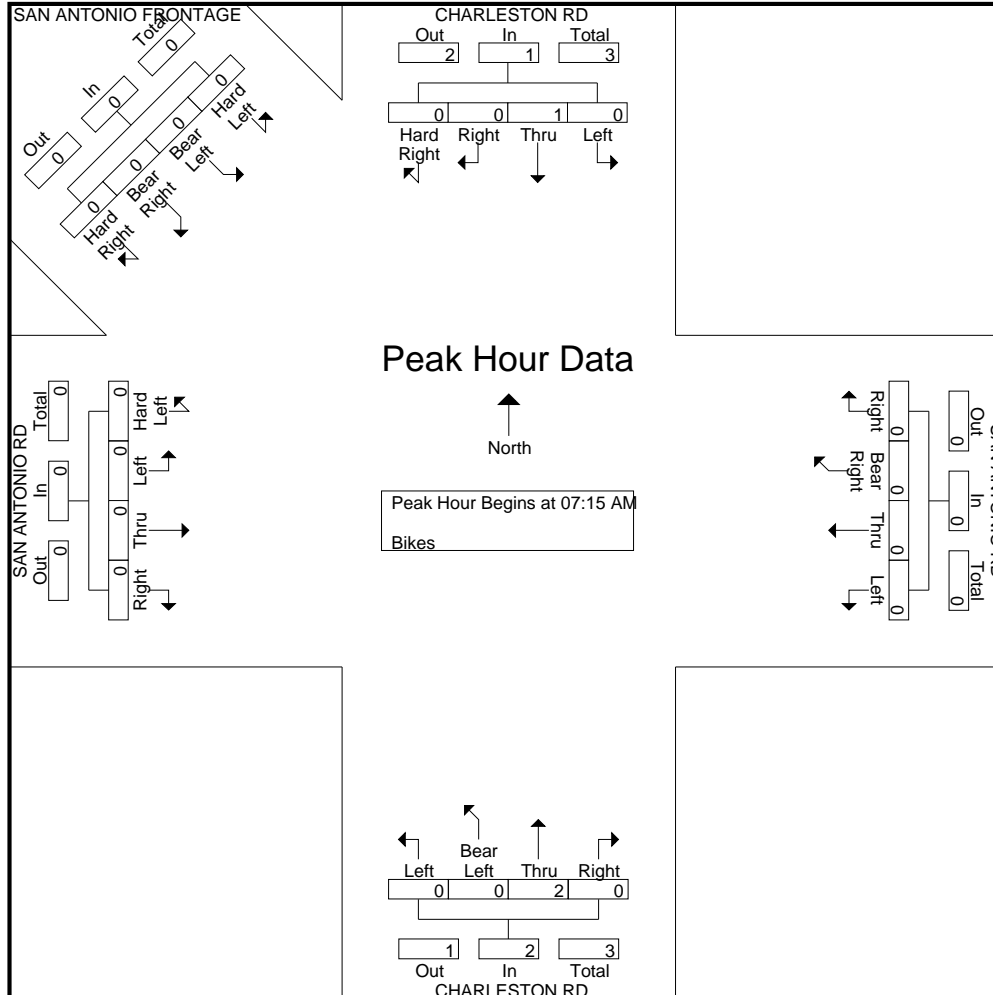

Traffic Data Service

San Jose, CA
 (408) 622-4787
 tdsbay@cs.com

File Name : 17PM FINAL
 Site Code : 00000017
 Start Date : 4/27/2021
 Page No : 3

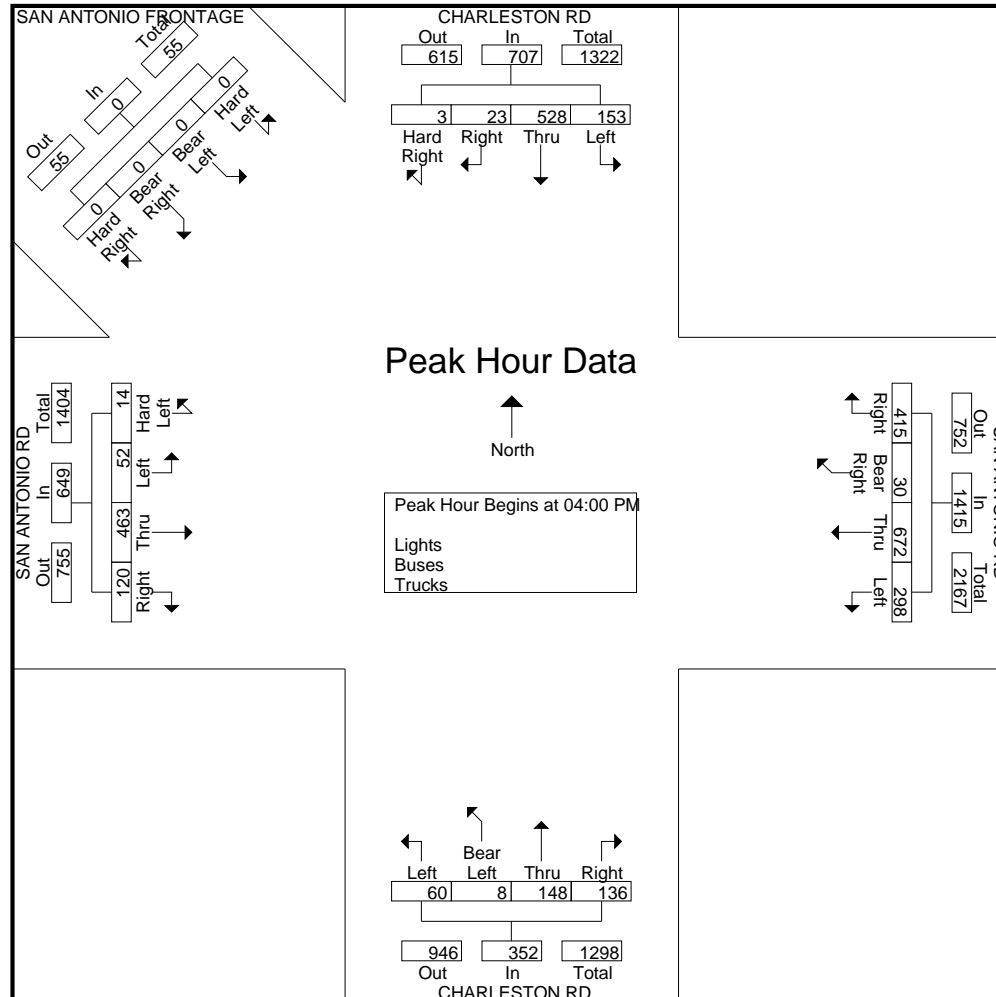

Traffic Data Service

San Jose, CA
 (408) 622-4787
 tdsbay@cs.com

File Name : 17PM FINAL
 Site Code : 00000017
 Start Date : 4/27/2021
 Page No : 2

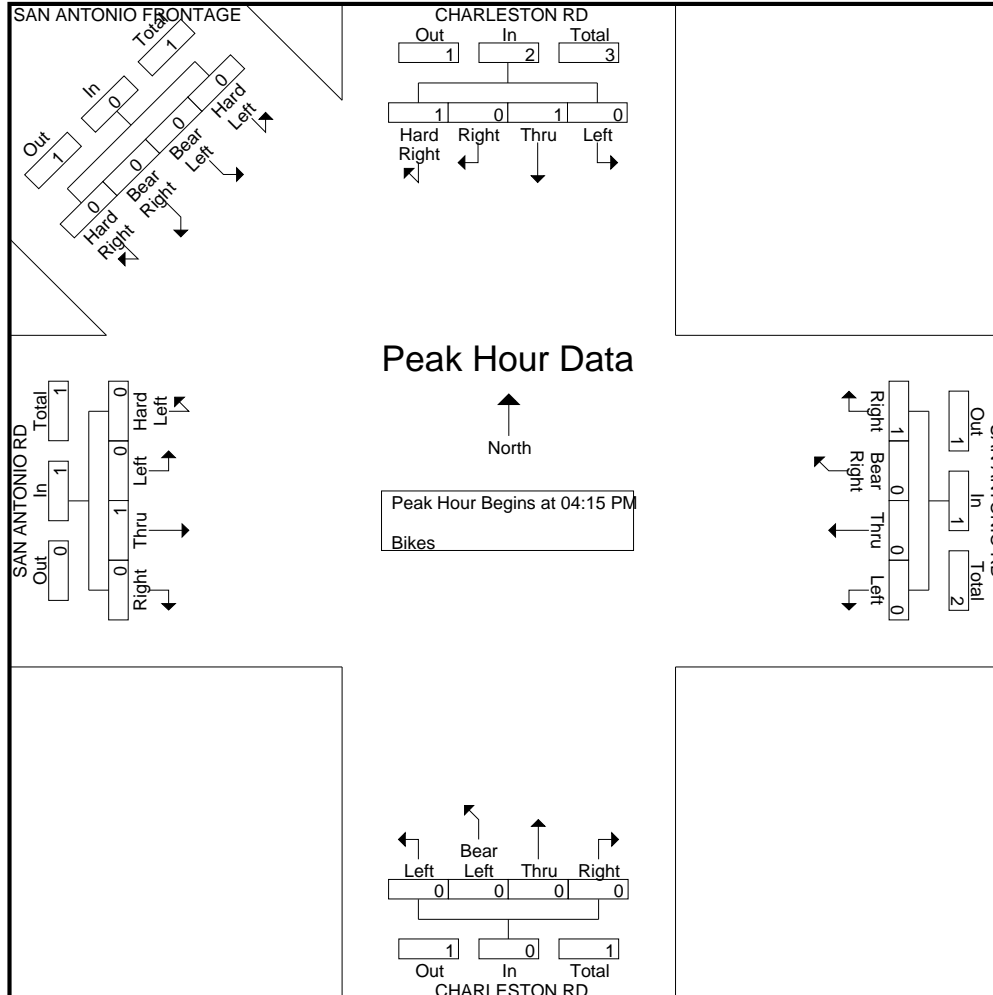

Table A-1: Previous AM Traffic Counts for Project Study Intersections #3 and #7

2645 Fayette Drive Residential Project AM Conditions

Intersection Number: 1 Trafix Node Number: 1 Intersection Name: Del Medio Avenue & Fayette Drive Peak Hour: AM Count Date: 10/29/19 Scenario: 2645-2655 Fayette Dr Residential Date of Analysis: 11/08/19													
Movements													
Scenario:	North Approach			East Approach			South Approach			West Approach			Total
	RT	TH	LT	RT	TH	LT	RT	TH	LT	RT	TH	LT	
	INDEX	7	6	5	13	12	11	4	3	2	10	9	8
	PHF	1.00	1.00	1.00	1.00	1.00	1.00	1.00	1.00	1.00	1.00	1.00	1.00
	User Adjustment	1.00	1.00	1.00	1.00	1.00	1.00	1.00	1.00	1.00	1.00	1.00	1.00
Existing Conditions	0	208	25	23	0	11	23	183	0	0	0	0	473
Project Trips	0	0	0	0	0	2	1	0	0	0	0	0	3
Existing + Project	0	208	25	23	0	13	24	183	0	0	0	0	476
Intersection Number: 2 Trafix Node Number: 2 Intersection Name: San Antonio Road & Fayette Drive Peak Hour: AM Count Date: 10/29/19 Scenario: 2645-2655 Fayette Dr Residential Date of Analysis: 11/08/19													
Movements													
Scenario:	North Approach			East Approach			South Approach			West Approach			Total
	RT	TH	LT	RT	TH	LT	RT	TH	LT	RT	TH	LT	
	INDEX	7	6	5	13	12	11	4	3	2	10	9	8
	PHF	1.00	1.00	1.00	1.00	1.00	1.00	1.00	1.00	1.00	1.00	1.00	1.00
	User Adjustment	1.00	1.00	1.00	1.00	1.00	1.00	1.00	1.00	1.00	1.00	1.00	1.00
Existing Conditions	9	827	59	49	5	44	17	1092	18	41	14	20	2195
Project Trips	1	0	0	0	0	0	0	0	2	5	0	4	12
Existing + Project	10	827	59	49	5	44	17	1092	20	46	14	24	2207
Intersection Number: 3 Trafix Node Number: 1006 Intersection Name: San Antonio Road & El Camino Real Peak Hour: AM Count Date: 11/29/19 Scenario: 2645-2655 Fayette Dr Residential Date of Analysis: 11/08/19													
Movements													
Scenario:	North Approach			East Approach			South Approach			West Approach			Total
	RT	TH	LT	RT	TH	LT	RT	TH	LT	RT	TH	LT	
	INDEX	7	6	5	13	12	11	4	3	2	10	9	8
	PHF	1.00	1.00	1.00	1.00	1.00	1.00	1.00	1.00	1.00	1.00	1.00	1.00
	User Adjustment	1.00	1.00	1.00	1.00	1.00	1.00	1.00	1.00	1.00	1.00	1.00	1.00
Existing Conditions	158	538	172	190	1349	225	43	739	188	154	717	303	4776
Project Trips	0	2	3	1	0	0	0	1	0	0	0	0	7
Existing + Project	158	540	175	191	1349	225	43	740	188	154	717	303	4783

Table A-2: Previous PM Traffic Counts for Project Study Intersections #3 and #7

2645 Fayette Drive Residential Project PM Conditions

Intersection Number: 1 Trafix Node Number: 1 Intersection Name: Del Medio Avenue & Fayette Drive Peak Hour: PM Count Date: 10/29/19 Scenario: 2645-2655 Fayette Dr Residential Date of Analysis: 11/08/19													
Movements													
Scenario:	North Approach			East Approach			South Approach			West Approach			Total
	RT	TH	LT	RT	TH	LT	RT	TH	LT	RT	TH	LT	
	INDEX	7	6	5	13	12	11	4	3	2	10	9	8
	PHF	1.00	1.00	1.00	1.00	1.00	1.00	1.00	1.00	1.00	1.00	1.00	1.00
	User Adjustment	1.00	1.00	1.00	1.00	1.00	1.00	1.00	1.00	1.00	1.00	1.00	1.00
Existing Conditions	0	153	28	37	0	22	30	174	0	0	0	0	444
Project Trips	0	0	0	0	0	1	2	0	0	0	0	0	3
Existing + Project	0	153	28	37	0	23	32	174	0	0	0	0	447
Intersection Number: 2 Trafix Node Number: 2 Intersection Name: San Antonio Road & Fayette Drive Peak Hour: PM Count Date: 10/29/19 Scenario: 2645-2655 Fayette Dr Residential Date of Analysis: 11/08/19													
Movements													
Scenario:	North Approach			East Approach			South Approach			West Approach			Total
	RT	TH	LT	RT	TH	LT	RT	TH	LT	RT	TH	LT	
	INDEX	7	6	5	13	12	11	4	3	2	10	9	8
	PHF	1.00	1.00	1.00	1.00	1.00	1.00	1.00	1.00	1.00	1.00	1.00	1.00
	User Adjustment	1.00	1.00	1.00	1.00	1.00	1.00	1.00	1.00	1.00	1.00	1.00	1.00
Existing Conditions	16	1250	158	58	28	66	77	842	43	24	21	35	2618
Project Trips	4	0	0	0	0	0	0	0	5	3	0	2	14
Existing + Project	20	1250	158	58	28	66	77	842	48	27	21	37	2632
Intersection Number: 3 Trafix Node Number: 1006 Intersection Name: San Antonio Road & El Camino Real Peak Hour: PM Count Date: 10/30/18 Scenario: 2645-2655 Fayette Dr Residential Date of Analysis: 11/08/19													
Movements													
Scenario:	North Approach			East Approach			South Approach			West Approach			Total
	RT	TH	LT	RT	TH	LT	RT	TH	LT	RT	TH	LT	
	INDEX	7	6	5	13	12	11	4	3	2	10	9	8
	PHF	1.00	1.00	1.00	1.00	1.00	1.00	1.00	1.00	1.00	1.00	1.00	1.00
	User Adjustment	1.00	1.00	1.00	1.00	1.00	1.00	1.00	1.00	1.00	1.00	1.00	1.00
Existing Conditions	176	729	305	133	873	358	94	487	210	191	1346	420	5322
Project Trips	0	1	2	3	0	0	0	2	0	0	0	0	8
Existing + Project	176	730	307	136	873	358	94	489	210	191	1346	420	5330

Appendix B: Volume Adjustment Calculations

Appendix B-1: Volume Adjustments

	Peak Hour	Intersection Number	Turning Movements											
			NBL	NBT	NBR	EBL	EBT	EBR	SBL	SBT	SBR	WBL	WBT	WBR
Growth Factor By Movement	AM	7	1.913	1.667	1.750	1.125	2.459	1.000	1.111	1.000	2.050	1.054	1.340	0.529
		3	1.131	2.565	1.759	1.741	2.155	1.132	2.313	2.220	1.901	1.284	1.466	1.736
	PM	7	1.784	2.000	1.115	1.483	1.464	1.833	1.061	1.235	1.091	1.423	2.066	0.762
		3	1.479	1.570	1.418	1.944	1.176	1.774	1.660	1.896	1.566	1.393	1.976	1.760
Weights By Movement	AM	7	0.00452	0.00059	0.0055	0.00314	0.0872	0.00334	0.00353	0.00275	0.00393	0.011	0.12117	0.00334
		3	0.02031	0.0537	0.01102	0.01102	0.03501	0.00388	0.01337	0.03297	0.00827	0.01368	0.03746	0.00929
	PM	7	0.00594	0.00225	0.00834	0.00465	0.09227	0.00674	0.0053	0.00273	0.00353	0.01781	0.09708	0.00337
		3	0.01845	0.04238	0.01021	0.00823	0.03155	0.00404	0.01928	0.05412	0.0093	0.01669	0.02813	0.00762
Weighted Growth Factors By Movement	AM	7	0.00864	0.00098	0.00962	0.00353	0.21445	0.00334	0.00393	0.00275	0.00805	0.01159	0.16241	0.00177
		3	0.02297	0.13771	0.0194	0.01919	0.07544	0.00439	0.03093	0.07319	0.01572	0.01756	0.05492	0.01613
	PM	7	0.01059	0.00449	0.00931	0.0069	0.13511	0.01236	0.00562	0.00337	0.00385	0.02535	0.20058	0.00257
		3	0.02729	0.06654	0.01448	0.01601	0.03712	0.00716	0.03201	0.10259	0.01456	0.02325	0.05556	0.01341

Growth Factors	
Total Weighted Growth Factor	1.75
AM Peak Hour Growth Factor	1.84
PM Peak Hour Growth Factor	1.66
Average Unweighted Growth Factor By Movement	1.57

Appendix B-2: Pre-COVID Traffic Counts, 2019

AM Peak Period														
DATE	TIME	IntID	NBL	NBT	NBR	EBL	EBT	EBR	SBL	SBT	SBR	WBL	WBT	WBR
10/29/2019	AM PH	7	44	5	49	18	1092	17	20	14	41	59	827	9
11/29/2019	AM PH	3	225	1349	190	188	739	43	303	717	154	172	538	158

PM Peak Period														
DATE	TIME	IntID	NBL	NBT	NBR	EBL	EBT	EBR	SBL	SBT	SBR	WBL	WBT	WBR
10/29/2019	PM PH	7	66	28	58	43	842	77	35	21	24	158	1250	16
11/29/2019	PM PH	3	358	873	190	210	487	94	420	1346	191	305	729	176

Appendix B-3: AM Traffic Counts, 2021

60 Minute Counts

DATE	TIME	INTID	NBL	NBT	NBR	EBL	EBT	EBR	SBL	SBT	SBR	WBL	WBT	WBR
4/27/2021	800	1	191	517	84	95	195	94	76	328	96	53	295	116
4/27/2021	800	2	34	633	66	0	0	0	66	414	0	32	0	101
4/27/2021	800	3	199	526	108	108	343	38	131	323	81	134	367	91
4/27/2021	800	4	29	669	99	8	6	9	116	452	44	76	10	70
4/27/2021	800	5	14	783	79	1	0	0	17	517	2	66	0	36
4/27/2021	800	6	28	856	139	0	0	0	30	578	0	195	1	99
4/27/2021	745	7	23	3	28	16	444	17	18	14	20	56	617	17
4/27/2021	745	8	0	0	0	0	512	0	0	0	15	0	679	25
4/27/2021	800	9	0	0	38	0	768	19	0	0	0	125	847	0
4/27/2021	800	10	55	33	205	27	490	37	157	37	14	185	620	79
4/27/2021	745	11	7	201	3	42	5	6	21	133	69	7	5	49
4/27/2021	800	12	82	159	15	60	29	41	9	108	35	15	49	32
4/27/2021	800	13	12	224	26	31	35	27	4	147	29	37	33	14
4/27/2021	800	14	21	148	111	24	202	18	83	136	38	94	209	107
4/27/2021	745	15	147	687	95	98	299	54	35	248	61	34	233	43
4/27/2021	800	16	269	309	70	201	497	210	39	201	160	64	546	44
4/27/2021	800	17	31	101	73	127	399	67	140	442	28	152	605	737

Appendix B-4: PM Traffic Counts, 2021

60 Minute Counts

DATE	TIME	INTID	NBL	NBT	NBR	EBL	EBT	EBR	SBL	SBT	SBR	WBL	WBT	WBR
4/27/2021	1630	1	164	532	114	89	283	278	117	695	109	96	192	106
4/27/2021	1615	2	55	686	80	0	1	0	68	982	1	28	0	57
4/27/2021	1630	3	242	556	134	108	414	53	253	710	122	219	369	100
4/27/2021	1630	4	61	681	130	38	9	44	193	897	60	159	22	106
4/27/2021	1630	5	7	765	68	3	2	2	43	1083	0	45	2	33
4/27/2021	1630	6	74	830	212	2	0	0	118	989	0	219	0	82
4/27/2021	1615	7	37	14	52	29	575	42	33	17	22	111	605	21
4/27/2021	1645	8	0	0	0	0	808	0	0	0	21	0	691	43
4/27/2021	1700	9	0	0	33	0	985	37	0	0	0	53	1062	0
4/27/2021	1700	10	46	43	356	24	742	58	137	64	15	369	697	141
4/27/2021	1700	11	23	274	3	126	6	24	12	312	142	4	4	48
4/27/2021	1615	12	104	194	17	98	28	144	12	243	66	51	43	33
4/27/2021	1630	13	20	284	33	21	16	42	8	440	42	36	18	13
4/27/2021	1630	14	24	182	81	27	292	38	182	287	51	138	301	141
4/27/2021	1630	15	162	401	95	68	374	151	95	678	98	62	363	54
4/27/2021	1700	16	272	202	80	140	667	235	68	289	169	129	700	66
4/27/2021	1600	17	68	148	136	66	463	120	153	528	26	298	702	415

Appendix B-5: Adjusted 2021 AM Traffic Counts (1.84 AM Peak Hour Growth Factor)

60 Minute Counts

DATE	TIME	INTID	NBL	NBT	NBR	EBL	EBT	EBR	SBL	SBT	SBR	WBL	WBT	WBR
4/27/2021	800	1	351	951	155	175	359	173	140	604	177	98	543	213
4/27/2021	800	2	63	1165	121	0	0	0	121	762	0	59	0	186
4/27/2021	800	3	366	968	199	199	631	70	241	594	149	247	675	167
4/27/2021	800	4	53	1231	182	15	11	17	213	832	81	140	18	129
4/27/2021	800	5	26	1441	145	2	0	0	31	951	4	121	0	66
4/27/2021	800	6	52	1575	256	0	0	0	55	1064	0	359	2	182
4/27/2021	745	7	42	6	52	29	817	31	33	26	37	103	1135	31
4/27/2021	745	8	0	0	0	0	942	0	0	0	28	0	1249	46
4/27/2021	800	9	0	0	70	0	1413	35	0	0	0	230	1558	0
4/27/2021	800	10	101	61	377	50	902	68	289	68	26	340	1141	145
4/27/2021	745	11	13	370	6	77	9	11	39	245	127	13	9	90
4/27/2021	800	12	151	293	28	110	53	75	17	199	64	28	90	59
4/27/2021	800	13	22	412	48	57	64	50	7	270	53	68	61	26
4/27/2021	800	14	39	272	204	44	372	33	153	250	70	173	385	197
4/27/2021	745	15	270	1264	175	180	550	99	64	456	112	63	429	79
4/27/2021	800	16	495	569	129	370	914	386	72	370	294	118	1005	81
4/27/2021	800	17	57	186	134	234	734	123	258	813	52	280	1113	1356

Appendix B-6: Adjusted 2021 PM Traffic Counts (1.66 PM Peak Hour Growth Factor)

60 Minute Counts

DATE	TIME	INTID	NBL	NBT	NBR	EBL	EBT	EBR	SBL	SBT	SBR	WBL	WBT	WBR
4/27/2021	800	1	272	883	189	148	470	461	194	1154	181	159	319	176
4/27/2021	800	2	91	1139	133	0	2	0	113	1630	2	46	0	95
4/27/2021	800	3	402	923	222	179	687	88	420	1179	203	364	613	166
4/27/2021	800	4	101	1130	216	63	15	73	320	1489	100	264	37	176
4/27/2021	800	5	12	1270	113	5	3	3	71	1798	0	75	3	55
4/27/2021	800	6	123	1378	352	3	0	0	196	1642	0	364	0	136
4/27/2021	745	7	61	23	86	48	955	70	55	28	37	184	1004	35
4/27/2021	745	8	0	0	0	0	1341	0	0	0	35	0	1147	71
4/27/2021	800	9	0	0	55	0	1635	61	0	0	0	88	1763	0
4/27/2021	800	10	76	71	591	40	1232	96	227	106	25	613	1157	234
4/27/2021	745	11	38	455	5	209	10	40	20	518	236	7	7	80
4/27/2021	800	12	173	322	28	163	46	239	20	403	110	85	71	55
4/27/2021	800	13	33	471	55	35	27	70	13	730	70	60	30	22
4/27/2021	800	14	40	302	134	45	485	63	302	476	85	229	500	234
4/27/2021	745	15	269	666	158	113	621	251	158	1125	163	103	603	90
4/27/2021	800	16	452	335	133	232	1107	390	113	480	281	214	1162	110
4/27/2021	800	17	113	246	226	110	769	199	254	876	43	495	1165	689

Appendix C: Study Intersection LOS Calculations

San Antonio Village Phase III MTA
 SJ21-2068
 Existing AM

Level Of Service Computation Report
 2000 HCM Operations (Future Volume Alternative)
 Existing AM

Intersection #1: El Camino Real and Arastradero Road-Charleston Road

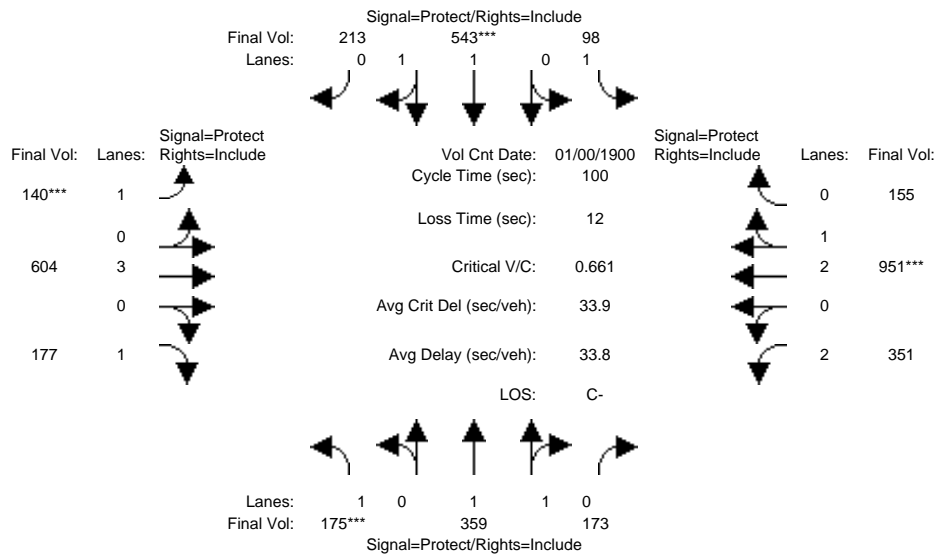

Approach:	North Bound			South Bound			East Bound			West Bound		
	L	T	R	L	T	R	L	T	R	L	T	R
Min. Green:	7	10	10	7	10	10	7	10	10	7	10	10
Y+R:	4.0	4.0	4.0	4.0	4.0	4.0	4.0	4.0	4.0	4.0	4.0	4.0

Volume Module:	>>	Count	Date:	0	Jan	1900	<<	12:00:00	AM			
Base Vol:	175	359	173	98	543	213	140	604	177	351	951	155
Growth Adj:	1.00	1.00	1.00	1.00	1.00	1.00	1.00	1.00	1.00	1.00	1.00	1.00
Initial Bse:	175	359	173	98	543	213	140	604	177	351	951	155
Added Vol:	0	0	0	0	0	0	0	0	0	0	0	0
PasserByVol:	0	0	0	0	0	0	0	0	0	0	0	0
Initial Fut:	175	359	173	98	543	213	140	604	177	351	951	155
User Adj:	1.00	1.00	1.00	1.00	1.00	1.00	1.00	1.00	1.00	1.00	1.00	1.00
PHF Adj:	1.00	1.00	1.00	1.00	1.00	1.00	1.00	1.00	1.00	1.00	1.00	1.00
PHF Volume:	175	359	173	98	543	213	140	604	177	351	951	155
Reduct Vol:	0	0	0	0	0	0	0	0	0	0	0	0
Reduced Vol:	175	359	173	98	543	213	140	604	177	351	951	155
PCE Adj:	1.00	1.00	1.00	1.00	1.00	1.00	1.00	1.00	1.00	1.00	1.00	1.00
MLF Adj:	1.00	1.00	1.00	1.00	1.00	1.00	1.00	1.00	1.00	1.00	1.00	1.00
Final Volume:	175	359	173	98	543	213	140	604	177	351	951	155

Saturation Flow Module:												
Sat/Lane:	1900	1900	1900	1900	1900	1900	1900	1900	1900	1900	1900	1900
Adjustment:	0.92	0.99	0.95	0.92	0.98	0.95	0.92	1.00	0.92	0.83	0.99	0.95
Lanes:	1.00	1.33	0.67	1.00	1.42	0.58	1.00	3.00	1.00	2.00	2.56	0.44
Final Sat.:	1750	2496	1203	1750	2657	1042	1750	5700	1750	3150	4814	785

Capacity Analysis Module:												
Vol/Sat:	0.10	0.14	0.14	0.06	0.20	0.20	0.08	0.11	0.10	0.11	0.20	0.20
Crit Moves:	****			****			****			****		
Green Time:	15.1	31.0	31.0	15.1	30.9	30.9	12.1	20.5	20.5	21.5	29.9	29.9
Volume/Cap:	0.66	0.46	0.46	0.37	0.66	0.66	0.66	0.52	0.49	0.52	0.66	0.66
Delay/Veh:	46.1	28.1	28.1	39.1	31.5	31.5	49.6	35.8	36.3	35.4	31.6	31.6
User DelAdj:	1.00	1.00	1.00	1.00	1.00	1.00	1.00	1.00	1.00	1.00	1.00	1.00
AdjDel/Veh:	46.1	28.1	28.1	39.1	31.5	31.5	49.6	35.8	36.3	35.4	31.6	31.6
LOS by Move:	D	C	C	D	C	C	D	D+	D+	D+	C	C
HCM2kAvgQ:	7	7	7	3	11	11	6	6	6	6	11	11

Note: Queue reported is the number of cars per lane.

San Antonio Village Phase III MTA
 SJ21-2068
 Existing AM

Level Of Service Computation Report
 2000 HCM Operations (Future Volume Alternative)
 Existing PP AM

Intersection #1: El Camino Real and Arastradero Road-Charleston Road

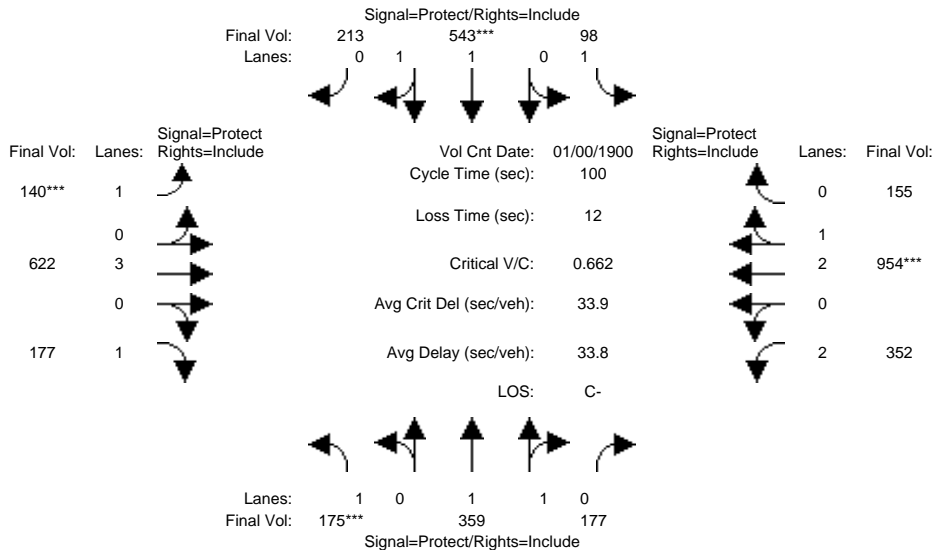

Approach:	North Bound			South Bound			East Bound			West Bound		
	L	T	R	L	T	R	L	T	R	L	T	R
Min. Green:	7	10	10	7	10	10	7	10	10	7	10	10
Y+R:	4.0	4.0	4.0	4.0	4.0	4.0	4.0	4.0	4.0	4.0	4.0	4.0
Volume Module: >> Count Date: 0 Jan 1900 << 12:00:00 AM												
Base Vol:	175	359	173	98	543	213	140	604	177	351	951	155
Growth Adj:	1.00	1.00	1.00	1.00	1.00	1.00	1.00	1.00	1.00	1.00	1.00	1.00
Initial Bse:	175	359	173	98	543	213	140	604	177	351	951	155
Added Vol:	0	0	4	0	0	0	0	18	0	1	3	0
PasserByVol:	0	0	0	0	0	0	0	0	0	0	0	0
Initial Fut:	175	359	177	98	543	213	140	622	177	352	954	155
User Adj:	1.00	1.00	1.00	1.00	1.00	1.00	1.00	1.00	1.00	1.00	1.00	1.00
PHF Adj:	1.00	1.00	1.00	1.00	1.00	1.00	1.00	1.00	1.00	1.00	1.00	1.00
PHF Volume:	175	359	177	98	543	213	140	622	177	352	954	155
Reduct Vol:	0	0	0	0	0	0	0	0	0	0	0	0
Reduced Vol:	175	359	177	98	543	213	140	622	177	352	954	155
PCE Adj:	1.00	1.00	1.00	1.00	1.00	1.00	1.00	1.00	1.00	1.00	1.00	1.00
MLF Adj:	1.00	1.00	1.00	1.00	1.00	1.00	1.00	1.00	1.00	1.00	1.00	1.00
Final Volume:	175	359	177	98	543	213	140	622	177	352	954	155
Saturation Flow Module:												
Sat/Lane:	1900	1900	1900	1900	1900	1900	1900	1900	1900	1900	1900	1900
Adjustment:	0.92	0.99	0.95	0.92	0.98	0.95	0.92	1.00	0.92	0.83	0.99	0.95
Lanes:	1.00	1.32	0.68	1.00	1.42	0.58	1.00	3.00	1.00	2.00	2.57	0.43
Final Sat.:	1750	2477	1221	1750	2657	1042	1750	5700	1750	3150	4816	783
Capacity Analysis Module:												
Vol/Sat:	0.10	0.14	0.14	0.06	0.20	0.20	0.08	0.11	0.10	0.11	0.20	0.20
Crit Moves:	****			****			****			****		
Green Time:	15.1	31.0	31.0	15.0	30.9	30.9	12.1	20.8	20.8	21.3	29.9	29.9
Volume/Cap:	0.66	0.47	0.47	0.37	0.66	0.66	0.66	0.53	0.49	0.53	0.66	0.66
Delay/Veh:	46.2	28.1	28.1	39.2	31.5	31.5	49.6	35.7	36.0	35.7	31.6	31.6
User DelAdj:	1.00	1.00	1.00	1.00	1.00	1.00	1.00	1.00	1.00	1.00	1.00	1.00
AdjDel/Veh:	46.2	28.1	28.1	39.2	31.5	31.5	49.6	35.7	36.0	35.7	31.6	31.6
LOS by Move:	D	C	C	D	C	C	D	D+	D+	D+	C	C
HCM2kAvgQ:	7	7	7	3	11	11	6	6	6	6	11	11

Note: Queue reported is the number of cars per lane.

San Antonio Village Phase III MTA
 SJ21-2068
 Existing AM

Level Of Service Computation Report
 2000 HCM Operations (Future Volume Alternative)
 Existing AM

Intersection #2: El Camino Real and Del Medio Avenue

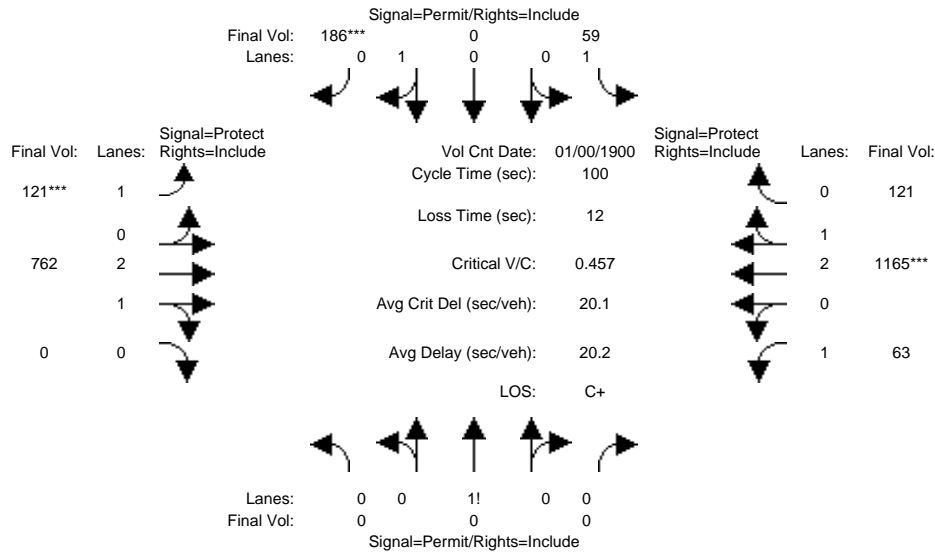

Approach:	North Bound			South Bound			East Bound			West Bound		
	L	T	R	L	T	R	L	T	R	L	T	R
Min. Green:	10	10	10	10	10	10	7	10	10	7	10	10
Y+R:	4.0	4.0	4.0	4.0	4.0	4.0	4.0	4.0	4.0	4.0	4.0	4.0
Volume Module: >> Count Date: 0 Jan 1900 << 12:00:00 AM												
Base Vol:	0	0	0	59	0	186	121	762	0	63	1165	121
Growth Adj:	1.00	1.00	1.00	1.00	1.00	1.00	1.00	1.00	1.00	1.00	1.00	1.00
Initial Bse:	0	0	0	59	0	186	121	762	0	63	1165	121
Added Vol:	0	0	0	0	0	0	0	0	0	0	0	0
PasserByVol:	0	0	0	0	0	0	0	0	0	0	0	0
Initial Fut:	0	0	0	59	0	186	121	762	0	63	1165	121
User Adj:	1.00	1.00	1.00	1.00	1.00	1.00	1.00	1.00	1.00	1.00	1.00	1.00
PHF Adj:	1.00	1.00	1.00	1.00	1.00	1.00	1.00	1.00	1.00	1.00	1.00	1.00
PHF Volume:	0	0	0	59	0	186	121	762	0	63	1165	121
Reduct Vol:	0	0	0	0	0	0	0	0	0	0	0	0
Reduced Vol:	0	0	0	59	0	186	121	762	0	63	1165	121
PCE Adj:	1.00	1.00	1.00	1.00	1.00	1.00	1.00	1.00	1.00	1.00	1.00	1.00
MLF Adj:	1.00	1.00	1.00	1.00	1.00	1.00	1.00	1.00	1.00	1.00	1.00	1.00
FinalVolume:	0	0	0	59	0	186	121	762	0	63	1165	121
Saturation Flow Module:												
Sat/Lane:	1900	1900	1900	1900	1900	1900	1900	1900	1900	1900	1900	1900
Adjustment:	0.92	0.92	0.92	0.92	1.00	0.95	0.92	0.98	0.92	0.92	0.99	0.95
Lanes:	0.00	1.00	0.00	1.00	0.00	1.00	1.00	3.00	0.00	1.00	2.71	0.29
Final Sat.:	0	1750	0	1750	0	1800	1750	5600	0	1750	5072	527
Capacity Analysis Module:												
Vol/Sat:	0.00	0.00	0.00	0.03	0.00	0.10	0.07	0.14	0.00	0.04	0.23	0.23
Crit Moves:				****			****			****		
Green Time:	0.0	0.0	0.0	22.6	0.0	22.6	15.1	43.2	0.0	22.2	50.3	50.3
Volume/Cap:	0.00	0.00	0.00	0.15	0.00	0.46	0.46	0.32	0.00	0.16	0.46	0.46
Delay/Veh:	0.0	0.0	0.0	31.2	0.0	34.2	39.9	18.8	0.0	31.6	16.2	16.2
User DelAdj:	1.00	1.00	1.00	1.00	1.00	1.00	1.00	1.00	1.00	1.00	1.00	1.00
AdjDel/Veh:	0.0	0.0	0.0	31.2	0.0	34.2	39.9	18.8	0.0	31.6	16.2	16.2
LOS by Move:	A	A	A	C	A	C-	D	B-	A	C	B	B
HCM2kAvgQ:	0	0	0	2	0	6	4	5	0	2	8	8

Note: Queue reported is the number of cars per lane.

San Antonio Village Phase III MTA
 SJ21-2068
 Existing AM

Level Of Service Computation Report
 2000 HCM Operations (Future Volume Alternative)
 Existing PP AM

Intersection #2: El Camino Real and Del Medio Avenue

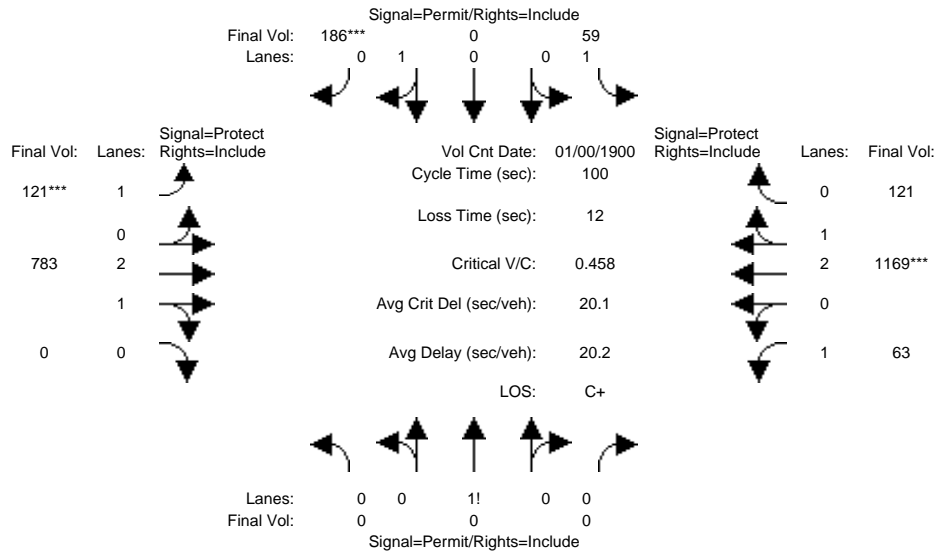

Approach:	North Bound			South Bound			East Bound			West Bound		
	L	T	R	L	T	R	L	T	R	L	T	R
Min. Green:	10	10	10	10	10	10	7	10	10	7	10	10
Y+R:	4.0	4.0	4.0	4.0	4.0	4.0	4.0	4.0	4.0	4.0	4.0	4.0
Volume Module: >> Count Date: 0 Jan 1900 << 12:00:00 AM												
Base Vol:	0	0	0	59	0	186	121	762	0	63	1165	121
Growth Adj:	1.00	1.00	1.00	1.00	1.00	1.00	1.00	1.00	1.00	1.00	1.00	1.00
Initial Bse:	0	0	0	59	0	186	121	762	0	63	1165	121
Added Vol:	0	0	0	0	0	0	0	21	0	0	4	0
PasserByVol:	0	0	0	0	0	0	0	0	0	0	0	0
Initial Fut:	0	0	0	59	0	186	121	783	0	63	1169	121
User Adj:	1.00	1.00	1.00	1.00	1.00	1.00	1.00	1.00	1.00	1.00	1.00	1.00
PHF Adj:	1.00	1.00	1.00	1.00	1.00	1.00	1.00	1.00	1.00	1.00	1.00	1.00
PHF Volume:	0	0	0	59	0	186	121	783	0	63	1169	121
Reduct Vol:	0	0	0	0	0	0	0	0	0	0	0	0
Reduced Vol:	0	0	0	59	0	186	121	783	0	63	1169	121
PCE Adj:	1.00	1.00	1.00	1.00	1.00	1.00	1.00	1.00	1.00	1.00	1.00	1.00
MLF Adj:	1.00	1.00	1.00	1.00	1.00	1.00	1.00	1.00	1.00	1.00	1.00	1.00
FinalVolume:	0	0	0	59	0	186	121	783	0	63	1169	121
Saturation Flow Module:												
Sat/Lane:	1900	1900	1900	1900	1900	1900	1900	1900	1900	1900	1900	1900
Adjustment:	0.92	0.92	0.92	0.92	1.00	0.95	0.92	0.98	0.92	0.92	0.99	0.95
Lanes:	0.00	1.00	0.00	1.00	0.00	1.00	1.00	3.00	0.00	1.00	2.71	0.29
Final Sat.:	0	1750	0	1750	0	1800	1750	5600	0	1750	5074	525
Capacity Analysis Module:												
Vol/Sat:	0.00	0.00	0.00	0.03	0.00	0.10	0.07	0.14	0.00	0.04	0.23	0.23
Crit Moves:						****	****				****	
Green Time:	0.0	0.0	0.0	22.6	0.0	22.6	15.1	43.6	0.0	21.8	50.3	50.3
Volume/Cap:	0.00	0.00	0.00	0.15	0.00	0.46	0.46	0.32	0.00	0.16	0.46	0.46
Delay/Veh:	0.0	0.0	0.0	31.2	0.0	34.3	40.0	18.6	0.0	31.9	16.2	16.2
User DelAdj:	1.00	1.00	1.00	1.00	1.00	1.00	1.00	1.00	1.00	1.00	1.00	1.00
AdjDel/Veh:	0.0	0.0	0.0	31.2	0.0	34.3	40.0	18.6	0.0	31.9	16.2	16.2
LOS by Move:	A	A	A	C	A	C-	D	B-	A	C	B	B
HCM2kAvgQ:	0	0	0	2	0	6	4	5	0	2	8	8

Note: Queue reported is the number of cars per lane.

San Antonio Village Phase III MTA
 SJ21-2068
 Existing AM

Level Of Service Computation Report
 2000 HCM Operations (Future Volume Alternative)
 Existing AM

Intersection #3: El Camino Real and San Antonio Road

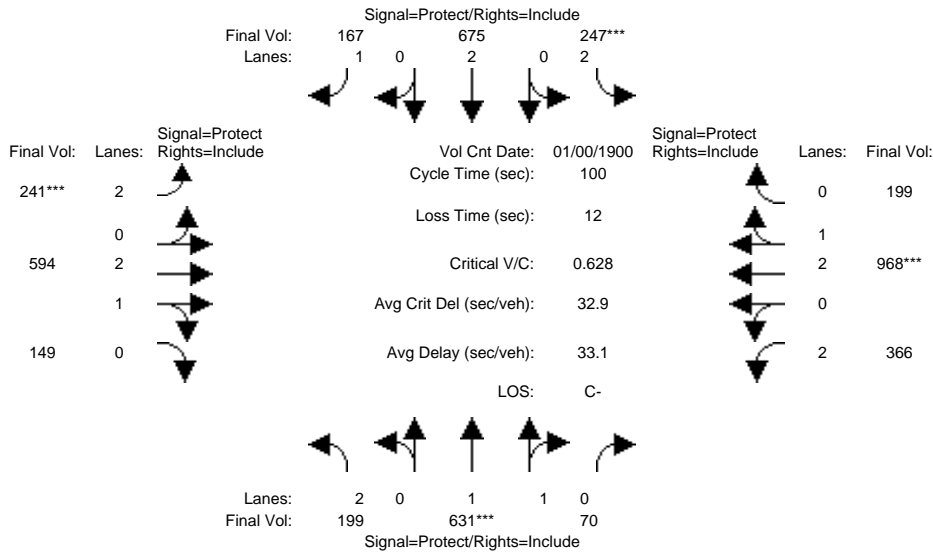

Approach:	North Bound			South Bound			East Bound			West Bound		
	L	T	R	L	T	R	L	T	R	L	T	R
Min. Green:	7	10	10	7	10	10	7	10	10	7	10	10
Y+R:	4.0	4.0	4.0	4.0	4.0	4.0	4.0	4.0	4.0	4.0	4.0	4.0
Volume Module: >> Count Date: 0 Jan 1900 << 12:00:00 AM												
Base Vol:	199	631	70	247	675	167	241	594	149	366	968	199
Growth Adj:	1.00	1.00	1.00	1.00	1.00	1.00	1.00	1.00	1.00	1.00	1.00	1.00
Initial Bse:	199	631	70	247	675	167	241	594	149	366	968	199
Added Vol:	0	0	0	0	0	0	0	0	0	0	0	0
PasserByVol:	0	0	0	0	0	0	0	0	0	0	0	0
Initial Fut:	199	631	70	247	675	167	241	594	149	366	968	199
User Adj:	1.00	1.00	1.00	1.00	1.00	1.00	1.00	1.00	1.00	1.00	1.00	1.00
PHF Adj:	1.00	1.00	1.00	1.00	1.00	1.00	1.00	1.00	1.00	1.00	1.00	1.00
PHF Volume:	199	631	70	247	675	167	241	594	149	366	968	199
Reduct Vol:	0	0	0	0	0	0	0	0	0	0	0	0
Reduced Vol:	199	631	70	247	675	167	241	594	149	366	968	199
PCE Adj:	1.00	1.00	1.00	1.00	1.00	1.00	1.00	1.00	1.00	1.00	1.00	1.00
MLF Adj:	1.00	1.00	1.00	1.00	1.00	1.00	1.00	1.00	1.00	1.00	1.00	1.00
FinalVolume:	199	631	70	247	675	167	241	594	149	366	968	199
Saturation Flow Module:												
Sat/Lane:	1900	1900	1900	1900	1900	1900	1900	1900	1900	1900	1900	1900
Adjustment:	0.83	0.98	0.95	0.83	1.00	0.92	0.83	0.99	0.95	0.83	0.99	0.95
Lanes:	2.00	1.79	0.21	2.00	2.00	1.00	2.00	2.38	0.62	2.00	2.47	0.53
Final Sat.:	3150	3330	369	3150	3800	1750	3150	4476	1123	3150	4644	955
Capacity Analysis Module:												
Vol/Sat:	0.06	0.19	0.19	0.08	0.18	0.10	0.08	0.13	0.13	0.12	0.21	0.21
Crit Moves:	****			****			****			****		
Green Time:	12.1	30.2	30.2	12.5	30.6	30.6	12.2	24.2	24.2	21.2	33.2	33.2
Volume/Cap:	0.52	0.63	0.63	0.63	0.58	0.31	0.63	0.55	0.55	0.55	0.63	0.63
Delay/Veh:	42.6	31.2	31.2	44.8	30.0	27.0	45.1	33.6	33.6	36.1	28.9	28.9
User DelAdj:	1.00	1.00	1.00	1.00	1.00	1.00	1.00	1.00	1.00	1.00	1.00	1.00
AdjDel/Veh:	42.6	31.2	31.2	44.8	30.0	27.0	45.1	33.6	33.6	36.1	28.9	28.9
LOS by Move:	D	C	C	D	C	C	D	C-	C-	D+	C	C
HCM2kAvgQ:	4	10	10	4	9	4	4	7	7	7	11	11

Note: Queue reported is the number of cars per lane.

San Antonio Village Phase III MTA
 SJ21-2068
 Existing AM

Level Of Service Computation Report
 2000 HCM Operations (Future Volume Alternative)
 Existing PP AM

Intersection #3: El Camino Real and San Antonio Road

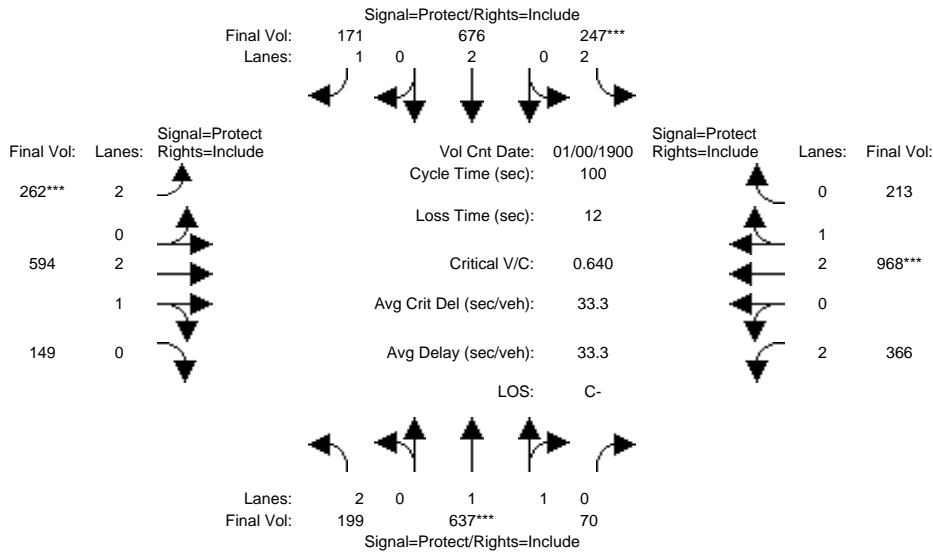

Approach:	North Bound			South Bound			East Bound			West Bound		
	L	T	R	L	T	R	L	T	R	L	T	R
Min. Green:	7	10	10	7	10	10	7	10	10	7	10	10
Y+R:	4.0	4.0	4.0	4.0	4.0	4.0	4.0	4.0	4.0	4.0	4.0	4.0
Volume Module: >> Count Date: 0 Jan 1900 << 12:00:00 AM												
Base Vol:	199	631	70	247	675	167	241	594	149	366	968	199
Growth Adj:	1.00	1.00	1.00	1.00	1.00	1.00	1.00	1.00	1.00	1.00	1.00	1.00
Initial Bse:	199	631	70	247	675	167	241	594	149	366	968	199
Added Vol:	0	6	0	0	1	4	21	0	0	0	0	14
PasserByVol:	0	0	0	0	0	0	0	0	0	0	0	0
Initial Fut:	199	637	70	247	676	171	262	594	149	366	968	213
User Adj:	1.00	1.00	1.00	1.00	1.00	1.00	1.00	1.00	1.00	1.00	1.00	1.00
PHF Adj:	1.00	1.00	1.00	1.00	1.00	1.00	1.00	1.00	1.00	1.00	1.00	1.00
PHF Volume:	199	637	70	247	676	171	262	594	149	366	968	213
Reduct Vol:	0	0	0	0	0	0	0	0	0	0	0	0
Reduced Vol:	199	637	70	247	676	171	262	594	149	366	968	213
PCE Adj:	1.00	1.00	1.00	1.00	1.00	1.00	1.00	1.00	1.00	1.00	1.00	1.00
MLF Adj:	1.00	1.00	1.00	1.00	1.00	1.00	1.00	1.00	1.00	1.00	1.00	1.00
Final Volume:	199	637	70	247	676	171	262	594	149	366	968	213
Saturation Flow Module:												
Sat/Lane:	1900	1900	1900	1900	1900	1900	1900	1900	1900	1900	1900	1900
Adjustment:	0.83	0.98	0.95	0.83	1.00	0.92	0.83	0.99	0.95	0.83	0.99	0.95
Lanes:	2.00	1.80	0.20	2.00	2.00	1.00	2.00	2.38	0.62	2.00	2.44	0.56
Final Sat.:	3150	3333	366	3150	3800	1750	3150	4476	1123	3150	4589	1010
Capacity Analysis Module:												
Vol/Sat:	0.06	0.19	0.19	0.08	0.18	0.10	0.08	0.13	0.13	0.12	0.21	0.21
Crit Moves:	****			****			****			****		
Green Time:	11.9	29.8	29.8	12.2	30.2	30.2	13.0	24.5	24.5	21.4	32.9	32.9
Volume/Cap:	0.53	0.64	0.64	0.64	0.59	0.32	0.64	0.54	0.54	0.54	0.64	0.64
Delay/Veh:	42.9	31.7	31.7	45.4	30.4	27.4	44.7	33.3	33.3	35.8	29.3	29.3
User DelAdj:	1.00	1.00	1.00	1.00	1.00	1.00	1.00	1.00	1.00	1.00	1.00	1.00
AdjDel/Veh:	42.9	31.7	31.7	45.4	30.4	27.4	44.7	33.3	33.3	35.8	29.3	29.3
LOS by Move:	D	C	C	D	C	C	D	C-	C-	D+	C	C
HCM2kAvgQ:	4	10	10	4	9	4	5	7	7	7	11	11

Note: Queue reported is the number of cars per lane.

San Antonio Village Phase III MTA
 SJ21-2068
 Existing AM

Level Of Service Computation Report
 2000 HCM Operations (Future Volume Alternative)
 Existing AM

Intersection #4: El Camino Real and Showers Drive

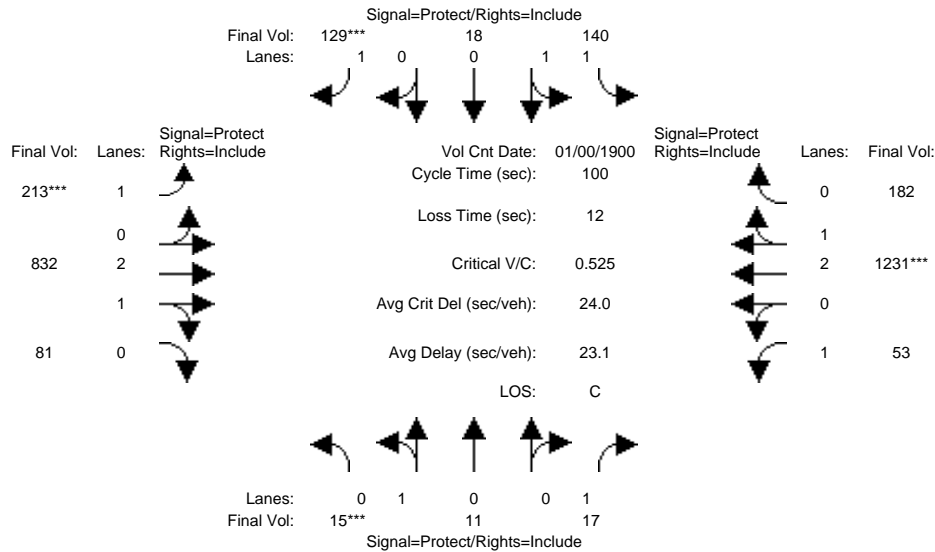

Approach:	North Bound			South Bound			East Bound			West Bound		
	L	T	R	L	T	R	L	T	R	L	T	R
Min. Green:	7	10	10	7	10	10	7	10	10	7	10	10
Y+R:	4.0	4.0	4.0	4.0	4.0	4.0	4.0	4.0	4.0	4.0	4.0	4.0
Volume Module: >> Count Date: 0 Jan 1900 << 12:00:00 AM												
Base Vol:	15	11	17	140	18	129	213	832	81	53	1231	182
Growth Adj:	1.00	1.00	1.00	1.00	1.00	1.00	1.00	1.00	1.00	1.00	1.00	1.00
Initial Bse:	15	11	17	140	18	129	213	832	81	53	1231	182
Added Vol:	0	0	0	0	0	0	0	0	0	0	0	0
PasserByVol:	0	0	0	0	0	0	0	0	0	0	0	0
Initial Fut:	15	11	17	140	18	129	213	832	81	53	1231	182
User Adj:	1.00	1.00	1.00	1.00	1.00	1.00	1.00	1.00	1.00	1.00	1.00	1.00
PHF Adj:	1.00	1.00	1.00	1.00	1.00	1.00	1.00	1.00	1.00	1.00	1.00	1.00
PHF Volume:	15	11	17	140	18	129	213	832	81	53	1231	182
Reduct Vol:	0	0	0	0	0	0	0	0	0	0	0	0
Reduced Vol:	15	11	17	140	18	129	213	832	81	53	1231	182
PCE Adj:	1.00	1.00	1.00	1.00	1.00	1.00	1.00	1.00	1.00	1.00	1.00	1.00
MLF Adj:	1.00	1.00	1.00	1.00	1.00	1.00	1.00	1.00	1.00	1.00	1.00	1.00
FinalVolume:	15	11	17	140	18	129	213	832	81	53	1231	182
Saturation Flow Module:												
Sat/Lane:	1900	1900	1900	1900	1900	1900	1900	1900	1900	1900	1900	1900
Adjustment:	0.95	0.95	0.92	0.93	0.95	0.92	0.92	0.99	0.95	0.92	0.99	0.95
Lanes:	0.58	0.42	1.00	1.78	0.22	1.00	1.00	2.72	0.28	1.00	2.60	0.40
Final Sat.:	1038	762	1750	3145	404	1750	1750	5103	497	1750	4878	721
Capacity Analysis Module:												
Vol/Sat:	0.01	0.01	0.01	0.04	0.04	0.07	0.12	0.16	0.16	0.03	0.25	0.25
Crit Moves:	****					****	****				****	
Green Time:	7.0	12.0	12.0	8.4	13.3	13.3	22.0	47.3	47.3	20.3	45.6	45.6
Volume/Cap:	0.21	0.12	0.08	0.53	0.33	0.55	0.55	0.34	0.34	0.15	0.55	0.55
Delay/Veh:	44.7	39.6	39.3	45.8	39.7	43.4	36.4	16.6	16.6	32.9	20.0	20.0
User DelAdj:	1.00	1.00	1.00	1.00	1.00	1.00	1.00	1.00	1.00	1.00	1.00	1.00
AdjDel/Veh:	44.7	39.6	39.3	45.8	39.7	43.4	36.4	16.6	16.6	32.9	20.0	20.0
LOS by Move:	D	D	D	D	D	D	D+	B	B	C-	C+	C+
HCM2kAvgQ:	1	1	1	3	2	4	7	6	6	1	11	11

Note: Queue reported is the number of cars per lane.

San Antonio Village Phase III MTA
 SJ21-2068
 Existing AM

Level Of Service Computation Report
 2000 HCM Operations (Future Volume Alternative)
 Existing PP AM

Intersection #4: El Camino Real and Showers Drive

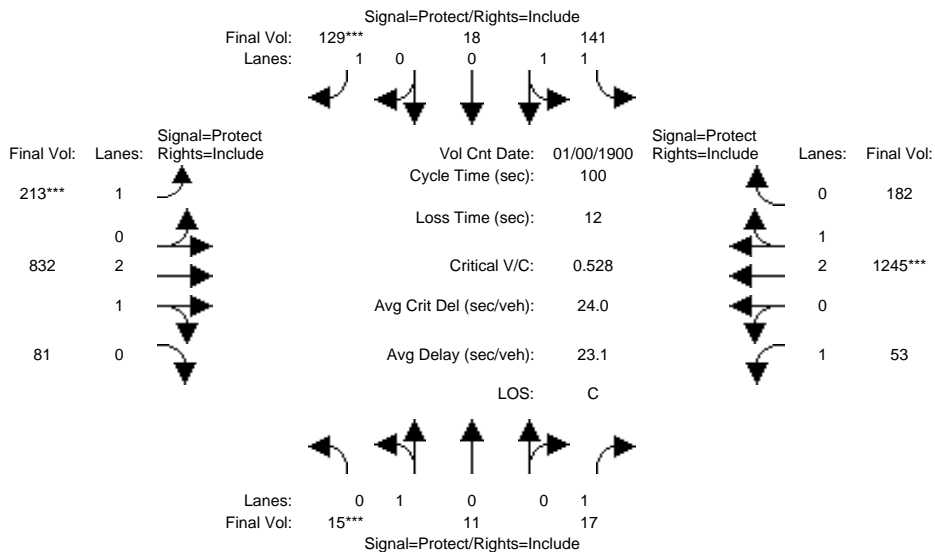

Approach:	North Bound			South Bound			East Bound			West Bound		
Movement:	L	T	R	L	T	R	L	T	R	L	T	R
Min. Green:	7	10	10	7	10	10	7	10	10	7	10	10
Y+R:	4.0	4.0	4.0	4.0	4.0	4.0	4.0	4.0	4.0	4.0	4.0	4.0
Volume Module: >> Count Date: 0 Jan 1900 << 12:00:00 AM												
Base Vol:	15	11	17	140	18	129	213	832	81	53	1231	182
Growth Adj:	1.00	1.00	1.00	1.00	1.00	1.00	1.00	1.00	1.00	1.00	1.00	1.00
Initial Bse:	15	11	17	140	18	129	213	832	81	53	1231	182
Added Vol:	0	0	0	1	0	0	0	0	0	0	14	0
PasserByVol:	0	0	0	0	0	0	0	0	0	0	0	0
Initial Fut:	15	11	17	141	18	129	213	832	81	53	1245	182
User Adj:	1.00	1.00	1.00	1.00	1.00	1.00	1.00	1.00	1.00	1.00	1.00	1.00
PHF Adj:	1.00	1.00	1.00	1.00	1.00	1.00	1.00	1.00	1.00	1.00	1.00	1.00
PHF Volume:	15	11	17	141	18	129	213	832	81	53	1245	182
Reduct Vol:	0	0	0	0	0	0	0	0	0	0	0	0
Reduced Vol:	15	11	17	141	18	129	213	832	81	53	1245	182
PCE Adj:	1.00	1.00	1.00	1.00	1.00	1.00	1.00	1.00	1.00	1.00	1.00	1.00
MLF Adj:	1.00	1.00	1.00	1.00	1.00	1.00	1.00	1.00	1.00	1.00	1.00	1.00
FinalVolume:	15	11	17	141	18	129	213	832	81	53	1245	182
Saturation Flow Module:												
Sat/Lane:	1900	1900	1900	1900	1900	1900	1900	1900	1900	1900	1900	1900
Adjustment:	0.95	0.95	0.92	0.93	0.95	0.92	0.92	0.99	0.95	0.92	0.99	0.95
Lanes:	0.58	0.42	1.00	1.78	0.22	1.00	1.00	2.72	0.28	1.00	2.60	0.40
Final Sat.:	1038	762	1750	3148	402	1750	1750	5103	497	1750	4885	714
Capacity Analysis Module:												
Vol/Sat:	0.01	0.01	0.01	0.04	0.04	0.07	0.12	0.16	0.16	0.03	0.25	0.25
Crit Moves:	****					****	****				****	
Green Time:	7.0	11.9	11.9	8.3	13.3	13.3	21.9	47.4	47.4	20.3	45.8	45.8
Volume/Cap:	0.21	0.12	0.08	0.54	0.34	0.56	0.56	0.34	0.34	0.15	0.56	0.56
Delay/Veh:	44.7	39.6	39.3	45.9	39.8	43.6	36.5	16.6	16.6	32.9	19.9	19.9
User DelAdj:	1.00	1.00	1.00	1.00	1.00	1.00	1.00	1.00	1.00	1.00	1.00	1.00
AdjDel/Veh:	44.7	39.6	39.3	45.9	39.8	43.6	36.5	16.6	16.6	32.9	19.9	19.9
LOS by Move:	D	D	D	D	D	D	D+	B	B	C-	B-	B-
HCM2kAvgQ:	1	1	1	3	2	4	7	6	6	1	11	11

Note: Queue reported is the number of cars per lane.

San Antonio Village Phase III MTA
 SJ21-2068
 Existing AM

Level Of Service Computation Report
 2000 HCM Operations (Future Volume Alternative)
 Existing AM

Intersection #5: El Camino Real and Ortega Avenue

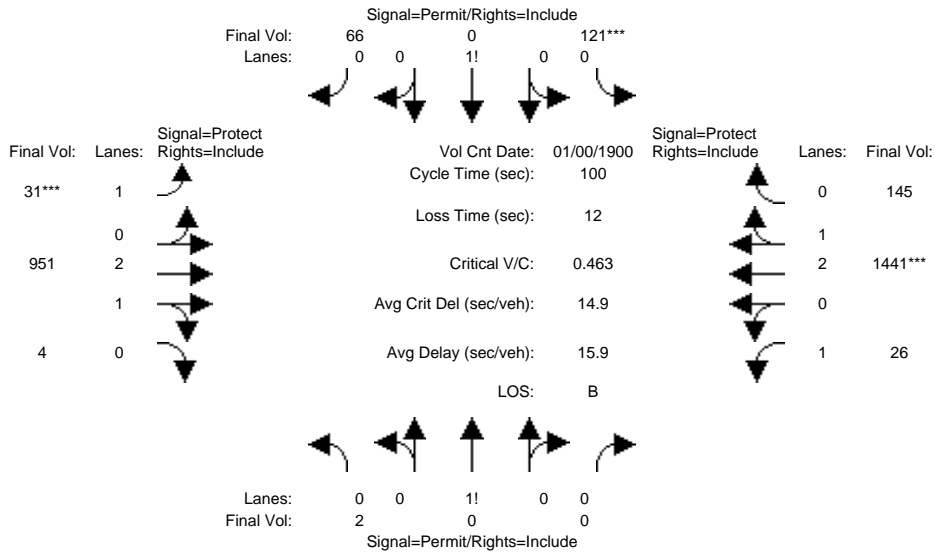

Approach:	North Bound			South Bound			East Bound			West Bound		
	L	T	R	L	T	R	L	T	R	L	T	R
Min. Green:	10	10	10	10	10	10	7	10	10	7	10	10
Y+R:	4.0	4.0	4.0	4.0	4.0	4.0	4.0	4.0	4.0	4.0	4.0	4.0
Volume Module: >> Count Date: 0 Jan 1900 << 12:00:00 AM												
Base Vol:	2	0	0	121	0	66	31	951	4	26	1441	145
Growth Adj:	1.00	1.00	1.00	1.00	1.00	1.00	1.00	1.00	1.00	1.00	1.00	1.00
Initial Bse:	2	0	0	121	0	66	31	951	4	26	1441	145
Added Vol:	0	0	0	0	0	0	0	0	0	0	0	0
PasserByVol:	0	0	0	0	0	0	0	0	0	0	0	0
Initial Fut:	2	0	0	121	0	66	31	951	4	26	1441	145
User Adj:	1.00	1.00	1.00	1.00	1.00	1.00	1.00	1.00	1.00	1.00	1.00	1.00
PHF Adj:	1.00	1.00	1.00	1.00	1.00	1.00	1.00	1.00	1.00	1.00	1.00	1.00
PHF Volume:	2	0	0	121	0	66	31	951	4	26	1441	145
Reduct Vol:	0	0	0	0	0	0	0	0	0	0	0	0
Reduced Vol:	2	0	0	121	0	66	31	951	4	26	1441	145
PCE Adj:	1.00	1.00	1.00	1.00	1.00	1.00	1.00	1.00	1.00	1.00	1.00	1.00
MLF Adj:	1.00	1.00	1.00	1.00	1.00	1.00	1.00	1.00	1.00	1.00	1.00	1.00
Final Volume:	2	0	0	121	0	66	31	951	4	26	1441	145
Saturation Flow Module:												
Sat/Lane:	1900	1900	1900	1900	1900	1900	1900	1900	1900	1900	1900	1900
Adjustment:	0.92	1.00	0.92	0.92	0.92	0.92	0.92	0.98	0.95	0.92	0.99	0.95
Lanes:	1.00	0.00	0.00	0.65	0.00	0.35	1.00	2.99	0.01	1.00	2.72	0.28
Final Sat.:	1750	0	0	1132	0	618	1750	5577	23	1750	5087	512
Capacity Analysis Module:												
Vol/Sat:	0.00	0.00	0.00	0.11	0.00	0.11	0.02	0.17	0.17	0.01	0.28	0.28
Crit Moves:				****				****				****
Green Time:	22.2	0.0	0.0	22.2	0.0	22.2	7.0	46.7	46.7	19.2	58.8	58.8
Volume/Cap:	0.01	0.00	0.00	0.48	0.00	0.48	0.25	0.37	0.37	0.08	0.48	0.48
Delay/Veh:	30.3	0.0	0.0	34.8	0.0	34.8	45.1	17.2	17.2	33.3	11.9	11.9
User DelAdj:	1.00	1.00	1.00	1.00	1.00	1.00	1.00	1.00	1.00	1.00	1.00	1.00
AdjDel/Veh:	30.3	0.0	0.0	34.8	0.0	34.8	45.1	17.2	17.2	33.3	11.9	11.9
LOS by Move:	C	A	A	C-	A	C-	D	B	B	C-	B+	B+
HCM2kAvgQ:	0	0	0	6	0	6	1	6	6	1	10	10

Note: Queue reported is the number of cars per lane.

San Antonio Village Phase III MTA
 SJ21-2068
 Existing AM

Level Of Service Computation Report
 2000 HCM Operations (Future Volume Alternative)
 Existing PP AM

Intersection #5: El Camino Real and Ortega Avenue

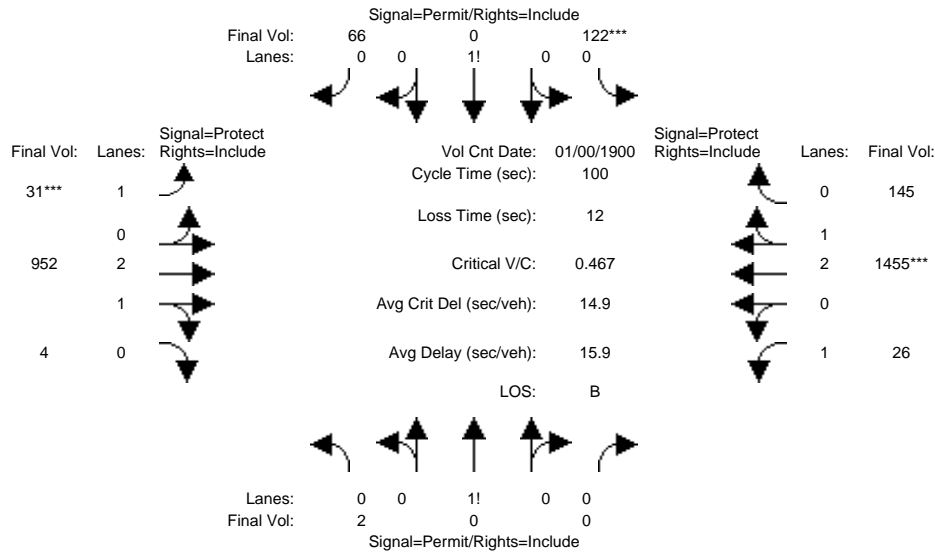

Approach:	North Bound			South Bound			East Bound			West Bound		
	L	T	R	L	T	R	L	T	R	L	T	R
Min. Green:	10	10	10	10	10	10	7	10	10	7	10	10
Y+R:	4.0	4.0	4.0	4.0	4.0	4.0	4.0	4.0	4.0	4.0	4.0	4.0
Volume Module: >> Count Date: 0 Jan 1900 << 12:00:00 AM												
Base Vol:	2	0	0	121	0	66	31	951	4	26	1441	145
Growth Adj:	1.00	1.00	1.00	1.00	1.00	1.00	1.00	1.00	1.00	1.00	1.00	1.00
Initial Bse:	2	0	0	121	0	66	31	951	4	26	1441	145
Added Vol:	0	0	0	1	0	0	0	1	0	0	14	0
PasserByVol:	0	0	0	0	0	0	0	0	0	0	0	0
Initial Fut:	2	0	0	122	0	66	31	952	4	26	1455	145
User Adj:	1.00	1.00	1.00	1.00	1.00	1.00	1.00	1.00	1.00	1.00	1.00	1.00
PHF Adj:	1.00	1.00	1.00	1.00	1.00	1.00	1.00	1.00	1.00	1.00	1.00	1.00
PHF Volume:	2	0	0	122	0	66	31	952	4	26	1455	145
Reduct Vol:	0	0	0	0	0	0	0	0	0	0	0	0
Reduced Vol:	2	0	0	122	0	66	31	952	4	26	1455	145
PCE Adj:	1.00	1.00	1.00	1.00	1.00	1.00	1.00	1.00	1.00	1.00	1.00	1.00
MLF Adj:	1.00	1.00	1.00	1.00	1.00	1.00	1.00	1.00	1.00	1.00	1.00	1.00
Final Volume:	2	0	0	122	0	66	31	952	4	26	1455	145
Saturation Flow Module:												
Sat/Lane:	1900	1900	1900	1900	1900	1900	1900	1900	1900	1900	1900	1900
Adjustment:	0.92	1.00	0.92	0.92	0.92	0.92	0.92	0.98	0.95	0.92	0.99	0.95
Lanes:	1.00	0.00	0.00	0.65	0.00	0.35	1.00	2.99	0.01	1.00	2.72	0.28
Final Sat.:	1750	0	0	1136	0	614	1750	5577	23	1750	5092	507
Capacity Analysis Module:												
Vol/Sat:	0.00	0.00	0.00	0.11	0.00	0.11	0.02	0.17	0.17	0.01	0.29	0.29
Crit Moves:				****				****				****
Green Time:	22.1	0.0	0.0	22.1	0.0	22.1	7.0	46.7	46.7	19.2	58.9	58.9
Volume/Cap:	0.01	0.00	0.00	0.49	0.00	0.49	0.25	0.37	0.37	0.08	0.49	0.49
Delay/Veh:	30.4	0.0	0.0	34.9	0.0	34.9	45.1	17.2	17.2	33.3	12.0	12.0
User DelAdj:	1.00	1.00	1.00	1.00	1.00	1.00	1.00	1.00	1.00	1.00	1.00	1.00
AdjDel/Veh:	30.4	0.0	0.0	34.9	0.0	34.9	45.1	17.2	17.2	33.3	12.0	12.0
LOS by Move:	C	A	A	C-	A	C-	D	B	B	C-	B+	B+
HCM2kAvgQ:	0	0	0	6	0	6	1	6	6	1	10	10

Note: Queue reported is the number of cars per lane.

San Antonio Village Phase III MTA
 SJ21-2068
 Existing AM

Level Of Service Computation Report
 2000 HCM Operations (Future Volume Alternative)
 Existing AM

Intersection #6: El Camino Real and Rengstorff Avenue

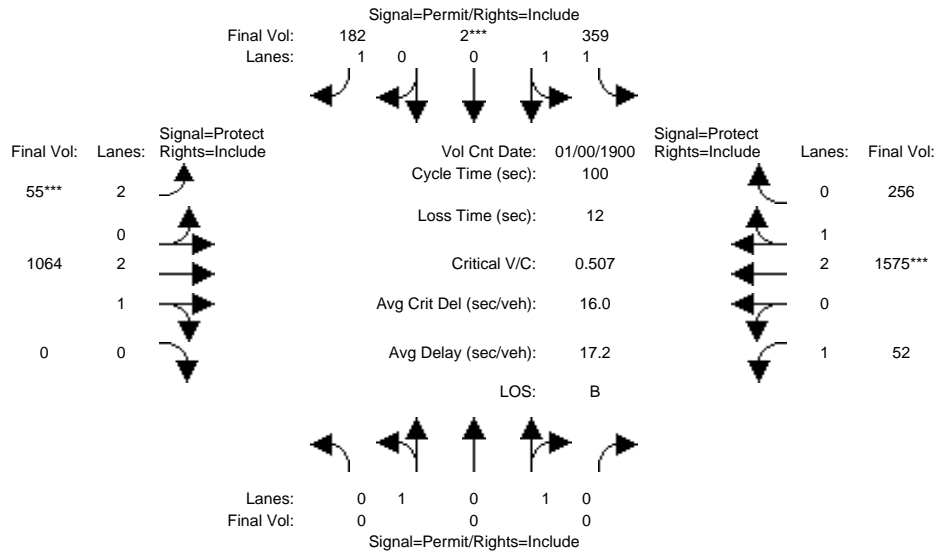

Approach:	North Bound			South Bound			East Bound			West Bound		
	L	T	R	L	T	R	L	T	R	L	T	R
Min. Green:	10	10	10	7	10	10	7	10	10	7	10	10
Y+R:	4.0	4.0	4.0	4.0	4.0	4.0	4.0	4.0	4.0	4.0	4.0	4.0
Volume Module: >> Count Date: 0 Jan 1900 << 12:00:00 AM												
Base Vol:	0	0	0	359	2	182	55	1064	0	52	1575	256
Growth Adj:	1.00	1.00	1.00	1.00	1.00	1.00	1.00	1.00	1.00	1.00	1.00	1.00
Initial Bse:	0	0	0	359	2	182	55	1064	0	52	1575	256
Added Vol:	0	0	0	0	0	0	0	0	0	0	0	0
PasserByVol:	0	0	0	0	0	0	0	0	0	0	0	0
Initial Fut:	0	0	0	359	2	182	55	1064	0	52	1575	256
User Adj:	1.00	1.00	1.00	1.00	1.00	1.00	1.00	1.00	1.00	1.00	1.00	1.00
PHF Adj:	1.00	1.00	1.00	1.00	1.00	1.00	1.00	1.00	1.00	1.00	1.00	1.00
PHF Volume:	0	0	0	359	2	182	55	1064	0	52	1575	256
Reduct Vol:	0	0	0	0	0	0	0	0	0	0	0	0
Reduced Vol:	0	0	0	359	2	182	55	1064	0	52	1575	256
PCE Adj:	1.00	1.00	1.00	1.00	1.00	1.00	1.00	1.00	1.00	1.00	1.00	1.00
MLF Adj:	1.00	1.00	1.00	1.00	1.00	1.00	1.00	1.00	1.00	1.00	1.00	1.00
FinalVolume:	0	0	0	359	2	182	55	1064	0	52	1575	256
Saturation Flow Module:												
Sat/Lane:	1900	1900	1900	1900	1900	1900	1900	1900	1900	1900	1900	1900
Adjustment:	0.92	1.00	0.92	0.93	0.95	0.92	0.83	0.98	0.92	0.92	0.99	0.95
Lanes:	0.00	0.00	2.00	1.99	0.01	1.00	2.00	3.00	0.00	1.00	2.57	0.43
Final Sat.:	0	0	3500	3530	20	1750	3150	5600	0	1750	4816	783
Capacity Analysis Module:												
Vol/Sat:	0.00	0.00	0.00	0.10	0.10	0.10	0.02	0.19	0.00	0.03	0.33	0.33
Crit Moves:				****			****			****		
Green Time:	0.0	0.0	0.0	19.2	19.2	19.2	7.0	50.3	0.0	18.5	61.8	61.8
Volume/Cap:	0.00	0.00	0.00	0.53	0.53	0.54	0.25	0.38	0.00	0.16	0.53	0.53
Delay/Veh:	0.0	0.0	0.0	37.1	37.1	38.2	44.6	15.4	0.0	34.4	11.0	11.0
User DelAdj:	1.00	1.00	1.00	1.00	1.00	1.00	1.00	1.00	1.00	1.00	1.00	1.00
AdjDel/Veh:	0.0	0.0	0.0	37.1	37.1	38.2	44.6	15.4	0.0	34.4	11.0	11.0
LOS by Move:	A	A	A	D+	D+	D+	D	B	A	C-	B+	B+
HCM2kAvgQ:	0	0	0	5	5	5	1	7	0	2	11	11

Note: Queue reported is the number of cars per lane.

San Antonio Village Phase III MTA
 SJ21-2068
 Existing AM

Level Of Service Computation Report
 2000 HCM Operations (Future Volume Alternative)
 Existing PP AM

Intersection #6: El Camino Real and Rengstorff Avenue

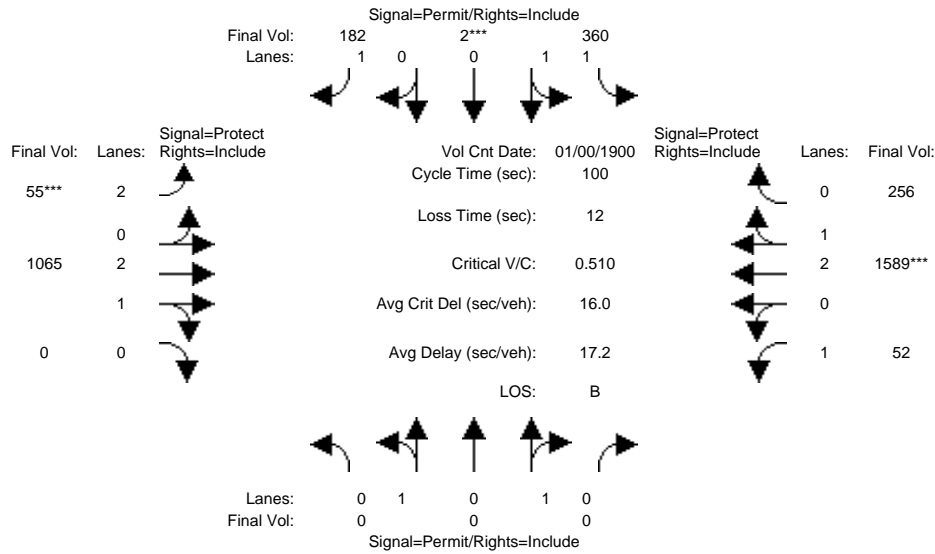

Approach:	North Bound			South Bound			East Bound			West Bound		
	L	T	R	L	T	R	L	T	R	L	T	R
Min. Green:	10	10	10	7	10	10	7	10	10	7	10	10
Y+R:	4.0	4.0	4.0	4.0	4.0	4.0	4.0	4.0	4.0	4.0	4.0	4.0
Volume Module: >> Count Date: 0 Jan 1900 << 12:00:00 AM												
Base Vol:	0	0	0	359	2	182	55	1064	0	52	1575	256
Growth Adj:	1.00	1.00	1.00	1.00	1.00	1.00	1.00	1.00	1.00	1.00	1.00	1.00
Initial Bse:	0	0	0	359	2	182	55	1064	0	52	1575	256
Added Vol:	0	0	0	1	0	0	0	1	0	0	14	0
PasserByVol:	0	0	0	0	0	0	0	0	0	0	0	0
Initial Fut:	0	0	0	360	2	182	55	1065	0	52	1589	256
User Adj:	1.00	1.00	1.00	1.00	1.00	1.00	1.00	1.00	1.00	1.00	1.00	1.00
PHF Adj:	1.00	1.00	1.00	1.00	1.00	1.00	1.00	1.00	1.00	1.00	1.00	1.00
PHF Volume:	0	0	0	360	2	182	55	1065	0	52	1589	256
Reduct Vol:	0	0	0	0	0	0	0	0	0	0	0	0
Reduced Vol:	0	0	0	360	2	182	55	1065	0	52	1589	256
PCE Adj:	1.00	1.00	1.00	1.00	1.00	1.00	1.00	1.00	1.00	1.00	1.00	1.00
MLF Adj:	1.00	1.00	1.00	1.00	1.00	1.00	1.00	1.00	1.00	1.00	1.00	1.00
FinalVolume:	0	0	0	360	2	182	55	1065	0	52	1589	256
Saturation Flow Module:												
Sat/Lane:	1900	1900	1900	1900	1900	1900	1900	1900	1900	1900	1900	1900
Adjustment:	0.92	1.00	0.92	0.93	0.95	0.92	0.83	0.98	0.92	0.92	0.99	0.95
Lanes:	0.00	0.00	2.00	1.99	0.01	1.00	2.00	3.00	0.00	1.00	2.57	0.43
Final Sat.:	0	0	3500	3530	20	1750	3150	5600	0	1750	4822	777
Capacity Analysis Module:												
Vol/Sat:	0.00	0.00	0.00	0.10	0.10	0.10	0.02	0.19	0.00	0.03	0.33	0.33
Crit Moves:				****			****			****		
Green Time:	0.0	0.0	0.0	19.1	19.1	19.1	7.0	50.3	0.0	18.5	61.9	61.9
Volume/Cap:	0.00	0.00	0.00	0.53	0.53	0.54	0.25	0.38	0.00	0.16	0.53	0.53
Delay/Veh:	0.0	0.0	0.0	37.2	37.2	38.3	44.6	15.3	0.0	34.4	11.0	11.0
User DelAdj:	1.00	1.00	1.00	1.00	1.00	1.00	1.00	1.00	1.00	1.00	1.00	1.00
AdjDel/Veh:	0.0	0.0	0.0	37.2	37.2	38.3	44.6	15.3	0.0	34.4	11.0	11.0
LOS by Move:	A	A	A	D+	D+	D+	D	B	A	C-	B+	B+
HCM2kAvgQ:	0	0	0	5	5	5	1	7	0	2	11	11

Note: Queue reported is the number of cars per lane.

San Antonio Village Phase III MTA
SJ21-2068
Existing AM

Level Of Service Computation Report
2000 HCM Operations (Future Volume Alternative)
Existing AM

Intersection #7: Fayette Drive and San Antonio Road

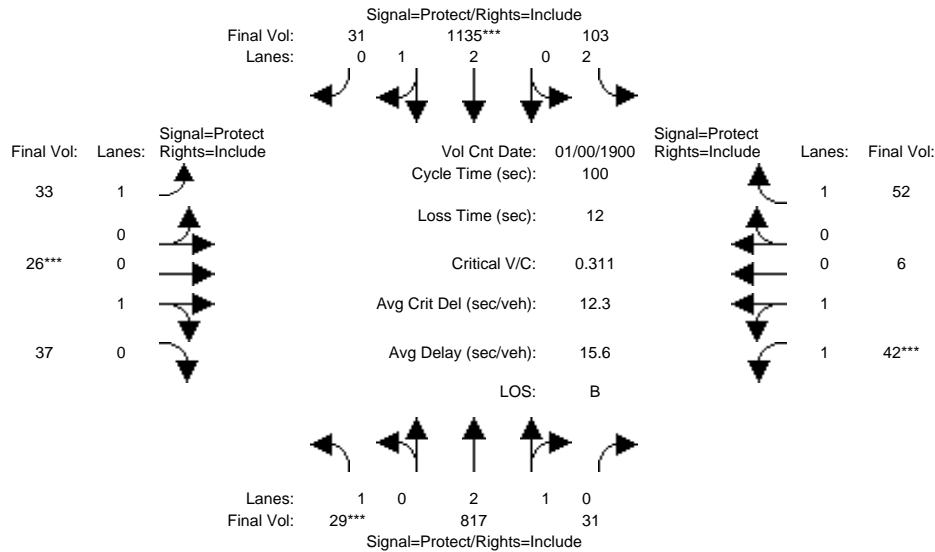

Approach:	North Bound			South Bound			East Bound			West Bound		
	L	T	R	L	T	R	L	T	R	L	T	R
Min. Green:	7	10	10	7	10	10	7	10	10	7	10	10
Y+R:	4.0	4.0	4.0	4.0	4.0	4.0	4.0	4.0	4.0	4.0	4.0	4.0

Volume Module:	>> Count Date: 0 Jan 1900 << 12:00:00 AM											
Base Vol:	29	817	31	103	1135	31	33	26	37	42	6	52
Growth Adj:	1.00	1.00	1.00	1.00	1.00	1.00	1.00	1.00	1.00	1.00	1.00	1.00
Initial Bse:	29	817	31	103	1135	31	33	26	37	42	6	52
Added Vol:	0	0	0	0	0	0	0	0	0	0	0	0
PasserByVol:	0	0	0	0	0	0	0	0	0	0	0	0
Initial Fut:	29	817	31	103	1135	31	33	26	37	42	6	52
User Adj:	1.00	1.00	1.00	1.00	1.00	1.00	1.00	1.00	1.00	1.00	1.00	1.00
PHF Adj:	1.00	1.00	1.00	1.00	1.00	1.00	1.00	1.00	1.00	1.00	1.00	1.00
PHF Volume:	29	817	31	103	1135	31	33	26	37	42	6	52
Reduct Vol:	0	0	0	0	0	0	0	0	0	0	0	0
Reduced Vol:	29	817	31	103	1135	31	33	26	37	42	6	52
PCE Adj:	1.00	1.00	1.00	1.00	1.00	1.00	1.00	1.00	1.00	1.00	1.00	1.00
MLF Adj:	1.00	1.00	1.00	1.00	1.00	1.00	1.00	1.00	1.00	1.00	1.00	1.00
Final Volume:	29	817	31	103	1135	31	33	26	37	42	6	52

Saturation Flow Module:												
Sat/Lane:	1900	1900	1900	1900	1900	1900	1900	1900	1900	1900	1900	1900
Adjustment:	0.92	0.98	0.95	0.83	0.98	0.95	0.92	0.95	0.95	0.93	0.95	0.92
Lanes:	1.00	2.89	0.11	2.00	2.92	0.08	1.00	0.41	0.59	1.75	0.25	1.00
Final Sat.:	1750	5395	205	3150	5451	149	1750	743	1057	3106	444	1750

Capacity Analysis Module:												
Vol/Sat:	0.02	0.15	0.15	0.03	0.21	0.21	0.02	0.04	0.04	0.01	0.01	0.03
Crit Moves:	****			****			****			****		
Green Time:	7.0	48.1	48.1	22.2	63.4	63.4	7.3	10.6	10.6	7.0	10.4	10.4
Volume/Cap:	0.24	0.31	0.31	0.15	0.33	0.33	0.26	0.33	0.33	0.19	0.13	0.29
Delay/Veh:	45.0	15.9	15.9	31.4	8.5	8.5	44.9	42.4	42.4	44.2	40.9	42.3
User DelAdj:	1.00	1.00	1.00	1.00	1.00	1.00	1.00	1.00	1.00	1.00	1.00	1.00
AdjDel/Veh:	45.0	15.9	15.9	31.4	8.5	8.5	44.9	42.4	42.4	44.2	40.9	42.3
LOS by Move:	D	B	B	C	A	A	D	D	D	D	D	D
HCM2kAvgQ:	1	5	5	1	5	5	1	2	2	1	1	2

Note: Queue reported is the number of cars per lane.

San Antonio Village Phase III MTA
 SJ21-2068
 Existing AM

Level Of Service Computation Report
 2000 HCM Operations (Future Volume Alternative)
 Existing PP AM

Intersection #7: Fayette Drive and San Antonio Road

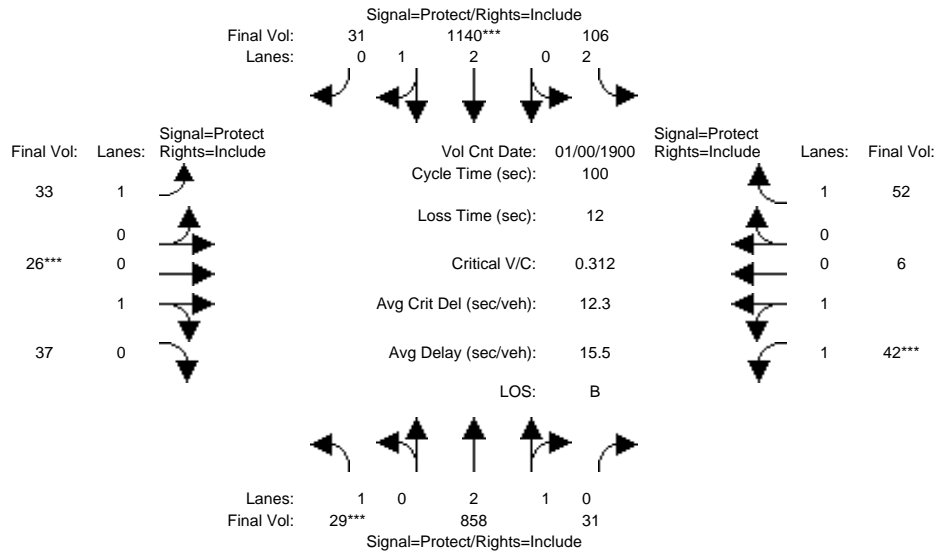

Approach:	North Bound			South Bound			East Bound			West Bound		
	L	T	R	L	T	R	L	T	R	L	T	R
Min. Green:	7	10	10	7	10	10	7	10	10	7	10	10
Y+R:	4.0	4.0	4.0	4.0	4.0	4.0	4.0	4.0	4.0	4.0	4.0	4.0
Volume Module: >> Count Date: 0 Jan 1900 << 12:00:00 AM												
Base Vol:	29	817	31	103	1135	31	33	26	37	42	6	52
Growth Adj:	1.00	1.00	1.00	1.00	1.00	1.00	1.00	1.00	1.00	1.00	1.00	1.00
Initial Bse:	29	817	31	103	1135	31	33	26	37	42	6	52
Added Vol:	0	41	0	3	5	0	0	0	0	0	0	0
PasserByVol:	0	0	0	0	0	0	0	0	0	0	0	0
Initial Fut:	29	858	31	106	1140	31	33	26	37	42	6	52
User Adj:	1.00	1.00	1.00	1.00	1.00	1.00	1.00	1.00	1.00	1.00	1.00	1.00
PHF Adj:	1.00	1.00	1.00	1.00	1.00	1.00	1.00	1.00	1.00	1.00	1.00	1.00
PHF Volume:	29	858	31	106	1140	31	33	26	37	42	6	52
Reduct Vol:	0	0	0	0	0	0	0	0	0	0	0	0
Reduced Vol:	29	858	31	106	1140	31	33	26	37	42	6	52
PCE Adj:	1.00	1.00	1.00	1.00	1.00	1.00	1.00	1.00	1.00	1.00	1.00	1.00
MLF Adj:	1.00	1.00	1.00	1.00	1.00	1.00	1.00	1.00	1.00	1.00	1.00	1.00
Final Volume:	29	858	31	106	1140	31	33	26	37	42	6	52
Saturation Flow Module:												
Sat/Lane:	1900	1900	1900	1900	1900	1900	1900	1900	1900	1900	1900	1900
Adjustment:	0.92	0.98	0.95	0.83	0.98	0.95	0.92	0.95	0.95	0.93	0.95	0.92
Lanes:	1.00	2.89	0.11	2.00	2.92	0.08	1.00	0.41	0.59	1.75	0.25	1.00
Final Sat.:	1750	5404	195	3150	5452	148	1750	743	1057	3106	444	1750
Capacity Analysis Module:												
Vol/Sat:	0.02	0.16	0.16	0.03	0.21	0.21	0.02	0.04	0.04	0.01	0.01	0.03
Crit Moves:	****			****			****			****		
Green Time:	7.0	48.9	48.9	21.5	63.4	63.4	7.3	10.6	10.6	7.0	10.4	10.4
Volume/Cap:	0.24	0.32	0.32	0.16	0.33	0.33	0.26	0.33	0.33	0.19	0.13	0.29
Delay/Veh:	45.0	15.6	15.6	32.0	8.5	8.5	44.9	42.4	42.4	44.2	40.9	42.3
User DelAdj:	1.00	1.00	1.00	1.00	1.00	1.00	1.00	1.00	1.00	1.00	1.00	1.00
AdjDel/Veh:	45.0	15.6	15.6	32.0	8.5	8.5	44.9	42.4	42.4	44.2	40.9	42.3
LOS by Move:	D	B	B	C	A	A	D	D	D	D	D	D
HCM2kAvgQ:	1	5	5	1	5	5	1	2	2	1	1	2

Note: Queue reported is the number of cars per lane.

San Antonio Village Phase III MTA
SJ21-2068
Existing AM

Level Of Service Computation Report
2000 HCM Unsignalized (Future Volume Alternative)
Existing AM

Intersection #8: Miller Avenue and San Antonio Road

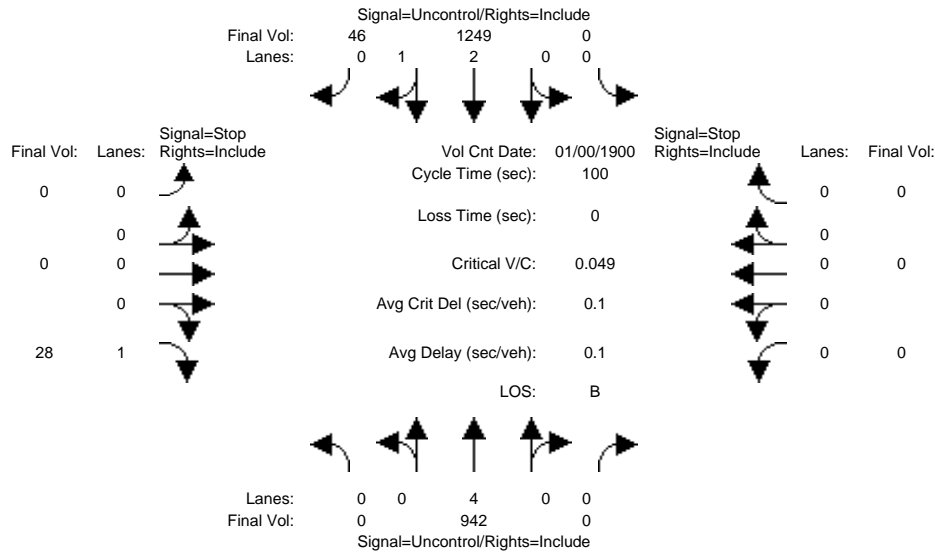

Approach:	North Bound			South Bound			East Bound			West Bound			
	L	T	R	L	T	R	L	T	R	L	T	R	
Volume Module: >> Count Date: 0 Jan 1900 << 12:00:00 AM	0	942	0	0	1249	46	0	0	28	0	0	0	
Base Vol:	0	942	0	0	1249	46	0	0	28	0	0	0	
Growth Adj:	1.00	1.00	1.00	1.00	1.00	1.00	1.00	1.00	1.00	1.00	1.00	1.00	
Initial Bse:	0	942	0	0	1249	46	0	0	28	0	0	0	
Added Vol:	0	0	0	0	0	0	0	0	0	0	0	0	
PasserByVol:	0	0	0	0	0	0	0	0	0	0	0	0	
Initial Fut:	0	942	0	0	1249	46	0	0	28	0	0	0	
User Adj:	1.00	1.00	1.00	1.00	1.00	1.00	1.00	1.00	1.00	1.00	1.00	1.00	
PHF Adj:	1.00	1.00	1.00	1.00	1.00	1.00	1.00	1.00	1.00	1.00	1.00	1.00	
PHF Volume:	0	942	0	0	1249	46	0	0	28	0	0	0	
Reduct Vol:	0	0	0	0	0	0	0	0	0	0	0	0	
Final Volume:	0	942	0	0	1249	46	0	0	28	0	0	0	
Critical Gap Module:	xxxxx	xxxx	xxxxx	xxxxx	xxxx	xxxxx	xxxxx	xxxx	6.9	xxxxx	xxxx	xxxxx	
FollowUpTim:	xxxxxx	xxxx	xxxxxx	xxxxxx	xxxx	xxxxxx	xxxxxx	xxxx	3.3	xxxxxx	xxxx	xxxxxx	
Capacity Module:	Cnflct Vol:	xxxx	xxxx	xxxxxx	xxxx	xxxx	xxxxxx	xxxx	xxxx	439	xxxx	xxxx	xxxxxx
Potent Cap.:	xxxx	xxxx	xxxxxx	xxxx	xxxx	xxxxxx	xxxx	xxxx	571	xxxx	xxxx	xxxxxx	
Move Cap.:	xxxx	xxxx	xxxxxx	xxxx	xxxx	xxxxxx	xxxx	xxxx	571	xxxx	xxxx	xxxxxx	
Volume/Cap:	xxxx	xxxx	xxxx	xxxx	xxxx	xxxx	xxxx	xxxx	0.05	xxxx	xxxx	xxxx	
Level Of Service Module:	2Way95thQ:	xxxx	xxxx	xxxxxx	xxxx	xxxx	xxxxxx	xxxx	xxxx	0.2	xxxx	xxxx	xxxxxx
Control Del:	xxxxxx	xxxx	xxxxxx	xxxxxx	xxxx	xxxxxx	xxxxxx	xxxx	11.6	xxxxxx	xxxx	xxxxxx	
LOS by Move:	*	*	*	*	*	*	*	*	B	*	*	*	
Movement:	LT - LTR - RT	LT - LTR - RT	LT - LTR - RT	LT - LTR - RT	LT - LTR - RT	LT - LTR - RT	LT - LTR - RT	LT - LTR - RT		LT - LTR - RT	LT - LTR - RT	LT - LTR - RT	
Shared Cap.:	xxxx	xxxx	xxxxxx	xxxx	xxxx	xxxxxx	xxxx	xxxx	xxxxxx	xxxx	xxxx	xxxxxx	
Shared Queue:	xxxxxx	xxxx	xxxxxx	xxxxxx	xxxx	xxxxxx	xxxxxx	xxxx	xxxxxx	xxxxxx	xxxx	xxxxxx	
Shrd ConDel:	xxxxxx	xxxx	xxxxxx	xxxxxx	xxxx	xxxxxx	xxxxxx	xxxx	xxxxxx	xxxxxx	xxxx	xxxxxx	
Shared LOS:	*	*	*	*	*	*	*	*	*	*	*	*	
ApproachDel:	xxxxxx		xxxxxx			11.6		xxxxxx					
ApproachLOS:	*		*			B		*					

Note: Queue reported is the number of cars per lane.

San Antonio Village Phase III MTA
SJ21-2068
Existing AM

Level Of Service Computation Report
2000 HCM Unsignalized (Future Volume Alternative)
Existing PP AM

Intersection #8: Miller Avenue and San Antonio Road

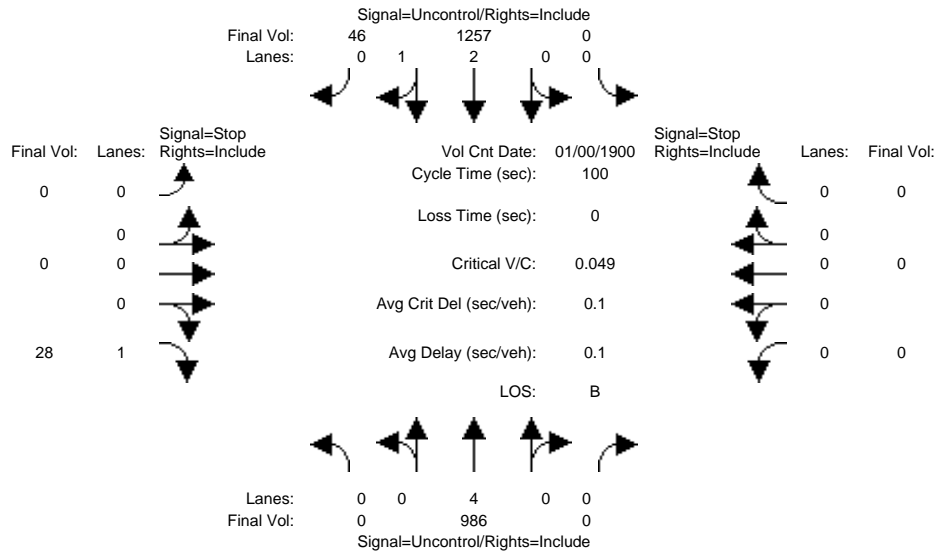

Approach:	North Bound			South Bound			East Bound			West Bound		
	L	T	R	L	T	R	L	T	R	L	T	R
Volume Module: >> Count Date: 0 Jan 1900 << 12:00:00 AM												
Base Vol:	0	942	0	0	1249	46	0	0	28	0	0	0
Growth Adj:	1.00	1.00	1.00	1.00	1.00	1.00	1.00	1.00	1.00	1.00	1.00	1.00
Initial Bse:	0	942	0	0	1249	46	0	0	28	0	0	0
Added Vol:	0	44	0	0	8	0	0	0	0	0	0	0
PasserByVol:	0	0	0	0	0	0	0	0	0	0	0	0
Initial Fut:	0	986	0	0	1257	46	0	0	28	0	0	0
User Adj:	1.00	1.00	1.00	1.00	1.00	1.00	1.00	1.00	1.00	1.00	1.00	1.00
PHF Adj:	1.00	1.00	1.00	1.00	1.00	1.00	1.00	1.00	1.00	1.00	1.00	1.00
PHF Volume:	0	986	0	0	1257	46	0	0	28	0	0	0
Reduct Vol:	0	0	0	0	0	0	0	0	0	0	0	0
FinalVolume:	0	986	0	0	1257	46	0	0	28	0	0	0
Critical Gap Module:												
Critical Gp:	xxxxx	xxxx	xxxxx	xxxxx	xxxx	xxxxx	xxxxx	xxxx	6.9	xxxxx	xxxx	xxxxx
FollowUpTim:	xxxxxx	xxxx	xxxxxx	xxxxxx	xxxx	xxxxxx	xxxxxx	xxxx	3.3	xxxxxx	xxxx	xxxxxx
Capacity Module:												
Cnflct Vol:	xxxx	xxxx	xxxxxx	xxxx	xxxx	xxxxxx	xxxx	xxxx	442	xxxx	xxxx	xxxxxx
Potent Cap.:	xxxx	xxxx	xxxxxx	xxxx	xxxx	xxxxxx	xxxx	xxxx	569	xxxx	xxxx	xxxxxx
Move Cap.:	xxxx	xxxx	xxxxxx	xxxx	xxxx	xxxxxx	xxxx	xxxx	569	xxxx	xxxx	xxxxxx
Volume/Cap:	xxxx	xxxx	xxxx	xxxx	xxxx	xxxx	xxxx	xxxx	0.05	xxxx	xxxx	xxxx
Level Of Service Module:												
2Way95thQ:	xxxx	xxxx	xxxxxx	xxxx	xxxx	xxxxxx	xxxx	xxxx	0.2	xxxx	xxxx	xxxxxx
Control Del:	xxxxxx	xxxx	xxxxxx	xxxxxx	xxxx	xxxxxx	xxxxxx	xxxx	11.7	xxxxxx	xxxx	xxxxxx
LOS by Move:	*	*	*	*	*	*	*	*	B	*	*	*
Movement:	LT	LTR	RT	LT	LTR	RT	LT	LTR	RT	LT	LTR	RT
Shared Cap.:	xxxx	xxxx	xxxxxx	xxxx	xxxx	xxxxxx	xxxx	xxxx	xxxxxx	xxxx	xxxx	xxxxxx
SharedQueue:	xxxxxx	xxxx	xxxxxx	xxxxxx	xxxx	xxxxxx	xxxxxx	xxxx	xxxxxx	xxxxxx	xxxx	xxxxxx
Shrd ConDel:	xxxxxx	xxxx	xxxxxx	xxxxxx	xxxx	xxxxxx	xxxxxx	xxxx	xxxxxx	xxxxxx	xxxx	xxxxxx
Shared LOS:	*	*	*	*	*	*	*	*	*	*	*	*
ApproachDel:	xxxxxx			xxxxxx					11.7	xxxxxx		
ApproachLOS:	*			*					B	*		

Note: Queue reported is the number of cars per lane.

San Antonio Village Phase III MTA
 SJ21-2068
 Existing AM

Level Of Service Computation Report
 2000 HCM Operations (Future Volume Alternative)
 Existing AM

Intersection #9: Nita Avenue and San Antonio Road

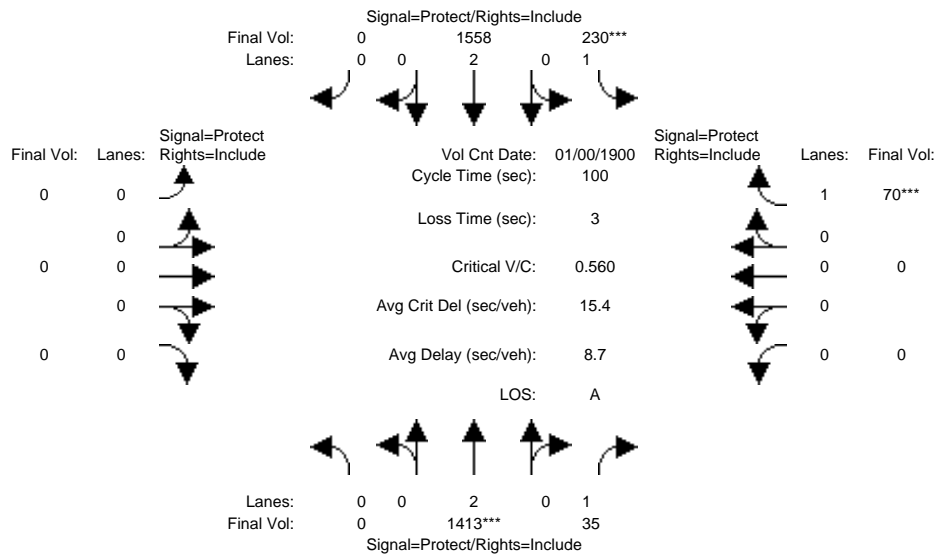

Approach:	North Bound			South Bound			East Bound			West Bound		
	L	T	R	L	T	R	L	T	R	L	T	R
Min. Green:	0	10	10	7	10	0	0	0	0	0	0	10
Y+R:	4.0	4.0	4.0	4.0	4.0	4.0	4.0	4.0	4.0	4.0	4.0	4.0

Volume Module:	>>	Count	Date:	0 Jan 1900	<<	12:00:00 AM						
Base Vol:	0	1413	35	230	1558	0	0	0	0	0	0	70
Growth Adj:	1.00	1.00	1.00	1.00	1.00	1.00	1.00	1.00	1.00	1.00	1.00	1.00
Initial Bse:	0	1413	35	230	1558	0	0	0	0	0	0	70
Added Vol:	0	0	0	0	0	0	0	0	0	0	0	0
PasserByVol:	0	0	0	0	0	0	0	0	0	0	0	0
Initial Fut:	0	1413	35	230	1558	0	0	0	0	0	0	70
User Adj:	1.00	1.00	1.00	1.00	1.00	1.00	1.00	1.00	1.00	1.00	1.00	1.00
PHF Adj:	1.00	1.00	1.00	1.00	1.00	1.00	1.00	1.00	1.00	1.00	1.00	1.00
PHF Volume:	0	1413	35	230	1558	0	0	0	0	0	0	70
Reduct Vol:	0	0	0	0	0	0	0	0	0	0	0	0
Reduced Vol:	0	1413	35	230	1558	0	0	0	0	0	0	70
PCE Adj:	1.00	1.00	1.00	1.00	1.00	1.00	1.00	1.00	1.00	1.00	1.00	1.00
MLF Adj:	1.00	1.00	1.00	1.00	1.00	1.00	1.00	1.00	1.00	1.00	1.00	1.00
Final Volume:	0	1413	35	230	1558	0	0	0	0	0	0	70

Saturation Flow Module:												
Sat/Lane:	1900	1900	1900	1900	1900	1900	1900	1900	1900	1900	1900	1900
Adjustment:	0.92	1.00	0.92	0.92	1.00	0.92	0.92	1.00	0.92	0.92	1.00	0.92
Lanes:	0.00	2.00	1.00	1.00	2.00	0.00	0.00	0.00	0.00	0.00	0.00	1.00
Final Sat.:	0	3800	1750	1750	3800	0	0	0	0	0	0	1750

Capacity Analysis Module:												
Vol/Sat:	0.00	0.37	0.02	0.13	0.41	0.00	0.00	0.00	0.00	0.00	0.00	0.04
Crit Moves:		****		****								****
Green Time:	0.0	64.3	64.3	22.7	87.0	0.0	0.0	0.0	0.0	0.0	0.0	10.0
Volume/Cap:	0.00	0.58	0.03	0.58	0.47	0.00	0.00	0.00	0.00	0.00	0.00	0.40
Delay/Veh:	0.0	10.5	6.5	36.5	1.5	0.0	0.0	0.0	0.0	0.0	0.0	43.7
User DelAdj:	1.00	1.00	1.00	1.00	1.00	1.00	1.00	1.00	1.00	1.00	1.00	1.00
AdjDel/Veh:	0.0	10.5	6.5	36.5	1.5	0.0	0.0	0.0	0.0	0.0	0.0	43.7
LOS by Move:	A	B+	A	D+	A	A	A	A	A	A	A	D
HCM2kAvgQ:	0	12	0	6	5	0	0	0	0	0	0	3

Note: Queue reported is the number of cars per lane.

San Antonio Village Phase III MTA
 SJ21-2068
 Existing AM

Level Of Service Computation Report
 2000 HCM Operations (Future Volume Alternative)
 Existing PP AM

Intersection #9: Nita Avenue and San Antonio Road

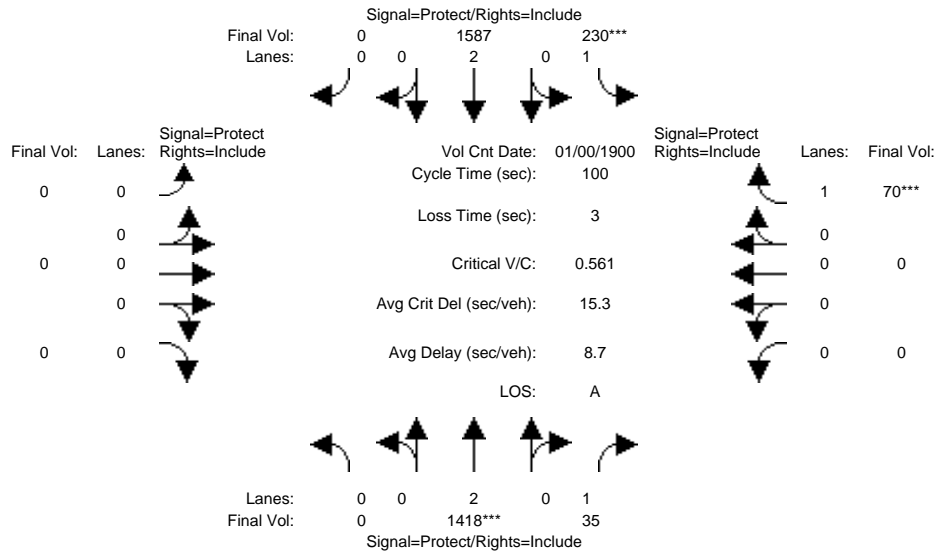

Approach:	North Bound			South Bound			East Bound			West Bound		
	L	T	R	L	T	R	L	T	R	L	T	R
Min. Green:	0	10	10	7	10	0	0	0	0	0	0	10
Y+R:	4.0	4.0	4.0	4.0	4.0	4.0	4.0	4.0	4.0	4.0	4.0	4.0
Volume Module: >> Count Date: 0 Jan 1900 << 12:00:00 AM												
Base Vol:	0	1413	35	230	1558	0	0	0	0	0	0	70
Growth Adj:	1.00	1.00	1.00	1.00	1.00	1.00	1.00	1.00	1.00	1.00	1.00	1.00
Initial Bse:	0	1413	35	230	1558	0	0	0	0	0	0	70
Added Vol:	0	5	0	0	29	0	0	0	0	0	0	0
PasserByVol:	0	0	0	0	0	0	0	0	0	0	0	0
Initial Fut:	0	1418	35	230	1587	0	0	0	0	0	0	70
User Adj:	1.00	1.00	1.00	1.00	1.00	1.00	1.00	1.00	1.00	1.00	1.00	1.00
PHF Adj:	1.00	1.00	1.00	1.00	1.00	1.00	1.00	1.00	1.00	1.00	1.00	1.00
PHF Volume:	0	1418	35	230	1587	0	0	0	0	0	0	70
Reduct Vol:	0	0	0	0	0	0	0	0	0	0	0	0
Reduced Vol:	0	1418	35	230	1587	0	0	0	0	0	0	70
PCE Adj:	1.00	1.00	1.00	1.00	1.00	1.00	1.00	1.00	1.00	1.00	1.00	1.00
MLF Adj:	1.00	1.00	1.00	1.00	1.00	1.00	1.00	1.00	1.00	1.00	1.00	1.00
FinalVolume:	0	1418	35	230	1587	0	0	0	0	0	0	70
Saturation Flow Module:												
Sat/Lane:	1900	1900	1900	1900	1900	1900	1900	1900	1900	1900	1900	1900
Adjustment:	0.92	1.00	0.92	0.92	1.00	0.92	0.92	1.00	0.92	0.92	1.00	0.92
Lanes:	0.00	2.00	1.00	1.00	2.00	0.00	0.00	0.00	0.00	0.00	0.00	1.00
Final Sat.:	0	3800	1750	1750	3800	0	0	0	0	0	0	1750
Capacity Analysis Module:												
Vol/Sat:	0.00	0.37	0.02	0.13	0.42	0.00	0.00	0.00	0.00	0.00	0.00	0.04
Crit Moves:	****		****			****		****			****	
Green Time:	0.0	64.3	64.3	22.7	87.0	0.0	0.0	0.0	0.0	0.0	0.0	10.0
Volume/Cap:	0.00	0.58	0.03	0.58	0.48	0.00	0.00	0.00	0.00	0.00	0.00	0.40
Delay/Veh:	0.0	10.5	6.5	36.6	1.6	0.0	0.0	0.0	0.0	0.0	0.0	43.7
User DelAdj:	1.00	1.00	1.00	1.00	1.00	1.00	1.00	1.00	1.00	1.00	1.00	1.00
AdjDel/Veh:	0.0	10.5	6.5	36.6	1.6	0.0	0.0	0.0	0.0	0.0	0.0	43.7
LOS by Move:	A	B+	A	D+	A	A	A	A	A	A	A	D
HCM2kAvgQ:	0	12	0	6	5	0	0	0	0	0	0	3

Note: Queue reported is the number of cars per lane.

San Antonio Village Phase III MTA
 SJ21-2068
 Existing AM

Level Of Service Computation Report
 2000 HCM Operations (Future Volume Alternative)
 Existing AM

Intersection #10: California Street and San Antonio Road

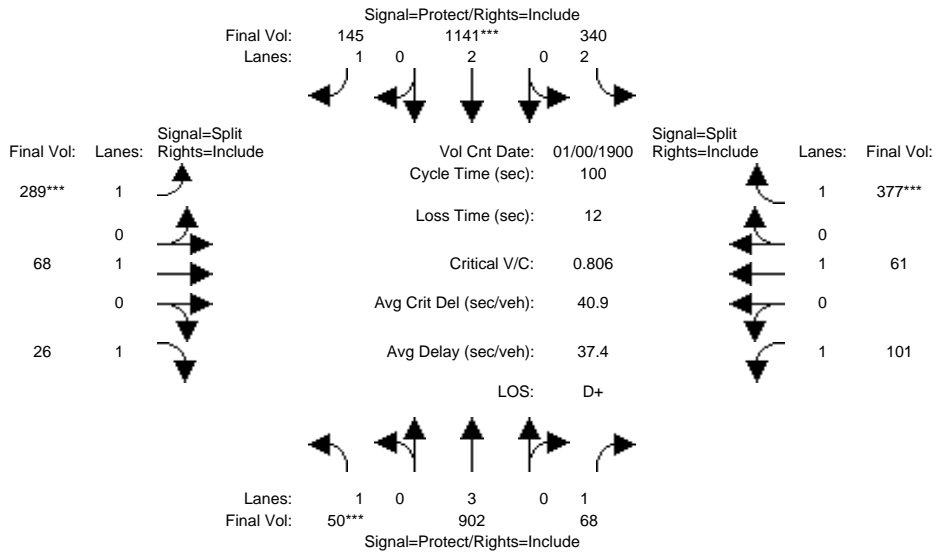

Approach:	North Bound			South Bound			East Bound			West Bound		
	L	T	R	L	T	R	L	T	R	L	T	R
Min. Green:	7	10	10	7	10	10	10	10	10	10	10	10
Y+R:	4.0	4.0	4.0	4.0	4.0	4.0	4.0	4.0	4.0	4.0	4.0	4.0
Volume Module: >> Count Date: 0 Jan 1900 << 12:00:00 AM												
Base Vol:	50	902	68	340	1141	145	289	68	26	101	61	377
Growth Adj:	1.00	1.00	1.00	1.00	1.00	1.00	1.00	1.00	1.00	1.00	1.00	1.00
Initial Bse:	50	902	68	340	1141	145	289	68	26	101	61	377
Added Vol:	0	0	0	0	0	0	0	0	0	0	0	0
PasserByVol:	0	0	0	0	0	0	0	0	0	0	0	0
Initial Fut:	50	902	68	340	1141	145	289	68	26	101	61	377
User Adj:	1.00	1.00	1.00	1.00	1.00	1.00	1.00	1.00	1.00	1.00	1.00	1.00
PHF Adj:	1.00	1.00	1.00	1.00	1.00	1.00	1.00	1.00	1.00	1.00	1.00	1.00
PHF Volume:	50	902	68	340	1141	145	289	68	26	101	61	377
Reduct Vol:	0	0	0	0	0	0	0	0	0	0	0	0
Reduced Vol:	50	902	68	340	1141	145	289	68	26	101	61	377
PCE Adj:	1.00	1.00	1.00	1.00	1.00	1.00	1.00	1.00	1.00	1.00	1.00	1.00
MLF Adj:	1.00	1.00	1.00	1.00	1.00	1.00	1.00	1.00	1.00	1.00	1.00	1.00
FinalVolume:	50	902	68	340	1141	145	289	68	26	101	61	377
Saturation Flow Module:												
Sat/Lane:	1900	1900	1900	1900	1900	1900	1900	1900	1900	1900	1900	1900
Adjustment:	0.92	1.00	0.92	0.83	1.00	0.92	0.92	1.00	0.92	0.92	1.00	0.92
Lanes:	1.00	3.00	1.00	2.00	2.00	1.00	1.00	1.00	1.00	1.00	1.00	1.00
Final Sat.:	1750	5700	1750	3150	3800	1750	1750	1900	1750	1750	1900	1750
Capacity Analysis Module:												
Vol/Sat:	0.03	0.16	0.04	0.11	0.30	0.08	0.17	0.04	0.01	0.06	0.03	0.22
Crit Moves:	****				****		****					****
Green Time:	7.0	25.4	25.4	17.3	35.7	35.7	19.6	19.6	19.6	25.6	25.6	25.6
Volume/Cap:	0.41	0.62	0.15	0.62	0.84	0.23	0.84	0.18	0.08	0.23	0.13	0.84
Delay/Veh:	46.7	33.9	29.1	40.6	34.4	22.7	55.3	33.7	32.9	29.6	28.7	48.5
User DelAdj:	1.00	1.00	1.00	1.00	1.00	1.00	1.00	1.00	1.00	1.00	1.00	1.00
AdjDel/Veh:	46.7	33.9	29.1	40.6	34.4	22.7	55.3	33.7	32.9	29.6	28.7	48.5
LOS by Move:	D	C-	C	D	C-	C+	E+	C-	C-	C	C	D
HCM2kAvgQ:	2	8	2	6	17	3	12	2	1	3	1	13

Note: Queue reported is the number of cars per lane.

San Antonio Village Phase III MTA
 SJ21-2068
 Existing AM

Level Of Service Computation Report
 2000 HCM Operations (Future Volume Alternative)
 Existing PP AM

Intersection #10: California Street and San Antonio Road

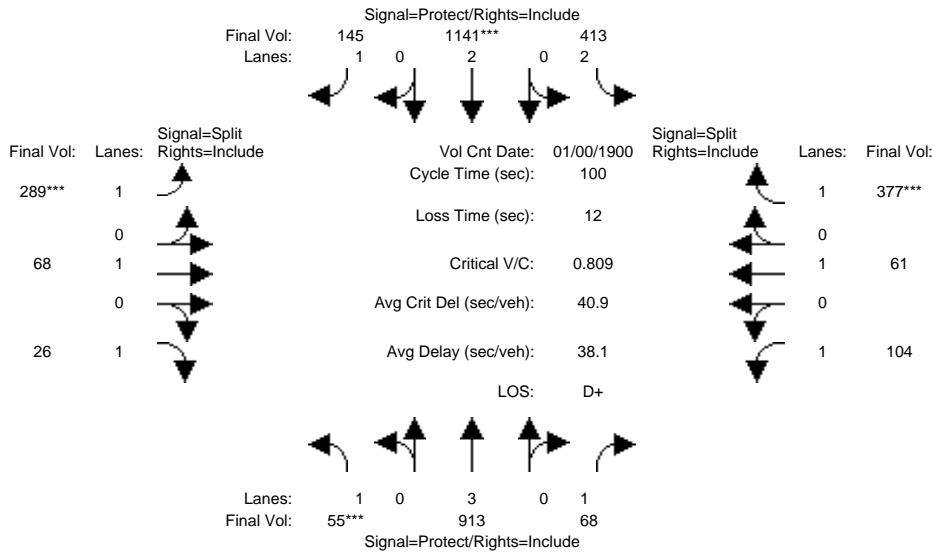

Approach:	North Bound			South Bound			East Bound			West Bound		
	L	T	R	L	T	R	L	T	R	L	T	R
Min. Green:	7	10	10	7	10	10	10	10	10	10	10	10
Y+R:	4.0	4.0	4.0	4.0	4.0	4.0	4.0	4.0	4.0	4.0	4.0	4.0
Volume Module: >> Count Date: 0 Jan 1900 << 12:00:00 AM												
Base Vol:	50	902	68	340	1141	145	289	68	26	101	61	377
Growth Adj:	1.00	1.00	1.00	1.00	1.00	1.00	1.00	1.00	1.00	1.00	1.00	1.00
Initial Bse:	50	902	68	340	1141	145	289	68	26	101	61	377
Added Vol:	5	11	0	73	0	0	0	0	0	3	0	0
PasserByVol:	0	0	0	0	0	0	0	0	0	0	0	0
Initial Fut:	55	913	68	413	1141	145	289	68	26	104	61	377
User Adj:	1.00	1.00	1.00	1.00	1.00	1.00	1.00	1.00	1.00	1.00	1.00	1.00
PHF Adj:	1.00	1.00	1.00	1.00	1.00	1.00	1.00	1.00	1.00	1.00	1.00	1.00
PHF Volume:	55	913	68	413	1141	145	289	68	26	104	61	377
Reduct Vol:	0	0	0	0	0	0	0	0	0	0	0	0
Reduced Vol:	55	913	68	413	1141	145	289	68	26	104	61	377
PCE Adj:	1.00	1.00	1.00	1.00	1.00	1.00	1.00	1.00	1.00	1.00	1.00	1.00
MLF Adj:	1.00	1.00	1.00	1.00	1.00	1.00	1.00	1.00	1.00	1.00	1.00	1.00
FinalVolume:	55	913	68	413	1141	145	289	68	26	104	61	377
Saturation Flow Module:												
Sat/Lane:	1900	1900	1900	1900	1900	1900	1900	1900	1900	1900	1900	1900
Adjustment:	0.92	1.00	0.92	0.83	1.00	0.92	0.92	1.00	0.92	0.92	1.00	0.92
Lanes:	1.00	3.00	1.00	2.00	2.00	1.00	1.00	1.00	1.00	1.00	1.00	1.00
Final Sat.:	1750	5700	1750	3150	3800	1750	1750	1900	1750	1750	1900	1750
Capacity Analysis Module:												
Vol/Sat:	0.03	0.16	0.04	0.13	0.30	0.08	0.17	0.04	0.01	0.06	0.03	0.22
Crit Moves:	****			****			****					****
Green Time:	7.0	23.5	23.5	19.2	35.7	35.7	19.6	19.6	19.6	25.6	25.6	25.6
Volume/Cap:	0.45	0.68	0.17	0.68	0.84	0.23	0.84	0.18	0.08	0.23	0.13	0.84
Delay/Veh:	47.3	36.3	30.6	40.7	34.4	22.7	55.3	33.7	32.9	29.7	28.7	48.5
User DelAdj:	1.00	1.00	1.00	1.00	1.00	1.00	1.00	1.00	1.00	1.00	1.00	1.00
AdjDel/Veh:	47.3	36.3	30.6	40.7	34.4	22.7	55.3	33.7	32.9	29.7	28.7	48.5
LOS by Move:	D	D+	C	D	C-	C+	E+	C-	C-	C	C	D
HCM2kAvgQ:	2	9	2	7	17	3	12	2	1	3	1	13

Note: Queue reported is the number of cars per lane.

San Antonio Village Phase III MTA
 SJ21-2068
 Existing AM

Level Of Service Computation Report
 2000 HCM Operations (Future Volume Alternative)
 Existing AM

Intersection #11: California Street and Pacchetti Way

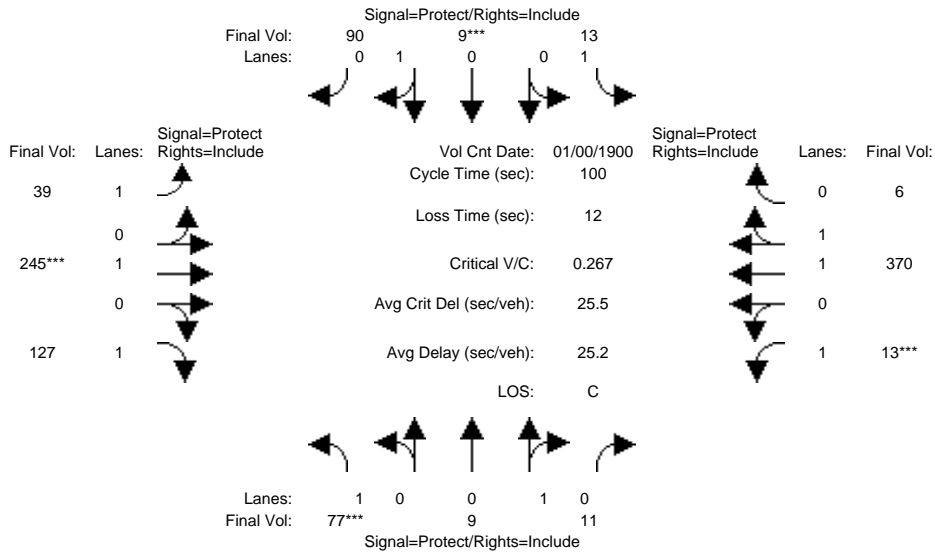

Approach:	North Bound			South Bound			East Bound			West Bound		
Movement:	L	T	R	L	T	R	L	T	R	L	T	R
Min. Green:	7	10	10	7	10	10	7	10	10	7	10	10
Y+R:	4.0	4.0	4.0	4.0	4.0	4.0	4.0	4.0	4.0	4.0	4.0	4.0
Volume Module: >> Count Date: 0 Jan 1900 << 12:00:00 AM												
Base Vol:	77	9	11	13	9	90	39	245	127	13	370	6
Growth Adj:	1.00	1.00	1.00	1.00	1.00	1.00	1.00	1.00	1.00	1.00	1.00	1.00
Initial Bse:	77	9	11	13	9	90	39	245	127	13	370	6
Added Vol:	0	0	0	0	0	0	0	0	0	0	0	0
PasserByVol:	0	0	0	0	0	0	0	0	0	0	0	0
Initial Fut:	77	9	11	13	9	90	39	245	127	13	370	6
User Adj:	1.00	1.00	1.00	1.00	1.00	1.00	1.00	1.00	1.00	1.00	1.00	1.00
PHF Adj:	1.00	1.00	1.00	1.00	1.00	1.00	1.00	1.00	1.00	1.00	1.00	1.00
PHF Volume:	77	9	11	13	9	90	39	245	127	13	370	6
Reduct Vol:	0	0	0	0	0	0	0	0	0	0	0	0
Reduced Vol:	77	9	11	13	9	90	39	245	127	13	370	6
PCE Adj:	1.00	1.00	1.00	1.00	1.00	1.00	1.00	1.00	1.00	1.00	1.00	1.00
MLF Adj:	1.00	1.00	1.00	1.00	1.00	1.00	1.00	1.00	1.00	1.00	1.00	1.00
FinalVolume:	77	9	11	13	9	90	39	245	127	13	370	6
Saturation Flow Module:												
Sat/Lane:	1900	1900	1900	1900	1900	1900	1900	1900	1900	1900	1900	1900
Adjustment:	0.92	0.95	0.95	0.92	0.95	0.95	0.92	1.00	0.92	0.92	0.97	0.95
Lanes:	1.00	0.45	0.55	1.00	0.09	0.91	1.00	1.00	1.00	1.00	1.97	0.03
Final Sat.:	1750	810	990	1750	164	1636	1750	1900	1750	1750	3641	59
Capacity Analysis Module:												
Vol/Sat:	0.04	0.01	0.01	0.01	0.06	0.06	0.02	0.13	0.07	0.01	0.10	0.10
Crit Moves:	****			****			****			****		
Green Time:	15.6	20.7	20.7	14.5	19.5	19.5	21.5	45.8	45.8	7.0	31.3	31.3
Volume/Cap:	0.28	0.05	0.05	0.05	0.28	0.28	0.10	0.28	0.16	0.11	0.32	0.32
Delay/Veh:	37.8	31.9	31.9	36.9	34.7	34.7	31.6	17.0	15.9	44.0	26.5	26.5
User DelAdj:	1.00	1.00	1.00	1.00	1.00	1.00	1.00	1.00	1.00	1.00	1.00	1.00
AdjDel/Veh:	37.8	31.9	31.9	36.9	34.7	34.7	31.6	17.0	15.9	44.0	26.5	26.5
LOS by Move:	D+	C	C	D+	C-	C-	C	B	B	D	C	C
HCM2kAvgQ:	2	1	1	0	3	3	1	4	2	0	4	4

Note: Queue reported is the number of cars per lane.

San Antonio Village Phase III MTA
 SJ21-2068
 Existing AM

Level Of Service Computation Report
 2000 HCM Operations (Future Volume Alternative)
 Existing PP AM

Intersection #11: California Street and Pacchetti Way

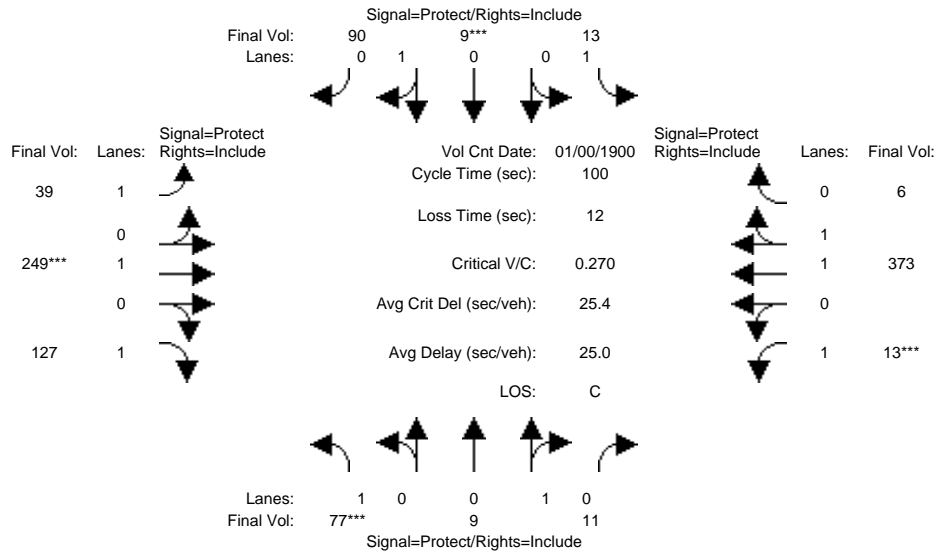

Approach:	North Bound			South Bound			East Bound			West Bound		
Movement:	L	T	R	L	T	R	L	T	R	L	T	R
Min. Green:	7	10	10	7	10	10	7	10	10	7	10	10
Y+R:	4.0	4.0	4.0	4.0	4.0	4.0	4.0	4.0	4.0	4.0	4.0	4.0
Volume Module: >> Count Date: 0 Jan 1900 << 12:00:00 AM												
Base Vol:	77	9	11	13	9	90	39	245	127	13	370	6
Growth Adj:	1.00	1.00	1.00	1.00	1.00	1.00	1.00	1.00	1.00	1.00	1.00	1.00
Initial Bse:	77	9	11	13	9	90	39	245	127	13	370	6
Added Vol:	0	0	0	0	0	0	0	4	0	0	3	0
PasserByVol:	0	0	0	0	0	0	0	0	0	0	0	0
Initial Fut:	77	9	11	13	9	90	39	249	127	13	373	6
User Adj:	1.00	1.00	1.00	1.00	1.00	1.00	1.00	1.00	1.00	1.00	1.00	1.00
PHF Adj:	1.00	1.00	1.00	1.00	1.00	1.00	1.00	1.00	1.00	1.00	1.00	1.00
PHF Volume:	77	9	11	13	9	90	39	249	127	13	373	6
Reduct Vol:	0	0	0	0	0	0	0	0	0	0	0	0
Reduced Vol:	77	9	11	13	9	90	39	249	127	13	373	6
PCE Adj:	1.00	1.00	1.00	1.00	1.00	1.00	1.00	1.00	1.00	1.00	1.00	1.00
MLF Adj:	1.00	1.00	1.00	1.00	1.00	1.00	1.00	1.00	1.00	1.00	1.00	1.00
FinalVolume:	77	9	11	13	9	90	39	249	127	13	373	6
Saturation Flow Module:												
Sat/Lane:	1900	1900	1900	1900	1900	1900	1900	1900	1900	1900	1900	1900
Adjustment:	0.92	0.95	0.95	0.92	0.95	0.95	0.92	1.00	0.92	0.92	0.97	0.95
Lanes:	1.00	0.45	0.55	1.00	0.09	0.91	1.00	1.00	1.00	1.00	1.97	0.03
Final Sat.:	1750	810	990	1750	164	1636	1750	1900	1750	1750	3641	59
Capacity Analysis Module:												
Vol/Sat:	0.04	0.01	0.01	0.01	0.06	0.06	0.02	0.13	0.07	0.01	0.10	0.10
Crit Moves:	****			****			****			****		
Green Time:	15.5	20.5	20.5	14.4	19.4	19.4	21.6	46.1	46.1	7.0	31.6	31.6
Volume/Cap:	0.28	0.05	0.05	0.05	0.28	0.28	0.10	0.28	0.16	0.11	0.32	0.32
Delay/Veh:	37.9	32.0	32.0	37.0	34.9	34.9	31.6	16.9	15.7	44.0	26.2	26.2
User DelAdj:	1.00	1.00	1.00	1.00	1.00	1.00	1.00	1.00	1.00	1.00	1.00	1.00
AdjDel/Veh:	37.9	32.0	32.0	37.0	34.9	34.9	31.6	16.9	15.7	44.0	26.2	26.2
LOS by Move:	D+	C-	C-	D+	C-	C-	C	B	B	D	C	C
HCM2kAvgQ:	2	1	1	0	3	3	1	5	2	0	4	4

Note: Queue reported is the number of cars per lane.

San Antonio Village Phase III MTA
 SJ21-2068
 Existing AM

Level Of Service Computation Report
 2000 HCM Operations (Future Volume Alternative)
 Existing AM

Intersection #12: California Street and Showers Drive

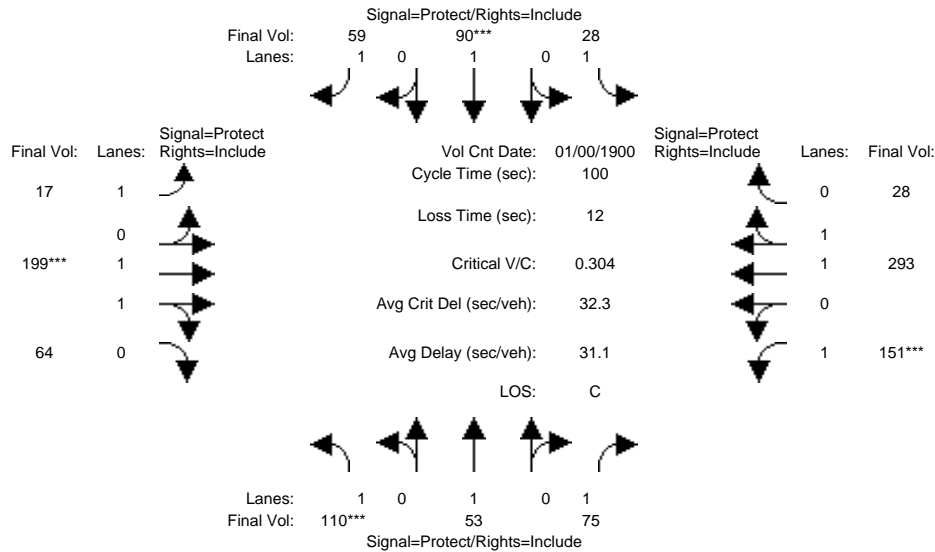

Approach:	North Bound			South Bound			East Bound			West Bound		
	L	T	R	L	T	R	L	T	R	L	T	R
Min. Green:	7	10	10	7	10	10	7	10	10	7	10	10
Y+R:	4.0	4.0	4.0	4.0	4.0	4.0	4.0	4.0	4.0	4.0	4.0	4.0
Volume Module: >> Count Date: 0 Jan 1900 << 12:00:00 AM												
Base Vol:	110	53	75	28	90	59	17	199	64	151	293	28
Growth Adj:	1.00	1.00	1.00	1.00	1.00	1.00	1.00	1.00	1.00	1.00	1.00	1.00
Initial Bse:	110	53	75	28	90	59	17	199	64	151	293	28
Added Vol:	0	0	0	0	0	0	0	0	0	0	0	0
PasserByVol:	0	0	0	0	0	0	0	0	0	0	0	0
Initial Fut:	110	53	75	28	90	59	17	199	64	151	293	28
User Adj:	1.00	1.00	1.00	1.00	1.00	1.00	1.00	1.00	1.00	1.00	1.00	1.00
PHF Adj:	1.00	1.00	1.00	1.00	1.00	1.00	1.00	1.00	1.00	1.00	1.00	1.00
PHF Volume:	110	53	75	28	90	59	17	199	64	151	293	28
Reduct Vol:	0	0	0	0	0	0	0	0	0	0	0	0
Reduced Vol:	110	53	75	28	90	59	17	199	64	151	293	28
PCE Adj:	1.00	1.00	1.00	1.00	1.00	1.00	1.00	1.00	1.00	1.00	1.00	1.00
MLF Adj:	1.00	1.00	1.00	1.00	1.00	1.00	1.00	1.00	1.00	1.00	1.00	1.00
Final Volume:	110	53	75	28	90	59	17	199	64	151	293	28
Saturation Flow Module:												
Sat/Lane:	1900	1900	1900	1900	1900	1900	1900	1900	1900	1900	1900	1900
Adjustment:	0.92	1.00	0.92	0.92	1.00	0.92	0.92	0.98	0.95	0.92	0.98	0.95
Lanes:	1.00	1.00	1.00	1.00	1.00	1.00	1.00	1.50	0.50	1.00	1.82	0.18
Final Sat.:	1750	1900	1750	1750	1900	1750	1750	2799	900	1750	3377	323
Capacity Analysis Module:												
Vol/Sat:	0.06	0.03	0.04	0.02	0.05	0.03	0.01	0.07	0.07	0.09	0.09	0.09
Crit Moves:	****				****			****		****		
Green Time:	20.7	21.3	21.3	14.9	15.6	15.6	21.3	23.4	23.4	28.4	30.4	30.4
Volume/Cap:	0.30	0.13	0.20	0.11	0.30	0.22	0.05	0.30	0.30	0.30	0.28	0.28
Delay/Veh:	34.1	32.0	32.6	37.0	38.0	37.3	31.3	31.8	31.8	28.4	26.6	26.6
User DelAdj:	1.00	1.00	1.00	1.00	1.00	1.00	1.00	1.00	1.00	1.00	1.00	1.00
AdjDel/Veh:	34.1	32.0	32.6	37.0	38.0	37.3	31.3	31.8	31.8	28.4	26.6	26.6
LOS by Move:	C-	C	C-	D+	D+	D+	C	C	C	C	C	C
HCM2kAvgQ:	3	1	2	1	3	2	0	3	3	4	4	4

Note: Queue reported is the number of cars per lane.

San Antonio Village Phase III MTA
 SJ21-2068
 Existing AM

Level Of Service Computation Report
 2000 HCM Operations (Future Volume Alternative)
 Existing PP AM

Intersection #12: California Street and Showers Drive

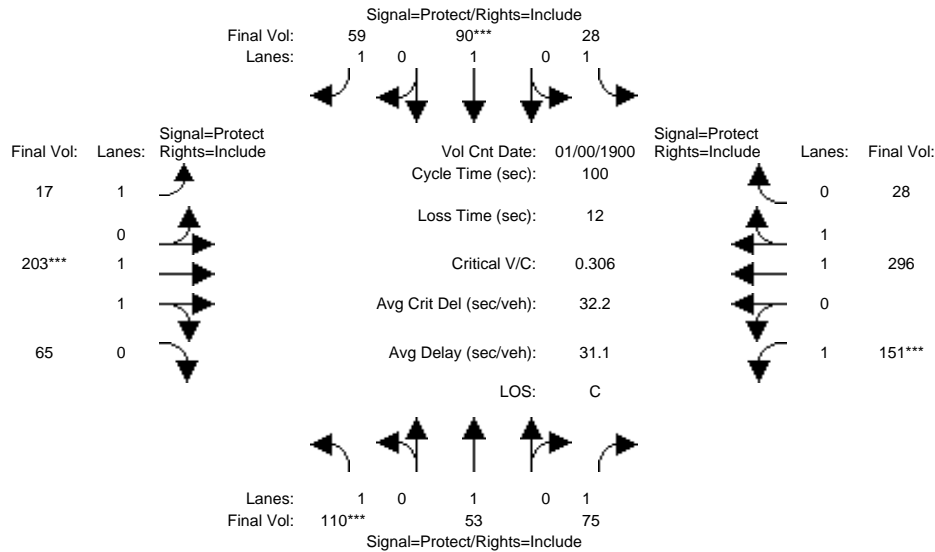

Approach:	North Bound			South Bound			East Bound			West Bound		
Movement:	L	T	R	L	T	R	L	T	R	L	T	R
Min. Green:	7	10	10	7	10	10	7	10	10	7	10	10
Y+R:	4.0	4.0	4.0	4.0	4.0	4.0	4.0	4.0	4.0	4.0	4.0	4.0
Volume Module: >> Count Date: 0 Jan 1900 << 12:00:00 AM												
Base Vol:	110	53	75	28	90	59	17	199	64	151	293	28
Growth Adj:	1.00	1.00	1.00	1.00	1.00	1.00	1.00	1.00	1.00	1.00	1.00	1.00
Initial Bse:	110	53	75	28	90	59	17	199	64	151	293	28
Added Vol:	0	0	0	0	0	0	0	4	1	0	3	0
PasserByVol:	0	0	0	0	0	0	0	0	0	0	0	0
Initial Fut:	110	53	75	28	90	59	17	203	65	151	296	28
User Adj:	1.00	1.00	1.00	1.00	1.00	1.00	1.00	1.00	1.00	1.00	1.00	1.00
PHF Adj:	1.00	1.00	1.00	1.00	1.00	1.00	1.00	1.00	1.00	1.00	1.00	1.00
PHF Volume:	110	53	75	28	90	59	17	203	65	151	296	28
Reduct Vol:	0	0	0	0	0	0	0	0	0	0	0	0
Reduced Vol:	110	53	75	28	90	59	17	203	65	151	296	28
PCE Adj:	1.00	1.00	1.00	1.00	1.00	1.00	1.00	1.00	1.00	1.00	1.00	1.00
MLF Adj:	1.00	1.00	1.00	1.00	1.00	1.00	1.00	1.00	1.00	1.00	1.00	1.00
FinalVolume:	110	53	75	28	90	59	17	203	65	151	296	28
Saturation Flow Module:												
Sat/Lane:	1900	1900	1900	1900	1900	1900	1900	1900	1900	1900	1900	1900
Adjustment:	0.92	1.00	0.92	0.92	1.00	0.92	0.92	0.98	0.95	0.92	0.98	0.95
Lanes:	1.00	1.00	1.00	1.00	1.00	1.00	1.00	1.50	0.50	1.00	1.82	0.18
Final Sat.:	1750	1900	1750	1750	1900	1750	1750	2802	897	1750	3380	320
Capacity Analysis Module:												
Vol/Sat:	0.06	0.03	0.04	0.02	0.05	0.03	0.01	0.07	0.07	0.09	0.09	0.09
Crit Moves:	****			****			****			****		
Green Time:	20.6	21.2	21.2	14.8	15.5	15.5	21.4	23.7	23.7	28.2	30.6	30.6
Volume/Cap:	0.31	0.13	0.20	0.11	0.31	0.22	0.05	0.31	0.31	0.31	0.29	0.29
Delay/Veh:	34.1	32.1	32.7	37.0	38.1	37.4	31.3	31.6	31.6	28.5	26.6	26.6
User DelAdj:	1.00	1.00	1.00	1.00	1.00	1.00	1.00	1.00	1.00	1.00	1.00	1.00
AdjDel/Veh:	34.1	32.1	32.7	37.0	38.1	37.4	31.3	31.6	31.6	28.5	26.6	26.6
LOS by Move:	C-	C-	C-	D+	D+	D+	C	C	C	C	C	C
HCM2kAvgQ:	3	1	2	1	3	2	0	3	3	4	4	4

Note: Queue reported is the number of cars per lane.

San Antonio Village Phase III MTA
 SJ21-2068
 Existing AM

Level Of Service Computation Report
 2000 HCM Operations (Future Volume Alternative)
 Existing AM

Intersection #13: California Street and Ortega Avenue

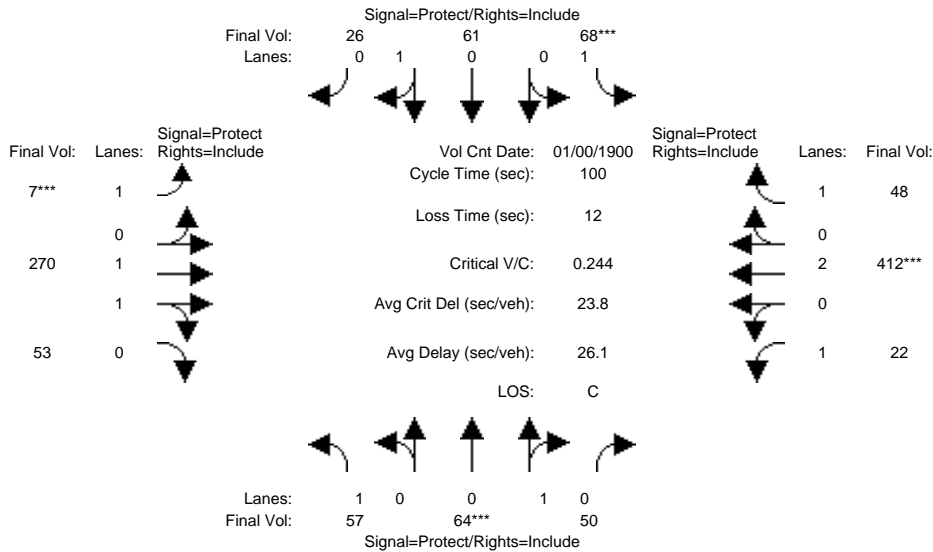

Approach:	North Bound			South Bound			East Bound			West Bound		
	L	T	R	L	T	R	L	T	R	L	T	R
Min. Green:	7	10	10	7	10	10	7	10	10	7	10	10
Y+R:	4.0	4.0	4.0	4.0	4.0	4.0	4.0	4.0	4.0	4.0	4.0	4.0
Volume Module: >> Count Date: 0 Jan 1900 << 12:00:00 AM												
Base Vol:	57	64	50	68	61	26	7	270	53	22	412	48
Growth Adj:	1.00	1.00	1.00	1.00	1.00	1.00	1.00	1.00	1.00	1.00	1.00	1.00
Initial Bse:	57	64	50	68	61	26	7	270	53	22	412	48
Added Vol:	0	0	0	0	0	0	0	0	0	0	0	0
PasserByVol:	0	0	0	0	0	0	0	0	0	0	0	0
Initial Fut:	57	64	50	68	61	26	7	270	53	22	412	48
User Adj:	1.00	1.00	1.00	1.00	1.00	1.00	1.00	1.00	1.00	1.00	1.00	1.00
PHF Adj:	1.00	1.00	1.00	1.00	1.00	1.00	1.00	1.00	1.00	1.00	1.00	1.00
PHF Volume:	57	64	50	68	61	26	7	270	53	22	412	48
Reduct Vol:	0	0	0	0	0	0	0	0	0	0	0	0
Reduced Vol:	57	64	50	68	61	26	7	270	53	22	412	48
PCE Adj:	1.00	1.00	1.00	1.00	1.00	1.00	1.00	1.00	1.00	1.00	1.00	1.00
MLF Adj:	1.00	1.00	1.00	1.00	1.00	1.00	1.00	1.00	1.00	1.00	1.00	1.00
FinalVolume:	57	64	50	68	61	26	7	270	53	22	412	48
Saturation Flow Module:												
Sat/Lane:	1900	1900	1900	1900	1900	1900	1900	1900	1900	1900	1900	1900
Adjustment:	0.92	0.95	0.95	0.92	0.95	0.95	0.92	0.98	0.95	0.92	1.00	0.92
Lanes:	1.00	0.56	0.44	1.00	0.70	0.30	1.00	1.66	0.34	1.00	2.00	1.00
Final Sat.:	1750	1011	789	1750	1262	538	1750	3092	607	1750	3800	1750
Capacity Analysis Module:												
Vol/Sat:	0.03	0.06	0.06	0.04	0.05	0.05	0.00	0.09	0.09	0.01	0.11	0.03
Crit Moves:	****	****	****	****	****	****	****	****	****	****	****	****
Green Time:	16.2	24.4	24.4	14.9	23.1	23.1	7.0	28.6	28.6	20.1	41.7	41.7
Volume/Cap:	0.20	0.26	0.26	0.26	0.21	0.21	0.06	0.30	0.30	0.06	0.26	0.07
Delay/Veh:	36.7	30.9	30.9	38.2	31.3	31.3	43.6	28.1	28.1	32.4	19.2	17.5
User DelAdj:	1.00	1.00	1.00	1.00	1.00	1.00	1.00	1.00	1.00	1.00	1.00	1.00
AdjDel/Veh:	36.7	30.9	30.9	38.2	31.3	31.3	43.6	28.1	28.1	32.4	19.2	17.5
LOS by Move:	D+	C	C	D+	C	C	D	C	C	C-	B-	B
HCM2kAvgQ:	2	3	3	2	2	2	0	4	4	1	4	1

Note: Queue reported is the number of cars per lane.

San Antonio Village Phase III MTA
 SJ21-2068
 Existing AM

Level Of Service Computation Report
 2000 HCM Operations (Future Volume Alternative)
 Existing PP AM

Intersection #13: California Street and Ortega Avenue

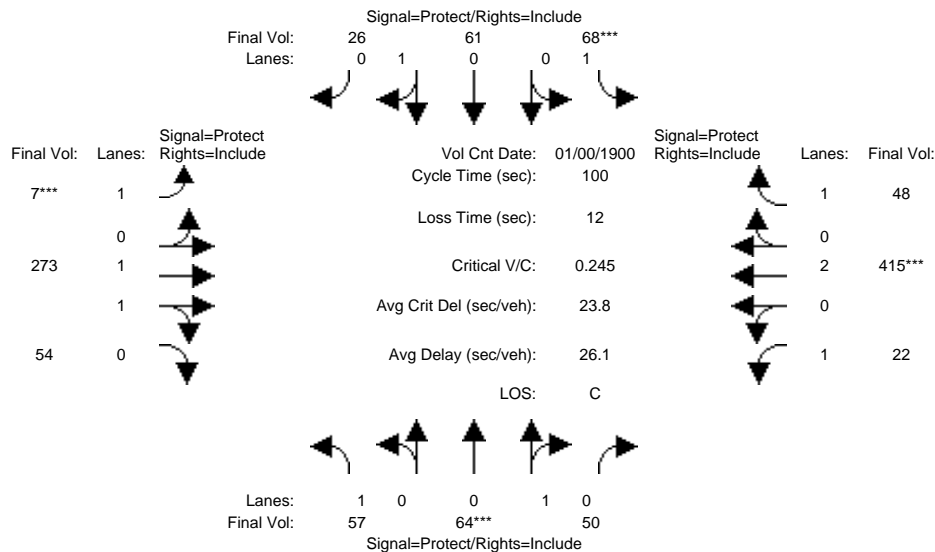

Approach:	North Bound			South Bound			East Bound			West Bound		
Movement:	L	T	R	L	T	R	L	T	R	L	T	R
Min. Green:	7	10	10	7	10	10	7	10	10	7	10	10
Y+R:	4.0	4.0	4.0	4.0	4.0	4.0	4.0	4.0	4.0	4.0	4.0	4.0
Volume Module: >> Count Date: 0 Jan 1900 << 12:00:00 AM												
Base Vol:	57	64	50	68	61	26	7	270	53	22	412	48
Growth Adj:	1.00	1.00	1.00	1.00	1.00	1.00	1.00	1.00	1.00	1.00	1.00	1.00
Initial Bse:	57	64	50	68	61	26	7	270	53	22	412	48
Added Vol:	0	0	0	0	0	0	0	3	1	0	3	0
PasserByVol:	0	0	0	0	0	0	0	0	0	0	0	0
Initial Fut:	57	64	50	68	61	26	7	273	54	22	415	48
User Adj:	1.00	1.00	1.00	1.00	1.00	1.00	1.00	1.00	1.00	1.00	1.00	1.00
PHF Adj:	1.00	1.00	1.00	1.00	1.00	1.00	1.00	1.00	1.00	1.00	1.00	1.00
PHF Volume:	57	64	50	68	61	26	7	273	54	22	415	48
Reduct Vol:	0	0	0	0	0	0	0	0	0	0	0	0
Reduced Vol:	57	64	50	68	61	26	7	273	54	22	415	48
PCE Adj:	1.00	1.00	1.00	1.00	1.00	1.00	1.00	1.00	1.00	1.00	1.00	1.00
MLF Adj:	1.00	1.00	1.00	1.00	1.00	1.00	1.00	1.00	1.00	1.00	1.00	1.00
FinalVolume:	57	64	50	68	61	26	7	273	54	22	415	48
Saturation Flow Module:												
Sat/Lane:	1900	1900	1900	1900	1900	1900	1900	1900	1900	1900	1900	1900
Adjustment:	0.92	0.95	0.95	0.92	0.95	0.95	0.92	0.98	0.95	0.92	1.00	0.92
Lanes:	1.00	0.56	0.44	1.00	0.70	0.30	1.00	1.66	0.34	1.00	2.00	1.00
Final Sat.:	1750	1011	789	1750	1262	538	1750	3089	611	1750	3800	1750
Capacity Analysis Module:												
Vol/Sat:	0.03	0.06	0.06	0.04	0.05	0.05	0.00	0.09	0.09	0.01	0.11	0.03
Crit Moves:	****			****			****			****		
Green Time:	16.1	24.3	24.3	14.9	23.0	23.0	7.0	28.7	28.7	20.1	41.8	41.8
Volume/Cap:	0.20	0.26	0.26	0.26	0.21	0.21	0.06	0.31	0.31	0.06	0.26	0.07
Delay/Veh:	36.7	30.9	30.9	38.2	31.4	31.4	43.6	28.0	28.0	32.4	19.1	17.4
User DelAdj:	1.00	1.00	1.00	1.00	1.00	1.00	1.00	1.00	1.00	1.00	1.00	1.00
AdjDel/Veh:	36.7	30.9	30.9	38.2	31.4	31.4	43.6	28.0	28.0	32.4	19.1	17.4
LOS by Move:	D+	C	C	D+	C	C	D	C	C	C-	B-	B
HCM2kAvgQ:	2	3	3	2	2	2	0	4	4	1	4	1

Note: Queue reported is the number of cars per lane.

San Antonio Village Phase III MTA
 SJ21-2068
 Existing AM

Level Of Service Computation Report
 2000 HCM Operations (Future Volume Alternative)
 Existing AM

Intersection #14: California Street and Rengstorff Avenue

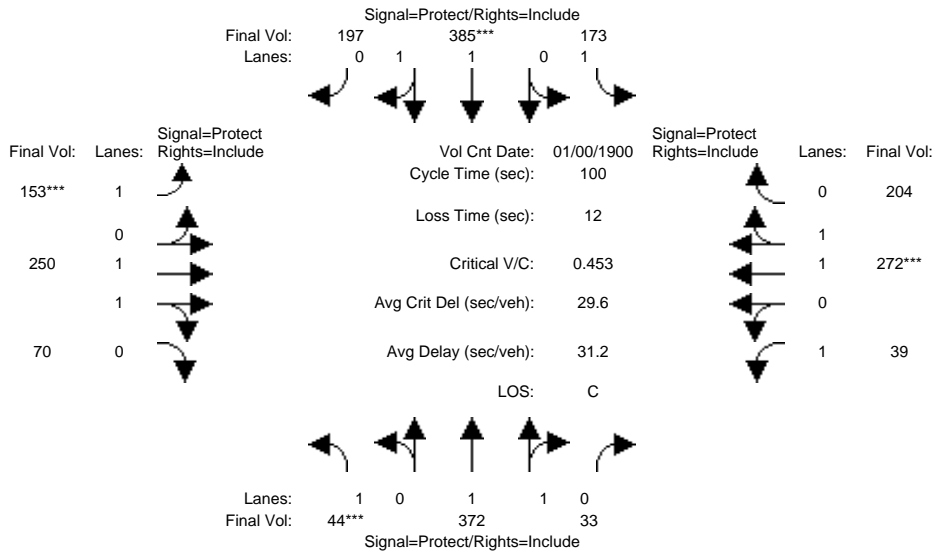

Approach:	North Bound			South Bound			East Bound			West Bound		
Movement:	L	T	R	L	T	R	L	T	R	L	T	R
Min. Green:	7	10	10	7	10	10	7	10	10	7	10	10
Y+R:	4.0	4.0	4.0	4.0	4.0	4.0	4.0	4.0	4.0	4.0	4.0	4.0
Volume Module: >> Count Date: 0 Jan 1900 << 12:00:00 AM												
Base Vol:	44	372	33	173	385	197	153	250	70	39	272	204
Growth Adj:	1.00	1.00	1.00	1.00	1.00	1.00	1.00	1.00	1.00	1.00	1.00	1.00
Initial Bse:	44	372	33	173	385	197	153	250	70	39	272	204
Added Vol:	0	0	0	0	0	0	0	0	0	0	0	0
PasserByVol:	0	0	0	0	0	0	0	0	0	0	0	0
Initial Fut:	44	372	33	173	385	197	153	250	70	39	272	204
User Adj:	1.00	1.00	1.00	1.00	1.00	1.00	1.00	1.00	1.00	1.00	1.00	1.00
PHF Adj:	1.00	1.00	1.00	1.00	1.00	1.00	1.00	1.00	1.00	1.00	1.00	1.00
PHF Volume:	44	372	33	173	385	197	153	250	70	39	272	204
Reduct Vol:	0	0	0	0	0	0	0	0	0	0	0	0
Reduced Vol:	44	372	33	173	385	197	153	250	70	39	272	204
PCE Adj:	1.00	1.00	1.00	1.00	1.00	1.00	1.00	1.00	1.00	1.00	1.00	1.00
MLF Adj:	1.00	1.00	1.00	1.00	1.00	1.00	1.00	1.00	1.00	1.00	1.00	1.00
Final Volume:	44	372	33	173	385	197	153	250	70	39	272	204
Saturation Flow Module:												
Sat/Lane:	1900	1900	1900	1900	1900	1900	1900	1900	1900	1900	1900	1900
Adjustment:	0.92	0.98	0.95	0.92	0.99	0.95	0.92	0.98	0.95	0.92	0.99	0.95
Lanes:	1.00	1.83	0.17	1.00	1.30	0.70	1.00	1.55	0.45	1.00	1.12	0.88
Final Sat.:	1750	3398	301	1750	2447	1252	1750	2890	809	1750	2113	1585
Capacity Analysis Module:												
Vol/Sat:	0.03	0.11	0.11	0.10	0.16	0.16	0.09	0.09	0.09	0.02	0.13	0.13
Crit Moves:	****			****			****			****		
Green Time:	7.0	21.6	21.6	19.5	34.1	34.1	19.0	27.6	27.6	19.3	27.9	27.9
Volume/Cap:	0.36	0.51	0.51	0.51	0.46	0.46	0.46	0.31	0.31	0.12	0.46	0.46
Delay/Veh:	46.2	35.0	35.0	37.2	26.0	26.0	37.0	28.9	28.9	33.5	30.1	30.1
User DelAdj:	1.00	1.00	1.00	1.00	1.00	1.00	1.00	1.00	1.00	1.00	1.00	1.00
AdjDel/Veh:	46.2	35.0	35.0	37.2	26.0	26.0	37.0	28.9	28.9	33.5	30.1	30.1
LOS by Move:	D	D+	D+	D+	C	C	D+	C	C	C-	C	C
HCM2kAvgQ:	1	6	6	5	7	7	4	4	4	1	6	6

Note: Queue reported is the number of cars per lane.

San Antonio Village Phase III MTA
 SJ21-2068
 Existing AM

Level Of Service Computation Report
 2000 HCM Operations (Future Volume Alternative)
 Existing PP AM

Intersection #14: California Street and Rengstorff Avenue

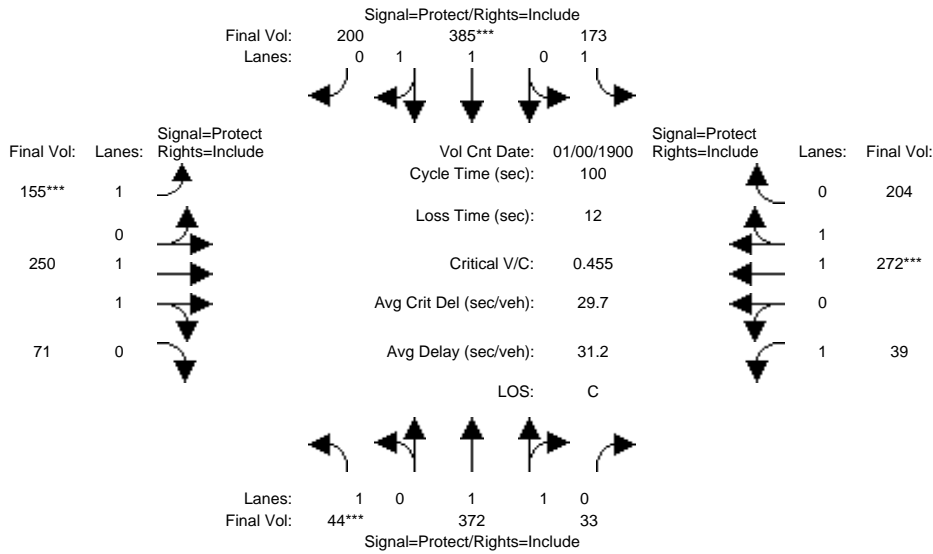

Approach:	North Bound			South Bound			East Bound			West Bound		
	L	T	R	L	T	R	L	T	R	L	T	R
Min. Green:	7	10	10	7	10	10	7	10	10	7	10	10
Y+R:	4.0	4.0	4.0	4.0	4.0	4.0	4.0	4.0	4.0	4.0	4.0	4.0
Volume Module: >> Count Date: 0 Jan 1900 << 12:00:00 AM												
Base Vol:	44	372	33	173	385	197	153	250	70	39	272	204
Growth Adj:	1.00	1.00	1.00	1.00	1.00	1.00	1.00	1.00	1.00	1.00	1.00	1.00
Initial Bse:	44	372	33	173	385	197	153	250	70	39	272	204
Added Vol:	0	0	0	0	0	3	2	0	1	0	0	0
PasserByVol:	0	0	0	0	0	0	0	0	0	0	0	0
Initial Fut:	44	372	33	173	385	200	155	250	71	39	272	204
User Adj:	1.00	1.00	1.00	1.00	1.00	1.00	1.00	1.00	1.00	1.00	1.00	1.00
PHF Adj:	1.00	1.00	1.00	1.00	1.00	1.00	1.00	1.00	1.00	1.00	1.00	1.00
PHF Volume:	44	372	33	173	385	200	155	250	71	39	272	204
Reduct Vol:	0	0	0	0	0	0	0	0	0	0	0	0
Reduced Vol:	44	372	33	173	385	200	155	250	71	39	272	204
PCE Adj:	1.00	1.00	1.00	1.00	1.00	1.00	1.00	1.00	1.00	1.00	1.00	1.00
MLF Adj:	1.00	1.00	1.00	1.00	1.00	1.00	1.00	1.00	1.00	1.00	1.00	1.00
FinalVolume:	44	372	33	173	385	200	155	250	71	39	272	204
Saturation Flow Module:												
Sat/Lane:	1900	1900	1900	1900	1900	1900	1900	1900	1900	1900	1900	1900
Adjustment:	0.92	0.98	0.95	0.92	0.99	0.95	0.92	0.98	0.95	0.92	0.99	0.95
Lanes:	1.00	1.83	0.17	1.00	1.30	0.70	1.00	1.55	0.45	1.00	1.12	0.88
Final Sat.:	1750	3398	301	1750	2434	1264	1750	2881	818	1750	2113	1585
Capacity Analysis Module:												
Vol/Sat:	0.03	0.11	0.11	0.10	0.16	0.16	0.09	0.09	0.09	0.02	0.13	0.13
Crit Moves:	****			****			****			****		
Green Time:	7.0	21.6	21.6	19.5	34.1	34.1	19.1	27.6	27.6	19.3	27.8	27.8
Volume/Cap:	0.36	0.51	0.51	0.51	0.46	0.46	0.46	0.31	0.31	0.12	0.46	0.46
Delay/Veh:	46.2	35.0	35.0	37.2	26.0	26.0	36.9	28.9	28.9	33.5	30.3	30.3
User DelAdj:	1.00	1.00	1.00	1.00	1.00	1.00	1.00	1.00	1.00	1.00	1.00	1.00
AdjDel/Veh:	46.2	35.0	35.0	37.2	26.0	26.0	36.9	28.9	28.9	33.5	30.3	30.3
LOS by Move:	D	D+	D+	D+	C	C	D+	C	C	C-	C	C
HCM2kAvgQ:	1	6	6	5	7	7	4	4	4	1	6	6

Note: Queue reported is the number of cars per lane.

San Antonio Village Phase III MTA
 SJ21-2068
 Existing AM

Level Of Service Computation Report
 2000 HCM Operations (Future Volume Alternative)
 Existing AM

Intersection #15: Central Expressway and Rengstorff Avenue

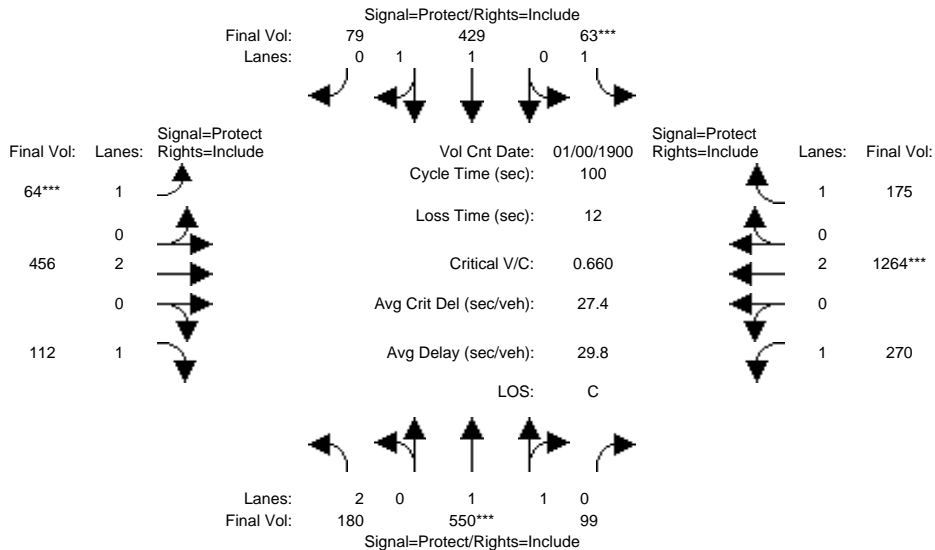

Approach:	North Bound			South Bound			East Bound			West Bound		
	L	T	R	L	T	R	L	T	R	L	T	R
Min. Green:	7	10	10	7	10	10	7	10	10	7	10	10
Y+R:	4.0	4.0	4.0	4.0	4.0	4.0	4.0	4.0	4.0	4.0	4.0	4.0
Volume Module: >> Count Date: 0 Jan 1900 << 12:00:00 AM												
Base Vol:	180	550	99	63	429	79	64	456	112	270	1264	175
Growth Adj:	1.00	1.00	1.00	1.00	1.00	1.00	1.00	1.00	1.00	1.00	1.00	1.00
Initial Bse:	180	550	99	63	429	79	64	456	112	270	1264	175
Added Vol:	0	0	0	0	0	0	0	0	0	0	0	0
PasserByVol:	0	0	0	0	0	0	0	0	0	0	0	0
Initial Fut:	180	550	99	63	429	79	64	456	112	270	1264	175
User Adj:	1.00	1.00	1.00	1.00	1.00	1.00	1.00	1.00	1.00	1.00	1.00	1.00
PHF Adj:	1.00	1.00	1.00	1.00	1.00	1.00	1.00	1.00	1.00	1.00	1.00	1.00
PHF Volume:	180	550	99	63	429	79	64	456	112	270	1264	175
Reduct Vol:	0	0	0	0	0	0	0	0	0	0	0	0
Reduced Vol:	180	550	99	63	429	79	64	456	112	270	1264	175
PCE Adj:	1.00	1.00	1.00	1.00	1.00	1.00	1.00	1.00	1.00	1.00	1.00	1.00
MLF Adj:	1.00	1.00	1.00	1.00	1.00	1.00	1.00	1.00	1.00	1.00	1.00	1.00
Final Volume:	180	550	99	63	429	79	64	456	112	270	1264	175
Saturation Flow Module:												
Sat/Lane:	1900	1900	1900	1900	1900	1900	1900	1900	1900	1900	1900	1900
Adjustment:	0.83	0.98	0.95	0.92	0.98	0.95	0.92	1.00	0.92	0.92	1.00	0.92
Lanes:	2.00	1.69	0.31	1.00	1.68	0.32	1.00	2.00	1.00	1.00	2.00	1.00
Final Sat.:	3150	3135	564	1750	3124	575	1750	3800	1750	1750	3800	1750
Capacity Analysis Module:												
Vol/Sat:	0.06	0.18	0.18	0.04	0.14	0.14	0.04	0.12	0.06	0.15	0.33	0.10
Crit Moves:	****			****			****			****		
Green Time:	11.0	25.6	25.6	7.0	21.6	21.6	7.0	24.3	24.3	31.2	48.4	48.4
Volume/Cap:	0.52	0.69	0.69	0.51	0.64	0.64	0.52	0.49	0.26	0.49	0.69	0.21
Delay/Veh:	43.4	35.7	35.7	48.6	37.4	37.4	48.9	33.0	31.0	28.7	21.0	14.9
User DelAdj:	1.00	1.00	1.00	1.00	1.00	1.00	1.00	1.00	1.00	1.00	1.00	1.00
AdjDel/Veh:	43.4	35.7	35.7	48.6	37.4	37.4	48.9	33.0	31.0	28.7	21.0	14.9
LOS by Move:	D	D+	D+	D	D+	D+	D	C-	C	C	C+	B
HCM2kAvgQ:	3	9	9	3	8	8	2	6	3	8	16	3

Note: Queue reported is the number of cars per lane.

San Antonio Village Phase III MTA
 SJ21-2068
 Existing AM

Level Of Service Computation Report
 2000 HCM Operations (Future Volume Alternative)
 Existing PP AM

Intersection #15: Central Expressway and Rengstorff Avenue

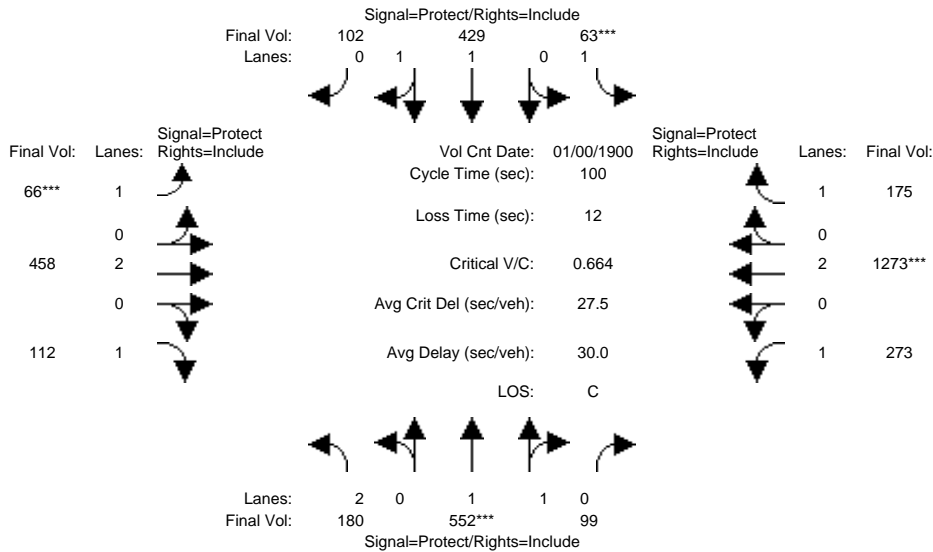

Approach:	North Bound			South Bound			East Bound			West Bound		
	L	T	R	L	T	R	L	T	R	L	T	R
Min. Green:	7	10	10	7	10	10	7	10	10	7	10	10
Y+R:	4.0	4.0	4.0	4.0	4.0	4.0	4.0	4.0	4.0	4.0	4.0	4.0
Volume Module: >> Count Date: 0 Jan 1900 << 12:00:00 AM												
Base Vol:	180	550	99	63	429	79	64	456	112	270	1264	175
Growth Adj:	1.00	1.00	1.00	1.00	1.00	1.00	1.00	1.00	1.00	1.00	1.00	1.00
Initial Bse:	180	550	99	63	429	79	64	456	112	270	1264	175
Added Vol:	0	2	0	0	0	23	2	2	0	3	9	0
PasserByVol:	0	0	0	0	0	0	0	0	0	0	0	0
Initial Fut:	180	552	99	63	429	102	66	458	112	273	1273	175
User Adj:	1.00	1.00	1.00	1.00	1.00	1.00	1.00	1.00	1.00	1.00	1.00	1.00
PHF Adj:	1.00	1.00	1.00	1.00	1.00	1.00	1.00	1.00	1.00	1.00	1.00	1.00
PHF Volume:	180	552	99	63	429	102	66	458	112	273	1273	175
Reduct Vol:	0	0	0	0	0	0	0	0	0	0	0	0
Reduced Vol:	180	552	99	63	429	102	66	458	112	273	1273	175
PCE Adj:	1.00	1.00	1.00	1.00	1.00	1.00	1.00	1.00	1.00	1.00	1.00	1.00
MLF Adj:	1.00	1.00	1.00	1.00	1.00	1.00	1.00	1.00	1.00	1.00	1.00	1.00
Final Volume:	180	552	99	63	429	102	66	458	112	273	1273	175
Saturation Flow Module:												
Sat/Lane:	1900	1900	1900	1900	1900	1900	1900	1900	1900	1900	1900	1900
Adjustment:	0.83	0.98	0.95	0.92	0.98	0.95	0.92	1.00	0.92	0.92	1.00	0.92
Lanes:	2.00	1.69	0.31	1.00	1.61	0.39	1.00	2.00	1.00	1.00	2.00	1.00
Final Sat.:	3150	3137	563	1750	2989	711	1750	3800	1750	1750	3800	1750
Capacity Analysis Module:												
Vol/Sat:	0.06	0.18	0.18	0.04	0.14	0.14	0.04	0.12	0.06	0.16	0.34	0.10
Crit Moves:	****			****			****			****		
Green Time:	10.6	25.5	25.5	7.0	21.8	21.8	7.0	24.2	24.2	31.3	48.5	48.5
Volume/Cap:	0.54	0.69	0.69	0.51	0.66	0.66	0.54	0.50	0.26	0.50	0.69	0.21
Delay/Veh:	44.1	35.9	35.9	48.6	37.7	37.7	49.7	33.1	31.0	28.7	21.1	14.8
User DelAdj:	1.00	1.00	1.00	1.00	1.00	1.00	1.00	1.00	1.00	1.00	1.00	1.00
AdjDel/Veh:	44.1	35.9	35.9	48.6	37.7	37.7	49.7	33.1	31.0	28.7	21.1	14.8
LOS by Move:	D	D+	D+	D	D+	D+	D	C-	C	C	C+	B
HCM2kAvgQ:	3	9	9	3	9	9	2	6	3	8	16	3

Note: Queue reported is the number of cars per lane.

San Antonio Village Phase III MTA
 SJ21-2068
 Existing AM

Level Of Service Computation Report
 2000 HCM Operations (Future Volume Alternative)
 Existing AM

Intersection #16: Middlefield Road and San Antonio Road

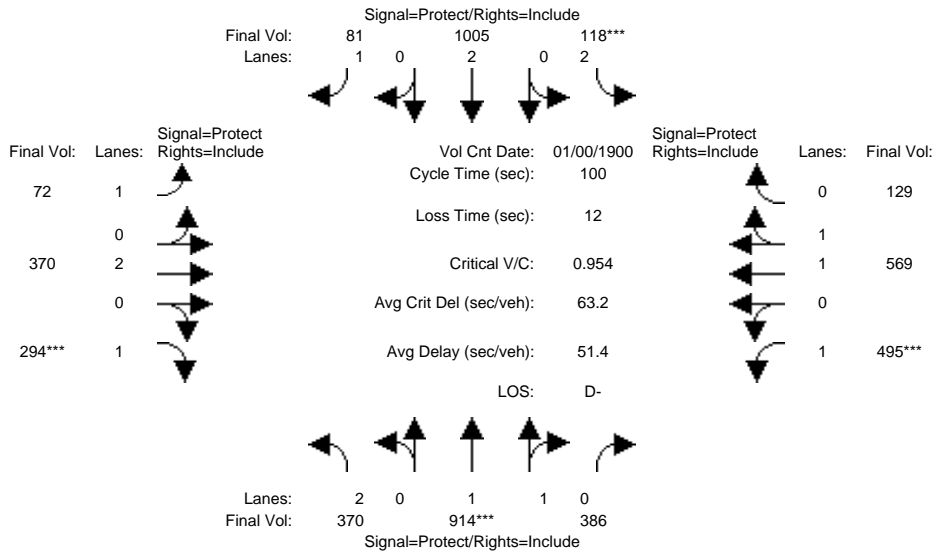

Approach:	North Bound			South Bound			East Bound			West Bound		
	L	T	R	L	T	R	L	T	R	L	T	R
Min. Green:	7	10	10	7	10	10	7	10	10	7	10	10
Y+R:	4.0	4.0	4.0	4.0	4.0	4.0	4.0	4.0	4.0	4.0	4.0	4.0
Volume Module: >> Count Date: 0 Jan 1900 << 12:00:00 AM												
Base Vol:	370	914	386	118	1005	81	72	370	294	495	569	129
Growth Adj:	1.00	1.00	1.00	1.00	1.00	1.00	1.00	1.00	1.00	1.00	1.00	1.00
Initial Bse:	370	914	386	118	1005	81	72	370	294	495	569	129
Added Vol:	0	0	0	0	0	0	0	0	0	0	0	0
PasserByVol:	0	0	0	0	0	0	0	0	0	0	0	0
Initial Fut:	370	914	386	118	1005	81	72	370	294	495	569	129
User Adj:	1.00	1.00	1.00	1.00	1.00	1.00	1.00	1.00	1.00	1.00	1.00	1.00
PHF Adj:	1.00	1.00	1.00	1.00	1.00	1.00	1.00	1.00	1.00	1.00	1.00	1.00
PHF Volume:	370	914	386	118	1005	81	72	370	294	495	569	129
Reduct Vol:	0	0	0	0	0	0	0	0	0	0	0	0
Reduced Vol:	370	914	386	118	1005	81	72	370	294	495	569	129
PCE Adj:	1.00	1.00	1.00	1.00	1.00	1.00	1.00	1.00	1.00	1.00	1.00	1.00
MLF Adj:	1.00	1.00	1.00	1.00	1.00	1.00	1.00	1.00	1.00	1.00	1.00	1.00
Final Volume:	370	914	386	118	1005	81	72	370	294	495	569	129
Saturation Flow Module:												
Sat/Lane:	1900	1900	1900	1900	1900	1900	1900	1900	1900	1900	1900	1900
Adjustment:	0.83	0.98	0.95	0.83	1.00	0.92	0.92	1.00	0.92	0.92	0.98	0.95
Lanes:	2.00	1.39	0.61	2.00	2.00	1.00	1.00	2.00	1.00	1.00	1.62	0.38
Final Sat.:	3150	2601	1098	3150	3800	1750	1750	3800	1750	1750	3016	684
Capacity Analysis Module:												
Vol/Sat:	0.12	0.35	0.35	0.04	0.26	0.05	0.04	0.10	0.17	0.28	0.19	0.19
Crit Moves:	****			****			****			****		
Green Time:	13.1	35.5	35.5	7.0	29.4	29.4	12.3	17.0	17.0	28.6	33.2	33.2
Volume/Cap:	0.90	0.99	0.99	0.54	0.90	0.16	0.33	0.57	0.99	0.99	0.57	0.57
Delay/Veh:	64.8	54.6	54.6	47.5	43.7	26.3	41.0	39.5	90.9	73.3	28.1	28.1
User DelAdj:	1.00	1.00	1.00	1.00	1.00	1.00	1.00	1.00	1.00	1.00	1.00	1.00
AdjDel/Veh:	64.8	54.6	54.6	47.5	43.7	26.3	41.0	39.5	90.9	73.3	28.1	28.1
LOS by Move:	E	D-	D-	D	D	C	D	D	F	E	C	C
HCM2kAvgQ:	8	24	24	2	17	2	2	6	15	23	9	9

Note: Queue reported is the number of cars per lane.

San Antonio Village Phase III MTA
 SJ21-2068
 Existing AM

Level Of Service Computation Report
 2000 HCM Operations (Future Volume Alternative)
 Existing PP AM

Intersection #16: Middlefield Road and San Antonio Road

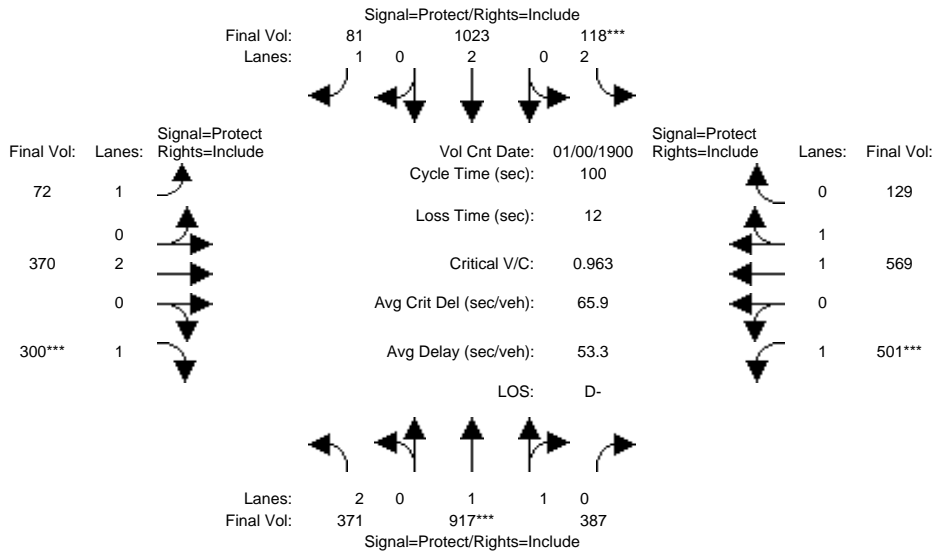

Approach:	North Bound			South Bound			East Bound			West Bound		
Movement:	L	T	R	L	T	R	L	T	R	L	T	R
Min. Green:	7	10	10	7	10	10	7	10	10	7	10	10
Y+R:	4.0	4.0	4.0	4.0	4.0	4.0	4.0	4.0	4.0	4.0	4.0	4.0
Volume Module: >> Count Date: 0 Jan 1900 << 12:00:00 AM												
Base Vol:	370	914	386	118	1005	81	72	370	294	495	569	129
Growth Adj:	1.00	1.00	1.00	1.00	1.00	1.00	1.00	1.00	1.00	1.00	1.00	1.00
Initial Bse:	370	914	386	118	1005	81	72	370	294	495	569	129
Added Vol:	1	3	1	0	18	0	0	0	6	6	0	0
PasserByVol:	0	0	0	0	0	0	0	0	0	0	0	0
Initial Fut:	371	917	387	118	1023	81	72	370	300	501	569	129
User Adj:	1.00	1.00	1.00	1.00	1.00	1.00	1.00	1.00	1.00	1.00	1.00	1.00
PHF Adj:	1.00	1.00	1.00	1.00	1.00	1.00	1.00	1.00	1.00	1.00	1.00	1.00
PHF Volume:	371	917	387	118	1023	81	72	370	300	501	569	129
Reduct Vol:	0	0	0	0	0	0	0	0	0	0	0	0
Reduced Vol:	371	917	387	118	1023	81	72	370	300	501	569	129
PCE Adj:	1.00	1.00	1.00	1.00	1.00	1.00	1.00	1.00	1.00	1.00	1.00	1.00
MLF Adj:	1.00	1.00	1.00	1.00	1.00	1.00	1.00	1.00	1.00	1.00	1.00	1.00
FinalVolume:	371	917	387	118	1023	81	72	370	300	501	569	129
Saturation Flow Module:												
Sat/Lane:	1900	1900	1900	1900	1900	1900	1900	1900	1900	1900	1900	1900
Adjustment:	0.83	0.98	0.95	0.83	1.00	0.92	0.92	1.00	0.92	0.92	0.98	0.95
Lanes:	2.00	1.39	0.61	2.00	2.00	1.00	1.00	2.00	1.00	1.00	1.62	0.38
Final Sat.:	3150	2601	1098	3150	3800	1750	1750	3800	1750	1750	3016	684
Capacity Analysis Module:												
Vol/Sat:	0.12	0.35	0.35	0.04	0.27	0.05	0.04	0.10	0.17	0.29	0.19	0.19
Crit Moves:	****			****			****			****		
Green Time:	12.9	35.2	35.2	7.0	29.4	29.4	12.4	17.1	17.1	28.6	33.4	33.4
Volume/Cap:	0.92	1.00	1.00	0.54	0.92	0.16	0.33	0.57	1.00	1.00	0.57	0.57
Delay/Veh:	68.2	57.4	57.4	47.5	45.8	26.3	40.9	39.2	93.5	76.0	28.0	28.0
User DelAdj:	1.00	1.00	1.00	1.00	1.00	1.00	1.00	1.00	1.00	1.00	1.00	1.00
AdjDel/Veh:	68.2	57.4	57.4	47.5	45.8	26.3	40.9	39.2	93.5	76.0	28.0	28.0
LOS by Move:	E	E+	E+	D	D	C	D	D	F	E-	C	C
HCM2kAvgQ:	8	25	25	2	17	2	2	6	15	23	9	9

Note: Queue reported is the number of cars per lane.

San Antonio Village Phase III MTA
 SJ21-2068
 Existing AM

Level Of Service Computation Report
 2000 HCM Operations (Future Volume Alternative)
 Existing AM

Intersection #17: Charleston Road and San Antonio Road

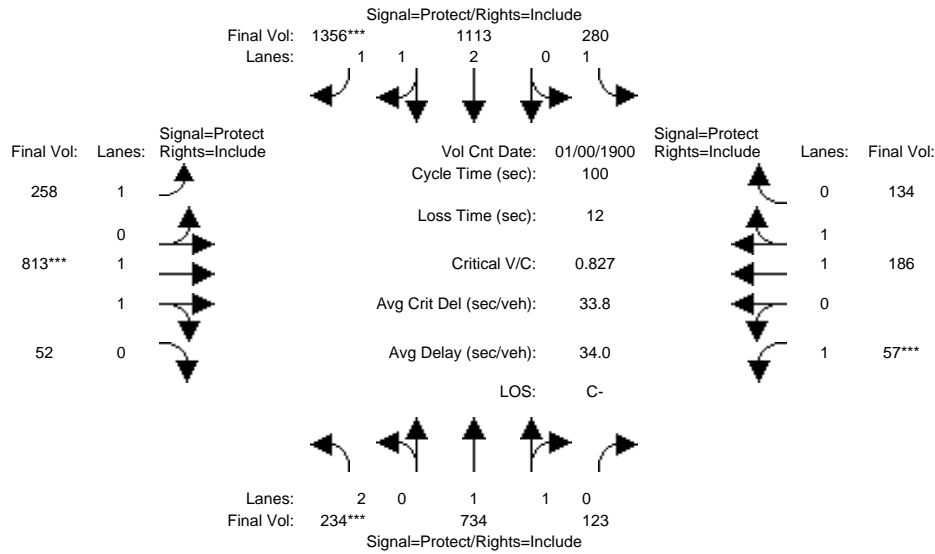

Approach:	North Bound			South Bound			East Bound			West Bound		
	L	T	R	L	T	R	L	T	R	L	T	R
Min. Green:	7	10	10	7	10	10	7	10	10	7	10	10
Y+R:	4.0	4.0	4.0	4.0	4.0	4.0	4.0	4.0	4.0	4.0	4.0	4.0
Volume Module: >> Count Date: 0 Jan 1900 << 12:00:00 AM												
Base Vol:	234	734	123	280	1113	1356	258	813	52	57	186	134
Growth Adj:	1.00	1.00	1.00	1.00	1.00	1.00	1.00	1.00	1.00	1.00	1.00	1.00
Initial Bse:	234	734	123	280	1113	1356	258	813	52	57	186	134
Added Vol:	0	0	0	0	0	0	0	0	0	0	0	0
PasserByVol:	0	0	0	0	0	0	0	0	0	0	0	0
Initial Fut:	234	734	123	280	1113	1356	258	813	52	57	186	134
User Adj:	1.00	1.00	1.00	1.00	1.00	1.00	1.00	1.00	1.00	1.00	1.00	1.00
PHF Adj:	1.00	1.00	1.00	1.00	1.00	1.00	1.00	1.00	1.00	1.00	1.00	1.00
PHF Volume:	234	734	123	280	1113	1356	258	813	52	57	186	134
Reduct Vol:	0	0	0	0	0	0	0	0	0	0	0	0
Reduced Vol:	234	734	123	280	1113	1356	258	813	52	57	186	134
PCE Adj:	1.00	1.00	1.00	1.00	1.00	1.00	1.00	1.00	1.00	1.00	1.00	1.00
MLF Adj:	1.00	1.00	1.00	1.00	1.00	1.00	1.00	1.00	1.00	1.00	1.00	1.00
Final Volume:	234	734	123	280	1113	1356	258	813	52	57	186	134
Saturation Flow Module:												
Sat/Lane:	1900	1900	1900	1900	1900	1900	1900	1900	1900	1900	1900	1900
Adjustment:	0.83	0.98	0.95	0.92	1.00	0.92	0.92	0.98	0.95	0.92	0.99	0.95
Lanes:	2.00	1.71	0.29	1.00	2.00	2.00	1.00	1.88	0.12	1.00	1.14	0.86
Final Sat.:	3150	3169	531	1750	3800	3500	1750	3477	222	1750	2149	1549
Capacity Analysis Module:												
Vol/Sat:	0.07	0.23	0.23	0.16	0.29	0.39	0.15	0.23	0.23	0.03	0.09	0.09
Crit Moves:	****					****		****		****		
Green Time:	8.7	31.8	31.8	22.0	45.1	45.1	20.4	27.2	27.2	7.0	13.8	13.8
Volume/Cap:	0.86	0.73	0.73	0.73	0.65	0.86	0.72	0.86	0.86	0.47	0.63	0.63
Delay/Veh:	67.9	32.6	32.6	43.1	21.7	27.4	44.3	42.1	42.1	47.5	43.1	43.1
User DelAdj:	1.00	1.00	1.00	1.00	1.00	1.00	1.00	1.00	1.00	1.00	1.00	1.00
AdjDel/Veh:	67.9	32.6	32.6	43.1	21.7	27.4	44.3	42.1	42.1	47.5	43.1	43.1
LOS by Move:	E	C-	C-	D	C+	C	D	D	D	D	D	D
HCM2kAvgQ:	5	12	12	10	14	23	10	16	16	2	6	6

Note: Queue reported is the number of cars per lane.

San Antonio Village Phase III MTA
 SJ21-2068
 Existing AM

Level Of Service Computation Report
 2000 HCM Operations (Future Volume Alternative)
 Existing PP AM

Intersection #17: Charleston Road and San Antonio Road

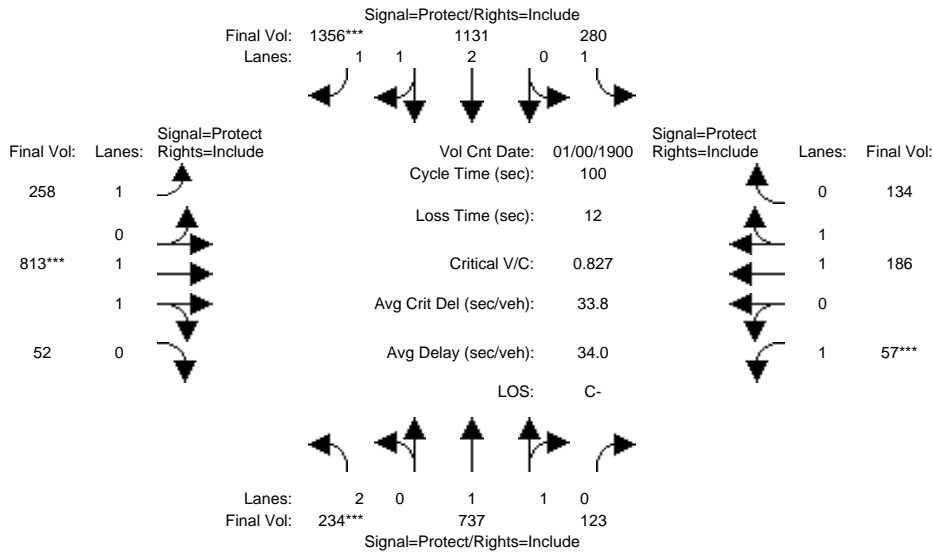

Approach:	North Bound			South Bound			East Bound			West Bound		
	L	T	R	L	T	R	L	T	R	L	T	R
Min. Green:	7	10	10	7	10	10	7	10	10	7	10	10
Y+R:	4.0	4.0	4.0	4.0	4.0	4.0	4.0	4.0	4.0	4.0	4.0	4.0
Volume Module: >> Count Date: 0 Jan 1900 << 12:00:00 AM												
Base Vol:	234	734	123	280	1113	1356	258	813	52	57	186	134
Growth Adj:	1.00	1.00	1.00	1.00	1.00	1.00	1.00	1.00	1.00	1.00	1.00	1.00
Initial Bse:	234	734	123	280	1113	1356	258	813	52	57	186	134
Added Vol:	0	3	0	0	18	0	0	0	0	0	0	0
PasserByVol:	0	0	0	0	0	0	0	0	0	0	0	0
Initial Fut:	234	737	123	280	1131	1356	258	813	52	57	186	134
User Adj:	1.00	1.00	1.00	1.00	1.00	1.00	1.00	1.00	1.00	1.00	1.00	1.00
PHF Adj:	1.00	1.00	1.00	1.00	1.00	1.00	1.00	1.00	1.00	1.00	1.00	1.00
PHF Volume:	234	737	123	280	1131	1356	258	813	52	57	186	134
Reduct Vol:	0	0	0	0	0	0	0	0	0	0	0	0
Reduced Vol:	234	737	123	280	1131	1356	258	813	52	57	186	134
PCE Adj:	1.00	1.00	1.00	1.00	1.00	1.00	1.00	1.00	1.00	1.00	1.00	1.00
MLF Adj:	1.00	1.00	1.00	1.00	1.00	1.00	1.00	1.00	1.00	1.00	1.00	1.00
Final Volume:	234	737	123	280	1131	1356	258	813	52	57	186	134
Saturation Flow Module:												
Sat/Lane:	1900	1900	1900	1900	1900	1900	1900	1900	1900	1900	1900	1900
Adjustment:	0.83	0.98	0.95	0.92	1.00	0.92	0.92	0.98	0.95	0.92	0.99	0.95
Lanes:	2.00	1.71	0.29	1.00	2.00	2.00	1.00	1.88	0.12	1.00	1.14	0.86
Final Sat.:	3150	3170	529	1750	3800	3500	1750	3477	222	1750	2149	1549
Capacity Analysis Module:												
Vol/Sat:	0.07	0.23	0.23	0.16	0.30	0.39	0.15	0.23	0.23	0.03	0.09	0.09
Crit Moves:	****					****		****		****		
Green Time:	8.7	31.8	31.8	21.9	45.1	45.1	20.4	27.2	27.2	7.0	13.8	13.8
Volume/Cap:	0.86	0.73	0.73	0.73	0.66	0.86	0.72	0.86	0.86	0.47	0.63	0.63
Delay/Veh:	67.9	32.6	32.6	43.3	21.9	27.4	44.3	42.1	42.1	47.5	43.1	43.1
User DelAdj:	1.00	1.00	1.00	1.00	1.00	1.00	1.00	1.00	1.00	1.00	1.00	1.00
AdjDel/Veh:	67.9	32.6	32.6	43.3	21.9	27.4	44.3	42.1	42.1	47.5	43.1	43.1
LOS by Move:	E	C-	C-	D	C+	C	D	D	D	D	D	D
HCM2kAvgQ:	5	12	12	10	14	23	10	16	16	2	6	6

Note: Queue reported is the number of cars per lane.

San Antonio Village Phase III MTA
 SJ21-2068
 Existing AM

Level Of Service Computation Report
 2000 HCM Unsignalized (Future Volume Alternative)
 Existing AM

Intersection #18: Project Driveway and San Antonio Road

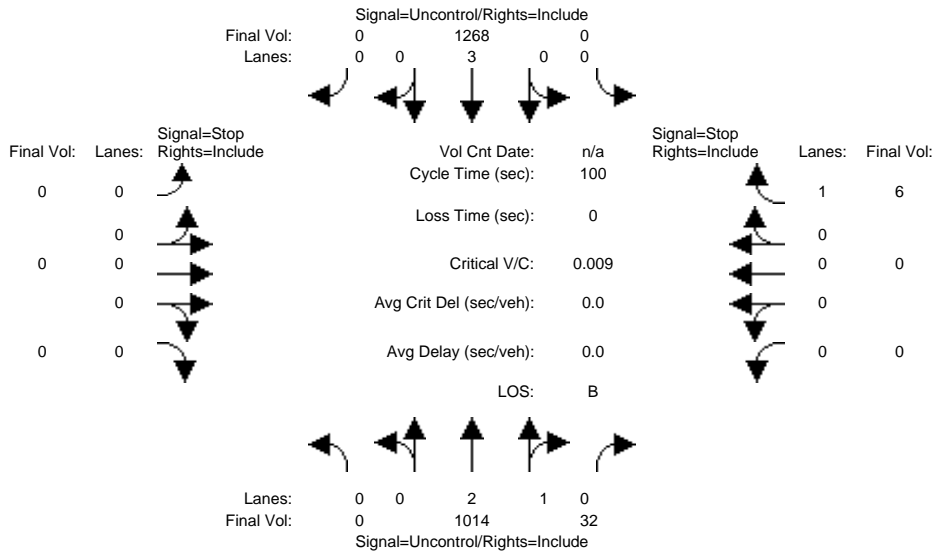

Approach:	North Bound			South Bound			East Bound			West Bound		
Movement:	L	T	R	L	T	R	L	T	R	L	T	R
Volume Module:												
Base Vol:	0	1014	32	0	1268	0	0	0	0	0	0	6
Growth Adj:	1.00	1.00	1.00	1.00	1.00	1.00	1.00	1.00	1.00	1.00	1.00	1.00
Initial Bse:	0	1014	32	0	1268	0	0	0	0	0	0	6
Added Vol:	0	0	0	0	0	0	0	0	0	0	0	0
PasserByVol:	0	0	0	0	0	0	0	0	0	0	0	0
Initial Fut:	0	1014	32	0	1268	0	0	0	0	0	0	6
User Adj:	1.00	1.00	1.00	1.00	1.00	1.00	1.00	1.00	1.00	1.00	1.00	1.00
PHF Adj:	1.00	1.00	1.00	1.00	1.00	1.00	1.00	1.00	1.00	1.00	1.00	1.00
PHF Volume:	0	1014	32	0	1268	0	0	0	0	0	0	6
Reduct Vol:	0	0	0	0	0	0	0	0	0	0	0	0
FinalVolume:	0	1014	32	0	1268	0	0	0	0	0	0	6
Critical Gap Module:												
Critical Gp:	xxxxx	xxxx	xxxxx	xxxxx	xxxx	xxxxx	xxxxx	xxxx	xxxxx	xxxxx	xxxx	6.9
FollowUpTim:	xxxxx	xxxx	xxxxx	xxxxx	xxxx	xxxxx	xxxxx	xxxx	xxxxx	xxxxx	xxxx	3.3
Capacity Module:												
Cnflct Vol:	xxxx	xxxx	xxxxx	xxxx	xxxx	xxxxx	xxxx	xxxx	xxxxx	xxxx	xxxx	354
Potent Cap.:	xxxx	xxxx	xxxxx	xxxx	xxxx	xxxxx	xxxx	xxxx	xxxxx	xxxx	xxxx	648
Move Cap.:	xxxx	xxxx	xxxxx	xxxx	xxxx	xxxxx	xxxx	xxxx	xxxxx	xxxx	xxxx	648
Volume/Cap:	xxxx	xxxx	xxxx	xxxx	xxxx	xxxx	xxxx	xxxx	xxxx	xxxx	xxxx	0.01
Level Of Service Module:												
2Way95thQ:	xxxx	xxxx	xxxxx	xxxx	xxxx	xxxxx	xxxx	xxxx	xxxxx	xxxx	xxxx	0.0
Control Del:	xxxxx	xxxx	xxxxx	xxxxx	xxxx	xxxxx	xxxxx	xxxx	xxxxx	xxxxx	xxxx	10.6
LOS by Move:	*	*	*	*	*	*	*	*	*	*	*	B
Movement:	LT	LTR	RT	LT	LTR	RT	LT	LTR	RT	LT	LTR	RT
Shared Cap.:	xxxx	xxxx	xxxxx	xxxx	xxxx	xxxxx	xxxx	xxxx	xxxxx	xxxx	xxxx	xxxxx
SharedQueue:	xxxxx	xxxx	xxxxx	xxxxx	xxxx	xxxxx	xxxxx	xxxx	xxxxx	xxxxx	xxxx	xxxxx
Shrd ConDel:	xxxxx	xxxx	xxxxx	xxxxx	xxxx	xxxxx	xxxxx	xxxx	xxxxx	xxxxx	xxxx	xxxxx
Shared LOS:	*	*	*	*	*	*	*	*	*	*	*	*
ApproachDel:	xxxxxxx			xxxxxxx			xxxxxxx					10.6
ApproachLOS:	*			*			*					B

Note: Queue reported is the number of cars per lane.

San Antonio Village Phase III MTA
SJ21-2068
Existing AM

Level Of Service Computation Report
2000 HCM Unsignalized (Future Volume Alternative)
Existing PP AM

Intersection #18: Project Driveway and San Antonio Road

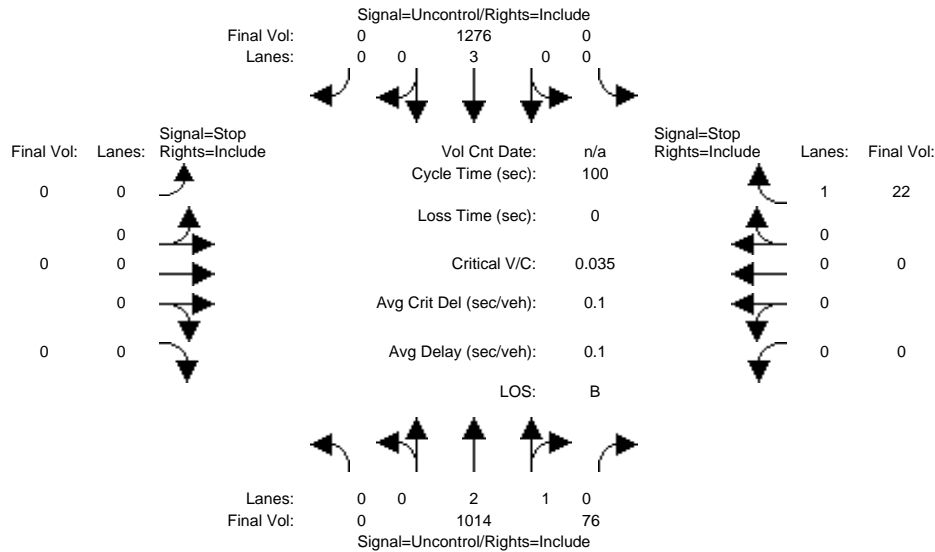

Approach:	North Bound			South Bound			East Bound			West Bound		
Movement:	L	T	R	L	T	R	L	T	R	L	T	R
Volume Module:												
Base Vol:	0	1014	32	0	1268	0	0	0	0	0	0	6
Growth Adj:	1.00	1.00	1.00	1.00	1.00	1.00	1.00	1.00	1.00	1.00	1.00	1.00
Initial Bse:	0	1014	32	0	1268	0	0	0	0	0	0	6
Added Vol:	0	0	44	0	8	0	0	0	0	0	0	16
PasserByVol:	0	0	0	0	0	0	0	0	0	0	0	0
Initial Fut:	0	1014	76	0	1276	0	0	0	0	0	0	22
User Adj:	1.00	1.00	1.00	1.00	1.00	1.00	1.00	1.00	1.00	1.00	1.00	1.00
PHF Adj:	1.00	1.00	1.00	1.00	1.00	1.00	1.00	1.00	1.00	1.00	1.00	1.00
PHF Volume:	0	1014	76	0	1276	0	0	0	0	0	0	22
Reduct Vol:	0	0	0	0	0	0	0	0	0	0	0	0
FinalVolume:	0	1014	76	0	1276	0	0	0	0	0	0	22
Critical Gap Module:												
Critical Gp:	xxxxx	xxxx	xxxxx	xxxxx	xxxx	xxxxx	xxxxx	xxxx	xxxxx	xxxxx	xxxx	6.9
FollowUpTim:	xxxxx	xxxx	xxxxx	xxxxx	xxxx	xxxxx	xxxxx	xxxx	xxxxx	xxxxx	xxxx	3.3
Capacity Module:												
Cnflct Vol:	xxxx	xxxx	xxxxx	xxxx	xxxx	xxxxx	xxxx	xxxx	xxxxx	xxxx	xxxx	376
Potent Cap.:	xxxx	xxxx	xxxxx	xxxx	xxxx	xxxxx	xxxx	xxxx	xxxxx	xxxx	xxxx	627
Move Cap.:	xxxx	xxxx	xxxxx	xxxx	xxxx	xxxxx	xxxx	xxxx	xxxxx	xxxx	xxxx	627
Volume/Cap:	xxxx	xxxx	xxxx	xxxx	xxxx	xxxx	xxxx	xxxx	xxxx	xxxx	xxxx	0.04
Level Of Service Module:												
2Way95thQ:	xxxx	xxxx	xxxxx	xxxx	xxxx	xxxxx	xxxx	xxxx	xxxxx	xxxx	xxxx	0.1
Control Del:	xxxxx	xxxx	xxxxx	xxxxx	xxxx	xxxxx	xxxxx	xxxx	xxxxx	xxxxx	xxxx	10.9
LOS by Move:	*	*	*	*	*	*	*	*	*	*	*	B
Movement:	LT	LTR	RT	LT	LTR	RT	LT	LTR	RT	LT	LTR	RT
Shared Cap.:	xxxx	xxxx	xxxxx	xxxx	xxxx	xxxxx	xxxx	xxxx	xxxxx	xxxx	xxxx	xxxxx
SharedQueue:	xxxxx	xxxx	xxxxx	xxxxx	xxxx	xxxxx	xxxxx	xxxx	xxxxx	xxxxx	xxxx	xxxxx
Shrd ConDel:	xxxxx	xxxx	xxxxx	xxxxx	xxxx	xxxxx	xxxxx	xxxx	xxxxx	xxxxx	xxxx	xxxxx
Shared LOS:	*	*	*	*	*	*	*	*	*	*	*	*
ApproachDel:	xxxxxxx			xxxxxxx			xxxxxxx			10.9		
ApproachLOS:	*			*			*			B		

Note: Queue reported is the number of cars per lane.

San Antonio Village Phase III MTA
 SJ21-2068
 Existing AM

Level Of Service Computation Report
 2000 HCM Unsignalized (Future Volume Alternative)
 Existing AM

Intersection #19: Project Driveway and California Street

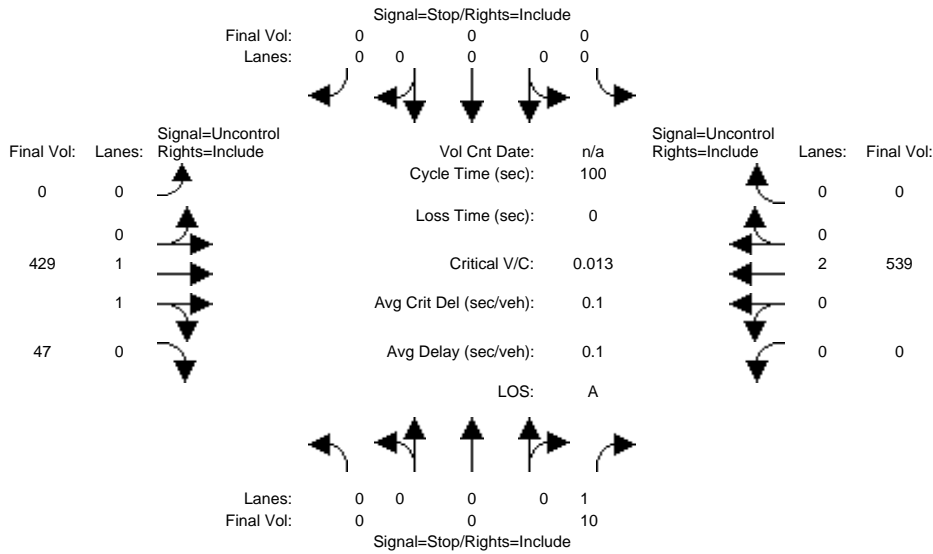

Approach:	North Bound			South Bound			East Bound			West Bound		
Movement:	L	T	R	L	T	R	L	T	R	L	T	R
Volume Module:												
Base Vol:	0	0	10	0	0	0	0	429	47	0	539	0
Growth Adj:	1.00	1.00	1.00	1.00	1.00	1.00	1.00	1.00	1.00	1.00	1.00	1.00
Initial Bse:	0	0	10	0	0	0	0	429	47	0	539	0
Added Vol:	0	0	0	0	0	0	0	0	0	0	0	0
PasserByVol:	0	0	0	0	0	0	0	0	0	0	0	0
Initial Fut:	0	0	10	0	0	0	0	429	47	0	539	0
User Adj:	1.00	1.00	1.00	1.00	1.00	1.00	1.00	1.00	1.00	1.00	1.00	1.00
PHF Adj:	1.00	1.00	1.00	1.00	1.00	1.00	1.00	1.00	1.00	1.00	1.00	1.00
PHF Volume:	0	0	10	0	0	0	0	429	47	0	539	0
Reduct Vol:	0	0	0	0	0	0	0	0	0	0	0	0
FinalVolume:	0	0	10	0	0	0	0	429	47	0	539	0
Critical Gap Module:												
Critical Gp:	xxxxx	xxxx	6.9	xxxxx	xxxx	xxxxx	xxxxx	xxxx	xxxxx	xxxxx	xxxx	xxxxx
FollowUpTim:	xxxxx	xxxx	3.3	xxxxx	xxxx	xxxxx	xxxxx	xxxx	xxxxx	xxxxx	xxxx	xxxxx
Capacity Module:												
Cnflct Vol:	xxxx	xxxx	238	xxxx	xxxx	xxxxx	xxxx	xxxx	xxxxx	xxxx	xxxx	xxxxx
Potent Cap.:	xxxx	xxxx	769	xxxx	xxxx	xxxxx	xxxx	xxxx	xxxxx	xxxx	xxxx	xxxxx
Move Cap.:	xxxx	xxxx	769	xxxx	xxxx	xxxxx	xxxx	xxxx	xxxxx	xxxx	xxxx	xxxxx
Volume/Cap:	xxxx	xxxx	0.01	xxxx	xxxx	xxxx	xxxx	xxxx	xxxx	xxxx	xxxx	xxxx
Level Of Service Module:												
2Way95thQ:	xxxx	xxxx	0.0	xxxx	xxxx	xxxxx	xxxx	xxxx	xxxxx	xxxx	xxxx	xxxxx
Control Del:	xxxxx	xxxx	9.7	xxxxx	xxxx	xxxxx	xxxxx	xxxx	xxxxx	xxxxx	xxxx	xxxxx
LOS by Move:	*	*	A	*	*	*	*	*	*	*	*	*
Movement:	LT	LTR	RT	LT	LTR	RT	LT	LTR	RT	LT	LTR	RT
Shared Cap.:	xxxx	xxxx	xxxxx	xxxx	xxxx	xxxxx	xxxx	xxxx	xxxxx	xxxx	xxxx	xxxxx
SharedQueue:	xxxxx	xxxx	xxxxx	xxxxx	xxxx	xxxxx	xxxxx	xxxx	xxxxx	xxxxx	xxxx	xxxxx
Shrd ConDel:	xxxxx	xxxx	xxxxx	xxxxx	xxxx	xxxxx	xxxxx	xxxx	xxxxx	xxxxx	xxxx	xxxxx
Shared LOS:	*	*	*	*	*	*	*	*	*	*	*	*
ApproachDel:	9.7			xxxxxxx			xxxxxxx			xxxxxxx		
ApproachLOS:	A			*			*			*		

Note: Queue reported is the number of cars per lane.

San Antonio Village Phase III MTA
 SJ21-2068
 Existing AM

Level Of Service Computation Report
 2000 HCM Unsignalized (Future Volume Alternative)
 Existing PP AM

Intersection #19: Project Driveway and California Street

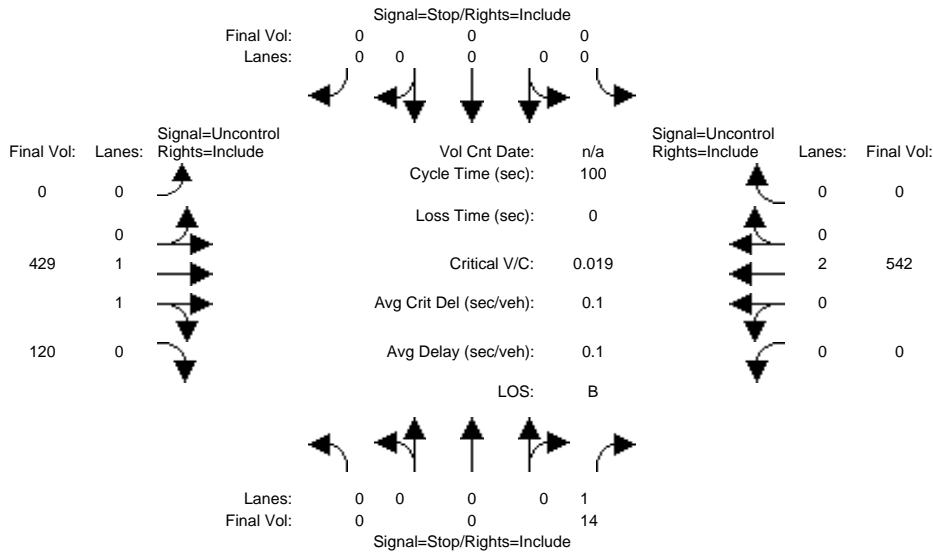

Approach:	North Bound			South Bound			East Bound			West Bound		
Movement:	L	T	R	L	T	R	L	T	R	L	T	R
Volume Module:												
Base Vol:	0	0	10	0	0	0	0	429	47	0	539	0
Growth Adj:	1.00	1.00	1.00	1.00	1.00	1.00	1.00	1.00	1.00	1.00	1.00	1.00
Initial Bse:	0	0	10	0	0	0	0	429	47	0	539	0
Added Vol:	0	0	4	0	0	0	0	0	73	0	3	0
PasserByVol:	0	0	0	0	0	0	0	0	0	0	0	0
Initial Fut:	0	0	14	0	0	0	0	429	120	0	542	0
User Adj:	1.00	1.00	1.00	1.00	1.00	1.00	1.00	1.00	1.00	1.00	1.00	1.00
PHF Adj:	1.00	1.00	1.00	1.00	1.00	1.00	1.00	1.00	1.00	1.00	1.00	1.00
PHF Volume:	0	0	14	0	0	0	0	429	120	0	542	0
Reduct Vol:	0	0	0	0	0	0	0	0	0	0	0	0
FinalVolume:	0	0	14	0	0	0	0	429	120	0	542	0
Critical Gap Module:												
Critical Gp:	xxxxx	xxxx	6.9	xxxxx	xxxx	xxxxx	xxxxx	xxxx	xxxxx	xxxxx	xxxx	xxxxx
FollowUpTim:	xxxxx	xxxx	3.3	xxxxx	xxxx	xxxxx	xxxxx	xxxx	xxxxx	xxxxx	xxxx	xxxxx
Capacity Module:												
Cnflct Vol:	xxxx	xxxx	275	xxxx	xxxx	xxxxx	xxxx	xxxx	xxxxx	xxxx	xxxx	xxxxx
Potent Cap.:	xxxx	xxxx	729	xxxx	xxxx	xxxxx	xxxx	xxxx	xxxxx	xxxx	xxxx	xxxxx
Move Cap.:	xxxx	xxxx	729	xxxx	xxxx	xxxxx	xxxx	xxxx	xxxxx	xxxx	xxxx	xxxxx
Volume/Cap:	xxxx	xxxx	0.02	xxxx	xxxx	xxxx	xxxx	xxxx	xxxx	xxxx	xxxx	xxxx
Level Of Service Module:												
2Way95thQ:	xxxx	xxxx	0.1	xxxx	xxxx	xxxxx	xxxx	xxxx	xxxxx	xxxx	xxxx	xxxxx
Control Del:	xxxxx	xxxx	10.0	xxxxx	xxxx	xxxxx	xxxxx	xxxx	xxxxx	xxxxx	xxxx	xxxxx
LOS by Move:	*	*	B	*	*	*	*	*	*	*	*	*
Movement:	LT	LTR	RT	LT	LTR	RT	LT	LTR	RT	LT	LTR	RT
Shared Cap.:	xxxx	xxxx	xxxxx	xxxx	xxxx	xxxxx	xxxx	xxxx	xxxxx	xxxx	xxxx	xxxxx
SharedQueue:	xxxxx	xxxx	xxxxx	xxxxx	xxxx	xxxxx	xxxxx	xxxx	xxxxx	xxxxx	xxxx	xxxxx
Shrd ConDel:	xxxxx	xxxx	xxxxx	xxxxx	xxxx	xxxxx	xxxxx	xxxx	xxxxx	xxxxx	xxxx	xxxxx
Shared LOS:	*	*	*	*	*	*	*	*	*	*	*	*
ApproachDel:	10.0			xxxxxxx			xxxxxxx			xxxxxxx		
ApproachLOS:	B			*			*			*		

Note: Queue reported is the number of cars per lane.

San Antonio Village Phase III MTA
 SJ21-2068
 Existing PM

Level Of Service Computation Report
 2000 HCM Operations (Future Volume Alternative)
 Existing PM

Intersection #1: El Camino Real and Arastradero Road-Charleston Road

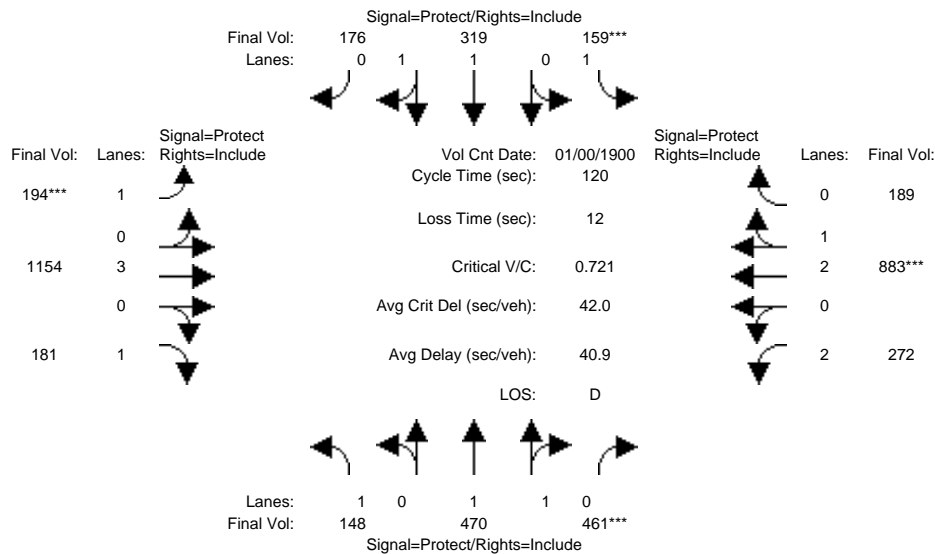

Approach:	North Bound			South Bound			East Bound			West Bound		
	L	T	R	L	T	R	L	T	R	L	T	R
Min. Green:	7	10	10	7	10	10	7	10	10	7	10	10
Y+R:	4.0	4.0	4.0	4.0	4.0	4.0	4.0	4.0	4.0	4.0	4.0	4.0

Volume Module:	>>	Count	Date:	0 Jan 1900	<<	12:00:00 AM						
Base Vol:	148	470	461	159	319	176	194	1154	181	272	883	189
Growth Adj:	1.00	1.00	1.00	1.00	1.00	1.00	1.00	1.00	1.00	1.00	1.00	1.00
Initial Bse:	148	470	461	159	319	176	194	1154	181	272	883	189
Added Vol:	0	0	0	0	0	0	0	0	0	0	0	0
PasserByVol:	0	0	0	0	0	0	0	0	0	0	0	0
Initial Fut:	148	470	461	159	319	176	194	1154	181	272	883	189
User Adj:	1.00	1.00	1.00	1.00	1.00	1.00	1.00	1.00	1.00	1.00	1.00	1.00
PHF Adj:	1.00	1.00	1.00	1.00	1.00	1.00	1.00	1.00	1.00	1.00	1.00	1.00
PHF Volume:	148	470	461	159	319	176	194	1154	181	272	883	189
Reduct Vol:	0	0	0	0	0	0	0	0	0	0	0	0
Reduced Vol:	148	470	461	159	319	176	194	1154	181	272	883	189
PCE Adj:	1.00	1.00	1.00	1.00	1.00	1.00	1.00	1.00	1.00	1.00	1.00	1.00
MLF Adj:	1.00	1.00	1.00	1.00	1.00	1.00	1.00	1.00	1.00	1.00	1.00	1.00
Final Volume:	148	470	461	159	319	176	194	1154	181	272	883	189

Saturation Flow Module:												
Sat/Lane:	1900	1900	1900	1900	1900	1900	1900	1900	1900	1900	1900	1900
Adjustment:	0.92	1.00	0.95	0.92	0.99	0.95	0.92	1.00	0.92	0.83	0.99	0.95
Lanes:	1.00	1.00	1.00	1.00	1.27	0.73	1.00	3.00	1.00	2.00	2.45	0.55
Final Sat.:	1750	1899	1800	1750	2383	1315	1750	5700	1750	3150	4611	987

Capacity Analysis Module:												
Vol/Sat:	0.08	0.25	0.26	0.09	0.13	0.13	0.11	0.20	0.10	0.09	0.19	0.19
Crit Moves:			****	****			****				****	
Green Time:	22.3	42.6	42.6	15.1	35.4	35.4	18.4	35.3	35.3	15.0	31.8	31.8
Volume/Cap:	0.45	0.70	0.72	0.72	0.45	0.45	0.72	0.69	0.35	0.69	0.72	0.72
Uniform Del:	43.4	33.2	33.6	50.4	34.5	34.5	48.3	37.5	33.4	50.2	40.0	40.0
IncrementDel:	1.0	1.6	2.0	11.1	0.3	0.3	9.2	1.2	0.4	5.1	1.8	1.8
InitQueueDel:	0.0	0.0	0.0	0.0	0.0	0.0	0.0	0.0	0.0	0.0	0.0	0.0
Delay Adj:	1.00	1.00	1.00	1.00	1.00	1.00	1.00	1.00	1.00	1.00	1.00	1.00
Delay/Veh:	44.4	34.8	35.6	61.5	34.8	34.8	57.5	38.8	33.8	55.3	41.8	41.8
User DelAdj:	1.00	1.00	1.00	1.00	1.00	1.00	1.00	1.00	1.00	1.00	1.00	1.00
AdjDel/Veh:	44.4	34.8	35.6	61.5	34.8	34.8	57.5	38.8	33.8	55.3	41.8	41.8
LOS by Move:	D	C-	D+	E	C-	C-	E+	D+	C-	E+	D	D
HCM2kAvgQ:	6	16	16	8	8	8	9	13	6	7	13	13

Note: Queue reported is the number of cars per lane.

San Antonio Village Phase III MTA
 SJ21-2068
 Existing PM

Level Of Service Computation Report
 2000 HCM Operations (Future Volume Alternative)
 Existing PP PM

Intersection #1: El Camino Real and Arastradero Road-Charleston Road

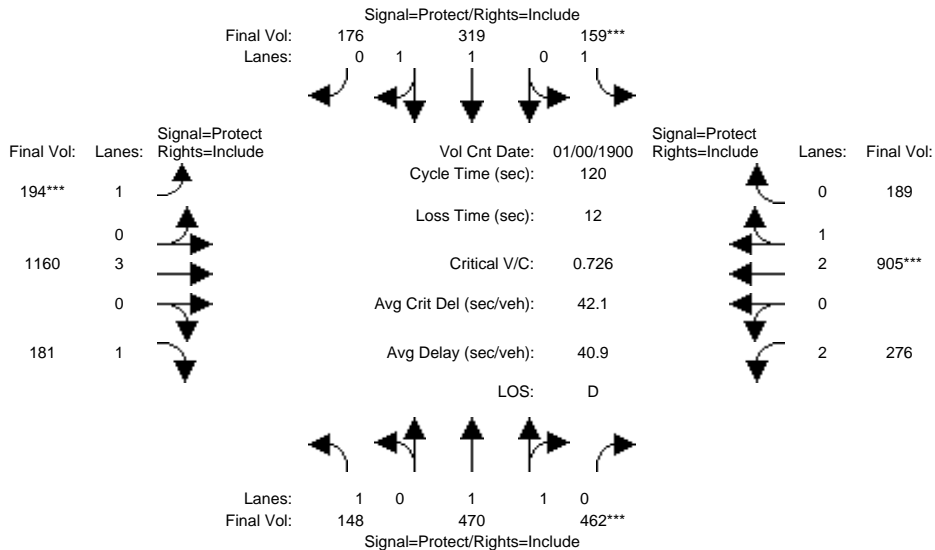

Approach:	North Bound			South Bound			East Bound			West Bound		
	L	T	R	L	T	R	L	T	R	L	T	R
Min. Green:	7	10	10	7	10	10	7	10	10	7	10	10
Y+R:	4.0	4.0	4.0	4.0	4.0	4.0	4.0	4.0	4.0	4.0	4.0	4.0
Volume Module: >> Count Date: 0 Jan 1900 << 12:00:00 AM												
Base Vol:	148	470	461	159	319	176	194	1154	181	272	883	189
Growth Adj:	1.00	1.00	1.00	1.00	1.00	1.00	1.00	1.00	1.00	1.00	1.00	1.00
Initial Bse:	148	470	461	159	319	176	194	1154	181	272	883	189
Added Vol:	0	0	1	0	0	0	0	6	0	4	22	0
PasserByVol:	0	0	0	0	0	0	0	0	0	0	0	0
Initial Fut:	148	470	462	159	319	176	194	1160	181	276	905	189
User Adj:	1.00	1.00	1.00	1.00	1.00	1.00	1.00	1.00	1.00	1.00	1.00	1.00
PHF Adj:	1.00	1.00	1.00	1.00	1.00	1.00	1.00	1.00	1.00	1.00	1.00	1.00
PHF Volume:	148	470	462	159	319	176	194	1160	181	276	905	189
Reduct Vol:	0	0	0	0	0	0	0	0	0	0	0	0
Reduced Vol:	148	470	462	159	319	176	194	1160	181	276	905	189
PCE Adj:	1.00	1.00	1.00	1.00	1.00	1.00	1.00	1.00	1.00	1.00	1.00	1.00
MLF Adj:	1.00	1.00	1.00	1.00	1.00	1.00	1.00	1.00	1.00	1.00	1.00	1.00
FinalVolume:	148	470	462	159	319	176	194	1160	181	276	905	189
Saturation Flow Module:												
Sat/Lane:	1900	1900	1900	1900	1900	1900	1900	1900	1900	1900	1900	1900
Adjustment:	0.92	1.00	0.95	0.92	0.99	0.95	0.92	1.00	0.92	0.83	0.99	0.95
Lanes:	1.00	1.00	1.00	1.00	1.27	0.73	1.00	3.00	1.00	2.00	2.46	0.54
Final Sat.:	1750	1899	1800	1750	2383	1315	1750	5700	1750	3150	4631	967
Capacity Analysis Module:												
Vol/Sat:	0.08	0.25	0.26	0.09	0.13	0.13	0.11	0.20	0.10	0.09	0.20	0.20
Crit Moves:			****	****			****				****	
Green Time:	22.2	42.4	42.4	15.0	35.2	35.2	18.3	35.4	35.4	15.2	32.3	32.3
Volume/Cap:	0.46	0.70	0.73	0.73	0.46	0.46	0.73	0.69	0.35	0.69	0.73	0.73
Delay/Veh:	44.5	35.0	35.9	62.0	34.9	34.9	58.0	38.7	33.7	55.2	41.7	41.7
User DelAdj:	1.00	1.00	1.00	1.00	1.00	1.00	1.00	1.00	1.00	1.00	1.00	1.00
AdjDel/Veh:	44.5	35.0	35.9	62.0	34.9	34.9	58.0	38.7	33.7	55.2	41.7	41.7
LOS by Move:	D	D+	D+	E	C-	C-	E+	D+	C-	E+	D	D
HCM2kAvgQ:	6	16	17	8	8	8	9	13	6	7	14	14

Note: Queue reported is the number of cars per lane.

San Antonio Village Phase III MTA
 SJ21-2068
 Existing PM

Level Of Service Computation Report
 2000 HCM Operations (Future Volume Alternative)
 Existing PM

Intersection #2: El Camino Real and Del Medio Avenue

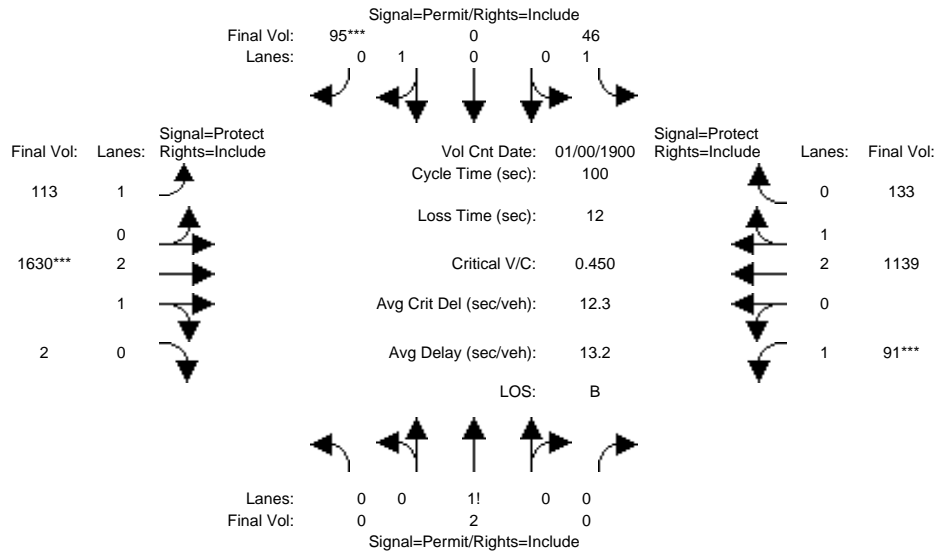

Approach:	North Bound			South Bound			East Bound			West Bound		
	L	T	R	L	T	R	L	T	R	L	T	R
Min. Green:	10	10	10	10	10	10	7	10	10	7	10	10
Y+R:	4.0	4.0	4.0	4.0	4.0	4.0	4.0	4.0	4.0	4.0	4.0	4.0

Volume Module:	>> Count Date: 0 Jan 1900 << 12:00:00 AM											
Base Vol:	0	2	0	46	0	95	113	1630	2	91	1139	133
Growth Adj:	1.00	1.00	1.00	1.00	1.00	1.00	1.00	1.00	1.00	1.00	1.00	1.00
Initial Bse:	0	2	0	46	0	95	113	1630	2	91	1139	133
Added Vol:	0	0	0	0	0	0	0	0	0	0	0	0
PasserByVol:	0	0	0	0	0	0	0	0	0	0	0	0
Initial Fut:	0	2	0	46	0	95	113	1630	2	91	1139	133
User Adj:	1.00	1.00	1.00	1.00	1.00	1.00	1.00	1.00	1.00	1.00	1.00	1.00
PHF Adj:	1.00	1.00	1.00	1.00	1.00	1.00	1.00	1.00	1.00	1.00	1.00	1.00
PHF Volume:	0	2	0	46	0	95	113	1630	2	91	1139	133
Reduct Vol:	0	0	0	0	0	0	0	0	0	0	0	0
Reduced Vol:	0	2	0	46	0	95	113	1630	2	91	1139	133
PCE Adj:	1.00	1.00	1.00	1.00	1.00	1.00	1.00	1.00	1.00	1.00	1.00	1.00
MLF Adj:	1.00	1.00	1.00	1.00	1.00	1.00	1.00	1.00	1.00	1.00	1.00	1.00
FinalVolume:	0	2	0	46	0	95	113	1630	2	91	1139	133

Saturation Flow Module:												
Sat/Lane:	1900	1900	1900	1900	1900	1900	1900	1900	1900	1900	1900	1900
Adjustment:	0.92	1.00	0.92	0.92	1.00	0.95	0.92	0.98	0.95	0.92	0.99	0.95
Lanes:	0.00	1.00	0.00	1.00	0.00	1.00	1.00	2.99	0.01	1.00	2.67	0.33
Final Sat.:	0	1900	0	1750	0	1800	1750	5593	7	1750	5014	585

Capacity Analysis Module:												
Vol/Sat:	0.00	0.00	0.00	0.03	0.00	0.05	0.06	0.29	0.29	0.05	0.23	0.23
Crit Moves:						****		****			****	
Green Time:	0.0	11.7	0.0	11.7	0.0	11.7	18.0	64.7	64.7	11.5	58.3	58.3
Volume/Cap:	0.00	0.01	0.00	0.22	0.00	0.45	0.36	0.45	0.45	0.45	0.39	0.39
Uniform Del:	0.0	39.0	0.0	40.0	0.0	41.1	36.0	8.8	8.8	41.3	11.2	11.2
IncrcmntDel:	0.0	0.0	0.0	0.6	0.0	1.5	0.7	0.1	0.1	1.6	0.1	0.1
InitQueuDel:	0.0	0.0	0.0	0.0	0.0	0.0	0.0	0.0	0.0	0.0	0.0	0.0
Delay Adj:	0.00	1.00	0.00	1.00	0.00	1.00	1.00	1.00	1.00	1.00	1.00	1.00
Delay/Veh:	0.0	39.0	0.0	40.6	0.0	42.7	36.7	8.9	8.9	42.9	11.3	11.3
User DelAdj:	1.00	1.00	1.00	1.00	1.00	1.00	1.00	1.00	1.00	1.00	1.00	1.00
AdjDel/Veh:	0.0	39.0	0.0	40.6	0.0	42.7	36.7	8.9	8.9	42.9	11.3	11.3
LOS by Move:	A	D	A	D	A	D	D+	A	A	D	B+	B+
HCM2kAvgQ:	0	0	0	2	0	3	4	8	8	3	7	7

Note: Queue reported is the number of cars per lane.

San Antonio Village Phase III MTA
 SJ21-2068
 Existing PM

Level Of Service Computation Report
 2000 HCM Operations (Future Volume Alternative)
 Existing PP PM

Intersection #2: El Camino Real and Del Medio Avenue

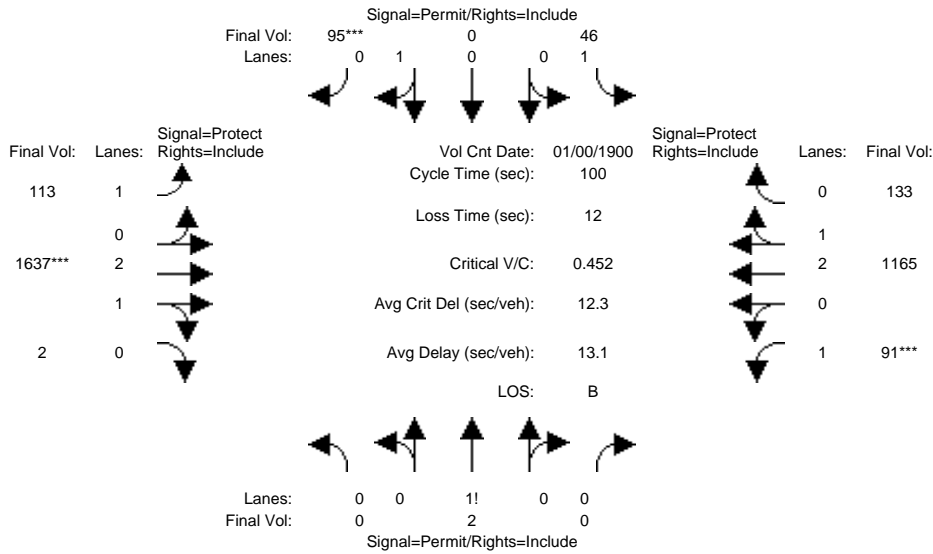

Approach:	North Bound			South Bound			East Bound			West Bound		
	L	T	R	L	T	R	L	T	R	L	T	R
Min. Green:	10	10	10	10	10	10	7	10	10	7	10	10
Y+R:	4.0	4.0	4.0	4.0	4.0	4.0	4.0	4.0	4.0	4.0	4.0	4.0
Volume Module: >> Count Date: 0 Jan 1900 << 12:00:00 AM												
Base Vol:	0	2	0	46	0	95	113	1630	2	91	1139	133
Growth Adj:	1.00	1.00	1.00	1.00	1.00	1.00	1.00	1.00	1.00	1.00	1.00	1.00
Initial Bse:	0	2	0	46	0	95	113	1630	2	91	1139	133
Added Vol:	0	0	0	0	0	0	0	7	0	0	26	0
PasserByVol:	0	0	0	0	0	0	0	0	0	0	0	0
Initial Fut:	0	2	0	46	0	95	113	1637	2	91	1165	133
User Adj:	1.00	1.00	1.00	1.00	1.00	1.00	1.00	1.00	1.00	1.00	1.00	1.00
PHF Adj:	1.00	1.00	1.00	1.00	1.00	1.00	1.00	1.00	1.00	1.00	1.00	1.00
PHF Volume:	0	2	0	46	0	95	113	1637	2	91	1165	133
Reduct Vol:	0	0	0	0	0	0	0	0	0	0	0	0
Reduced Vol:	0	2	0	46	0	95	113	1637	2	91	1165	133
PCE Adj:	1.00	1.00	1.00	1.00	1.00	1.00	1.00	1.00	1.00	1.00	1.00	1.00
MLF Adj:	1.00	1.00	1.00	1.00	1.00	1.00	1.00	1.00	1.00	1.00	1.00	1.00
FinalVolume:	0	2	0	46	0	95	113	1637	2	91	1165	133
Saturation Flow Module:												
Sat/Lane:	1900	1900	1900	1900	1900	1900	1900	1900	1900	1900	1900	1900
Adjustment:	0.92	1.00	0.92	0.92	1.00	0.95	0.92	0.98	0.95	0.92	0.99	0.95
Lanes:	0.00	1.00	0.00	1.00	0.00	1.00	1.00	2.99	0.01	1.00	2.68	0.32
Final Sat.:	0	1900	0	1750	0	1800	1750	5593	7	1750	5025	574
Capacity Analysis Module:												
Vol/Sat:	0.00	0.00	0.00	0.03	0.00	0.05	0.06	0.29	0.29	0.05	0.23	0.23
Crit Moves:				****			****			****		
Green Time:	0.0	11.7	0.0	11.7	0.0	11.7	17.7	64.8	64.8	11.5	58.6	58.6
Volume/Cap:	0.00	0.01	0.00	0.22	0.00	0.45	0.36	0.45	0.45	0.45	0.40	0.40
Delay/Veh:	0.0	39.1	0.0	40.6	0.0	42.7	36.9	8.8	8.8	42.9	11.2	11.2
User DelAdj:	1.00	1.00	1.00	1.00	1.00	1.00	1.00	1.00	1.00	1.00	1.00	1.00
AdjDel/Veh:	0.0	39.1	0.0	40.6	0.0	42.7	36.9	8.8	8.8	42.9	11.2	11.2
LOS by Move:	A	D	A	D	A	D	D+	A	A	D	B+	B+
HCM2kAvgQ:	0	0	0	2	0	3	4	9	9	3	7	7

Note: Queue reported is the number of cars per lane.

San Antonio Village Phase III MTA
 SJ21-2068
 Existing PM

Level Of Service Computation Report
 2000 HCM Operations (Future Volume Alternative)
 Existing PM

Intersection #3: El Camino Real and San Antonio Road

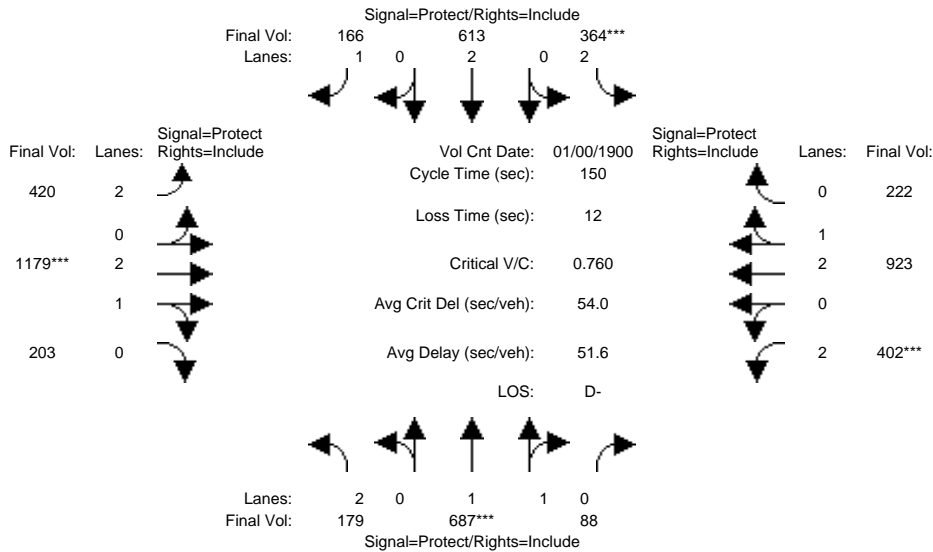

Approach:	North Bound			South Bound			East Bound			West Bound		
	L	T	R	L	T	R	L	T	R	L	T	R
Min. Green:	10	30	0	10	30	0	10	28	0	10	28	0
Y+R:	4.0	4.0	4.0	4.0	4.0	4.0	4.0	4.0	4.0	4.0	4.0	4.0
Volume Module: >> Count Date: 0 Jan 1900 << 12:00:00 AM												
Base Vol:	179	687	88	364	613	166	420	1179	203	402	923	222
Growth Adj:	1.00	1.00	1.00	1.00	1.00	1.00	1.00	1.00	1.00	1.00	1.00	1.00
Initial Bse:	179	687	88	364	613	166	420	1179	203	402	923	222
Added Vol:	0	0	0	0	0	0	0	0	0	0	0	0
PasserByVol:	0	0	0	0	0	0	0	0	0	0	0	0
Initial Fut:	179	687	88	364	613	166	420	1179	203	402	923	222
User Adj:	1.00	1.00	1.00	1.00	1.00	1.00	1.00	1.00	1.00	1.00	1.00	1.00
PHF Adj:	1.00	1.00	1.00	1.00	1.00	1.00	1.00	1.00	1.00	1.00	1.00	1.00
PHF Volume:	179	687	88	364	613	166	420	1179	203	402	923	222
Reduct Vol:	0	0	0	0	0	0	0	0	0	0	0	0
Reduced Vol:	179	687	88	364	613	166	420	1179	203	402	923	222
PCE Adj:	1.00	1.00	1.00	1.00	1.00	1.00	1.00	1.00	1.00	1.00	1.00	1.00
MLF Adj:	1.00	1.00	1.00	1.00	1.00	1.00	1.00	1.00	1.00	1.00	1.00	1.00
FinalVolume:	179	687	88	364	613	166	420	1179	203	402	923	222
Saturation Flow Module:												
Sat/Lane:	1900	1900	1900	1900	1900	1900	1900	1900	1900	1900	1900	1900
Adjustment:	0.83	0.98	0.95	0.83	1.00	0.92	0.83	0.99	0.95	0.83	0.99	0.95
Lanes:	2.00	1.77	0.23	2.00	2.00	1.00	2.00	2.54	0.46	2.00	2.40	0.60
Final Sat.:	3150	3280	420	3150	3800	1750	3150	4776	822	3150	4513	1085
Capacity Analysis Module:												
Vol/Sat:	0.06	0.21	0.21	0.12	0.16	0.09	0.13	0.25	0.25	0.13	0.20	0.20
Crit Moves:	****			****			****			****		
Green Time:	16.0	41.3	41.3	22.8	48.1	48.1	29.2	48.7	48.7	25.2	44.7	44.7
Volume/Cap:	0.53	0.76	0.76	0.76	0.50	0.30	0.69	0.76	0.76	0.76	0.69	0.69
Uniform Del:	63.4	49.8	49.8	61.0	41.3	38.2	56.2	45.4	45.4	59.5	46.4	46.4
IncrcmntDel:	1.6	3.4	3.4	7.0	0.3	0.3	3.3	1.9	1.9	6.4	1.2	1.2
InitQueuDel:	0.0	0.0	0.0	0.0	0.0	0.0	0.0	0.0	0.0	0.0	0.0	0.0
Delay Adj:	1.00	1.00	1.00	1.00	1.00	1.00	1.00	1.00	1.00	1.00	1.00	1.00
Delay/Veh:	65.1	53.2	53.2	68.0	41.6	38.5	59.4	47.3	47.3	65.9	47.7	47.7
User DelAdj:	1.00	1.00	1.00	1.00	1.00	1.00	1.00	1.00	1.00	1.00	1.00	1.00
AdjDel/Veh:	65.1	53.2	53.2	68.0	41.6	38.5	59.4	47.3	47.3	65.9	47.7	47.7
LOS by Move:	E	D-	D-	E	D	D+	E+	D	D	E	D	D
HCM2kAvgQ:	5	18	18	10	11	6	11	19	19	12	16	16

Note: Queue reported is the number of cars per lane.

San Antonio Village Phase III MTA
 SJ21-2068
 Existing PM

Level Of Service Computation Report
 2000 HCM Operations (Future Volume Alternative)
 Existing PP PM

Intersection #3: El Camino Real and San Antonio Road

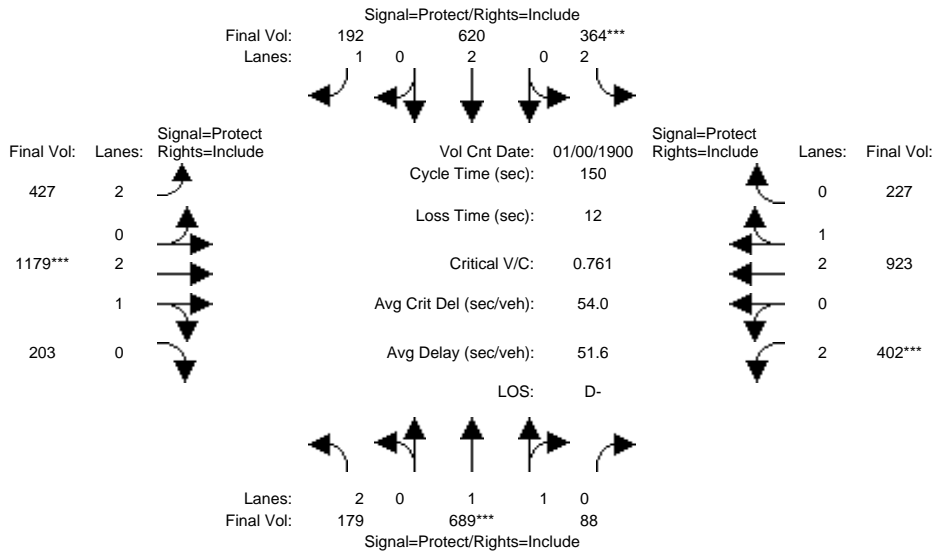

Approach:	North Bound			South Bound			East Bound			West Bound		
	L	T	R	L	T	R	L	T	R	L	T	R
Min. Green:	10	30	0	10	30	0	10	28	0	10	28	0
Y+R:	4.0	4.0	4.0	4.0	4.0	4.0	4.0	4.0	4.0	4.0	4.0	4.0
Volume Module: >> Count Date: 0 Jan 1900 << 12:00:00 AM												
Base Vol:	179	687	88	364	613	166	420	1179	203	402	923	222
Growth Adj:	1.00	1.00	1.00	1.00	1.00	1.00	1.00	1.00	1.00	1.00	1.00	1.00
Initial Bse:	179	687	88	364	613	166	420	1179	203	402	923	222
Added Vol:	0	2	0	0	7	26	7	0	0	0	0	5
PasserByVol:	0	0	0	0	0	0	0	0	0	0	0	0
Initial Fut:	179	689	88	364	620	192	427	1179	203	402	923	227
User Adj:	1.00	1.00	1.00	1.00	1.00	1.00	1.00	1.00	1.00	1.00	1.00	1.00
PHF Adj:	1.00	1.00	1.00	1.00	1.00	1.00	1.00	1.00	1.00	1.00	1.00	1.00
PHF Volume:	179	689	88	364	620	192	427	1179	203	402	923	227
Reduct Vol:	0	0	0	0	0	0	0	0	0	0	0	0
Reduced Vol:	179	689	88	364	620	192	427	1179	203	402	923	227
PCE Adj:	1.00	1.00	1.00	1.00	1.00	1.00	1.00	1.00	1.00	1.00	1.00	1.00
MLF Adj:	1.00	1.00	1.00	1.00	1.00	1.00	1.00	1.00	1.00	1.00	1.00	1.00
Final Volume:	179	689	88	364	620	192	427	1179	203	402	923	227
Saturation Flow Module:												
Sat/Lane:	1900	1900	1900	1900	1900	1900	1900	1900	1900	1900	1900	1900
Adjustment:	0.83	0.98	0.95	0.83	1.00	0.92	0.83	0.99	0.95	0.83	0.99	0.95
Lanes:	2.00	1.77	0.23	2.00	2.00	1.00	2.00	2.54	0.46	2.00	2.39	0.61
Final Sat.:	3150	3281	419	3150	3800	1750	3150	4776	822	3150	4493	1105
Capacity Analysis Module:												
Vol/Sat:	0.06	0.21	0.21	0.12	0.16	0.11	0.14	0.25	0.25	0.13	0.21	0.21
Crit Moves:	****			****			****			****		
Green Time:	16.0	41.4	41.4	22.8	48.1	48.1	29.3	48.7	48.7	25.2	44.5	44.5
Volume/Cap:	0.53	0.76	0.76	0.76	0.51	0.34	0.69	0.76	0.76	0.76	0.69	0.69
Delay/Veh:	65.0	53.2	53.2	68.0	41.7	39.2	59.5	47.4	47.4	66.0	48.0	48.0
User DelAdj:	1.00	1.00	1.00	1.00	1.00	1.00	1.00	1.00	1.00	1.00	1.00	1.00
AdjDel/Veh:	65.0	53.2	53.2	68.0	41.7	39.2	59.5	47.4	47.4	66.0	48.0	48.0
LOS by Move:	E	D-	D-	E	D	D	E+	D	D	E	D	D
HCM2kAvgQ:	5	18	18	10	11	7	11	19	19	12	16	16

Note: Queue reported is the number of cars per lane.

San Antonio Village Phase III MTA
 SJ21-2068
 Existing PM

Level Of Service Computation Report
 2000 HCM Operations (Future Volume Alternative)
 Existing PM

Intersection #4: El Camino Real and Showers Drive

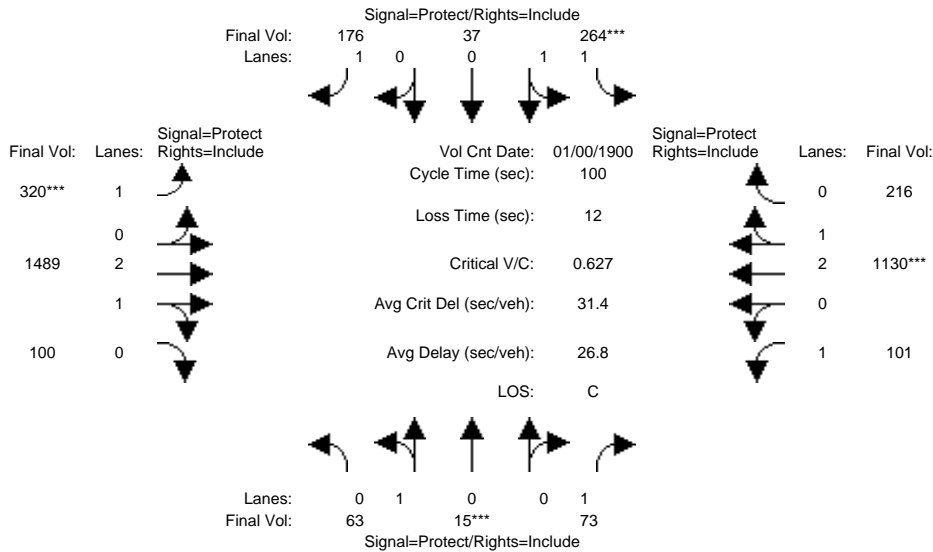

Approach:	North Bound			South Bound			East Bound			West Bound		
	L	T	R	L	T	R	L	T	R	L	T	R
Min. Green:	7	10	10	7	10	10	7	10	10	7	10	10
Y+R:	4.0	4.0	4.0	4.0	4.0	4.0	4.0	4.0	4.0	4.0	4.0	4.0
Volume Module: >> Count Date: 0 Jan 1900 << 12:00:00 AM												
Base Vol:	63	15	73	264	37	176	320	1489	100	101	1130	216
Growth Adj:	1.00	1.00	1.00	1.00	1.00	1.00	1.00	1.00	1.00	1.00	1.00	1.00
Initial Bse:	63	15	73	264	37	176	320	1489	100	101	1130	216
Added Vol:	0	0	0	0	0	0	0	0	0	0	0	0
PasserByVol:	0	0	0	0	0	0	0	0	0	0	0	0
Initial Fut:	63	15	73	264	37	176	320	1489	100	101	1130	216
User Adj:	1.00	1.00	1.00	1.00	1.00	1.00	1.00	1.00	1.00	1.00	1.00	1.00
PHF Adj:	1.00	1.00	1.00	1.00	1.00	1.00	1.00	1.00	1.00	1.00	1.00	1.00
PHF Volume:	63	15	73	264	37	176	320	1489	100	101	1130	216
Reduct Vol:	0	0	0	0	0	0	0	0	0	0	0	0
Reduced Vol:	63	15	73	264	37	176	320	1489	100	101	1130	216
PCE Adj:	1.00	1.00	1.00	1.00	1.00	1.00	1.00	1.00	1.00	1.00	1.00	1.00
MLF Adj:	1.00	1.00	1.00	1.00	1.00	1.00	1.00	1.00	1.00	1.00	1.00	1.00
FinalVolume:	63	15	73	264	37	176	320	1489	100	101	1130	216
Saturation Flow Module:												
Sat/Lane:	1900	1900	1900	1900	1900	1900	1900	1900	1900	1900	1900	1900
Adjustment:	0.95	0.95	0.92	0.93	0.95	0.92	0.92	0.98	0.95	0.92	0.99	0.95
Lanes:	0.81	0.19	1.00	1.76	0.24	1.00	1.00	2.80	0.20	1.00	2.50	0.50
Final Sat.:	1454	346	1750	3114	436	1750	1750	5247	352	1750	4700	898
Capacity Analysis Module:												
Vol/Sat:	0.04	0.04	0.04	0.08	0.08	0.10	0.18	0.28	0.28	0.06	0.24	0.24
Crit Moves:	****	****	****	****	****	****	****	****	****	****	****	****
Green Time:	9.4	10.0	10.0	13.0	13.6	13.6	28.1	52.1	52.1	12.9	36.9	36.9
Volume/Cap:	0.46	0.43	0.42	0.65	0.62	0.74	0.65	0.54	0.54	0.45	0.65	0.65
Uniform Del:	42.9	42.3	42.3	41.3	40.8	41.5	31.7	16.0	16.0	40.3	26.2	26.2
IncrcmntDel:	2.0	1.7	1.6	3.3	2.6	11.8	3.1	0.2	0.2	1.4	0.7	0.7
InitQueuDel:	0.0	0.0	0.0	0.0	0.0	0.0	0.0	0.0	0.0	0.0	0.0	0.0
Delay Adj:	1.00	1.00	1.00	1.00	1.00	1.00	1.00	1.00	1.00	1.00	1.00	1.00
Delay/Veh:	44.8	44.0	43.9	44.6	43.4	53.3	34.8	16.2	16.2	41.7	26.9	26.9
User DelAdj:	1.00	1.00	1.00	1.00	1.00	1.00	1.00	1.00	1.00	1.00	1.00	1.00
AdjDel/Veh:	44.8	44.0	43.9	44.6	43.4	53.3	34.8	16.2	16.2	41.7	26.9	26.9
LOS by Move:	D	D	D	D	D	D-	C-	B	B	D	C	C
HCM2kAvgQ:	3	3	3	5	5	6	10	11	11	4	12	12

Note: Queue reported is the number of cars per lane.

San Antonio Village Phase III MTA
 SJ21-2068
 Existing PM

Level Of Service Computation Report
 2000 HCM Operations (Future Volume Alternative)
 Existing PP PM

Intersection #4: El Camino Real and Showers Drive

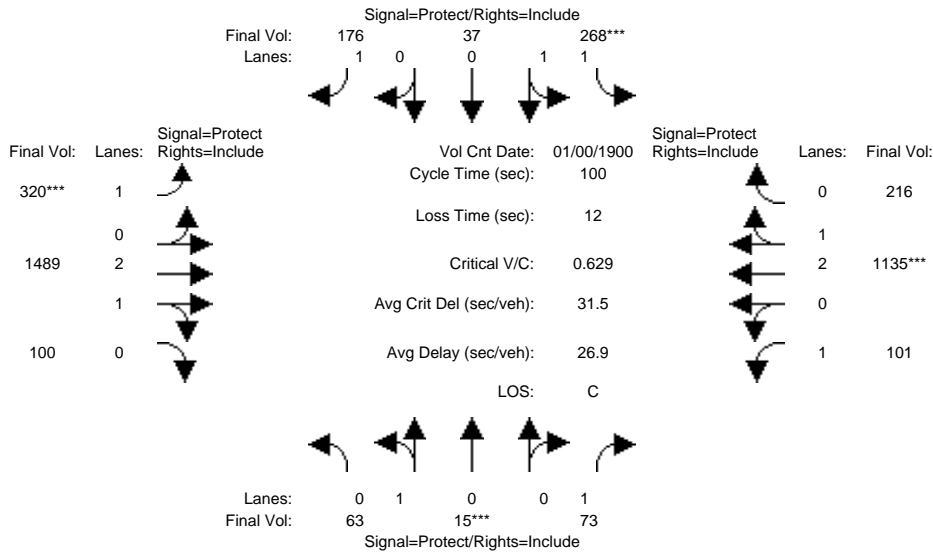

Approach:	North Bound			South Bound			East Bound			West Bound		
	L	T	R	L	T	R	L	T	R	L	T	R
Min. Green:	7	10	10	7	10	10	7	10	10	7	10	10
Y+R:	4.0	4.0	4.0	4.0	4.0	4.0	4.0	4.0	4.0	4.0	4.0	4.0

Volume Module:	>> Count Date: 0 Jan 1900 << 12:00:00 AM											
Base Vol:	63	15	73	264	37	176	320	1489	100	101	1130	216
Growth Adj:	1.00	1.00	1.00	1.00	1.00	1.00	1.00	1.00	1.00	1.00	1.00	1.00
Initial Bse:	63	15	73	264	37	176	320	1489	100	101	1130	216
Added Vol:	0	0	0	4	0	0	0	0	0	0	5	0
PasserByVol:	0	0	0	0	0	0	0	0	0	0	0	0
Initial Fut:	63	15	73	268	37	176	320	1489	100	101	1135	216
User Adj:	1.00	1.00	1.00	1.00	1.00	1.00	1.00	1.00	1.00	1.00	1.00	1.00
PHF Adj:	1.00	1.00	1.00	1.00	1.00	1.00	1.00	1.00	1.00	1.00	1.00	1.00
PHF Volume:	63	15	73	268	37	176	320	1489	100	101	1135	216
Reduct Vol:	0	0	0	0	0	0	0	0	0	0	0	0
Reduced Vol:	63	15	73	268	37	176	320	1489	100	101	1135	216
PCE Adj:	1.00	1.00	1.00	1.00	1.00	1.00	1.00	1.00	1.00	1.00	1.00	1.00
MLF Adj:	1.00	1.00	1.00	1.00	1.00	1.00	1.00	1.00	1.00	1.00	1.00	1.00
FinalVolume:	63	15	73	268	37	176	320	1489	100	101	1135	216

Saturation Flow Module:												
Sat/Lane:	1900	1900	1900	1900	1900	1900	1900	1900	1900	1900	1900	1900
Adjustment:	0.95	0.95	0.92	0.93	0.95	0.92	0.92	0.98	0.95	0.92	0.99	0.95
Lanes:	0.81	0.19	1.00	1.76	0.24	1.00	1.00	2.80	0.20	1.00	2.50	0.50
Final Sat.:	1454	346	1750	3119	431	1750	1750	5247	352	1750	4703	895

Capacity Analysis Module:												
Vol/Sat:	0.04	0.04	0.04	0.09	0.09	0.10	0.18	0.28	0.28	0.06	0.24	0.24
Crit Moves:	****	****	****	****	****	****	****	****	****	****	****	****
Green Time:	9.5	10.0	10.0	13.1	13.6	13.6	28.0	52.0	52.0	12.8	36.9	36.9
Volume/Cap:	0.46	0.43	0.42	0.65	0.63	0.74	0.65	0.55	0.55	0.45	0.65	0.65
Delay/Veh:	44.7	44.0	43.9	44.6	43.5	52.9	34.9	16.3	16.3	41.7	27.0	27.0
User DelAdj:	1.00	1.00	1.00	1.00	1.00	1.00	1.00	1.00	1.00	1.00	1.00	1.00
AdjDel/Veh:	44.7	44.0	43.9	44.6	43.5	52.9	34.9	16.3	16.3	41.7	27.0	27.0
LOS by Move:	D	D	D	D	D	D-	C-	B	B	D	C	C
HCM2kAvgQ:	3	3	3	5	5	6	10	11	11	4	12	12

Note: Queue reported is the number of cars per lane.

San Antonio Village Phase III MTA
SJ21-2068
Existing PM

Level Of Service Computation Report
2000 HCM Operations (Future Volume Alternative)
Existing PM

Intersection #5: El Camino Real and Ortega Avenue

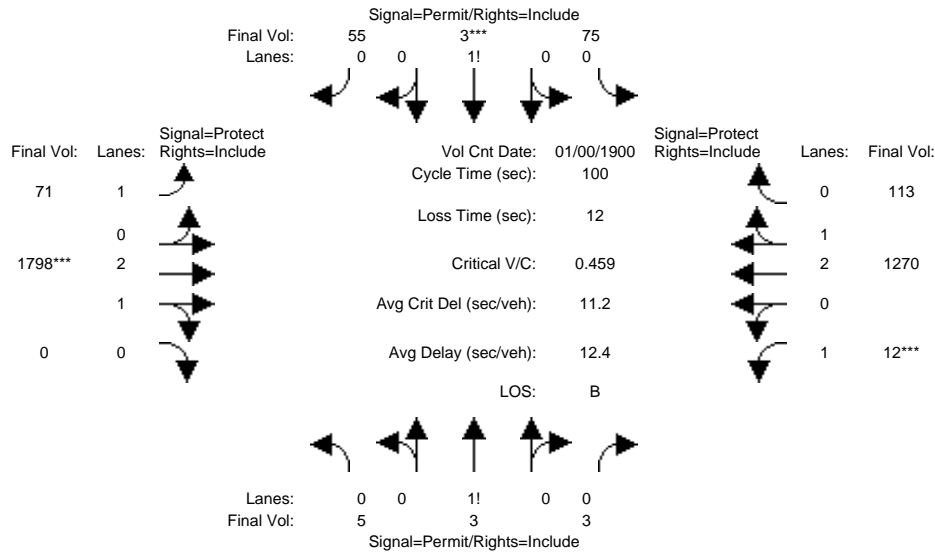

Approach:	North Bound			South Bound			East Bound			West Bound		
	L	T	R	L	T	R	L	T	R	L	T	R
Min. Green:	10	10	10	10	10	10	7	10	10	7	10	10
Y+R:	4.0	4.0	4.0	4.0	4.0	4.0	4.0	4.0	4.0	4.0	4.0	4.0

Volume Module:	>> Count Date: 0 Jan 1900 << 12:00:00 AM											
Base Vol:	5	3	3	75	3	55	71	1798	0	12	1270	113
Growth Adj:	1.00	1.00	1.00	1.00	1.00	1.00	1.00	1.00	1.00	1.00	1.00	1.00
Initial Bse:	5	3	3	75	3	55	71	1798	0	12	1270	113
Added Vol:	0	0	0	0	0	0	0	0	0	0	0	0
PasserByVol:	0	0	0	0	0	0	0	0	0	0	0	0
Initial Fut:	5	3	3	75	3	55	71	1798	0	12	1270	113
User Adj:	1.00	1.00	1.00	1.00	1.00	1.00	1.00	1.00	1.00	1.00	1.00	1.00
PHF Adj:	1.00	1.00	1.00	1.00	1.00	1.00	1.00	1.00	1.00	1.00	1.00	1.00
PHF Volume:	5	3	3	75	3	55	71	1798	0	12	1270	113
Reduct Vol:	0	0	0	0	0	0	0	0	0	0	0	0
Reduced Vol:	5	3	3	75	3	55	71	1798	0	12	1270	113
PCE Adj:	1.00	1.00	1.00	1.00	1.00	1.00	1.00	1.00	1.00	1.00	1.00	1.00
MLF Adj:	1.00	1.00	1.00	1.00	1.00	1.00	1.00	1.00	1.00	1.00	1.00	1.00
FinalVolume:	5	3	3	75	3	55	71	1798	0	12	1270	113

Saturation Flow Module:												
Sat/Lane:	1900	1900	1900	1900	1900	1900	1900	1900	1900	1900	1900	1900
Adjustment:	0.92	0.92	0.92	0.92	0.92	0.92	0.92	0.98	0.92	0.92	0.99	0.95
Lanes:	0.46	0.27	0.27	0.57	0.02	0.41	1.00	3.00	0.00	1.00	2.75	0.25
Final Sat.:	795	477	477	987	39	724	1750	5600	0	1750	5142	458

Capacity Analysis Module:												
Vol/Sat:	0.01	0.01	0.01	0.08	0.08	0.08	0.04	0.32	0.00	0.01	0.25	0.25
Crit Moves:					****			****			****	
Green Time:	15.5	15.5	15.5	15.5	15.5	15.5	16.0	65.5	0.0	7.0	56.5	56.5
Volume/Cap:	0.04	0.04	0.04	0.49	0.49	0.49	0.25	0.49	0.00	0.10	0.44	0.44
Uniform Del:	35.9	35.9	35.9	38.6	38.6	38.6	36.8	8.8	0.0	43.5	12.6	12.6
IncrcmntDel:	0.1	0.1	0.1	1.4	1.4	1.4	0.5	0.1	0.0	0.4	0.1	0.1
InitQueuDel:	0.0	0.0	0.0	0.0	0.0	0.0	0.0	0.0	0.0	0.0	0.0	0.0
Delay Adj:	1.00	1.00	1.00	1.00	1.00	1.00	1.00	1.00	0.00	1.00	1.00	1.00
Delay/Veh:	36.0	36.0	36.0	40.0	40.0	40.0	37.2	8.9	0.0	43.9	12.7	12.7
User DelAdj:	1.00	1.00	1.00	1.00	1.00	1.00	1.00	1.00	1.00	1.00	1.00	1.00
AdjDel/Veh:	36.0	36.0	36.0	40.0	40.0	40.0	37.2	8.9	0.0	43.9	12.7	12.7
LOS by Move:	D+	D+	D+	D	D	D	D+	A	A	D	B	B
HCM2kAvgQ:	0	0	0	5	5	5	2	10	0	0	8	8

Note: Queue reported is the number of cars per lane.

San Antonio Village Phase III MTA
 SJ21-2068
 Existing PM

Level Of Service Computation Report
 2000 HCM Operations (Future Volume Alternative)
 Existing PP PM

Intersection #5: El Camino Real and Ortega Avenue

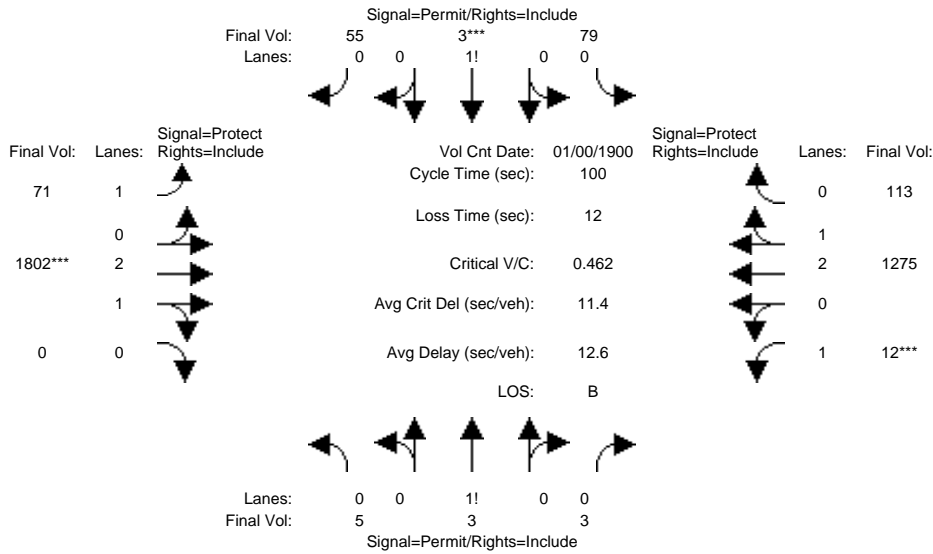

Approach:	North Bound			South Bound			East Bound			West Bound		
	L	T	R	L	T	R	L	T	R	L	T	R
Min. Green:	10	10	10	10	10	10	7	10	10	7	10	10
Y+R:	4.0	4.0	4.0	4.0	4.0	4.0	4.0	4.0	4.0	4.0	4.0	4.0
Volume Module: >> Count Date: 0 Jan 1900 << 12:00:00 AM												
Base Vol:	5	3	3	75	3	55	71	1798	0	12	1270	113
Growth Adj:	1.00	1.00	1.00	1.00	1.00	1.00	1.00	1.00	1.00	1.00	1.00	1.00
Initial Bse:	5	3	3	75	3	55	71	1798	0	12	1270	113
Added Vol:	0	0	0	4	0	0	0	4	0	0	5	0
PasserByVol:	0	0	0	0	0	0	0	0	0	0	0	0
Initial Fut:	5	3	3	79	3	55	71	1802	0	12	1275	113
User Adj:	1.00	1.00	1.00	1.00	1.00	1.00	1.00	1.00	1.00	1.00	1.00	1.00
PHF Adj:	1.00	1.00	1.00	1.00	1.00	1.00	1.00	1.00	1.00	1.00	1.00	1.00
PHF Volume:	5	3	3	79	3	55	71	1802	0	12	1275	113
Reduct Vol:	0	0	0	0	0	0	0	0	0	0	0	0
Reduced Vol:	5	3	3	79	3	55	71	1802	0	12	1275	113
PCE Adj:	1.00	1.00	1.00	1.00	1.00	1.00	1.00	1.00	1.00	1.00	1.00	1.00
MLF Adj:	1.00	1.00	1.00	1.00	1.00	1.00	1.00	1.00	1.00	1.00	1.00	1.00
FinalVolume:	5	3	3	79	3	55	71	1802	0	12	1275	113
Saturation Flow Module:												
Sat/Lane:	1900	1900	1900	1900	1900	1900	1900	1900	1900	1900	1900	1900
Adjustment:	0.92	0.92	0.92	0.92	0.92	0.92	0.92	0.98	0.92	0.92	0.99	0.95
Lanes:	0.46	0.27	0.27	0.58	0.02	0.40	1.00	3.00	0.00	1.00	2.75	0.25
Final Sat.:	795	477	477	1009	38	703	1750	5600	0	1750	5143	456
Capacity Analysis Module:												
Vol/Sat:	0.01	0.01	0.01	0.08	0.08	0.08	0.04	0.32	0.00	0.01	0.25	0.25
Crit Moves:				****			****			****		
Green Time:	15.9	15.9	15.9	15.9	15.9	15.9	15.9	65.1	0.0	7.0	56.3	56.3
Volume/Cap:	0.04	0.04	0.04	0.49	0.49	0.49	0.26	0.49	0.00	0.10	0.44	0.44
Delay/Veh:	35.7	35.7	35.7	39.8	39.8	39.8	37.4	9.1	0.0	43.9	12.8	12.8
User DelAdj:	1.00	1.00	1.00	1.00	1.00	1.00	1.00	1.00	1.00	1.00	1.00	1.00
AdjDel/Veh:	35.7	35.7	35.7	39.8	39.8	39.8	37.4	9.1	0.0	43.9	12.8	12.8
LOS by Move:	D+	D+	D+	D	D	D	D+	A	A	D	B	B
HCM2kAvgQ:	0	0	0	5	5	5	2	10	0	0	8	8

Note: Queue reported is the number of cars per lane.

San Antonio Village Phase III MTA
 SJ21-2068
 Existing PM

Level Of Service Computation Report
 2000 HCM Operations (Future Volume Alternative)
 Existing PM

Intersection #6: El Camino Real and Rengstorff Avenue

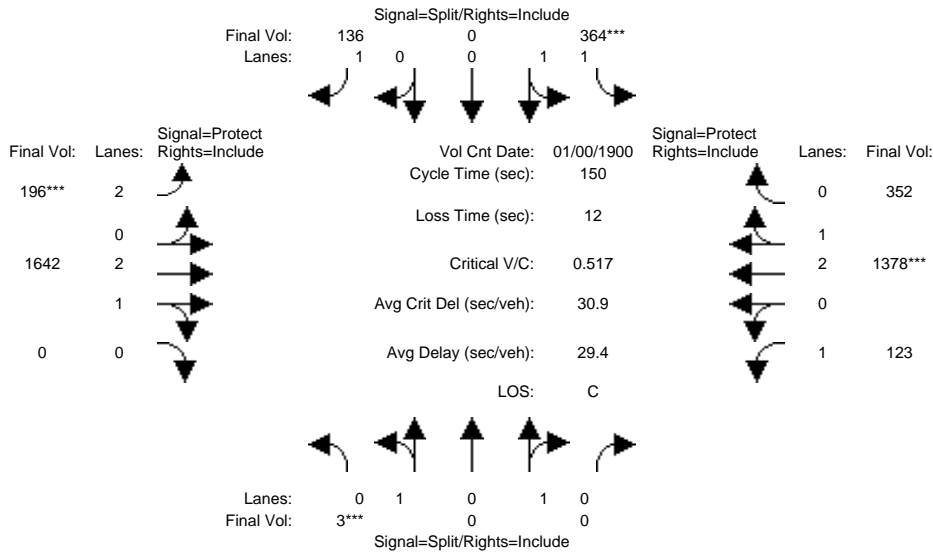

Approach:	North Bound			South Bound			East Bound			West Bound		
	L	T	R	L	T	R	L	T	R	L	T	R
Min. Green:	10	0	0	10	0	0	10	30	0	10	30	0
Y+R:	4.0	4.0	4.0	4.0	4.0	4.0	4.0	4.0	4.0	4.0	4.0	4.0
Volume Module: >> Count Date: 0 Jan 1900 << 12:00:00 AM												
Base Vol:	3	0	0	364	0	136	196	1642	0	123	1378	352
Growth Adj:	1.00	1.00	1.00	1.00	1.00	1.00	1.00	1.00	1.00	1.00	1.00	1.00
Initial Bse:	3	0	0	364	0	136	196	1642	0	123	1378	352
Added Vol:	0	0	0	0	0	0	0	0	0	0	0	0
PasserByVol:	0	0	0	0	0	0	0	0	0	0	0	0
Initial Fut:	3	0	0	364	0	136	196	1642	0	123	1378	352
User Adj:	1.00	1.00	1.00	1.00	1.00	1.00	1.00	1.00	1.00	1.00	1.00	1.00
PHF Adj:	1.00	1.00	1.00	1.00	1.00	1.00	1.00	1.00	1.00	1.00	1.00	1.00
PHF Volume:	3	0	0	364	0	136	196	1642	0	123	1378	352
Reduct Vol:	0	0	0	0	0	0	0	0	0	0	0	0
Reduced Vol:	3	0	0	364	0	136	196	1642	0	123	1378	352
PCE Adj:	1.00	1.00	1.00	1.00	1.00	1.00	1.00	1.00	1.00	1.00	1.00	1.00
MLF Adj:	1.00	1.00	1.00	1.00	1.00	1.00	1.00	1.00	1.00	1.00	1.00	1.00
FinalVolume:	3	0	0	364	0	136	196	1642	0	123	1378	352
Saturation Flow Module:												
Sat/Lane:	1900	1900	1900	1900	1900	1900	1900	1900	1900	1900	1900	1900
Adjustment:	0.95	1.00	0.92	0.93	1.00	0.92	0.83	0.98	0.92	0.92	0.99	0.95
Lanes:	1.00	0.00	1.00	2.00	0.00	1.00	2.00	3.00	0.00	1.00	2.37	0.63
Final Sat.:	1800	0	1750	3550	0	1750	3150	5600	0	1750	4459	1139
Capacity Analysis Module:												
Vol/Sat:	0.00	0.00	0.00	0.10	0.00	0.08	0.06	0.29	0.00	0.07	0.31	0.31
Crit Moves:	****			****			****			****		
Green Time:	10.0	0.0	0.0	27.7	0.0	27.7	16.8	80.9	0.0	19.4	83.5	83.5
Volume/Cap:	0.03	0.00	0.00	0.56	0.00	0.42	0.56	0.54	0.00	0.54	0.56	0.56
Uniform Del:	65.4	0.0	0.0	55.6	0.0	54.1	63.1	22.5	0.0	61.2	21.3	21.3
IncrcmntDel:	0.1	0.0	0.0	1.1	0.0	0.9	1.9	0.2	0.0	2.7	0.2	0.2
InitQueuDel:	0.0	0.0	0.0	0.0	0.0	0.0	0.0	0.0	0.0	0.0	0.0	0.0
Delay Adj:	1.00	0.00	0.00	1.00	0.00	1.00	1.00	1.00	0.00	1.00	1.00	1.00
Delay/Veh:	65.5	0.0	0.0	56.6	0.0	54.9	65.0	22.7	0.0	63.9	21.6	21.6
User DelAdj:	1.00	1.00	1.00	1.00	1.00	1.00	1.00	1.00	1.00	1.00	1.00	1.00
AdjDel/Veh:	65.5	0.0	0.0	56.6	0.0	54.9	65.0	22.7	0.0	63.9	21.6	21.6
LOS by Move:	E	A	A	E+	A	D-	E	C+	A	E	C+	C+
HCM2kAvgQ:	0	0	0	8	0	6	5	16	0	6	17	17

Note: Queue reported is the number of cars per lane.

San Antonio Village Phase III MTA
 SJ21-2068
 Existing PM

Level Of Service Computation Report
 2000 HCM Operations (Future Volume Alternative)
 Existing PP PM

Intersection #6: El Camino Real and Rengstorff Avenue

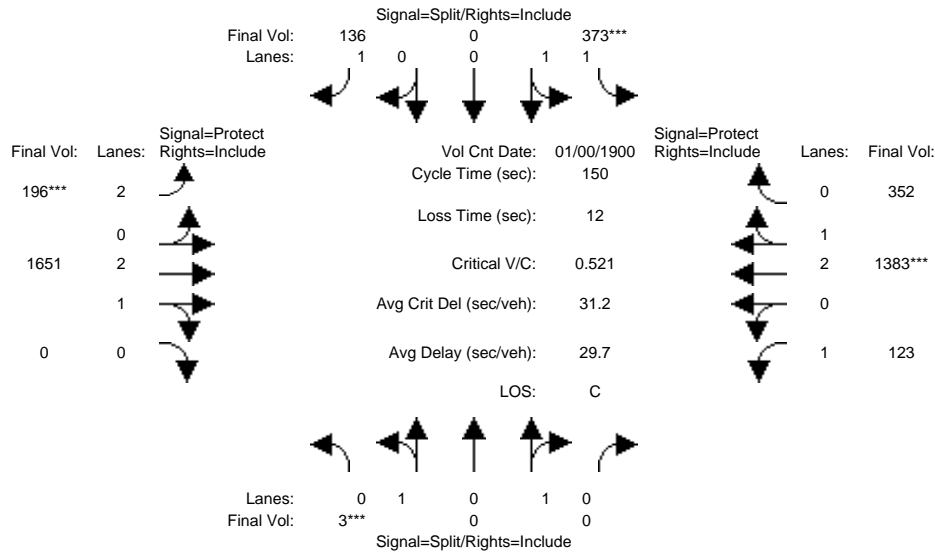

Approach:	North Bound			South Bound			East Bound			West Bound		
	L	T	R	L	T	R	L	T	R	L	T	R
Min. Green:	10	0	0	10	0	0	10	30	0	10	30	0
Y+R:	4.0	4.0	4.0	4.0	4.0	4.0	4.0	4.0	4.0	4.0	4.0	4.0
Volume Module: >> Count Date: 0 Jan 1900 << 12:00:00 AM												
Base Vol:	3	0	0	364	0	136	196	1642	0	123	1378	352
Growth Adj:	1.00	1.00	1.00	1.00	1.00	1.00	1.00	1.00	1.00	1.00	1.00	1.00
Initial Bse:	3	0	0	364	0	136	196	1642	0	123	1378	352
Added Vol:	0	0	0	9	0	0	0	9	0	0	5	0
PasserByVol:	0	0	0	0	0	0	0	0	0	0	0	0
Initial Fut:	3	0	0	373	0	136	196	1651	0	123	1383	352
User Adj:	1.00	1.00	1.00	1.00	1.00	1.00	1.00	1.00	1.00	1.00	1.00	1.00
PHF Adj:	1.00	1.00	1.00	1.00	1.00	1.00	1.00	1.00	1.00	1.00	1.00	1.00
PHF Volume:	3	0	0	373	0	136	196	1651	0	123	1383	352
Reduct Vol:	0	0	0	0	0	0	0	0	0	0	0	0
Reduced Vol:	3	0	0	373	0	136	196	1651	0	123	1383	352
PCE Adj:	1.00	1.00	1.00	1.00	1.00	1.00	1.00	1.00	1.00	1.00	1.00	1.00
MLF Adj:	1.00	1.00	1.00	1.00	1.00	1.00	1.00	1.00	1.00	1.00	1.00	1.00
FinalVolume:	3	0	0	373	0	136	196	1651	0	123	1383	352
Saturation Flow Module:												
Sat/Lane:	1900	1900	1900	1900	1900	1900	1900	1900	1900	1900	1900	1900
Adjustment:	0.95	1.00	0.92	0.93	1.00	0.92	0.83	0.98	0.92	0.92	0.99	0.95
Lanes:	1.00	0.00	1.00	2.00	0.00	1.00	2.00	3.00	0.00	1.00	2.37	0.63
Final Sat.:	1800	0	1750	3550	0	1750	3150	5600	0	1750	4462	1136
Capacity Analysis Module:												
Vol/Sat:	0.00	0.00	0.00	0.11	0.00	0.08	0.06	0.29	0.00	0.07	0.31	0.31
Crit Moves:	****			****			****			****		
Green Time:	10.0	0.0	0.0	28.2	0.0	28.2	16.7	80.6	0.0	19.2	83.1	83.1
Volume/Cap:	0.03	0.00	0.00	0.56	0.00	0.41	0.56	0.55	0.00	0.55	0.56	0.56
Delay/Veh:	65.5	0.0	0.0	56.3	0.0	54.5	65.2	23.0	0.0	64.2	21.8	21.8
User DelAdj:	1.00	1.00	1.00	1.00	1.00	1.00	1.00	1.00	1.00	1.00	1.00	1.00
AdjDel/Veh:	65.5	0.0	0.0	56.3	0.0	54.5	65.2	23.0	0.0	64.2	21.8	21.8
LOS by Move:	E	A	A	E+	A	D-	E	C+	A	E	C+	C+
HCM2kAvgQ:	0	0	0	8	0	6	5	16	0	6	17	17

Note: Queue reported is the number of cars per lane.

San Antonio Village Phase III MTA
 SJ21-2068
 Existing PM

Level Of Service Computation Report
 2000 HCM Operations (Future Volume Alternative)
 Existing PM

Intersection #7: Fayette Drive and San Antonio Road

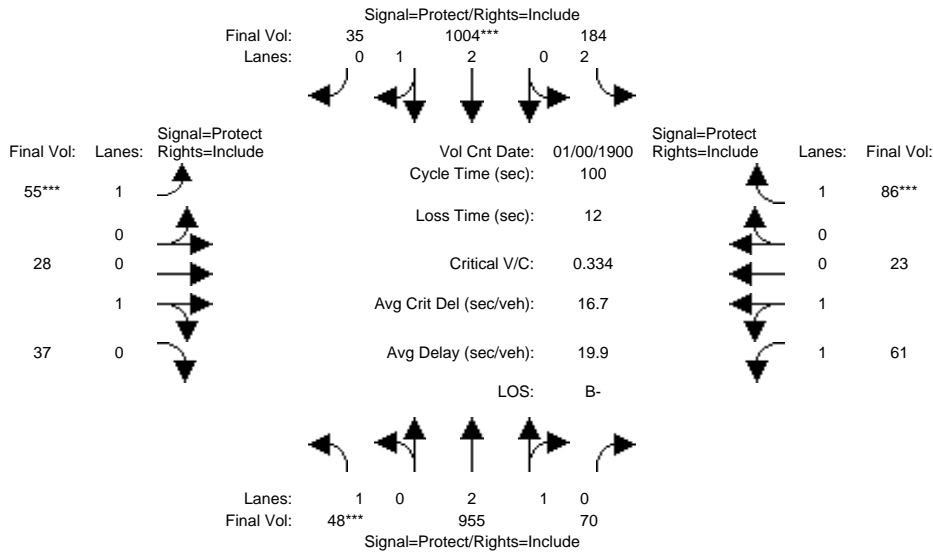

Approach:	North Bound			South Bound			East Bound			West Bound		
	L	T	R	L	T	R	L	T	R	L	T	R
Min. Green:	7	10	10	7	10	10	7	10	10	7	10	10
Y+R:	4.0	4.0	4.0	4.0	4.0	4.0	4.0	4.0	4.0	4.0	4.0	4.0

Volume Module:	>> Count Date: 0 Jan 1900 << 12:00:00 AM											
Base Vol:	48	955	70	184	1004	35	55	28	37	61	23	86
Growth Adj:	1.00	1.00	1.00	1.00	1.00	1.00	1.00	1.00	1.00	1.00	1.00	1.00
Initial Bse:	48	955	70	184	1004	35	55	28	37	61	23	86
Added Vol:	0	0	0	0	0	0	0	0	0	0	0	0
PasserByVol:	0	0	0	0	0	0	0	0	0	0	0	0
Initial Fut:	48	955	70	184	1004	35	55	28	37	61	23	86
User Adj:	1.00	1.00	1.00	1.00	1.00	1.00	1.00	1.00	1.00	1.00	1.00	1.00
PHF Adj:	1.00	1.00	1.00	1.00	1.00	1.00	1.00	1.00	1.00	1.00	1.00	1.00
PHF Volume:	48	955	70	184	1004	35	55	28	37	61	23	86
Reduct Vol:	0	0	0	0	0	0	0	0	0	0	0	0
Reduced Vol:	48	955	70	184	1004	35	55	28	37	61	23	86
PCE Adj:	1.00	1.00	1.00	1.00	1.00	1.00	1.00	1.00	1.00	1.00	1.00	1.00
MLF Adj:	1.00	1.00	1.00	1.00	1.00	1.00	1.00	1.00	1.00	1.00	1.00	1.00
FinalVolume:	48	955	70	184	1004	35	55	28	37	61	23	86

Saturation Flow Module:												
Sat/Lane:	1900	1900	1900	1900	1900	1900	1900	1900	1900	1900	1900	1900
Adjustment:	0.92	0.99	0.95	0.83	0.98	0.95	0.92	0.95	0.95	0.93	0.95	0.92
Lanes:	1.00	2.79	0.21	2.00	2.90	0.10	1.00	0.43	0.57	1.46	0.54	1.00
Final Sat.:	1750	5217	382	3150	5411	189	1750	775	1025	2578	972	1750

Capacity Analysis Module:												
Vol/Sat:	0.03	0.18	0.18	0.06	0.19	0.19	0.03	0.04	0.04	0.02	0.02	0.05
Crit Moves:	****			****			****					****
Green Time:	8.2	46.2	46.2	17.7	55.6	55.6	9.4	14.2	14.2	9.9	14.7	14.7
Volume/Cap:	0.33	0.40	0.40	0.33	0.33	0.33	0.33	0.25	0.25	0.24	0.16	0.33
Uniform Del:	43.3	17.7	17.7	36.0	12.1	12.1	42.4	38.2	38.2	41.5	37.2	38.2
IncrcmntDel:	1.4	0.1	0.1	0.4	0.1	0.1	1.2	0.5	0.5	0.3	0.1	0.8
InitQueuDel:	0.0	0.0	0.0	0.0	0.0	0.0	0.0	0.0	0.0	0.0	0.0	0.0
Delay Adj:	1.00	1.00	1.00	1.00	1.00	1.00	1.00	1.00	1.00	1.00	1.00	1.00
Delay/Veh:	44.7	17.8	17.8	36.4	12.2	12.2	43.6	38.7	38.7	41.9	37.4	39.0
User DelAdj:	1.00	1.00	1.00	1.00	1.00	1.00	1.00	1.00	1.00	1.00	1.00	1.00
AdjDel/Veh:	44.7	17.8	17.8	36.4	12.2	12.2	43.6	38.7	38.7	41.9	37.4	39.0
LOS by Move:	D	B	B	D+	B	B	D	D+	D+	D	D+	D+
HCM2kAvgQ:	1	7	7	3	5	5	2	2	2	1	1	3

Note: Queue reported is the number of cars per lane.

San Antonio Village Phase III MTA
 SJ21-2068
 Existing PM

Level Of Service Computation Report
 2000 HCM Operations (Future Volume Alternative)
 Existing PP PM

Intersection #7: Fayette Drive and San Antonio Road

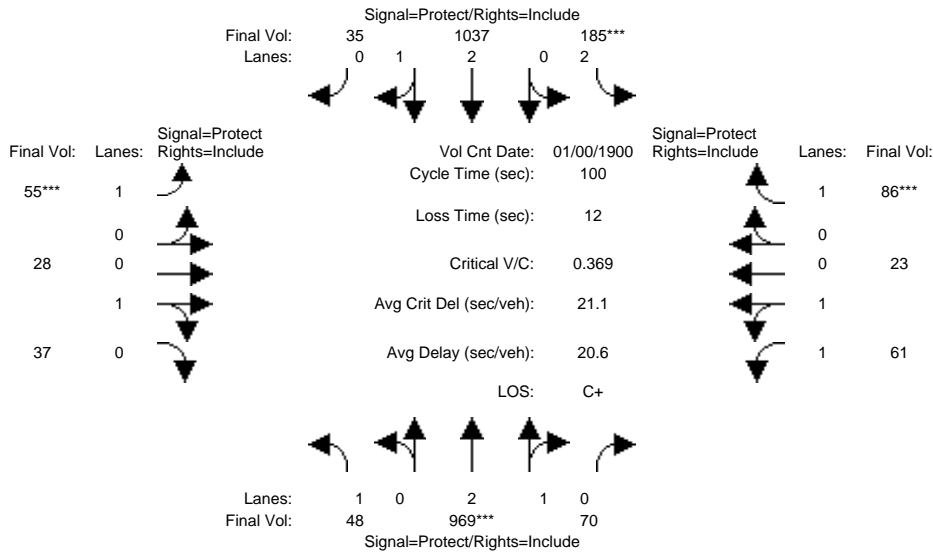

Approach:	North Bound			South Bound			East Bound			West Bound		
	L	T	R	L	T	R	L	T	R	L	T	R
Min. Green:	7	10	10	7	10	10	7	10	10	7	10	10
Y+R:	4.0	4.0	4.0	4.0	4.0	4.0	4.0	4.0	4.0	4.0	4.0	4.0
Volume Module: >> Count Date: 0 Jan 1900 << 12:00:00 AM												
Base Vol:	48	955	70	184	1004	35	55	28	37	61	23	86
Growth Adj:	1.00	1.00	1.00	1.00	1.00	1.00	1.00	1.00	1.00	1.00	1.00	1.00
Initial Bse:	48	955	70	184	1004	35	55	28	37	61	23	86
Added Vol:	0	14	0	1	33	0	0	0	0	0	0	0
PasserByVol:	0	0	0	0	0	0	0	0	0	0	0	0
Initial Fut:	48	969	70	185	1037	35	55	28	37	61	23	86
User Adj:	1.00	1.00	1.00	1.00	1.00	1.00	1.00	1.00	1.00	1.00	1.00	1.00
PHF Adj:	1.00	1.00	1.00	1.00	1.00	1.00	1.00	1.00	1.00	1.00	1.00	1.00
PHF Volume:	48	969	70	185	1037	35	55	28	37	61	23	86
Reduct Vol:	0	0	0	0	0	0	0	0	0	0	0	0
Reduced Vol:	48	969	70	185	1037	35	55	28	37	61	23	86
PCE Adj:	1.00	1.00	1.00	1.00	1.00	1.00	1.00	1.00	1.00	1.00	1.00	1.00
MLF Adj:	1.00	1.00	1.00	1.00	1.00	1.00	1.00	1.00	1.00	1.00	1.00	1.00
Final Volume:	48	969	70	185	1037	35	55	28	37	61	23	86
Saturation Flow Module:												
Sat/Lane:	1900	1900	1900	1900	1900	1900	1900	1900	1900	1900	1900	1900
Adjustment:	0.92	0.98	0.95	0.83	0.98	0.95	0.92	0.95	0.95	0.93	0.95	0.92
Lanes:	1.00	2.79	0.21	2.00	2.90	0.10	1.00	0.43	0.57	1.46	0.54	1.00
Final Sat.:	1750	5222	377	3150	5417	183	1750	775	1025	2578	972	1750
Capacity Analysis Module:												
Vol/Sat:	0.03	0.19	0.19	0.06	0.19	0.19	0.03	0.04	0.04	0.02	0.02	0.05
Crit Moves:	****			****			****			****		
Green Time:	17.7	50.3	50.3	15.9	48.5	48.5	8.5	12.8	12.8	9.0	13.3	13.3
Volume/Cap:	0.15	0.37	0.37	0.37	0.40	0.40	0.37	0.28	0.28	0.26	0.18	0.37
Delay/Veh:	35.0	15.3	15.3	38.0	16.5	16.5	44.8	40.1	40.1	42.9	38.7	40.5
User DelAdj:	1.00	1.00	1.00	1.00	1.00	1.00	1.00	1.00	1.00	1.00	1.00	1.00
AdjDel/Veh:	35.0	15.3	15.3	38.0	16.5	16.5	44.8	40.1	40.1	42.9	38.7	40.5
LOS by Move:	D+	B	B	D+	B	B	D	D	D	D	D+	D
HCM2kAvgQ:	1	6	6	3	7	7	2	2	2	2	1	3

Note: Queue reported is the number of cars per lane.

San Antonio Village Phase III MTA
SJ21-2068
Existing PM

Level Of Service Computation Report
2000 HCM Unsignalized (Future Volume Alternative)
Existing PM

Intersection #8: Miller Avenue and San Antonio Road

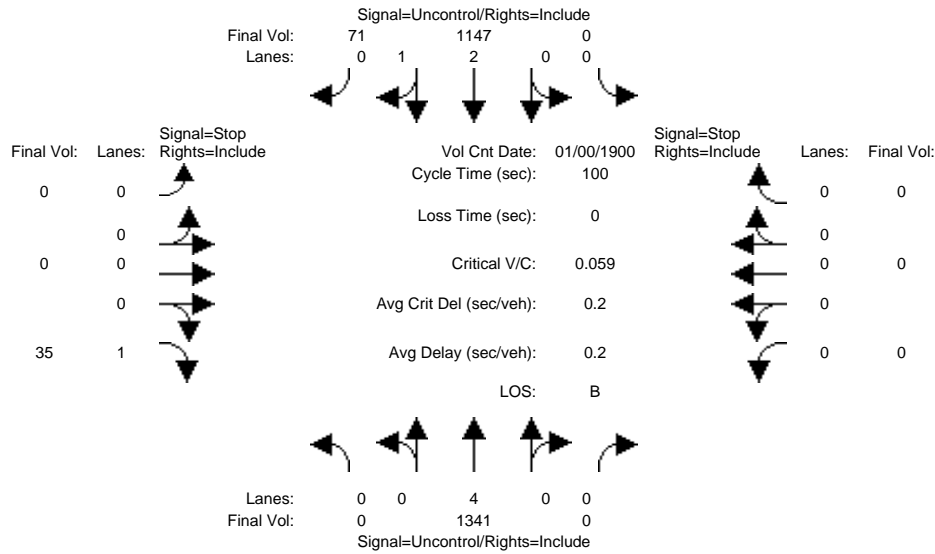

Approach:	North Bound			South Bound			East Bound			West Bound		
	L	T	R	L	T	R	L	T	R	L	T	R
Volume Module: >> Count Date: 0 Jan 1900 << 12:00:00 AM	0	1341	0	0	1147	71	0	0	35	0	0	0
Base Vol:	0	1341	0	0	1147	71	0	0	35	0	0	0
Growth Adj:	1.00	1.00	1.00	1.00	1.00	1.00	1.00	1.00	1.00	1.00	1.00	1.00
Initial Bse:	0	1341	0	0	1147	71	0	0	35	0	0	0
Added Vol:	0	0	0	0	0	0	0	0	0	0	0	0
PasserByVol:	0	0	0	0	0	0	0	0	0	0	0	0
Initial Fut:	0	1341	0	0	1147	71	0	0	35	0	0	0
User Adj:	1.00	1.00	1.00	1.00	1.00	1.00	1.00	1.00	1.00	1.00	1.00	1.00
PHF Adj:	1.00	1.00	1.00	1.00	1.00	1.00	1.00	1.00	1.00	1.00	1.00	1.00
PHF Volume:	0	1341	0	0	1147	71	0	0	35	0	0	0
Reduct Vol:	0	0	0	0	0	0	0	0	0	0	0	0
FinalVolume:	0	1341	0	0	1147	71	0	0	35	0	0	0
Critical Gap Module:	xxxxx	xxxx	xxxxx	xxxxx	xxxx	xxxxx	xxxxx	xxxx	6.9	xxxxx	xxxx	xxxxx
FollowUpTim:	xxxxx	xxxx	xxxxx	xxxxx	xxxx	xxxxx	xxxxx	xxxx	3.3	xxxxx	xxxx	xxxxx
Capacity Module:	xxxxx	xxxx	xxxxx	xxxxx	xxxx	xxxxx	xxxxx	xxxx	418	xxxxx	xxxx	xxxxx
Cnflct Vol:	xxxxx	xxxx	xxxxx	xxxxx	xxxx	xxxxx	xxxxx	xxxx	590	xxxxx	xxxx	xxxxx
Potent Cap.:	xxxxx	xxxx	xxxxx	xxxxx	xxxx	xxxxx	xxxxx	xxxx	590	xxxxx	xxxx	xxxxx
Move Cap.:	xxxxx	xxxx	xxxxx	xxxxx	xxxx	xxxxx	xxxxx	xxxx	590	xxxxx	xxxx	xxxxx
Volume/Cap:	xxxxx	xxxx	xxxxx	xxxxx	xxxx	xxxxx	xxxxx	xxxx	0.06	xxxxx	xxxx	xxxxx
Level Of Service Module:	xxxxx	xxxx	xxxxx	xxxxx	xxxx	xxxxx	xxxxx	xxxx	0.2	xxxxx	xxxx	xxxxx
2Way95thQ:	xxxxx	xxxx	xxxxx	xxxxx	xxxx	xxxxx	xxxxx	xxxx	11.5	xxxxx	xxxx	xxxxx
Control Del:	xxxxx	xxxx	xxxxx	xxxxx	xxxx	xxxxx	xxxxx	xxxx	B	xxxxx	xxxx	xxxxx
LOS by Move:	*	*	*	*	*	*	*	*	B	*	*	*
Movement:	LT - LTR - RT	LT - LTR - RT	LT - LTR - RT	LT - LTR - RT	LT - LTR - RT	LT - LTR - RT	LT - LTR - RT	LT - LTR - RT	LT - LTR - RT	LT - LTR - RT	LT - LTR - RT	LT - LTR - RT
Shared Cap.:	xxxxx	xxxx	xxxxx	xxxxx	xxxx	xxxxx	xxxxx	xxxx	xxxxx	xxxxx	xxxx	xxxxx
SharedQueue:	xxxxx	xxxx	xxxxx	xxxxx	xxxx	xxxxx	xxxxx	xxxx	xxxxx	xxxxx	xxxx	xxxxx
Shrd ConDel:	xxxxx	xxxx	xxxxx	xxxxx	xxxx	xxxxx	xxxxx	xxxx	xxxxx	xxxxx	xxxx	xxxxx
Shared LOS:	*	*	*	*	*	*	*	*	*	*	*	*
ApproachDel:	xxxxxxx		xxxxxxx			11.5		xxxxxxx				
ApproachLOS:	*		*			B		*				

Note: Queue reported is the number of cars per lane.

San Antonio Village Phase III MTA
SJ21-2068
Existing PM

Level Of Service Computation Report
2000 HCM Unsignalized (Future Volume Alternative)
Existing PP PM

Intersection #8: Miller Avenue and San Antonio Road

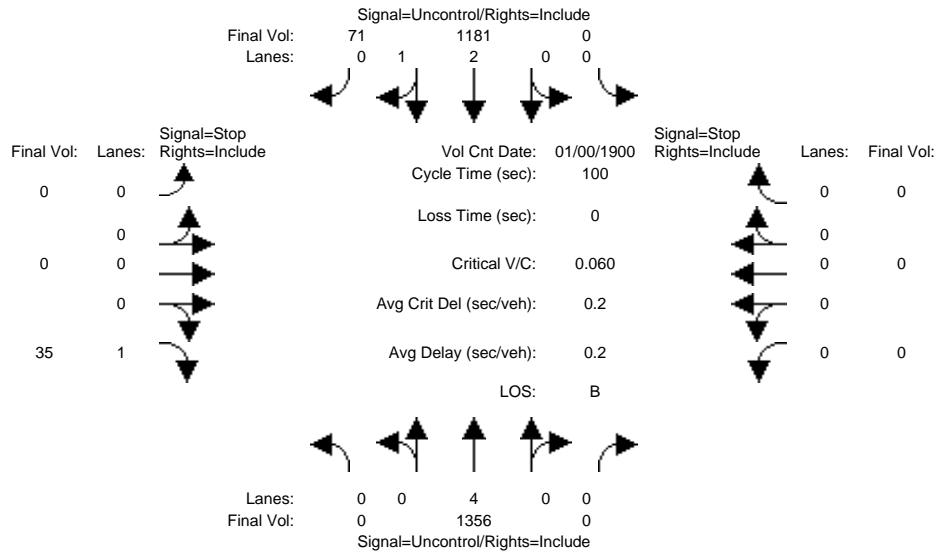

Approach:	North Bound			South Bound			East Bound			West Bound		
Movement:	L	T	R	L	T	R	L	T	R	L	T	R
Volume Module: >> Count Date: 0 Jan 1900 << 12:00:00 AM												
Base Vol:	0	1341	0	0	1147	71	0	0	35	0	0	0
Growth Adj:	1.00	1.00	1.00	1.00	1.00	1.00	1.00	1.00	1.00	1.00	1.00	1.00
Initial Bse:	0	1341	0	0	1147	71	0	0	35	0	0	0
Added Vol:	0	15	0	0	34	0	0	0	0	0	0	0
PasserByVol:	0	0	0	0	0	0	0	0	0	0	0	0
Initial Fut:	0	1356	0	0	1181	71	0	0	35	0	0	0
User Adj:	1.00	1.00	1.00	1.00	1.00	1.00	1.00	1.00	1.00	1.00	1.00	1.00
PHF Adj:	1.00	1.00	1.00	1.00	1.00	1.00	1.00	1.00	1.00	1.00	1.00	1.00
PHF Volume:	0	1356	0	0	1181	71	0	0	35	0	0	0
Reduct Vol:	0	0	0	0	0	0	0	0	0	0	0	0
FinalVolume:	0	1356	0	0	1181	71	0	0	35	0	0	0
Critical Gap Module:												
Critical Gp:	xxxxx	xxxx	xxxxx	xxxxx	xxxx	xxxxx	xxxxx	xxxx	6.9	xxxxx	xxxx	xxxxx
FollowUpTim:	xxxxx	xxxx	xxxxx	xxxxx	xxxx	xxxxx	xxxxx	xxxx	3.3	xxxxx	xxxx	xxxxx
Capacity Module:												
Cnflct Vol:	xxxx	xxxx	xxxxx	xxxx	xxxx	xxxxx	xxxx	xxxx	429	xxxx	xxxx	xxxxx
Potent Cap.:	xxxx	xxxx	xxxxx	xxxx	xxxx	xxxxx	xxxx	xxxx	580	xxxx	xxxx	xxxxx
Move Cap.:	xxxx	xxxx	xxxxx	xxxx	xxxx	xxxxx	xxxx	xxxx	580	xxxx	xxxx	xxxxx
Volume/Cap:	xxxx	xxxx	xxxx	xxxx	xxxx	xxxx	xxxx	xxxx	0.06	xxxx	xxxx	xxxx
Level Of Service Module:												
2Way95thQ:	xxxx	xxxx	xxxxx	xxxx	xxxx	xxxxx	xxxx	xxxx	0.2	xxxx	xxxx	xxxxx
Control Del:	xxxxx	xxxx	xxxxx	xxxxx	xxxx	xxxxx	xxxxx	xxxx	11.6	xxxxx	xxxx	xxxxx
LOS by Move:	*	*	*	*	*	*	*	*	B	*	*	*
Movement:	LT	LTR	RT	LT	LTR	RT	LT	LTR	RT	LT	LTR	RT
Shared Cap.:	xxxx	xxxx	xxxxx	xxxx	xxxx	xxxxx	xxxx	xxxx	xxxxx	xxxx	xxxx	xxxxx
SharedQueue:	xxxxx	xxxx	xxxxx	xxxxx	xxxx	xxxxx	xxxxx	xxxx	xxxxx	xxxxx	xxxx	xxxxx
Shrd ConDel:	xxxxx	xxxx	xxxxx	xxxxx	xxxx	xxxxx	xxxxx	xxxx	xxxxx	xxxxx	xxxx	xxxxx
Shared LOS:	*	*	*	*	*	*	*	*	*	*	*	*
ApproachDel:	xxxxxxx			xxxxxxx					11.6	xxxxxxx		
ApproachLOS:	*			*					B	*		

Note: Queue reported is the number of cars per lane.

San Antonio Village Phase III MTA
 SJ21-2068
 Existing PM

Level Of Service Computation Report
 2000 HCM Operations (Future Volume Alternative)
 Existing PM

Intersection #9: Nita Avenue and San Antonio Road

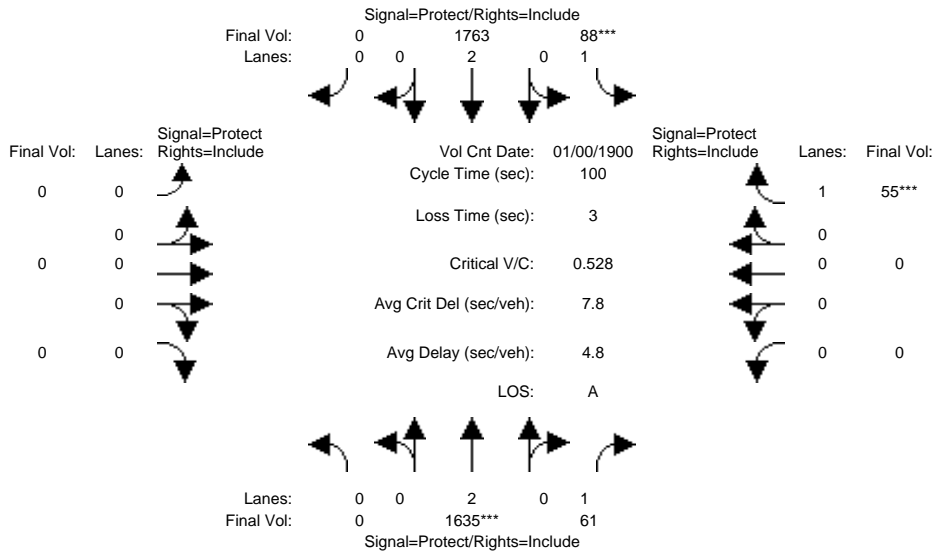

Approach:	North Bound			South Bound			East Bound			West Bound		
	L	T	R	L	T	R	L	T	R	L	T	R
Min. Green:	0	10	10	7	10	0	0	0	0	0	0	10
Y+R:	4.0	4.0	4.0	4.0	4.0	4.0	4.0	4.0	4.0	4.0	4.0	4.0
Volume Module: >> Count Date: 0 Jan 1900 << 12:00:00 AM												
Base Vol:	0	1635	61	88	1763	0	0	0	0	0	0	55
Growth Adj:	1.00	1.00	1.00	1.00	1.00	1.00	1.00	1.00	1.00	1.00	1.00	1.00
Initial Bse:	0	1635	61	88	1763	0	0	0	0	0	0	55
Added Vol:	0	0	0	0	0	0	0	0	0	0	0	0
PasserByVol:	0	0	0	0	0	0	0	0	0	0	0	0
Initial Fut:	0	1635	61	88	1763	0	0	0	0	0	0	55
User Adj:	1.00	1.00	1.00	1.00	1.00	1.00	1.00	1.00	1.00	1.00	1.00	1.00
PHF Adj:	1.00	1.00	1.00	1.00	1.00	1.00	1.00	1.00	1.00	1.00	1.00	1.00
PHF Volume:	0	1635	61	88	1763	0	0	0	0	0	0	55
Reduct Vol:	0	0	0	0	0	0	0	0	0	0	0	0
Reduced Vol:	0	1635	61	88	1763	0	0	0	0	0	0	55
PCE Adj:	1.00	1.00	1.00	1.00	1.00	1.00	1.00	1.00	1.00	1.00	1.00	1.00
MLF Adj:	1.00	1.00	1.00	1.00	1.00	1.00	1.00	1.00	1.00	1.00	1.00	1.00
FinalVolume:	0	1635	61	88	1763	0	0	0	0	0	0	55
Saturation Flow Module:												
Sat/Lane:	1900	1900	1900	1900	1900	1900	1900	1900	1900	1900	1900	1900
Adjustment:	0.92	1.00	0.92	0.92	1.00	0.92	0.92	1.00	0.92	0.92	1.00	0.92
Lanes:	0.00	2.00	1.00	1.00	2.00	0.00	0.00	0.00	0.00	0.00	0.00	1.00
Final Sat.:	0	3800	1750	1750	3800	0	0	0	0	0	0	1750
Capacity Analysis Module:												
Vol/Sat:	0.00	0.43	0.03	0.05	0.46	0.00	0.00	0.00	0.00	0.00	0.00	0.03
Crit Moves:	****		****									****
Green Time:	0.0	77.9	77.9	9.1	87.0	0.0	0.0	0.0	0.0	0.0	0.0	10.0
Volume/Cap:	0.00	0.55	0.04	0.55	0.53	0.00	0.00	0.00	0.00	0.00	0.00	0.31
Uniform Del:	0.0	4.3	2.5	43.5	1.6	0.0	0.0	0.0	0.0	0.0	0.0	41.8
IncrcmntDel:	0.0	0.2	0.0	4.1	0.2	0.0	0.0	0.0	0.0	0.0	0.0	1.0
InitQueuDel:	0.0	0.0	0.0	0.0	0.0	0.0	0.0	0.0	0.0	0.0	0.0	0.0
Delay Adj:	0.00	1.00	1.00	1.00	1.00	0.00	0.00	0.00	0.00	0.00	0.00	1.00
Delay/Veh:	0.0	4.5	2.5	47.6	1.7	0.0	0.0	0.0	0.0	0.0	0.0	42.8
User DelAdj:	1.00	1.00	1.00	1.00	1.00	1.00	1.00	1.00	1.00	1.00	1.00	1.00
AdjDel/Veh:	0.0	4.5	2.5	47.6	1.7	0.0	0.0	0.0	0.0	0.0	0.0	42.8
LOS by Move:	A	A	A	D	A	A	A	A	A	A	A	D
HCM2kAvgQ:	0	9	0	3	6	0	0	0	0	0	0	2

Note: Queue reported is the number of cars per lane.

San Antonio Village Phase III MTA
 SJ21-2068
 Existing PM

Level Of Service Computation Report
 2000 HCM Operations (Future Volume Alternative)
 Existing PP PM

Intersection #9: Nita Avenue and San Antonio Road

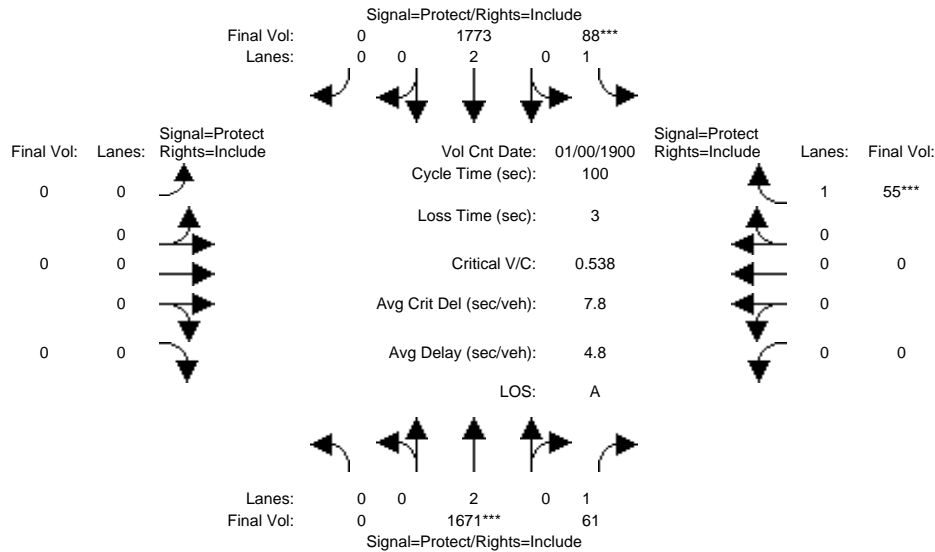

Approach:	North Bound			South Bound			East Bound			West Bound		
	L	T	R	L	T	R	L	T	R	L	T	R
Min. Green:	0	10	10	7	10	0	0	0	0	0	0	10
Y+R:	4.0	4.0	4.0	4.0	4.0	4.0	4.0	4.0	4.0	4.0	4.0	4.0
Volume Module: >> Count Date: 0 Jan 1900 << 12:00:00 AM												
Base Vol:	0	1635	61	88	1763	0	0	0	0	0	0	55
Growth Adj:	1.00	1.00	1.00	1.00	1.00	1.00	1.00	1.00	1.00	1.00	1.00	1.00
Initial Bse:	0	1635	61	88	1763	0	0	0	0	0	0	55
Added Vol:	0	36	0	0	10	0	0	0	0	0	0	0
PasserByVol:	0	0	0	0	0	0	0	0	0	0	0	0
Initial Fut:	0	1671	61	88	1773	0	0	0	0	0	0	55
User Adj:	1.00	1.00	1.00	1.00	1.00	1.00	1.00	1.00	1.00	1.00	1.00	1.00
PHF Adj:	1.00	1.00	1.00	1.00	1.00	1.00	1.00	1.00	1.00	1.00	1.00	1.00
PHF Volume:	0	1671	61	88	1773	0	0	0	0	0	0	55
Reduct Vol:	0	0	0	0	0	0	0	0	0	0	0	0
Reduced Vol:	0	1671	61	88	1773	0	0	0	0	0	0	55
PCE Adj:	1.00	1.00	1.00	1.00	1.00	1.00	1.00	1.00	1.00	1.00	1.00	1.00
MLF Adj:	1.00	1.00	1.00	1.00	1.00	1.00	1.00	1.00	1.00	1.00	1.00	1.00
FinalVolume:	0	1671	61	88	1773	0	0	0	0	0	0	55
Saturation Flow Module:												
Sat/Lane:	1900	1900	1900	1900	1900	1900	1900	1900	1900	1900	1900	1900
Adjustment:	0.92	1.00	0.92	0.92	1.00	0.92	0.92	1.00	0.92	0.92	1.00	0.92
Lanes:	0.00	2.00	1.00	1.00	2.00	0.00	0.00	0.00	0.00	0.00	0.00	1.00
Final Sat.:	0	3800	1750	1750	3800	0	0	0	0	0	0	1750
Capacity Analysis Module:												
Vol/Sat:	0.00	0.44	0.03	0.05	0.47	0.00	0.00	0.00	0.00	0.00	0.00	0.03
Crit Moves:	****			****						****		
Green Time:	0.0	78.1	78.1	8.9	87.0	0.0	0.0	0.0	0.0	0.0	0.0	10.0
Volume/Cap:	0.00	0.56	0.04	0.56	0.54	0.00	0.00	0.00	0.00	0.00	0.00	0.31
Delay/Veh:	0.0	4.5	2.5	48.3	1.8	0.0	0.0	0.0	0.0	0.0	0.0	42.8
User DelAdj:	1.00	1.00	1.00	1.00	1.00	1.00	1.00	1.00	1.00	1.00	1.00	1.00
AdjDel/Veh:	0.0	4.5	2.5	48.3	1.8	0.0	0.0	0.0	0.0	0.0	0.0	42.8
LOS by Move:	A	A	A	D	A	A	A	A	A	A	A	D
HCM2kAvgQ:	0	9	0	3	7	0	0	0	0	0	0	2

Note: Queue reported is the number of cars per lane.

San Antonio Village Phase III MTA
 SJ21-2068
 Existing PM

Level Of Service Computation Report
 2000 HCM Operations (Future Volume Alternative)
 Existing PM

Intersection #10: California Street and San Antonio Road

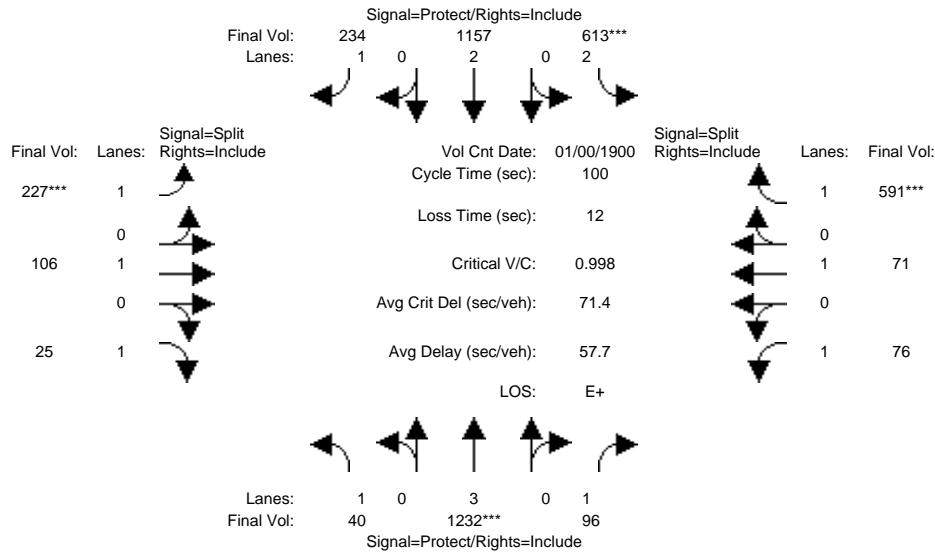

Approach:	North Bound			South Bound			East Bound			West Bound		
	L	T	R	L	T	R	L	T	R	L	T	R
Min. Green:	7	10	10	7	10	10	10	10	10	10	10	10
Y+R:	4.0	4.0	4.0	4.0	4.0	4.0	4.0	4.0	4.0	4.0	4.0	4.0

Volume Module:	>>	Count	Date:	0	Jan	1900	<<	12:	00:00	AM
Base Vol:	40	1232	96	613	1157	234	227	106	25	76 71 591
Growth Adj:	1.00	1.00	1.00	1.00	1.00	1.00	1.00	1.00	1.00	1.00 1.00 1.00
Initial Bse:	40	1232	96	613	1157	234	227	106	25	76 71 591
Added Vol:	0	0	0	0	0	0	0	0	0	0 0 0
PasserByVol:	0	0	0	0	0	0	0	0	0	0 0 0
Initial Fut:	40	1232	96	613	1157	234	227	106	25	76 71 591
User Adj:	1.00	1.00	1.00	1.00	1.00	1.00	1.00	1.00	1.00	1.00 1.00 1.00
PHF Adj:	1.00	1.00	1.00	1.00	1.00	1.00	1.00	1.00	1.00	1.00 1.00 1.00
PHF Volume:	40	1232	96	613	1157	234	227	106	25	76 71 591
Reduct Vol:	0	0	0	0	0	0	0	0	0	0 0 0
Reduced Vol:	40	1232	96	613	1157	234	227	106	25	76 71 591
PCE Adj:	1.00	1.00	1.00	1.00	1.00	1.00	1.00	1.00	1.00	1.00 1.00 1.00
MLF Adj:	1.00	1.00	1.00	1.00	1.00	1.00	1.00	1.00	1.00	1.00 1.00 1.00
FinalVolume:	40	1232	96	613	1157	234	227	106	25	76 71 591

Saturation Flow Module:	North Bound			South Bound			East Bound			West Bound		
Sat/Lane:	1900	1900	1900	1900	1900	1900	1900	1900	1900	1900	1900	1900
Adjustment:	0.92	1.00	0.92	0.83	1.00	0.92	0.92	1.00	0.92	0.92	1.00	0.92
Lanes:	1.00	3.00	1.00	2.00	2.00	1.00	1.00	1.00	1.00	1.00	1.00	1.00
Final Sat.:	1750	5700	1750	3150	3800	1750	1750	1900	1750	1750	1900	1750

Capacity Analysis Module:	North Bound			South Bound			East Bound			West Bound		
Vol/Sat:	0.02	0.22	0.05	0.19	0.30	0.13	0.13	0.06	0.01	0.04	0.04	0.34
Crit Moves:	****	****	****	****	****	****	****	****	****	****	****	****
Green Time:	7.7	21.7	21.7	19.5	33.5	33.5	13.0	13.0	13.0	33.8	33.8	33.8
Volume/Cap:	0.30	1.00	0.25	1.00	0.91	0.40	1.00	0.43	0.11	0.13	0.11	1.00
Uniform Del:	43.6	39.1	32.5	40.2	31.8	25.6	43.5	40.1	38.4	22.9	22.7	33.0
IncrcmntDel:	1.2	25.1	0.4	35.8	9.8	0.4	59.0	1.2	0.2	0.1	0.1	36.4
InitQueuDel:	0.0	0.0	0.0	0.0	0.0	0.0	0.0	0.0	0.0	0.0	0.0	0.0
Delay Adj:	1.00	1.00	1.00	1.00	1.00	1.00	1.00	1.00	1.00	1.00	1.00	1.00
Delay/Veh:	44.8	64.2	32.8	76.0	41.7	26.0	102.5	41.3	38.6	23.0	22.8	69.5
User DelAdj:	1.00	1.00	1.00	1.00	1.00	1.00	1.00	1.00	1.00	1.00	1.00	1.00
AdjDel/Veh:	44.8	64.2	32.8	76.0	41.7	26.0	102.5	41.3	38.6	23.0	22.8	69.5
LOS by Move:	D	E	C-	E-	D	C	F	D	D+	C+	C+	E
HCM2kAvgQ:	1	16	3	14	19	6	12	3	1	2	1	24

Note: Queue reported is the number of cars per lane.

San Antonio Village Phase III MTA
 SJ21-2068
 Existing PM

Level Of Service Computation Report
 2000 HCM Operations (Future Volume Alternative)
 Existing PP PM

Intersection #10: California Street and San Antonio Road

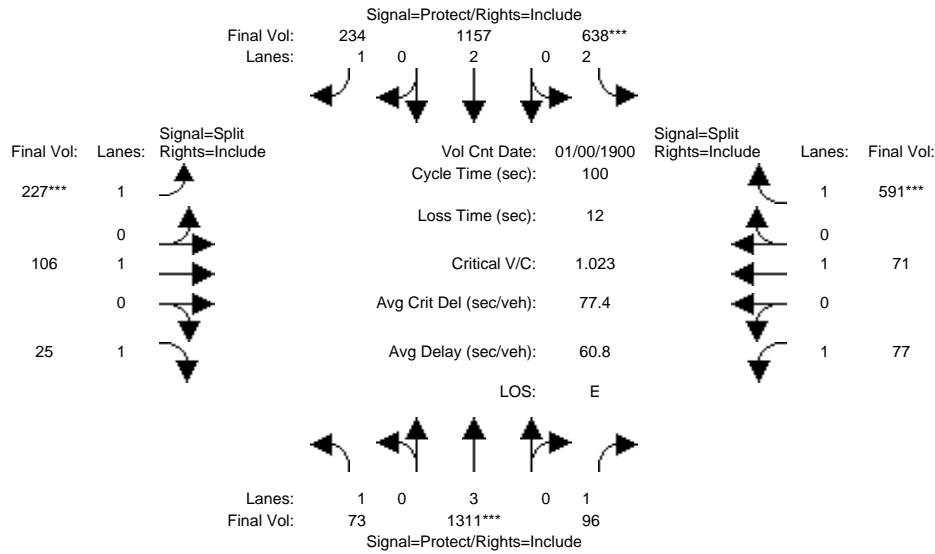

Approach:	North Bound			South Bound			East Bound			West Bound		
Movement:	L	T	R	L	T	R	L	T	R	L	T	R
Min. Green:	7	10	10	7	10	10	10	10	10	10	10	10
Y+R:	4.0	4.0	4.0	4.0	4.0	4.0	4.0	4.0	4.0	4.0	4.0	4.0
Volume Module: >> Count Date: 0 Jan 1900 << 12:00:00 AM												
Base Vol:	40	1232	96	613	1157	234	227	106	25	76	71	591
Growth Adj:	1.00	1.00	1.00	1.00	1.00	1.00	1.00	1.00	1.00	1.00	1.00	1.00
Initial Bse:	40	1232	96	613	1157	234	227	106	25	76	71	591
Added Vol:	33	79	0	25	0	0	0	0	0	1	0	0
PasserByVol:	0	0	0	0	0	0	0	0	0	0	0	0
Initial Fut:	73	1311	96	638	1157	234	227	106	25	77	71	591
User Adj:	1.00	1.00	1.00	1.00	1.00	1.00	1.00	1.00	1.00	1.00	1.00	1.00
PHF Adj:	1.00	1.00	1.00	1.00	1.00	1.00	1.00	1.00	1.00	1.00	1.00	1.00
PHF Volume:	73	1311	96	638	1157	234	227	106	25	77	71	591
Reduct Vol:	0	0	0	0	0	0	0	0	0	0	0	0
Reduced Vol:	73	1311	96	638	1157	234	227	106	25	77	71	591
PCE Adj:	1.00	1.00	1.00	1.00	1.00	1.00	1.00	1.00	1.00	1.00	1.00	1.00
MLF Adj:	1.00	1.00	1.00	1.00	1.00	1.00	1.00	1.00	1.00	1.00	1.00	1.00
FinalVolume:	73	1311	96	638	1157	234	227	106	25	77	71	591
Saturation Flow Module:												
Sat/Lane:	1900	1900	1900	1900	1900	1900	1900	1900	1900	1900	1900	1900
Adjustment:	0.92	1.00	0.92	0.83	1.00	0.92	0.92	1.00	0.92	0.92	1.00	0.92
Lanes:	1.00	3.00	1.00	2.00	2.00	1.00	1.00	1.00	1.00	1.00	1.00	1.00
Final Sat.:	1750	5700	1750	3150	3800	1750	1750	1900	1750	1750	1900	1750
Capacity Analysis Module:												
Vol/Sat:	0.04	0.23	0.05	0.20	0.30	0.13	0.13	0.06	0.01	0.04	0.04	0.34
Crit Moves:	****			****			****			****		
Green Time:	7.9	22.5	22.5	19.8	34.4	34.4	12.7	12.7	12.7	33.0	33.0	33.0
Volume/Cap:	0.53	1.02	0.24	1.02	0.89	0.39	1.02	0.44	0.11	0.13	0.11	1.02
Delay/Veh:	48.0	69.8	32.1	82.0	38.5	25.3	110.1	41.7	38.9	23.6	23.4	76.8
User DelAdj:	1.00	1.00	1.00	1.00	1.00	1.00	1.00	1.00	1.00	1.00	1.00	1.00
AdjDel/Veh:	48.0	69.8	32.1	82.0	38.5	25.3	110.1	41.7	38.9	23.6	23.4	76.8
LOS by Move:	D	E	C-	F	D+	C	F	D	D+	C	C	E-
HCM2kAvgQ:	2	18	3	15	18	6	13	3	1	2	1	25

Note: Queue reported is the number of cars per lane.

San Antonio Village Phase III MTA
 SJ21-2068
 Existing PM

Level Of Service Computation Report
 2000 HCM Operations (Future Volume Alternative)
 Existing PM

Intersection #11: California Street and Pacchetti Way

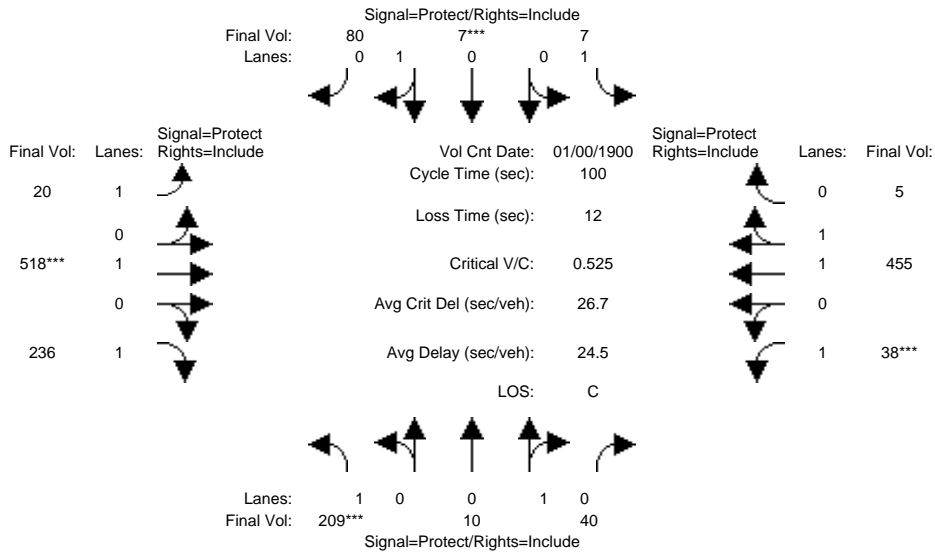

Approach:	North Bound			South Bound			East Bound			West Bound		
Movement:	L	T	R	L	T	R	L	T	R	L	T	R
Min. Green:	7	10	10	7	10	10	7	10	10	7	10	10
Y+R:	4.0	4.0	4.0	4.0	4.0	4.0	4.0	4.0	4.0	4.0	4.0	4.0
Volume Module: >> Count Date: 0 Jan 1900 << 12:00:00 AM												
Base Vol:	209	10	40	7	7	80	20	518	236	38	455	5
Growth Adj:	1.00	1.00	1.00	1.00	1.00	1.00	1.00	1.00	1.00	1.00	1.00	1.00
Initial Bse:	209	10	40	7	7	80	20	518	236	38	455	5
Added Vol:	0	0	0	0	0	0	0	0	0	0	0	0
PasserByVol:	0	0	0	0	0	0	0	0	0	0	0	0
Initial Fut:	209	10	40	7	7	80	20	518	236	38	455	5
User Adj:	1.00	1.00	1.00	1.00	1.00	1.00	1.00	1.00	1.00	1.00	1.00	1.00
PHF Adj:	1.00	1.00	1.00	1.00	1.00	1.00	1.00	1.00	1.00	1.00	1.00	1.00
PHF Volume:	209	10	40	7	7	80	20	518	236	38	455	5
Reduct Vol:	0	0	0	0	0	0	0	0	0	0	0	0
Reduced Vol:	209	10	40	7	7	80	20	518	236	38	455	5
PCE Adj:	1.00	1.00	1.00	1.00	1.00	1.00	1.00	1.00	1.00	1.00	1.00	1.00
MLF Adj:	1.00	1.00	1.00	1.00	1.00	1.00	1.00	1.00	1.00	1.00	1.00	1.00
FinalVolume:	209	10	40	7	7	80	20	518	236	38	455	5
Saturation Flow Module:												
Sat/Lane:	1900	1900	1900	1900	1900	1900	1900	1900	1900	1900	1900	1900
Adjustment:	0.92	0.95	0.95	0.92	0.95	0.95	0.92	1.00	0.92	0.92	0.97	0.95
Lanes:	1.00	0.20	0.80	1.00	0.08	0.92	1.00	1.00	1.00	1.00	1.98	0.02
Final Sat.:	1750	360	1440	1750	145	1655	1750	1900	1750	1750	3660	40
Capacity Analysis Module:												
Vol/Sat:	0.12	0.03	0.03	0.00	0.05	0.05	0.01	0.27	0.13	0.02	0.12	0.12
Crit Moves:	****				****			****		****		
Green Time:	21.6	18.6	18.6	13.0	10.0	10.0	20.3	49.4	49.4	7.0	36.1	36.1
Volume/Cap:	0.55	0.15	0.15	0.03	0.48	0.48	0.06	0.55	0.27	0.31	0.34	0.34
Uniform Del:	34.9	34.1	34.1	38.0	42.6	42.6	32.1	17.6	14.8	44.2	23.3	23.3
IncrementDel:	1.8	0.2	0.2	0.1	2.0	2.0	0.1	0.7	0.2	1.4	0.2	0.2
InitQueueDel:	0.0	0.0	0.0	0.0	0.0	0.0	0.0	0.0	0.0	0.0	0.0	0.0
Delay Adj:	1.00	1.00	1.00	1.00	1.00	1.00	1.00	1.00	1.00	1.00	1.00	1.00
Delay/Veh:	36.6	34.3	34.3	38.0	44.6	44.6	32.2	18.3	15.0	45.7	23.5	23.5
User DelAdj:	1.00	1.00	1.00	1.00	1.00	1.00	1.00	1.00	1.00	1.00	1.00	1.00
AdjDel/Veh:	36.6	34.3	34.3	38.0	44.6	44.6	32.2	18.3	15.0	45.7	23.5	23.5
LOS by Move:	D+	C-	C-	D+	D	D	C-	B-	B	D	C	C
HCM2kAvgQ:	7	1	1	0	3	3	1	11	4	1	5	5

Note: Queue reported is the number of cars per lane.

San Antonio Village Phase III MTA
 SJ21-2068
 Existing PM

Level Of Service Computation Report
 2000 HCM Operations (Future Volume Alternative)
 Existing PP PM

Intersection #11: California Street and Pacchetti Way

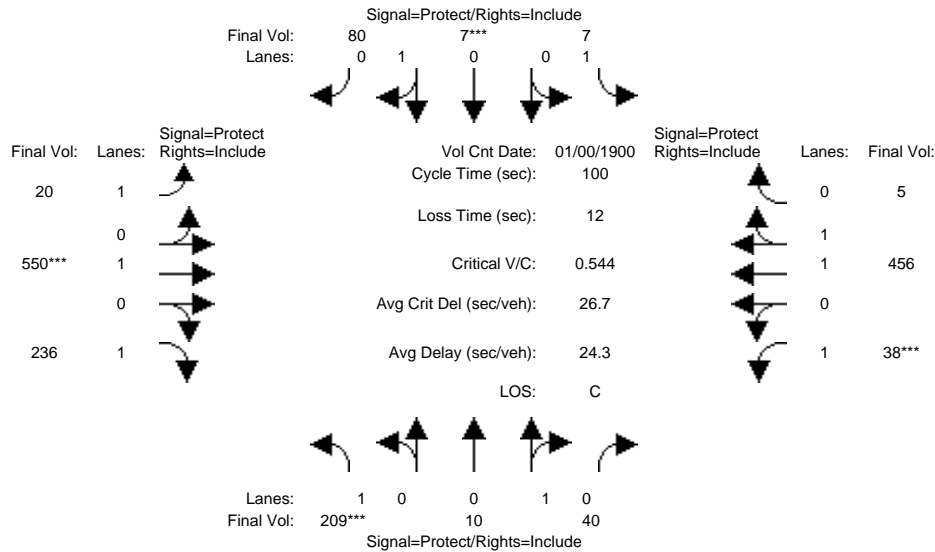

Approach:	North Bound			South Bound			East Bound			West Bound		
Movement:	L	T	R	L	T	R	L	T	R	L	T	R
Min. Green:	7	10	10	7	10	10	7	10	10	7	10	10
Y+R:	4.0	4.0	4.0	4.0	4.0	4.0	4.0	4.0	4.0	4.0	4.0	4.0
Volume Module: >> Count Date: 0 Jan 1900 << 12:00:00 AM												
Base Vol:	209	10	40	7	7	80	20	518	236	38	455	5
Growth Adj:	1.00	1.00	1.00	1.00	1.00	1.00	1.00	1.00	1.00	1.00	1.00	1.00
Initial Bse:	209	10	40	7	7	80	20	518	236	38	455	5
Added Vol:	0	0	0	0	0	0	0	32	0	0	1	0
PasserByVol:	0	0	0	0	0	0	0	0	0	0	0	0
Initial Fut:	209	10	40	7	7	80	20	550	236	38	456	5
User Adj:	1.00	1.00	1.00	1.00	1.00	1.00	1.00	1.00	1.00	1.00	1.00	1.00
PHF Adj:	1.00	1.00	1.00	1.00	1.00	1.00	1.00	1.00	1.00	1.00	1.00	1.00
PHF Volume:	209	10	40	7	7	80	20	550	236	38	456	5
Reduct Vol:	0	0	0	0	0	0	0	0	0	0	0	0
Reduced Vol:	209	10	40	7	7	80	20	550	236	38	456	5
PCE Adj:	1.00	1.00	1.00	1.00	1.00	1.00	1.00	1.00	1.00	1.00	1.00	1.00
MLF Adj:	1.00	1.00	1.00	1.00	1.00	1.00	1.00	1.00	1.00	1.00	1.00	1.00
FinalVolume:	209	10	40	7	7	80	20	550	236	38	456	5
Saturation Flow Module:												
Sat/Lane:	1900	1900	1900	1900	1900	1900	1900	1900	1900	1900	1900	1900
Adjustment:	0.92	0.95	0.95	0.92	0.95	0.95	0.92	1.00	0.92	0.92	0.97	0.95
Lanes:	1.00	0.20	0.80	1.00	0.08	0.92	1.00	1.00	1.00	1.00	1.98	0.02
Final Sat.:	1750	360	1440	1750	145	1655	1750	1900	1750	1750	3660	40
Capacity Analysis Module:												
Vol/Sat:	0.12	0.03	0.03	0.00	0.05	0.05	0.01	0.29	0.13	0.02	0.12	0.12
Crit Moves:	****			****			****			****		
Green Time:	20.7	18.1	18.1	12.7	10.0	10.0	20.6	50.3	50.3	7.0	36.7	36.7
Volume/Cap:	0.58	0.15	0.15	0.03	0.48	0.48	0.06	0.58	0.27	0.31	0.34	0.34
Delay/Veh:	37.9	34.7	34.7	38.4	44.6	44.6	32.0	18.3	14.5	45.7	23.1	23.1
User DelAdj:	1.00	1.00	1.00	1.00	1.00	1.00	1.00	1.00	1.00	1.00	1.00	1.00
AdjDel/Veh:	37.9	34.7	34.7	38.4	44.6	44.6	32.0	18.3	14.5	45.7	23.1	23.1
LOS by Move:	D+	C-	C-	D+	D	D	C	B-	B	D	C	C
HCM2kAvgQ:	7	1	1	0	3	3	1	12	4	1	5	5

Note: Queue reported is the number of cars per lane.

San Antonio Village Phase III MTA
 SJ21-2068
 Existing PM

Level Of Service Computation Report
 2000 HCM Operations (Future Volume Alternative)
 Existing PM

Intersection #12: California Street and Showers Drive

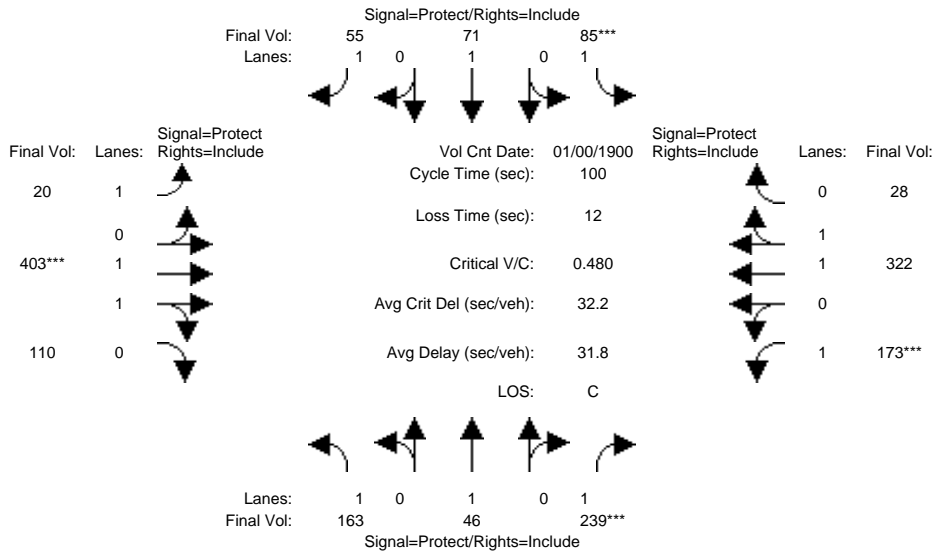

Approach:	North Bound			South Bound			East Bound			West Bound		
Movement:	L	T	R	L	T	R	L	T	R	L	T	R
Min. Green:	7	10	10	7	10	10	7	10	10	7	10	10
Y+R:	4.0	4.0	4.0	4.0	4.0	4.0	4.0	4.0	4.0	4.0	4.0	4.0
Volume Module: >> Count Date: 0 Jan 1900 << 12:00:00 AM												
Base Vol:	163	46	239	85	71	55	20	403	110	173	322	28
Growth Adj:	1.00	1.00	1.00	1.00	1.00	1.00	1.00	1.00	1.00	1.00	1.00	1.00
Initial Bse:	163	46	239	85	71	55	20	403	110	173	322	28
Added Vol:	0	0	0	0	0	0	0	0	0	0	0	0
PasserByVol:	0	0	0	0	0	0	0	0	0	0	0	0
Initial Fut:	163	46	239	85	71	55	20	403	110	173	322	28
User Adj:	1.00	1.00	1.00	1.00	1.00	1.00	1.00	1.00	1.00	1.00	1.00	1.00
PHF Adj:	1.00	1.00	1.00	1.00	1.00	1.00	1.00	1.00	1.00	1.00	1.00	1.00
PHF Volume:	163	46	239	85	71	55	20	403	110	173	322	28
Reduct Vol:	0	0	0	0	0	0	0	0	0	0	0	0
Reduced Vol:	163	46	239	85	71	55	20	403	110	173	322	28
PCE Adj:	1.00	1.00	1.00	1.00	1.00	1.00	1.00	1.00	1.00	1.00	1.00	1.00
MLF Adj:	1.00	1.00	1.00	1.00	1.00	1.00	1.00	1.00	1.00	1.00	1.00	1.00
FinalVolume:	163	46	239	85	71	55	20	403	110	173	322	28
Saturation Flow Module:												
Sat/Lane:	1900	1900	1900	1900	1900	1900	1900	1900	1900	1900	1900	1900
Adjustment:	0.92	1.00	0.92	0.92	1.00	0.92	0.92	0.98	0.95	0.92	0.98	0.95
Lanes:	1.00	1.00	1.00	1.00	1.00	1.00	1.00	1.56	0.44	1.00	1.84	0.16
Final Sat.:	1750	1900	1750	1750	1900	1750	1750	2906	793	1750	3404	296
Capacity Analysis Module:												
Vol/Sat:	0.09	0.02	0.14	0.05	0.04	0.03	0.01	0.14	0.14	0.10	0.09	0.09
Crit Moves:			****	****				****		****		
Green Time:	18.6	28.4	28.4	10.1	20.0	20.0	20.4	28.9	28.9	20.6	29.1	29.1
Volume/Cap:	0.50	0.09	0.48	0.48	0.19	0.16	0.06	0.48	0.48	0.48	0.33	0.33
Uniform Del:	36.5	26.2	29.7	42.5	33.3	33.1	32.1	29.4	29.4	35.0	27.8	27.8
IncrementDel:	1.2	0.1	0.7	2.1	0.2	0.2	0.1	0.3	0.3	1.0	0.2	0.2
InitQueueDel:	0.0	0.0	0.0	0.0	0.0	0.0	0.0	0.0	0.0	0.0	0.0	0.0
Delay Adj:	1.00	1.00	1.00	1.00	1.00	1.00	1.00	1.00	1.00	1.00	1.00	1.00
Delay/Veh:	37.8	26.3	30.4	44.5	33.5	33.3	32.1	29.7	29.7	36.0	27.9	27.9
User DelAdj:	1.00	1.00	1.00	1.00	1.00	1.00	1.00	1.00	1.00	1.00	1.00	1.00
AdjDel/Veh:	37.8	26.3	30.4	44.5	33.5	33.3	32.1	29.7	29.7	36.0	27.9	27.9
LOS by Move:	D+	C	C	D	C-	C-	C-	C	C	D+	C	C
HCM2kAvgQ:	5	1	6	3	2	2	1	6	6	5	4	4

Note: Queue reported is the number of cars per lane.

San Antonio Village Phase III MTA
 SJ21-2068
 Existing PM

Level Of Service Computation Report
 2000 HCM Operations (Future Volume Alternative)
 Existing PP PM

Intersection #12: California Street and Showers Drive

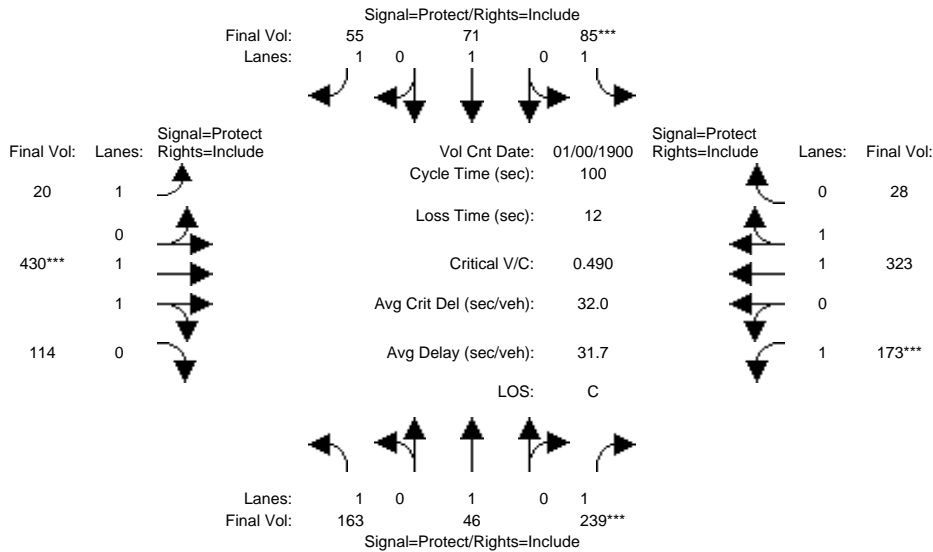

Approach:	North Bound			South Bound			East Bound			West Bound		
Movement:	L	T	R	L	T	R	L	T	R	L	T	R
Min. Green:	7	10	10	7	10	10	7	10	10	7	10	10
Y+R:	4.0	4.0	4.0	4.0	4.0	4.0	4.0	4.0	4.0	4.0	4.0	4.0
Volume Module: >> Count Date: 0 Jan 1900 << 12:00:00 AM												
Base Vol:	163	46	239	85	71	55	20	403	110	173	322	28
Growth Adj:	1.00	1.00	1.00	1.00	1.00	1.00	1.00	1.00	1.00	1.00	1.00	1.00
Initial Bse:	163	46	239	85	71	55	20	403	110	173	322	28
Added Vol:	0	0	0	0	0	0	0	27	4	0	1	0
PasserByVol:	0	0	0	0	0	0	0	0	0	0	0	0
Initial Fut:	163	46	239	85	71	55	20	430	114	173	323	28
User Adj:	1.00	1.00	1.00	1.00	1.00	1.00	1.00	1.00	1.00	1.00	1.00	1.00
PHF Adj:	1.00	1.00	1.00	1.00	1.00	1.00	1.00	1.00	1.00	1.00	1.00	1.00
PHF Volume:	163	46	239	85	71	55	20	430	114	173	323	28
Reduct Vol:	0	0	0	0	0	0	0	0	0	0	0	0
Reduced Vol:	163	46	239	85	71	55	20	430	114	173	323	28
PCE Adj:	1.00	1.00	1.00	1.00	1.00	1.00	1.00	1.00	1.00	1.00	1.00	1.00
MLF Adj:	1.00	1.00	1.00	1.00	1.00	1.00	1.00	1.00	1.00	1.00	1.00	1.00
Final Volume:	163	46	239	85	71	55	20	430	114	173	323	28
Saturation Flow Module:												
Sat/Lane:	1900	1900	1900	1900	1900	1900	1900	1900	1900	1900	1900	1900
Adjustment:	0.92	1.00	0.92	0.92	1.00	0.92	0.92	0.98	0.95	0.92	0.98	0.95
Lanes:	1.00	1.00	1.00	1.00	1.00	1.00	1.00	1.57	0.43	1.00	1.84	0.16
Final Sat.:	1750	1900	1750	1750	1900	1750	1750	2924	775	1750	3405	295
Capacity Analysis Module:												
Vol/Sat:	0.09	0.02	0.14	0.05	0.04	0.03	0.01	0.15	0.15	0.10	0.09	0.09
Crit Moves:			****	****				****		****		
Green Time:	18.2	27.9	27.9	9.9	19.6	19.6	20.7	30.0	30.0	20.2	29.5	29.5
Volume/Cap:	0.51	0.09	0.49	0.49	0.19	0.16	0.06	0.49	0.49	0.49	0.32	0.32
Delay/Veh:	38.3	26.7	30.9	44.8	33.9	33.6	31.9	29.0	29.0	36.4	27.6	27.6
User DelAdj:	1.00	1.00	1.00	1.00	1.00	1.00	1.00	1.00	1.00	1.00	1.00	1.00
AdjDel/Veh:	38.3	26.7	30.9	44.8	33.9	33.6	31.9	29.0	29.0	36.4	27.6	27.6
LOS by Move:	D+	C	C	D	C-	C-	C	C	C	D+	C	C
HCM2kAvgQ:	5	1	6	3	2	2	1	7	7	5	4	4

Note: Queue reported is the number of cars per lane.

San Antonio Village Phase III MTA
 SJ21-2068
 Existing PM

Level Of Service Computation Report
 2000 HCM Operations (Future Volume Alternative)
 Existing PM

Intersection #13: California Street and Ortega Avenue

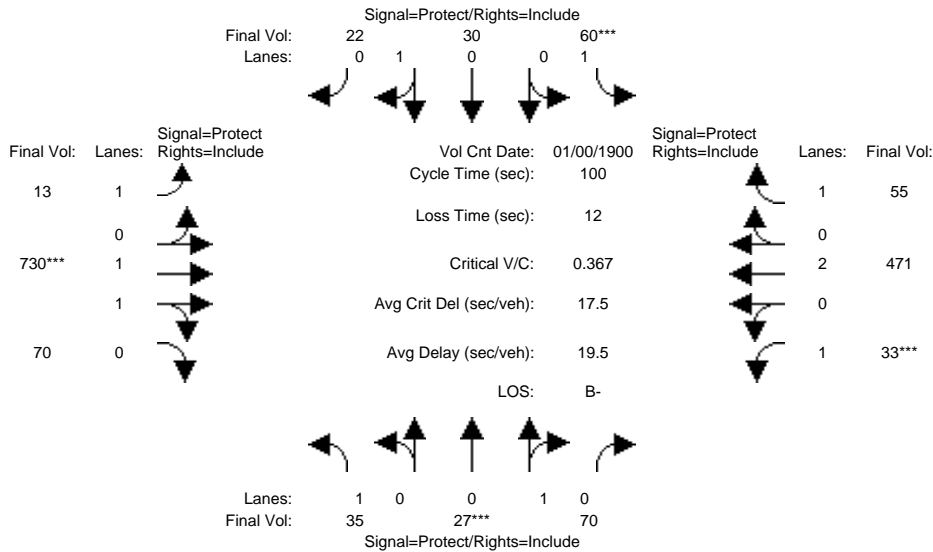

Approach:	North Bound			South Bound			East Bound			West Bound		
Movement:	L	T	R	L	T	R	L	T	R	L	T	R
Min. Green:	7	10	10	7	10	10	7	10	10	7	10	10
Y+R:	4.0	4.0	4.0	4.0	4.0	4.0	4.0	4.0	4.0	4.0	4.0	4.0
Volume Module: >> Count Date: 0 Jan 1900 << 12:00:00 AM												
Base Vol:	35	27	70	60	30	22	13	730	70	33	471	55
Growth Adj:	1.00	1.00	1.00	1.00	1.00	1.00	1.00	1.00	1.00	1.00	1.00	1.00
Initial Bse:	35	27	70	60	30	22	13	730	70	33	471	55
Added Vol:	0	0	0	0	0	0	0	0	0	0	0	0
PasserByVol:	0	0	0	0	0	0	0	0	0	0	0	0
Initial Fut:	35	27	70	60	30	22	13	730	70	33	471	55
User Adj:	1.00	1.00	1.00	1.00	1.00	1.00	1.00	1.00	1.00	1.00	1.00	1.00
PHF Adj:	1.00	1.00	1.00	1.00	1.00	1.00	1.00	1.00	1.00	1.00	1.00	1.00
PHF Volume:	35	27	70	60	30	22	13	730	70	33	471	55
Reduct Vol:	0	0	0	0	0	0	0	0	0	0	0	0
Reduced Vol:	35	27	70	60	30	22	13	730	70	33	471	55
PCE Adj:	1.00	1.00	1.00	1.00	1.00	1.00	1.00	1.00	1.00	1.00	1.00	1.00
MLF Adj:	1.00	1.00	1.00	1.00	1.00	1.00	1.00	1.00	1.00	1.00	1.00	1.00
Final Volume:	35	27	70	60	30	22	13	730	70	33	471	55
Saturation Flow Module:												
Sat/Lane:	1900	1900	1900	1900	1900	1900	1900	1900	1900	1900	1900	1900
Adjustment:	0.92	0.95	0.95	0.92	0.95	0.95	0.92	0.98	0.95	0.92	1.00	0.92
Lanes:	1.00	0.28	0.72	1.00	0.58	0.42	1.00	1.82	0.18	1.00	2.00	1.00
Final Sat.:	1750	501	1299	1750	1038	762	1750	3376	324	1750	3800	1750
Capacity Analysis Module:												
Vol/Sat:	0.02	0.05	0.05	0.03	0.03	0.03	0.01	0.22	0.22	0.02	0.12	0.03
Crit Moves:	****			****			****			****		
Green Time:	9.7	14.3	14.3	9.1	13.8	13.8	23.3	57.5	57.5	7.0	41.2	41.2
Volume/Cap:	0.21	0.38	0.38	0.38	0.21	0.21	0.03	0.38	0.38	0.27	0.30	0.08
Uniform Del:	41.6	38.8	38.8	42.8	38.3	38.3	29.6	11.5	11.5	44.1	19.7	17.8
IncrementDel:	0.6	0.9	0.9	1.5	0.4	0.4	0.0	0.1	0.1	1.2	0.1	0.0
InitQueueDel:	0.0	0.0	0.0	0.0	0.0	0.0	0.0	0.0	0.0	0.0	0.0	0.0
Delay Adj:	1.00	1.00	1.00	1.00	1.00	1.00	1.00	1.00	1.00	1.00	1.00	1.00
Delay/Veh:	42.2	39.7	39.7	44.2	38.7	38.7	29.7	11.6	11.6	45.3	19.8	17.9
User DelAdj:	1.00	1.00	1.00	1.00	1.00	1.00	1.00	1.00	1.00	1.00	1.00	1.00
AdjDel/Veh:	42.2	39.7	39.7	44.2	38.7	38.7	29.7	11.6	11.6	45.3	19.8	17.9
LOS by Move:	D	D	D	D	D+	D+	C	B+	B+	D	B-	B
HCM2kAvgQ:	1	3	3	2	2	2	0	7	7	1	5	1

Note: Queue reported is the number of cars per lane.

San Antonio Village Phase III MTA
 SJ21-2068
 Existing PM

Level Of Service Computation Report
 2000 HCM Operations (Future Volume Alternative)
 Existing PP PM

Intersection #13: California Street and Ortega Avenue

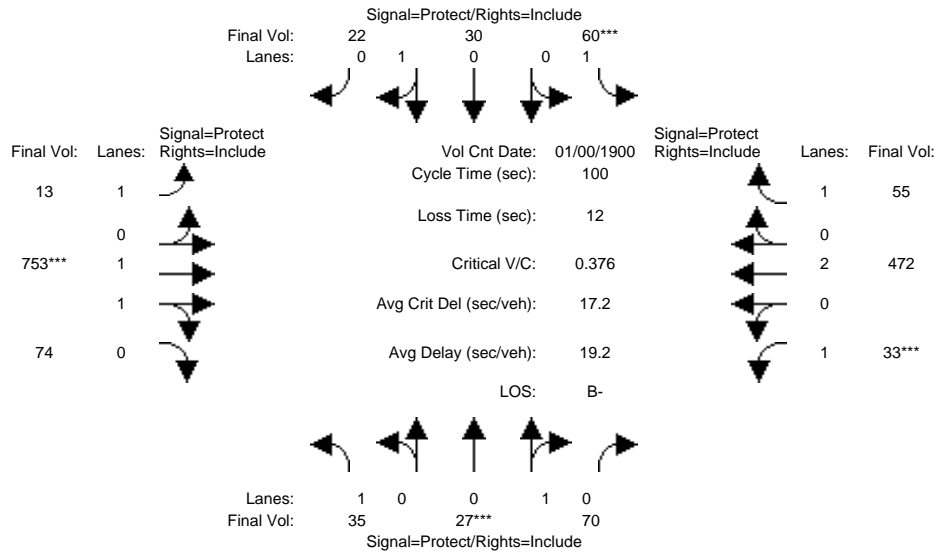

Approach:	North Bound			South Bound			East Bound			West Bound		
	L	T	R	L	T	R	L	T	R	L	T	R
Min. Green:	7	10	10	7	10	10	7	10	10	7	10	10
Y+R:	4.0	4.0	4.0	4.0	4.0	4.0	4.0	4.0	4.0	4.0	4.0	4.0
Volume Module:	>> Count Date: 0 Jan 1900 << 12:00:00 AM											
Base Vol:	35	27	70	60	30	22	13	730	70	33	471	55
Growth Adj:	1.00	1.00	1.00	1.00	1.00	1.00	1.00	1.00	1.00	1.00	1.00	1.00
Initial Bse:	35	27	70	60	30	22	13	730	70	33	471	55
Added Vol:	0	0	0	0	0	0	0	23	4	0	1	0
PasserByVol:	0	0	0	0	0	0	0	0	0	0	0	0
Initial Fut:	35	27	70	60	30	22	13	753	74	33	472	55
User Adj:	1.00	1.00	1.00	1.00	1.00	1.00	1.00	1.00	1.00	1.00	1.00	1.00
PHF Adj:	1.00	1.00	1.00	1.00	1.00	1.00	1.00	1.00	1.00	1.00	1.00	1.00
PHF Volume:	35	27	70	60	30	22	13	753	74	33	472	55
Reduct Vol:	0	0	0	0	0	0	0	0	0	0	0	0
Reduced Vol:	35	27	70	60	30	22	13	753	74	33	472	55
PCE Adj:	1.00	1.00	1.00	1.00	1.00	1.00	1.00	1.00	1.00	1.00	1.00	1.00
MLF Adj:	1.00	1.00	1.00	1.00	1.00	1.00	1.00	1.00	1.00	1.00	1.00	1.00
Final Volume:	35	27	70	60	30	22	13	753	74	33	472	55
Saturation Flow Module:												
Sat/Lane:	1900	1900	1900	1900	1900	1900	1900	1900	1900	1900	1900	1900
Adjustment:	0.92	0.95	0.95	0.92	0.95	0.95	0.92	0.98	0.95	0.92	1.00	0.92
Lanes:	1.00	0.28	0.72	1.00	0.58	0.42	1.00	1.82	0.18	1.00	2.00	1.00
Final Sat.:	1750	501	1299	1750	1038	762	1750	3369	331	1750	3800	1750
Capacity Analysis Module:												
Vol/Sat:	0.02	0.05	0.05	0.03	0.03	0.03	0.01	0.22	0.22	0.02	0.12	0.03
Crit Moves:	****			****			****			****		
Green Time:	9.4	14.0	14.0	8.9	13.5	13.5	23.5	58.1	58.1	7.0	41.6	41.6
Volume/Cap:	0.21	0.38	0.38	0.38	0.21	0.21	0.03	0.38	0.38	0.27	0.30	0.08
Delay/Veh:	42.5	40.1	40.1	44.5	39.0	39.0	29.5	11.4	11.4	45.3	19.6	17.6
User DelAdj:	1.00	1.00	1.00	1.00	1.00	1.00	1.00	1.00	1.00	1.00	1.00	1.00
AdjDel/Veh:	42.5	40.1	40.1	44.5	39.0	39.0	29.5	11.4	11.4	45.3	19.6	17.6
LOS by Move:	D	D	D	D	D+	D+	C	B+	B+	D	B-	B
HCM2kAvgQ:	1	3	3	2	2	2	0	7	7	1	5	1

Note: Queue reported is the number of cars per lane.

San Antonio Village Phase III MTA
 SJ21-2068
 Existing PM

Level Of Service Computation Report
 2000 HCM Operations (Future Volume Alternative)
 Existing PM

Intersection #14: California Street and Rengstorff Avenue

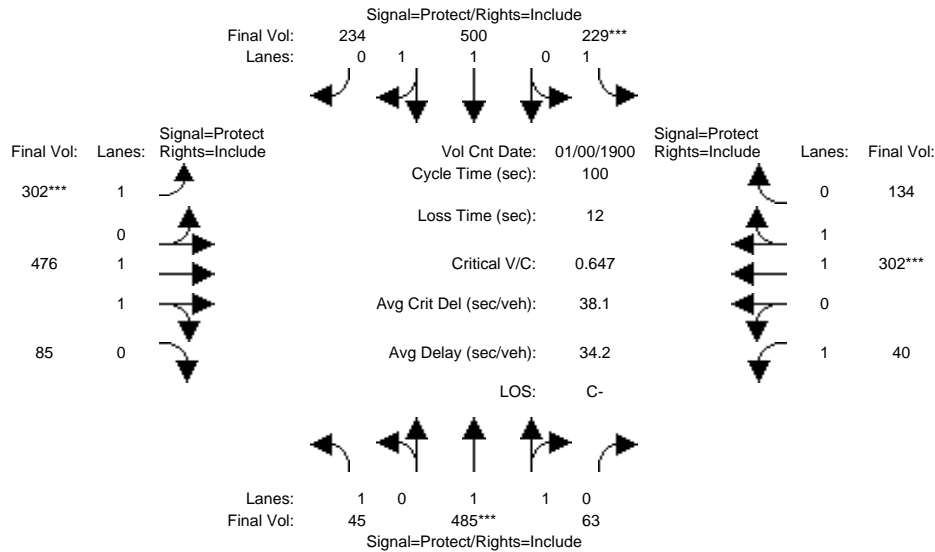

Approach:	North Bound			South Bound			East Bound			West Bound		
	L	T	R	L	T	R	L	T	R	L	T	R
Min. Green:	7	10	10	7	10	10	7	10	10	7	10	10
Y+R:	4.0	4.0	4.0	4.0	4.0	4.0	4.0	4.0	4.0	4.0	4.0	4.0
Volume Module: >> Count Date: 0 Jan 1900 << 12:00:00 AM												
Base Vol:	45	485	63	229	500	234	302	476	85	40	302	134
Growth Adj:	1.00	1.00	1.00	1.00	1.00	1.00	1.00	1.00	1.00	1.00	1.00	1.00
Initial Bse:	45	485	63	229	500	234	302	476	85	40	302	134
Added Vol:	0	0	0	0	0	0	0	0	0	0	0	0
PasserByVol:	0	0	0	0	0	0	0	0	0	0	0	0
Initial Fut:	45	485	63	229	500	234	302	476	85	40	302	134
User Adj:	1.00	1.00	1.00	1.00	1.00	1.00	1.00	1.00	1.00	1.00	1.00	1.00
PHF Adj:	1.00	1.00	1.00	1.00	1.00	1.00	1.00	1.00	1.00	1.00	1.00	1.00
PHF Volume:	45	485	63	229	500	234	302	476	85	40	302	134
Reduct Vol:	0	0	0	0	0	0	0	0	0	0	0	0
Reduced Vol:	45	485	63	229	500	234	302	476	85	40	302	134
PCE Adj:	1.00	1.00	1.00	1.00	1.00	1.00	1.00	1.00	1.00	1.00	1.00	1.00
MLF Adj:	1.00	1.00	1.00	1.00	1.00	1.00	1.00	1.00	1.00	1.00	1.00	1.00
FinalVolume:	45	485	63	229	500	234	302	476	85	40	302	134
Saturation Flow Module:												
Sat/Lane:	1900	1900	1900	1900	1900	1900	1900	1900	1900	1900	1900	1900
Adjustment:	0.92	0.98	0.95	0.92	0.99	0.95	0.92	0.98	0.95	0.92	0.99	0.95
Lanes:	1.00	1.76	0.24	1.00	1.34	0.66	1.00	1.69	0.31	1.00	1.37	0.63
Final Sat.:	1750	3274	425	1750	2520	1179	1750	3139	561	1750	2562	1137
Capacity Analysis Module:												
Vol/Sat:	0.03	0.15	0.15	0.13	0.20	0.20	0.17	0.15	0.15	0.02	0.12	0.12
Crit Moves:	****			****			****			****		
Green Time:	11.2	22.9	22.9	20.2	31.9	31.9	26.7	30.7	30.7	14.2	18.2	18.2
Volume/Cap:	0.23	0.65	0.65	0.65	0.62	0.62	0.65	0.49	0.49	0.16	0.65	0.65
Uniform Del:	40.4	34.9	34.9	36.6	29.0	29.0	32.5	28.3	28.3	37.7	37.9	37.9
IncrementDel:	0.6	1.8	1.8	4.1	1.0	1.0	3.2	0.3	0.3	0.3	2.2	2.2
InitQueueDel:	0.0	0.0	0.0	0.0	0.0	0.0	0.0	0.0	0.0	0.0	0.0	0.0
Delay Adj:	1.00	1.00	1.00	1.00	1.00	1.00	1.00	1.00	1.00	1.00	1.00	1.00
Delay/Veh:	41.0	36.7	36.7	40.8	30.0	30.0	35.7	28.6	28.6	38.0	40.1	40.1
User DelAdj:	1.00	1.00	1.00	1.00	1.00	1.00	1.00	1.00	1.00	1.00	1.00	1.00
AdjDel/Veh:	41.0	36.7	36.7	40.8	30.0	30.0	35.7	28.6	28.6	38.0	40.1	40.1
LOS by Move:	D	D+	D+	D	C	C	D+	C	C	D+	D	D
HCM2kAvgQ:	1	8	8	7	10	10	9	7	7	1	7	7

Note: Queue reported is the number of cars per lane.

San Antonio Village Phase III MTA
 SJ21-2068
 Existing PM

Level Of Service Computation Report
 2000 HCM Operations (Future Volume Alternative)
 Existing PP PM

Intersection #14: California Street and Rengstorff Avenue

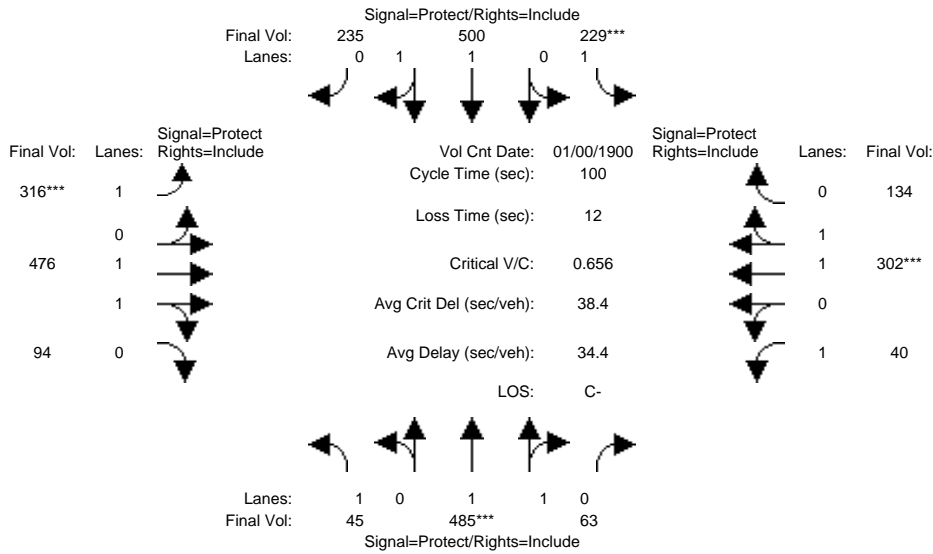

Approach:	North Bound			South Bound			East Bound			West Bound		
Movement:	L	T	R	L	T	R	L	T	R	L	T	R
Min. Green:	7	10	10	7	10	10	7	10	10	7	10	10
Y+R:	4.0	4.0	4.0	4.0	4.0	4.0	4.0	4.0	4.0	4.0	4.0	4.0
Volume Module: >> Count Date: 0 Jan 1900 << 12:00:00 AM												
Base Vol:	45	485	63	229	500	234	302	476	85	40	302	134
Growth Adj:	1.00	1.00	1.00	1.00	1.00	1.00	1.00	1.00	1.00	1.00	1.00	1.00
Initial Bse:	45	485	63	229	500	234	302	476	85	40	302	134
Added Vol:	0	0	0	0	0	1	14	0	9	0	0	0
PasserByVol:	0	0	0	0	0	0	0	0	0	0	0	0
Initial Fut:	45	485	63	229	500	235	316	476	94	40	302	134
User Adj:	1.00	1.00	1.00	1.00	1.00	1.00	1.00	1.00	1.00	1.00	1.00	1.00
PHF Adj:	1.00	1.00	1.00	1.00	1.00	1.00	1.00	1.00	1.00	1.00	1.00	1.00
PHF Volume:	45	485	63	229	500	235	316	476	94	40	302	134
Reduct Vol:	0	0	0	0	0	0	0	0	0	0	0	0
Reduced Vol:	45	485	63	229	500	235	316	476	94	40	302	134
PCE Adj:	1.00	1.00	1.00	1.00	1.00	1.00	1.00	1.00	1.00	1.00	1.00	1.00
MLF Adj:	1.00	1.00	1.00	1.00	1.00	1.00	1.00	1.00	1.00	1.00	1.00	1.00
Final Volume:	45	485	63	229	500	235	316	476	94	40	302	134
Saturation Flow Module:												
Sat/Lane:	1900	1900	1900	1900	1900	1900	1900	1900	1900	1900	1900	1900
Adjustment:	0.92	0.98	0.95	0.92	0.99	0.95	0.92	0.98	0.95	0.92	0.99	0.95
Lanes:	1.00	1.76	0.24	1.00	1.34	0.66	1.00	1.66	0.34	1.00	1.37	0.63
Final Sat.:	1750	3274	425	1750	2516	1183	1750	3089	610	1750	2562	1137
Capacity Analysis Module:												
Vol/Sat:	0.03	0.15	0.15	0.13	0.20	0.20	0.18	0.15	0.15	0.02	0.12	0.12
Crit Moves:	****	****	****	****	****	****	****	****	****	****	****	****
Green Time:	11.1	22.6	22.6	19.9	31.4	31.4	27.5	31.3	31.3	14.2	18.0	18.0
Volume/Cap:	0.23	0.66	0.66	0.66	0.63	0.63	0.66	0.49	0.49	0.16	0.66	0.66
Delay/Veh:	41.2	37.1	37.1	41.4	30.5	30.5	35.3	28.2	28.2	38.0	40.5	40.5
User DelAdj:	1.00	1.00	1.00	1.00	1.00	1.00	1.00	1.00	1.00	1.00	1.00	1.00
AdjDel/Veh:	41.2	37.1	37.1	41.4	30.5	30.5	35.3	28.2	28.2	38.0	40.5	40.5
LOS by Move:	D	D+	D+	D	C	C	D+	C	C	D+	D	D
HCM2kAvgQ:	1	8	8	7	10	10	9	7	7	1	7	7

Note: Queue reported is the number of cars per lane.

San Antonio Village Phase III MTA
 SJ21-2068
 Existing PM

Level Of Service Computation Report
 2000 HCM Operations (Future Volume Alternative)
 Existing PM

Intersection #15: Central Expressway and Rengstorff Avenue

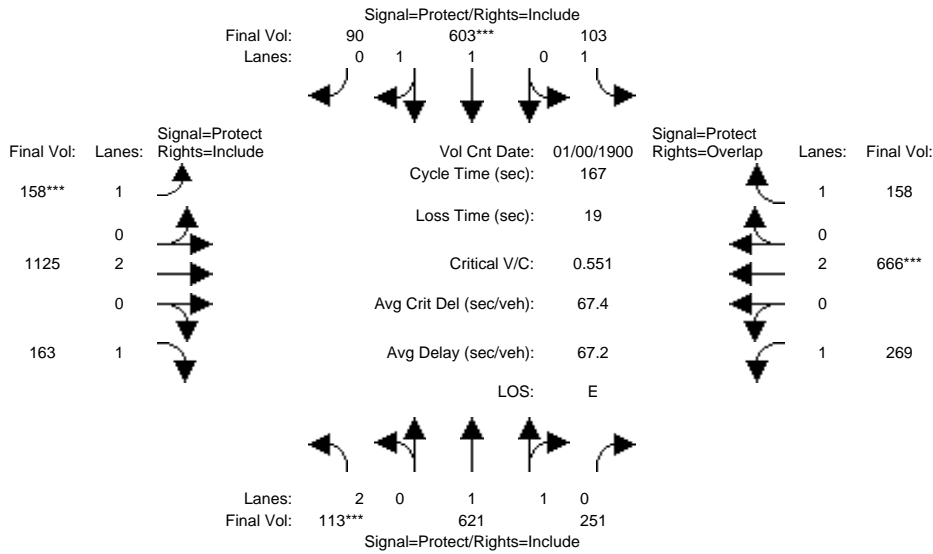

Approach:	North Bound			South Bound			East Bound			West Bound		
	L	T	R	L	T	R	L	T	R	L	T	R
Min. Green:	28	49	49	14	35	35	12	49	49	34	71	71
Y+R:	5.0	5.1	5.1	5.4	5.1	5.1	4.8	5.8	5.8	5.0	5.8	5.8

Volume Module:	>> Count Date: 0 Jan 1900 << 12:00:00 AM											
Base Vol:	113	621	251	103	603	90	158	1125	163	269	666	158
Growth Adj:	1.00	1.00	1.00	1.00	1.00	1.00	1.00	1.00	1.00	1.00	1.00	1.00
Initial Bse:	113	621	251	103	603	90	158	1125	163	269	666	158
Added Vol:	0	0	0	0	0	0	0	0	0	0	0	0
PasserByVol:	0	0	0	0	0	0	0	0	0	0	0	0
Initial Fut:	113	621	251	103	603	90	158	1125	163	269	666	158
User Adj:	1.00	1.00	1.00	1.00	1.00	1.00	1.00	1.00	1.00	1.00	1.00	1.00
PHF Adj:	1.00	1.00	1.00	1.00	1.00	1.00	1.00	1.00	1.00	1.00	1.00	1.00
PHF Volume:	113	621	251	103	603	90	158	1125	163	269	666	158
Reduct Vol:	0	0	0	0	0	0	0	0	0	0	0	0
Reduced Vol:	113	621	251	103	603	90	158	1125	163	269	666	158
PCE Adj:	1.00	1.00	1.00	1.00	1.00	1.00	1.00	1.00	1.00	1.00	1.00	1.00
MLF Adj:	1.00	1.00	1.00	1.00	1.00	1.00	1.00	1.00	1.00	1.00	1.00	1.00
FinalVolume:	113	621	251	103	603	90	158	1125	163	269	666	158

Saturation Flow Module:												
Sat/Lane:	1900	1900	1900	1900	1900	1900	1900	1900	1900	1900	1900	1900
Adjustment:	0.83	0.98	0.95	0.92	0.98	0.95	0.92	1.00	0.92	0.92	1.00	0.92
Lanes:	2.00	1.41	0.59	1.00	1.73	0.27	1.00	2.00	1.00	1.00	2.00	1.00
Final Sat.:	3150	2634	1065	1750	3219	480	1750	3800	1750	1750	3800	1750

Capacity Analysis Module:												
Vol/Sat:	0.04	0.24	0.24	0.06	0.19	0.19	0.09	0.30	0.09	0.15	0.18	0.09
Crit Moves:	****			****			****			****		
Green Time:	28.0	49.0	49.0	14.0	35.0	35.0	14.0	50.4	50.4	34.6	71.0	85.0
Volume/Cap:	0.21	0.80	0.80	0.70	0.89	0.89	1.08	0.98	0.31	0.74	0.41	0.18
Uniform Del:	60.0	54.5	54.5	74.5	64.2	64.2	76.5	57.9	44.9	62.0	33.5	22.1
IncrcmntDel:	0.2	4.4	4.4	14.2	12.8	12.8	96.4	22.2	0.3	7.9	0.2	0.1
InitQueuDel:	0.0	0.0	0.0	0.0	0.0	0.0	0.0	0.0	0.0	0.0	0.0	0.0
Delay Adj:	1.00	1.00	1.00	1.00	1.00	1.00	1.00	1.00	1.00	1.00	1.00	1.00
Delay/Veh:	60.2	59.0	59.0	88.7	77.0	77.0	172.9	80.0	45.2	69.9	33.6	22.2
User DelAdj:	1.00	1.00	1.00	1.00	1.00	1.00	1.00	1.00	1.00	1.00	1.00	1.00
AdjDel/Veh:	60.2	59.0	59.0	88.7	77.0	77.0	172.9	80.0	45.2	69.9	33.6	22.2
LOS by Move:	E	E+	E+	F	E-	E-	F	F	D	E	C-	C+
HCM2kAvgQ:	3	22	22	7	21	21	12	32	7	15	11	5

Note: Queue reported is the number of cars per lane.

San Antonio Village Phase III MTA
 SJ21-2068
 Existing PM

Level Of Service Computation Report
 2000 HCM Operations (Future Volume Alternative)
 Existing PP PM

Intersection #15: Central Expressway and Rengstorff Avenue

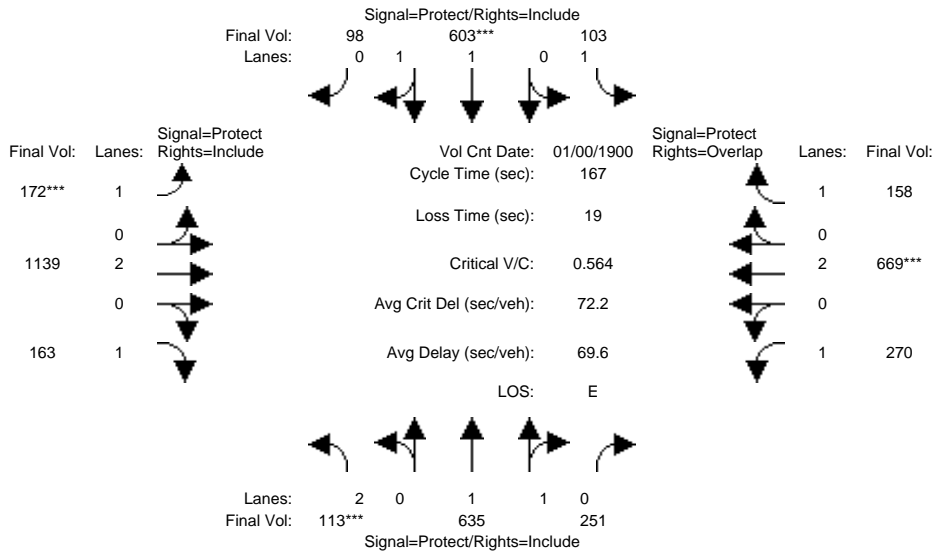

Approach:	North Bound			South Bound			East Bound			West Bound		
	L	T	R	L	T	R	L	T	R	L	T	R
Min. Green:	28	49	49	14	35	35	12	49	49	34	71	71
Y+R:	5.0	5.1	5.1	5.4	5.1	5.1	4.8	5.8	5.8	5.0	5.8	5.8

Volume Module:	>> Count Date: 0 Jan 1900 << 12:00:00 AM											
Base Vol:	113	621	251	103	603	90	158	1125	163	269	666	158
Growth Adj:	1.00	1.00	1.00	1.00	1.00	1.00	1.00	1.00	1.00	1.00	1.00	1.00
Initial Bse:	113	621	251	103	603	90	158	1125	163	269	666	158
Added Vol:	0	14	0	0	0	8	14	14	0	1	3	0
PasserByVol:	0	0	0	0	0	0	0	0	0	0	0	0
Initial Fut:	113	635	251	103	603	98	172	1139	163	270	669	158
User Adj:	1.00	1.00	1.00	1.00	1.00	1.00	1.00	1.00	1.00	1.00	1.00	1.00
PHF Adj:	1.00	1.00	1.00	1.00	1.00	1.00	1.00	1.00	1.00	1.00	1.00	1.00
PHF Volume:	113	635	251	103	603	98	172	1139	163	270	669	158
Reduct Vol:	0	0	0	0	0	0	0	0	0	0	0	0
Reduced Vol:	113	635	251	103	603	98	172	1139	163	270	669	158
PCE Adj:	1.00	1.00	1.00	1.00	1.00	1.00	1.00	1.00	1.00	1.00	1.00	1.00
MLF Adj:	1.00	1.00	1.00	1.00	1.00	1.00	1.00	1.00	1.00	1.00	1.00	1.00
Final Volume:	113	635	251	103	603	98	172	1139	163	270	669	158

Saturation Flow Module:												
Sat/Lane:	1900	1900	1900	1900	1900	1900	1900	1900	1900	1900	1900	1900
Adjustment:	0.83	0.98	0.95	0.92	0.98	0.95	0.92	1.00	0.92	0.92	1.00	0.92
Lanes:	2.00	1.42	0.58	1.00	1.71	0.29	1.00	2.00	1.00	1.00	2.00	1.00
Final Sat.:	3150	2651	1048	1750	3182	517	1750	3800	1750	1750	3800	1750

Capacity Analysis Module:												
Vol/Sat:	0.04	0.24	0.24	0.06	0.19	0.19	0.10	0.30	0.09	0.15	0.18	0.09
Crit Moves:	****			****			****			****		
Green Time:	28.0	49.0	49.0	14.0	35.0	35.0	14.0	50.6	50.6	34.4	71.0	85.0
Volume/Cap:	0.21	0.82	0.82	0.70	0.90	0.90	1.17	0.99	0.31	0.75	0.41	0.18
Delay/Veh:	60.2	59.7	59.7	88.7	78.4	78.4	204.6	81.7	45.0	70.7	33.7	22.2
User DelAdj:	1.00	1.00	1.00	1.00	1.00	1.00	1.00	1.00	1.00	1.00	1.00	1.00
AdjDel/Veh:	60.2	59.7	59.7	88.7	78.4	78.4	204.6	81.7	45.0	70.7	33.7	22.2
LOS by Move:	E	E+	E+	F	E-	E-	F	F	D	E	C-	C+
HCM2kAvgQ:	3	22	22	7	21	21	14	33	7	15	12	5

Note: Queue reported is the number of cars per lane.

San Antonio Village Phase III MTA
 SJ21-2068
 Existing PM

Level Of Service Computation Report
 2000 HCM Operations (Future Volume Alternative)
 Existing PM

Intersection #16: Middlefield Road and San Antonio Road

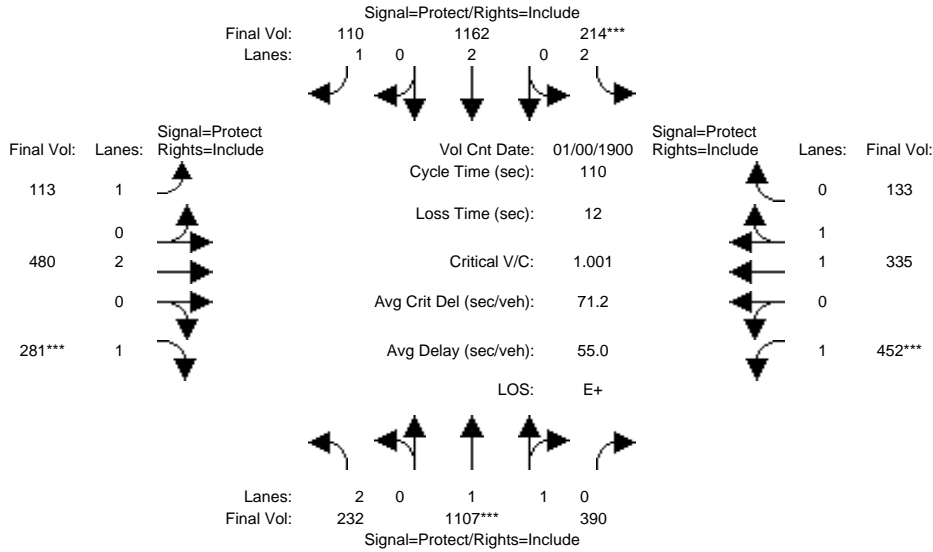

Approach:	North Bound			South Bound			East Bound			West Bound		
	L	T	R	L	T	R	L	T	R	L	T	R
Min. Green:	7	10	10	7	10	10	7	10	10	7	10	10
Y+R:	4.0	4.0	4.0	4.0	4.0	4.0	4.0	4.0	4.0	4.0	4.0	4.0
Volume Module: >> Count Date: 0 Jan 1900 << 12:00:00 AM												
Base Vol:	232	1107	390	214	1162	110	113	480	281	452	335	133
Growth Adj:	1.00	1.00	1.00	1.00	1.00	1.00	1.00	1.00	1.00	1.00	1.00	1.00
Initial Bse:	232	1107	390	214	1162	110	113	480	281	452	335	133
Added Vol:	0	0	0	0	0	0	0	0	0	0	0	0
PasserByVol:	0	0	0	0	0	0	0	0	0	0	0	0
Initial Fut:	232	1107	390	214	1162	110	113	480	281	452	335	133
User Adj:	1.00	1.00	1.00	1.00	1.00	1.00	1.00	1.00	1.00	1.00	1.00	1.00
PHF Adj:	1.00	1.00	1.00	1.00	1.00	1.00	1.00	1.00	1.00	1.00	1.00	1.00
PHF Volume:	232	1107	390	214	1162	110	113	480	281	452	335	133
Reduct Vol:	0	0	0	0	0	0	0	0	0	0	0	0
Reduced Vol:	232	1107	390	214	1162	110	113	480	281	452	335	133
PCE Adj:	1.00	1.00	1.00	1.00	1.00	1.00	1.00	1.00	1.00	1.00	1.00	1.00
MLF Adj:	1.00	1.00	1.00	1.00	1.00	1.00	1.00	1.00	1.00	1.00	1.00	1.00
Final Volume:	232	1107	390	214	1162	110	113	480	281	452	335	133
Saturation Flow Module:												
Sat/Lane:	1900	1900	1900	1900	1900	1900	1900	1900	1900	1900	1900	1900
Adjustment:	0.83	0.98	0.95	0.83	1.00	0.92	0.92	1.00	0.92	0.92	0.98	0.95
Lanes:	2.00	1.46	0.54	2.00	2.00	1.00	1.00	2.00	1.00	1.00	1.42	0.58
Final Sat.:	3150	2735	964	3150	3800	1750	1750	3800	1750	1750	2648	1051
Capacity Analysis Module:												
Vol/Sat:	0.07	0.40	0.40	0.07	0.31	0.06	0.06	0.13	0.16	0.26	0.13	0.13
Crit Moves:	****	****	****	****	****	****	****	****	****	****	****	****
Green Time:	10.1	44.5	44.5	7.5	41.9	41.9	15.6	17.7	17.7	28.4	30.5	30.5
Volume/Cap:	0.80	1.00	1.00	1.00	0.80	0.17	0.46	0.79	1.00	1.00	0.46	0.46
Uniform Del:	49.0	32.8	32.8	51.3	30.4	22.5	43.3	44.4	46.2	40.8	32.9	32.9
IncrcmntDel:	14.9	23.4	23.4	61.7	3.4	0.1	1.3	6.8	53.9	42.5	0.3	0.3
InitQueuDel:	0.0	0.0	0.0	0.0	0.0	0.0	0.0	0.0	0.0	0.0	0.0	0.0
Delay Adj:	1.00	1.00	1.00	1.00	1.00	1.00	1.00	1.00	1.00	1.00	1.00	1.00
Delay/Veh:	63.9	56.2	56.2	113.0	33.7	22.6	44.7	51.1	100.0	83.3	33.2	33.2
User DelAdj:	1.00	1.00	1.00	1.00	1.00	1.00	1.00	1.00	1.00	1.00	1.00	1.00
AdjDel/Veh:	63.9	56.2	56.2	113.0	33.7	22.6	44.7	51.1	100.0	83.3	33.2	33.2
LOS by Move:	E	E+	E+	F	C-	C+	D	D-	F	F	C-	C-
HCM2kAvgQ:	5	31	31	6	18	3	4	10	16	23	7	7

Note: Queue reported is the number of cars per lane.

San Antonio Village Phase III MTA
 SJ21-2068
 Existing PM

Level Of Service Computation Report
 2000 HCM Operations (Future Volume Alternative)
 Existing PP PM

Intersection #16: Middlefield Road and San Antonio Road

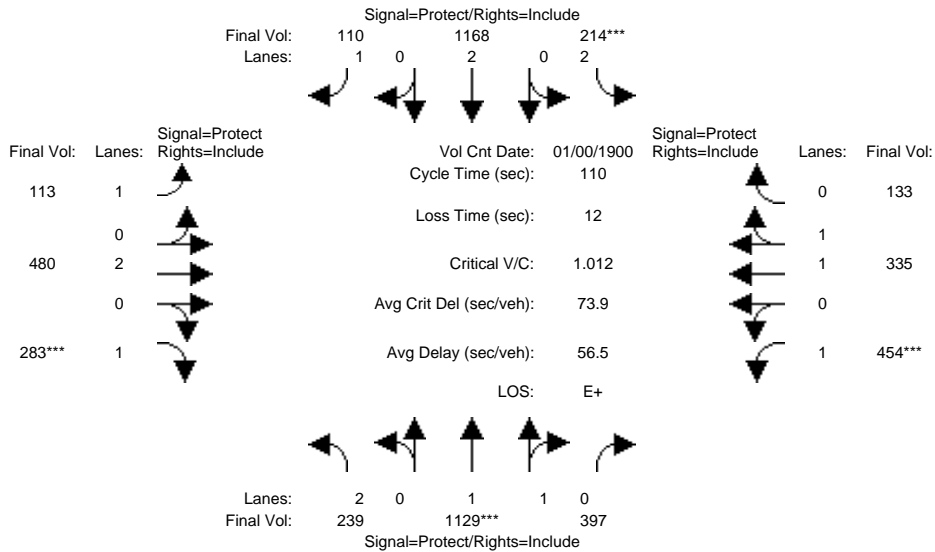

Approach:	North Bound			South Bound			East Bound			West Bound		
	L	T	R	L	T	R	L	T	R	L	T	R
Min. Green:	7	10	10	7	10	10	7	10	10	7	10	10
Y+R:	4.0	4.0	4.0	4.0	4.0	4.0	4.0	4.0	4.0	4.0	4.0	4.0
Volume Module: >> Count Date: 0 Jan 1900 << 12:00:00 AM												
Base Vol:	232	1107	390	214	1162	110	113	480	281	452	335	133
Growth Adj:	1.00	1.00	1.00	1.00	1.00	1.00	1.00	1.00	1.00	1.00	1.00	1.00
Initial Bse:	232	1107	390	214	1162	110	113	480	281	452	335	133
Added Vol:	7	22	7	0	6	0	0	0	2	2	0	0
PasserByVol:	0	0	0	0	0	0	0	0	0	0	0	0
Initial Fut:	239	1129	397	214	1168	110	113	480	283	454	335	133
User Adj:	1.00	1.00	1.00	1.00	1.00	1.00	1.00	1.00	1.00	1.00	1.00	1.00
PHF Adj:	1.00	1.00	1.00	1.00	1.00	1.00	1.00	1.00	1.00	1.00	1.00	1.00
PHF Volume:	239	1129	397	214	1168	110	113	480	283	454	335	133
Reduct Vol:	0	0	0	0	0	0	0	0	0	0	0	0
Reduced Vol:	239	1129	397	214	1168	110	113	480	283	454	335	133
PCE Adj:	1.00	1.00	1.00	1.00	1.00	1.00	1.00	1.00	1.00	1.00	1.00	1.00
MLF Adj:	1.00	1.00	1.00	1.00	1.00	1.00	1.00	1.00	1.00	1.00	1.00	1.00
Final Volume:	239	1129	397	214	1168	110	113	480	283	454	335	133
Saturation Flow Module:												
Sat/Lane:	1900	1900	1900	1900	1900	1900	1900	1900	1900	1900	1900	1900
Adjustment:	0.83	0.98	0.95	0.83	1.00	0.92	0.92	1.00	0.92	0.92	0.98	0.95
Lanes:	2.00	1.47	0.53	2.00	2.00	1.00	1.00	2.00	1.00	1.00	1.42	0.58
Final Sat.:	3150	2737	962	3150	3800	1750	1750	3800	1750	1750	2648	1051
Capacity Analysis Module:												
Vol/Sat:	0.08	0.41	0.41	0.07	0.31	0.06	0.06	0.13	0.16	0.26	0.13	0.13
Crit Moves:	****			****			****			****		
Green Time:	10.3	44.8	44.8	7.4	41.9	41.9	15.5	17.6	17.6	28.2	30.3	30.3
Volume/Cap:	0.81	1.01	1.01	1.01	0.81	0.17	0.46	0.79	1.01	1.01	0.46	0.46
Delay/Veh:	63.9	58.8	58.8	116.3	33.9	22.6	44.8	51.4	103.1	86.4	33.4	33.4
User DelAdj:	1.00	1.00	1.00	1.00	1.00	1.00	1.00	1.00	1.00	1.00	1.00	1.00
AdjDel/Veh:	63.9	58.8	58.8	116.3	33.9	22.6	44.8	51.4	103.1	86.4	33.4	33.4
LOS by Move:	E	E+	E+	F	C-	C+	D	D-	F	F	C-	C-
HCM2kAvgQ:	5	32	32	6	18	3	4	10	16	23	7	7

Note: Queue reported is the number of cars per lane.

San Antonio Village Phase III MTA
 SJ21-2068
 Existing PM

Level Of Service Computation Report
 2000 HCM Operations (Future Volume Alternative)
 Existing PM

Intersection #17: Charleston Road and San Antonio Road

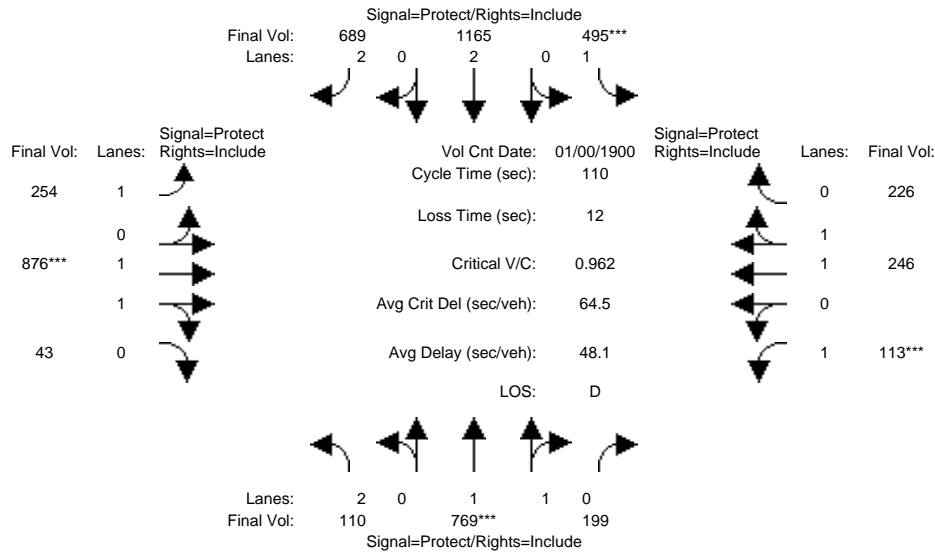

Approach:	North Bound			South Bound			East Bound			West Bound		
	L	T	R	L	T	R	L	T	R	L	T	R
Min. Green:	7	10	10	7	10	10	7	10	10	7	10	10
Y+R:	4.0	4.0	4.0	4.0	4.0	4.0	4.0	4.0	4.0	4.0	4.0	4.0
Volume Module: >> Count Date: 0 Jan 1900 << 12:00:00 AM												
Base Vol:	110	769	199	495	1165	689	254	876	43	113	246	226
Growth Adj:	1.00	1.00	1.00	1.00	1.00	1.00	1.00	1.00	1.00	1.00	1.00	1.00
Initial Bse:	110	769	199	495	1165	689	254	876	43	113	246	226
Added Vol:	0	0	0	0	0	0	0	0	0	0	0	0
PasserByVol:	0	0	0	0	0	0	0	0	0	0	0	0
Initial Fut:	110	769	199	495	1165	689	254	876	43	113	246	226
User Adj:	1.00	1.00	1.00	1.00	1.00	1.00	1.00	1.00	1.00	1.00	1.00	1.00
PHF Adj:	1.00	1.00	1.00	1.00	1.00	1.00	1.00	1.00	1.00	1.00	1.00	1.00
PHF Volume:	110	769	199	495	1165	689	254	876	43	113	246	226
Reduct Vol:	0	0	0	0	0	0	0	0	0	0	0	0
Reduced Vol:	110	769	199	495	1165	689	254	876	43	113	246	226
PCE Adj:	1.00	1.00	1.00	1.00	1.00	1.00	1.00	1.00	1.00	1.00	1.00	1.00
MLF Adj:	1.00	1.00	1.00	1.00	1.00	1.00	1.00	1.00	1.00	1.00	1.00	1.00
Final Volume:	110	769	199	495	1165	689	254	876	43	113	246	226
Saturation Flow Module:												
Sat/Lane:	1900	1900	1900	1900	1900	1900	1900	1900	1900	1900	1900	1900
Adjustment:	0.83	0.98	0.95	0.92	1.00	0.83	0.92	0.97	0.95	0.92	1.00	0.95
Lanes:	2.00	1.58	0.42	1.00	2.00	2.00	1.00	1.90	0.10	1.00	1.02	0.98
Final Sat.:	3150	2939	760	1750	3800	3150	1750	3527	173	1750	1927	1770
Capacity Analysis Module:												
Vol/Sat:	0.03	0.26	0.26	0.28	0.31	0.22	0.15	0.25	0.25	0.06	0.13	0.13
Crit Moves:	****			****			****			****		
Green Time:	10.7	29.9	29.9	32.3	51.5	51.5	19.0	28.4	28.4	7.4	16.7	16.7
Volume/Cap:	0.36	0.96	0.96	0.96	0.65	0.47	0.84	0.96	0.96	0.96	0.84	0.84
Uniform Del:	46.4	39.5	39.5	38.2	22.4	19.9	44.0	40.3	40.3	51.2	45.3	45.3
IncrementDel:	0.7	19.8	19.8	30.2	0.9	0.2	18.3	20.5	20.5	71.0	10.8	10.8
InitQueueDel:	0.0	0.0	0.0	0.0	0.0	0.0	0.0	0.0	0.0	0.0	0.0	0.0
Delay Adj:	1.00	1.00	1.00	1.00	1.00	1.00	1.00	1.00	1.00	1.00	1.00	1.00
Delay/Veh:	47.2	59.3	59.3	68.5	23.3	20.1	62.4	60.8	60.8	122.2	56.1	56.1
User DelAdj:	1.00	1.00	1.00	1.00	1.00	1.00	1.00	1.00	1.00	1.00	1.00	1.00
AdjDel/Veh:	47.2	59.3	59.3	68.5	23.3	20.1	62.4	60.8	60.8	122.2	56.1	56.1
LOS by Move:	D	E+	E+	E	C	C+	E	E	E	F	E+	E+
HCM2kAvgQ:	2	20	20	23	15	10	12	21	21	7	11	11

Note: Queue reported is the number of cars per lane.

San Antonio Village Phase III MTA
 SJ21-2068
 Existing PM

Level Of Service Computation Report
 2000 HCM Operations (Future Volume Alternative)
 Existing PP PM

Intersection #17: Charleston Road and San Antonio Road

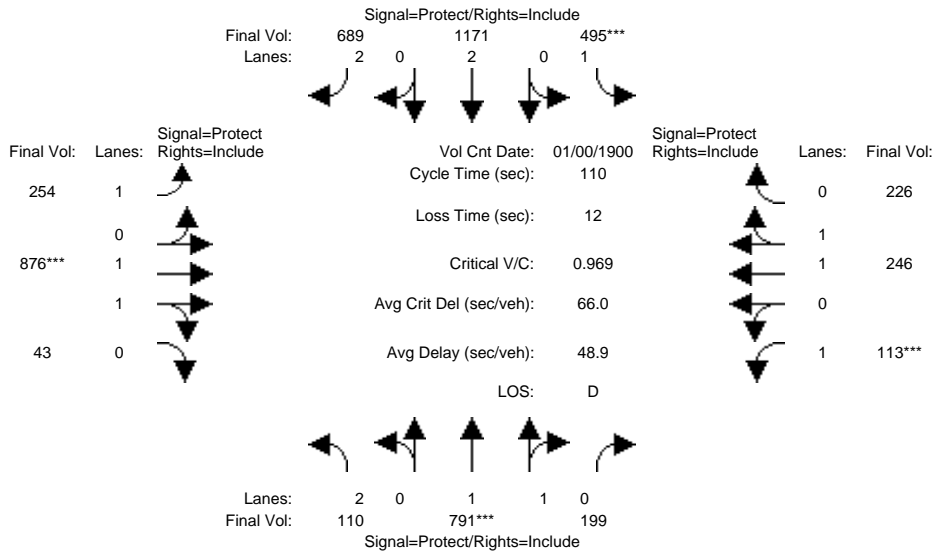

Approach:	North Bound			South Bound			East Bound			West Bound		
	L	T	R	L	T	R	L	T	R	L	T	R
Min. Green:	7	10	10	7	10	10	7	10	10	7	10	10
Y+R:	4.0	4.0	4.0	4.0	4.0	4.0	4.0	4.0	4.0	4.0	4.0	4.0
Volume Module: >> Count Date: 0 Jan 1900 << 12:00:00 AM												
Base Vol:	110	769	199	495	1165	689	254	876	43	113	246	226
Growth Adj:	1.00	1.00	1.00	1.00	1.00	1.00	1.00	1.00	1.00	1.00	1.00	1.00
Initial Bse:	110	769	199	495	1165	689	254	876	43	113	246	226
Added Vol:	0	22	0	0	6	0	0	0	0	0	0	0
PasserByVol:	0	0	0	0	0	0	0	0	0	0	0	0
Initial Fut:	110	791	199	495	1171	689	254	876	43	113	246	226
User Adj:	1.00	1.00	1.00	1.00	1.00	1.00	1.00	1.00	1.00	1.00	1.00	1.00
PHF Adj:	1.00	1.00	1.00	1.00	1.00	1.00	1.00	1.00	1.00	1.00	1.00	1.00
PHF Volume:	110	791	199	495	1171	689	254	876	43	113	246	226
Reduct Vol:	0	0	0	0	0	0	0	0	0	0	0	0
Reduced Vol:	110	791	199	495	1171	689	254	876	43	113	246	226
PCE Adj:	1.00	1.00	1.00	1.00	1.00	1.00	1.00	1.00	1.00	1.00	1.00	1.00
MLF Adj:	1.00	1.00	1.00	1.00	1.00	1.00	1.00	1.00	1.00	1.00	1.00	1.00
Final Volume:	110	791	199	495	1171	689	254	876	43	113	246	226
Saturation Flow Module:												
Sat/Lane:	1900	1900	1900	1900	1900	1900	1900	1900	1900	1900	1900	1900
Adjustment:	0.83	0.98	0.95	0.92	1.00	0.83	0.92	0.97	0.95	0.92	1.00	0.95
Lanes:	2.00	1.59	0.41	1.00	2.00	2.00	1.00	1.90	0.10	1.00	1.02	0.98
Final Sat.:	3150	2956	744	1750	3800	3150	1750	3527	173	1750	1927	1770
Capacity Analysis Module:												
Vol/Sat:	0.03	0.27	0.27	0.28	0.31	0.22	0.15	0.25	0.25	0.06	0.13	0.13
Crit Moves:	****			****			****			****		
Green Time:	10.7	30.4	30.4	32.1	51.8	51.8	18.9	28.2	28.2	7.3	16.6	16.6
Volume/Cap:	0.36	0.97	0.97	0.97	0.65	0.46	0.84	0.97	0.97	0.97	0.84	0.84
Delay/Veh:	47.2	60.3	60.3	70.4	23.2	19.9	63.3	62.4	62.4	124.6	56.8	56.8
User DelAdj:	1.00	1.00	1.00	1.00	1.00	1.00	1.00	1.00	1.00	1.00	1.00	1.00
AdjDel/Veh:	47.2	60.3	60.3	70.4	23.2	19.9	63.3	62.4	62.4	124.6	56.8	56.8
LOS by Move:	D	E	E	E	C	B-	E	E	E	F	E+	E+
HCM2kAvgQ:	2	20	20	23	15	9	12	21	21	7	11	11

Note: Queue reported is the number of cars per lane.

San Antonio Village Phase III MTA
SJ21-2068
Existing PM

Level Of Service Computation Report
2000 HCM Unsignalized (Future Volume Alternative)
Existing PM

Intersection #18: Project Driveway and San Antonio Road

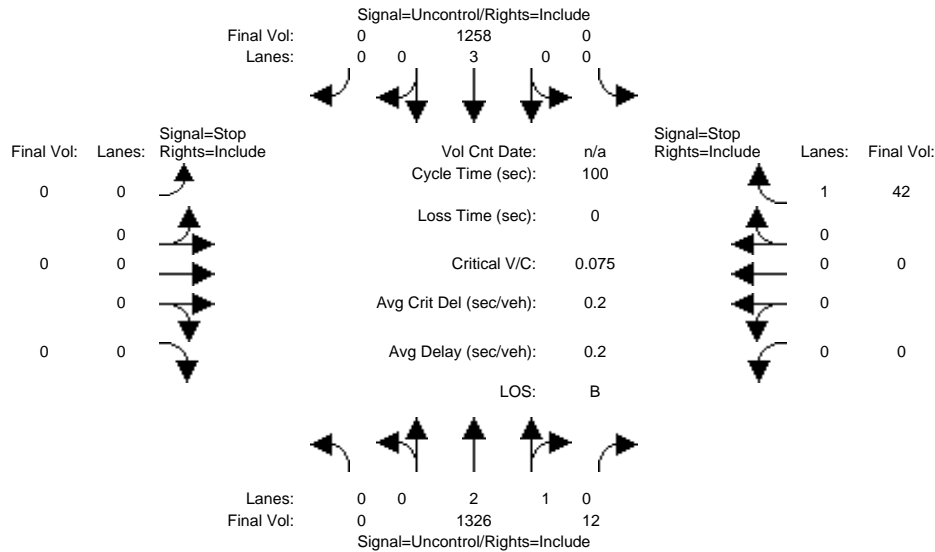

Approach:	North Bound			South Bound			East Bound			West Bound		
Movement:	L	T	R	L	T	R	L	T	R	L	T	R
Volume Module:												
Base Vol:	0	1326	12	0	1258	0	0	0	0	0	0	42
Growth Adj:	1.00	1.00	1.00	1.00	1.00	1.00	1.00	1.00	1.00	1.00	1.00	1.00
Initial Bse:	0	1326	12	0	1258	0	0	0	0	0	0	42
Added Vol:	0	0	0	0	0	0	0	0	0	0	0	0
PasserByVol:	0	0	0	0	0	0	0	0	0	0	0	0
Initial Fut:	0	1326	12	0	1258	0	0	0	0	0	0	42
User Adj:	1.00	1.00	1.00	1.00	1.00	1.00	1.00	1.00	1.00	1.00	1.00	1.00
PHF Adj:	1.00	1.00	1.00	1.00	1.00	1.00	1.00	1.00	1.00	1.00	1.00	1.00
PHF Volume:	0	1326	12	0	1258	0	0	0	0	0	0	42
Reduct Vol:	0	0	0	0	0	0	0	0	0	0	0	0
FinalVolume:	0	1326	12	0	1258	0	0	0	0	0	0	42
Critical Gap Module:												
Critical Gp:	xxxxx	xxxx	xxxxx	xxxxx	xxxx	xxxxx	xxxxx	xxxx	xxxxx	xxxxx	xxxx	6.9
FollowUpTim:	xxxxx	xxxx	xxxxx	xxxxx	xxxx	xxxxx	xxxxx	xxxx	xxxxx	xxxxx	xxxx	3.3
Capacity Module:												
Cnflct Vol:	xxxx	xxxx	xxxxx	xxxx	xxxx	xxxxx	xxxx	xxxx	xxxxx	xxxx	xxxx	448
Potent Cap.:	xxxx	xxxx	xxxxx	xxxx	xxxx	xxxxx	xxxx	xxxx	xxxxx	xxxx	xxxx	564
Move Cap.:	xxxx	xxxx	xxxxx	xxxx	xxxx	xxxxx	xxxx	xxxx	xxxxx	xxxx	xxxx	564
Volume/Cap:	xxxx	xxxx	xxxx	xxxx	xxxx	xxxx	xxxx	xxxx	xxxx	xxxx	xxxx	0.07
Level Of Service Module:												
2Way95thQ:	xxxx	xxxx	xxxxx	xxxx	xxxx	xxxxx	xxxx	xxxx	xxxxx	xxxx	xxxx	0.2
Control Del:	xxxxx	xxxx	xxxxx	xxxxx	xxxx	xxxxx	xxxxx	xxxx	xxxxx	xxxxx	xxxx	11.9
LOS by Move:	*	*	*	*	*	*	*	*	*	*	*	B
Movement:	LT	LTR	RT	LT	LTR	RT	LT	LTR	RT	LT	LTR	RT
Shared Cap.:	xxxx	xxxx	xxxxx	xxxx	xxxx	xxxxx	xxxx	xxxx	xxxxx	xxxx	xxxx	xxxxx
SharedQueue:	xxxxx	xxxx	xxxxx	xxxxx	xxxx	xxxxx	xxxxx	xxxx	xxxxx	xxxxx	xxxx	xxxxx
Shrd ConDel:	xxxxx	xxxx	xxxxx	xxxxx	xxxx	xxxxx	xxxxx	xxxx	xxxxx	xxxxx	xxxx	xxxxx
Shared LOS:	*	*	*	*	*	*	*	*	*	*	*	*
ApproachDel:	xxxxxxx			xxxxxxx			xxxxxxx			11.9		
ApproachLOS:	*			*			*			B		

Note: Queue reported is the number of cars per lane.

San Antonio Village Phase III MTA
 SJ21-2068
 Existing PM

Level Of Service Computation Report
 2000 HCM Unsignalized (Future Volume Alternative)
 Existing PP PM

Intersection #18: Project Driveway and San Antonio Road

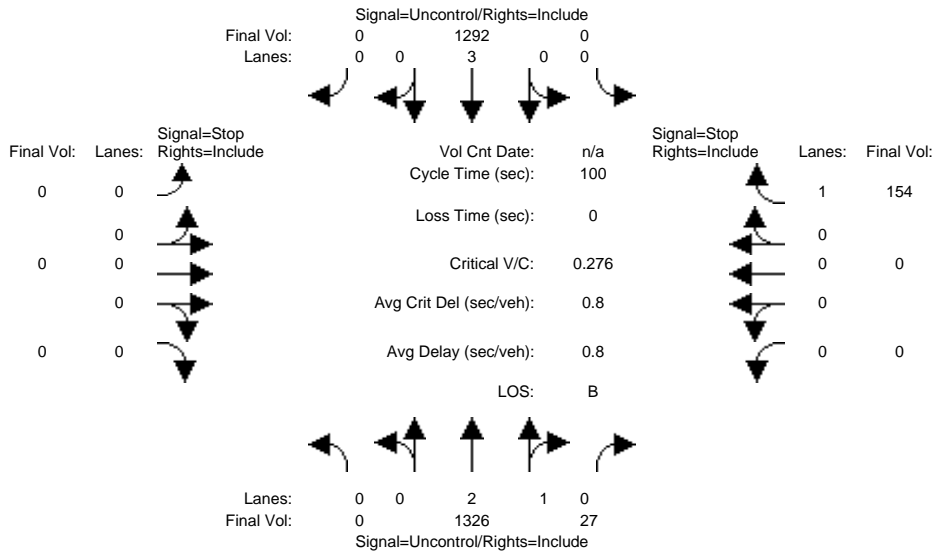

Approach:	North Bound			South Bound			East Bound			West Bound		
Movement:	L	T	R	L	T	R	L	T	R	L	T	R
Volume Module:												
Base Vol:	0	1326	12	0	1258	0	0	0	0	0	0	42
Growth Adj:	1.00	1.00	1.00	1.00	1.00	1.00	1.00	1.00	1.00	1.00	1.00	1.00
Initial Bse:	0	1326	12	0	1258	0	0	0	0	0	0	42
Added Vol:	0	0	15	0	34	0	0	0	0	0	0	112
PasserByVol:	0	0	0	0	0	0	0	0	0	0	0	0
Initial Fut:	0	1326	27	0	1292	0	0	0	0	0	0	154
User Adj:	1.00	1.00	1.00	1.00	1.00	1.00	1.00	1.00	1.00	1.00	1.00	1.00
PHF Adj:	1.00	1.00	1.00	1.00	1.00	1.00	1.00	1.00	1.00	1.00	1.00	1.00
PHF Volume:	0	1326	27	0	1292	0	0	0	0	0	0	154
Reduct Vol:	0	0	0	0	0	0	0	0	0	0	0	0
FinalVolume:	0	1326	27	0	1292	0	0	0	0	0	0	154
Critical Gap Module:												
Critical Gp:	xxxxx	xxxx	xxxxx	xxxxx	xxxx	xxxxx	xxxxx	xxxx	xxxxx	xxxxx	xxxx	6.9
FollowUpTim:	xxxxxx	xxxx	xxxxxx	xxxxxx	xxxx	xxxxxx	xxxxxx	xxxx	xxxxxx	xxxxxx	xxxx	3.3
Capacity Module:												
Cnflct Vol:	xxxx	xxxx	xxxxxx	xxxx	xxxx	xxxxxx	xxxx	xxxx	xxxxxx	xxxx	xxxx	456
Potent Cap.:	xxxx	xxxx	xxxxxx	xxxx	xxxx	xxxxxx	xxxx	xxxx	xxxxxx	xxxx	xxxx	557
Move Cap.:	xxxx	xxxx	xxxxxx	xxxx	xxxx	xxxxxx	xxxx	xxxx	xxxxxx	xxxx	xxxx	557
Volume/Cap:	xxxx	xxxx	xxxx	xxxx	xxxx	xxxx	xxxx	xxxx	xxxx	xxxx	xxxx	0.28
Level Of Service Module:												
2Way95thQ:	xxxx	xxxx	xxxxxx	xxxx	xxxx	xxxxxx	xxxx	xxxx	xxxxxx	xxxx	xxxx	1.1
Control Del:	xxxxxx	xxxx	xxxxxx	xxxxxx	xxxx	xxxxxx	xxxxxx	xxxx	xxxxxx	xxxxxx	xxxx	13.9
LOS by Move:	*	*	*	*	*	*	*	*	*	*	*	B
Movement:	LT	LTR	RT	LT	LTR	RT	LT	LTR	RT	LT	LTR	RT
Shared Cap.:	xxxx	xxxx	xxxxxx	xxxx	xxxx	xxxxxx	xxxx	xxxx	xxxxxx	xxxx	xxxx	xxxxxx
SharedQueue:	xxxxxx	xxxx	xxxxxx	xxxxxx	xxxx	xxxxxx	xxxxxx	xxxx	xxxxxx	xxxxxx	xxxx	xxxxxx
Shrd ConDel:	xxxxxx	xxxx	xxxxxx	xxxxxx	xxxx	xxxxxx	xxxxxx	xxxx	xxxxxx	xxxxxx	xxxx	xxxxxx
Shared LOS:	*	*	*	*	*	*	*	*	*	*	*	*
ApproachDel:	xxxxxxx			xxxxxxx			xxxxxxx					13.9
ApproachLOS:	*			*			*					B

Note: Queue reported is the number of cars per lane.

San Antonio Village Phase III MTA
SJ21-2068
Existing PM

Level Of Service Computation Report
2000 HCM Unsignalized (Future Volume Alternative)
Existing PM

Intersection #19: Project Driveway and California Street

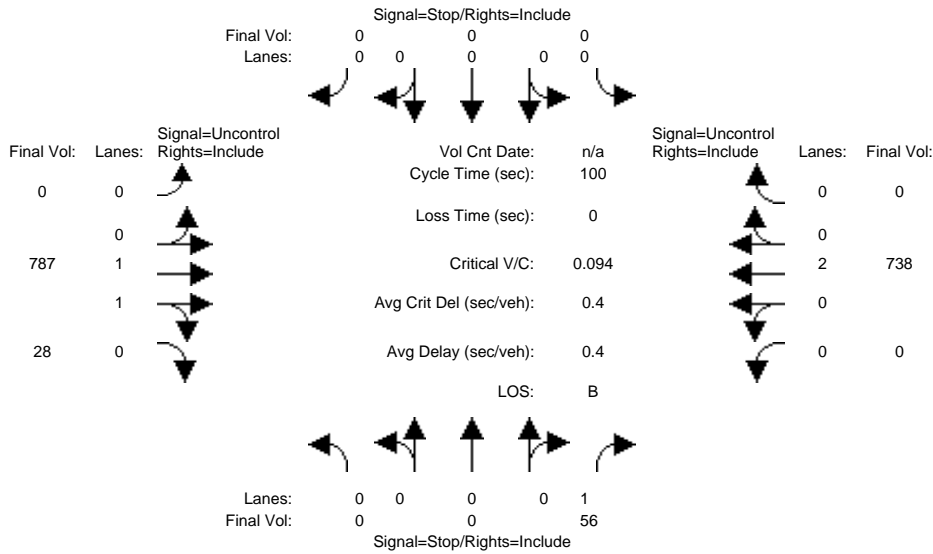

Approach:	North Bound			South Bound			East Bound			West Bound		
Movement:	L	T	R	L	T	R	L	T	R	L	T	R
Volume Module:												
Base Vol:	0	0	56	0	0	0	0	787	28	0	738	0
Growth Adj:	1.00	1.00	1.00	1.00	1.00	1.00	1.00	1.00	1.00	1.00	1.00	1.00
Initial Bse:	0	0	56	0	0	0	0	787	28	0	738	0
Added Vol:	0	0	0	0	0	0	0	0	0	0	0	0
PasserByVol:	0	0	0	0	0	0	0	0	0	0	0	0
Initial Fut:	0	0	56	0	0	0	0	787	28	0	738	0
User Adj:	1.00	1.00	1.00	1.00	1.00	1.00	1.00	1.00	1.00	1.00	1.00	1.00
PHF Adj:	1.00	1.00	1.00	1.00	1.00	1.00	1.00	1.00	1.00	1.00	1.00	1.00
PHF Volume:	0	0	56	0	0	0	0	787	28	0	738	0
Reduct Vol:	0	0	0	0	0	0	0	0	0	0	0	0
FinalVolume:	0	0	56	0	0	0	0	787	28	0	738	0
Critical Gap Module:												
Critical Gp:	xxxxx	xxxx	6.9	xxxxx	xxxx	xxxxx	xxxxx	xxxx	xxxxx	xxxxx	xxxx	xxxxx
FollowUpTim:	xxxxx	xxxx	3.3	xxxxx	xxxx	xxxxx	xxxxx	xxxx	xxxxx	xxxxx	xxxx	xxxxx
Capacity Module:												
Cnflct Vol:	xxxx	xxxx	408	xxxx	xxxx	xxxxx	xxxx	xxxx	xxxxx	xxxx	xxxx	xxxxx
Potent Cap.:	xxxx	xxxx	599	xxxx	xxxx	xxxxx	xxxx	xxxx	xxxxx	xxxx	xxxx	xxxxx
Move Cap.:	xxxx	xxxx	599	xxxx	xxxx	xxxxx	xxxx	xxxx	xxxxx	xxxx	xxxx	xxxxx
Volume/Cap:	xxxx	xxxx	0.09	xxxx	xxxx	xxxx	xxxx	xxxx	xxxx	xxxx	xxxx	xxxx
Level Of Service Module:												
2Way95thQ:	xxxx	xxxx	0.3	xxxx	xxxx	xxxxx	xxxx	xxxx	xxxxx	xxxx	xxxx	xxxxx
Control Del:	xxxxx	xxxx	11.6	xxxxx	xxxx	xxxxx	xxxxx	xxxx	xxxxx	xxxxx	xxxx	xxxxx
LOS by Move:	*	*	B	*	*	*	*	*	*	*	*	*
Movement:	LT	LTR	RT	LT	LTR	RT	LT	LTR	RT	LT	LTR	RT
Shared Cap.:	xxxx	xxxx	xxxxx	xxxx	xxxx	xxxxx	xxxx	xxxx	xxxxx	xxxx	xxxx	xxxxx
SharedQueue:	xxxxx	xxxx	xxxxx	xxxxx	xxxx	xxxxx	xxxxx	xxxx	xxxxx	xxxxx	xxxx	xxxxx
Shrd ConDel:	xxxxx	xxxx	xxxxx	xxxxx	xxxx	xxxxx	xxxxx	xxxx	xxxxx	xxxxx	xxxx	xxxxx
Shared LOS:	*	*	*	*	*	*	*	*	*	*	*	*
ApproachDel:	11.6			xxxxxxx			xxxxxxx			xxxxxxx		
ApproachLOS:	B			*			*			*		

Note: Queue reported is the number of cars per lane.

San Antonio Village Phase III MTA
 SJ21-2068
 Existing PM

Level Of Service Computation Report
 2000 HCM Unsignalized (Future Volume Alternative)
 Existing PP PM

Intersection #19: Project Driveway and California Street

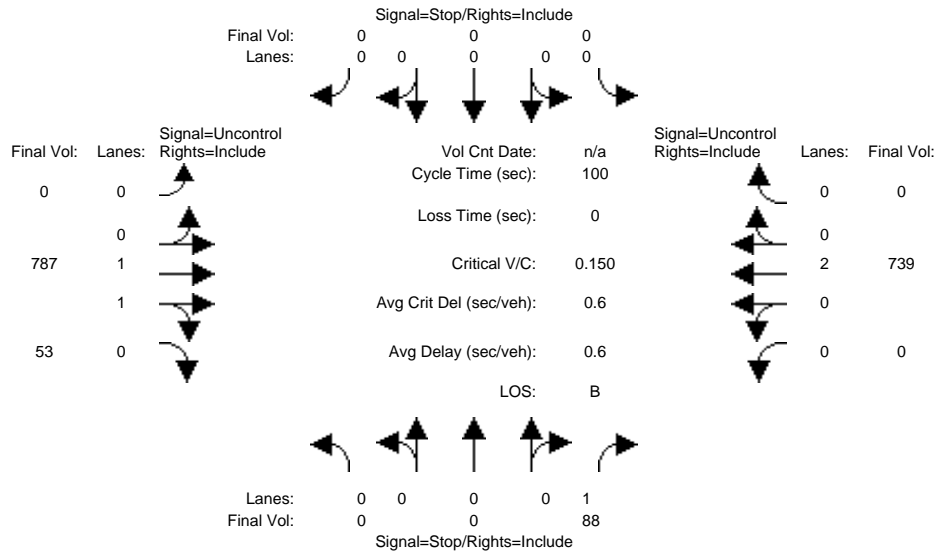

Approach:	North Bound			South Bound			East Bound			West Bound		
Movement:	L	T	R	L	T	R	L	T	R	L	T	R
Volume Module:												
Base Vol:	0	0	56	0	0	0	0	787	28	0	738	0
Growth Adj:	1.00	1.00	1.00	1.00	1.00	1.00	1.00	1.00	1.00	1.00	1.00	1.00
Initial Bse:	0	0	56	0	0	0	0	787	28	0	738	0
Added Vol:	0	0	32	0	0	0	0	0	25	0	1	0
PasserByVol:	0	0	0	0	0	0	0	0	0	0	0	0
Initial Fut:	0	0	88	0	0	0	0	787	53	0	739	0
User Adj:	1.00	1.00	1.00	1.00	1.00	1.00	1.00	1.00	1.00	1.00	1.00	1.00
PHF Adj:	1.00	1.00	1.00	1.00	1.00	1.00	1.00	1.00	1.00	1.00	1.00	1.00
PHF Volume:	0	0	88	0	0	0	0	787	53	0	739	0
Reduct Vol:	0	0	0	0	0	0	0	0	0	0	0	0
FinalVolume:	0	0	88	0	0	0	0	787	53	0	739	0
Critical Gap Module:												
Critical Gp:	xxxxx	xxxx	6.9	xxxxx	xxxx	xxxxx	xxxxx	xxxx	xxxxx	xxxxx	xxxx	xxxxx
FollowUpTim:	xxxxx	xxxx	3.3	xxxxx	xxxx	xxxxx	xxxxx	xxxx	xxxxx	xxxxx	xxxx	xxxxx
Capacity Module:												
Cnflct Vol:	xxxx	xxxx	420	xxxx	xxxx	xxxxx	xxxx	xxxx	xxxxx	xxxx	xxxx	xxxxx
Potent Cap.:	xxxx	xxxx	588	xxxx	xxxx	xxxxx	xxxx	xxxx	xxxxx	xxxx	xxxx	xxxxx
Move Cap.:	xxxx	xxxx	588	xxxx	xxxx	xxxxx	xxxx	xxxx	xxxxx	xxxx	xxxx	xxxxx
Volume/Cap:	xxxx	xxxx	0.15	xxxx	xxxx	xxxx	xxxx	xxxx	xxxx	xxxx	xxxx	xxxx
Level Of Service Module:												
2Way95thQ:	xxxx	xxxx	0.5	xxxx	xxxx	xxxxx	xxxx	xxxx	xxxxx	xxxx	xxxx	xxxxx
Control Del:	xxxxx	xxxx	12.2	xxxxx	xxxx	xxxxx	xxxxx	xxxx	xxxxx	xxxxx	xxxx	xxxxx
LOS by Move:	*	*	B	*	*	*	*	*	*	*	*	*
Movement:	LT	LTR	RT	LT	LTR	RT	LT	LTR	RT	LT	LTR	RT
Shared Cap.:	xxxx	xxxx	xxxxx	xxxx	xxxx	xxxxx	xxxx	xxxx	xxxxx	xxxx	xxxx	xxxxx
SharedQueue:	xxxxx	xxxx	xxxxx	xxxxx	xxxx	xxxxx	xxxxx	xxxx	xxxxx	xxxxx	xxxx	xxxxx
Shrd ConDel:	xxxxx	xxxx	xxxxx	xxxxx	xxxx	xxxxx	xxxxx	xxxx	xxxxx	xxxxx	xxxx	xxxxx
Shared LOS:	*	*	*	*	*	*	*	*	*	*	*	*
ApproachDel:	12.2			xxxxxxx			xxxxxxx			xxxxxxx		
ApproachLOS:	B			*			*			*		

Note: Queue reported is the number of cars per lane.

San Antonio Village Phase III MTA
 SJ21-2068
 Background AM

Level Of Service Computation Report
 2000 HCM Operations (Future Volume Alternative)
 Background AM

Intersection #1: El Camino Real and Arastradero Road-Charleston Road

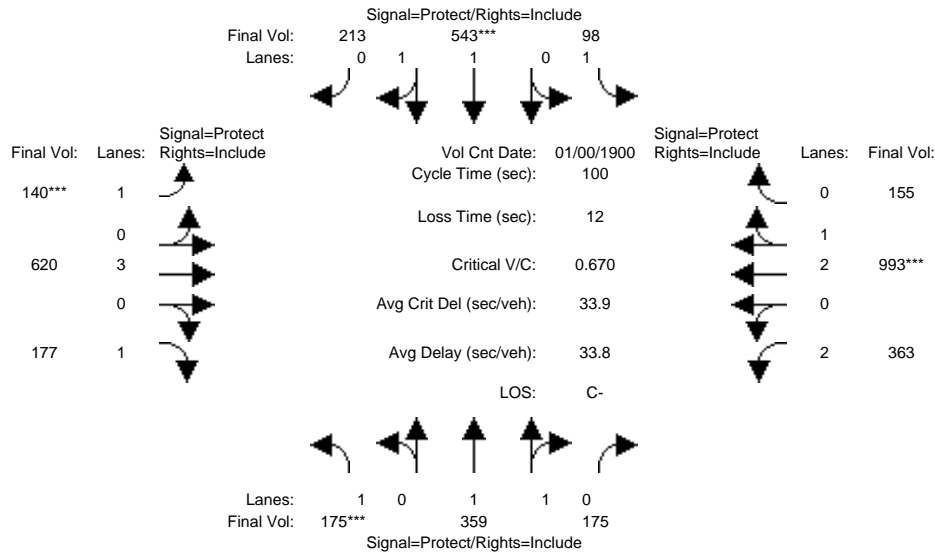

Approach:	North Bound			South Bound			East Bound			West Bound		
	L	T	R	L	T	R	L	T	R	L	T	R
Min. Green:	7	10	10	7	10	10	7	10	10	7	10	10
Y+R:	4.0	4.0	4.0	4.0	4.0	4.0	4.0	4.0	4.0	4.0	4.0	4.0

Volume Module:	>>	Count	Date:	0	Jan	1900	<<	12:00:00	AM			
Base Vol:	175	359	173	98	543	213	140	604	177	351	951	155
Growth Adj:	1.00	1.00	1.00	1.00	1.00	1.00	1.00	1.00	1.00	1.00	1.00	1.00
Initial Bse:	175	359	173	98	543	213	140	604	177	351	951	155
Added Vol:	0	0	2	0	0	0	0	16	0	12	42	0
PasserByVol:	0	0	0	0	0	0	0	0	0	0	0	0
Initial Fut:	175	359	175	98	543	213	140	620	177	363	993	155
User Adj:	1.00	1.00	1.00	1.00	1.00	1.00	1.00	1.00	1.00	1.00	1.00	1.00
PHF Adj:	1.00	1.00	1.00	1.00	1.00	1.00	1.00	1.00	1.00	1.00	1.00	1.00
PHF Volume:	175	359	175	98	543	213	140	620	177	363	993	155
Reduct Vol:	0	0	0	0	0	0	0	0	0	0	0	0
Reduced Vol:	175	359	175	98	543	213	140	620	177	363	993	155
PCE Adj:	1.00	1.00	1.00	1.00	1.00	1.00	1.00	1.00	1.00	1.00	1.00	1.00
MLF Adj:	1.00	1.00	1.00	1.00	1.00	1.00	1.00	1.00	1.00	1.00	1.00	1.00
Final Volume:	175	359	175	98	543	213	140	620	177	363	993	155

Saturation Flow Module:												
Sat/Lane:	1900	1900	1900	1900	1900	1900	1900	1900	1900	1900	1900	1900
Adjustment:	0.92	0.99	0.95	0.92	0.98	0.95	0.92	1.00	0.92	0.83	0.99	0.95
Lanes:	1.00	1.33	0.67	1.00	1.42	0.58	1.00	3.00	1.00	2.00	2.58	0.42
Final Sat.:	1750	2487	1212	1750	2657	1042	1750	5700	1750	3150	4843	756

Capacity Analysis Module:												
Vol/Sat:	0.10	0.14	0.14	0.06	0.20	0.20	0.08	0.11	0.10	0.12	0.21	0.21
Crit Moves:	****			****			****			****		
Green Time:	14.9	30.6	30.6	14.8	30.5	30.5	11.9	20.7	20.7	21.9	30.6	30.6
Volume/Cap:	0.67	0.47	0.47	0.38	0.67	0.67	0.67	0.53	0.49	0.53	0.67	0.67
Uniform Del:	40.2	28.1	28.1	38.4	30.3	30.3	42.1	35.3	35.0	34.5	30.3	30.3
IncrcmntDel:	6.6	0.3	0.3	0.9	1.6	1.6	8.1	0.4	1.0	0.8	1.0	1.0
InitQueueDel:	0.0	0.0	0.0	0.0	0.0	0.0	0.0	0.0	0.0	0.0	0.0	0.0
Delay Adj:	1.00	1.00	1.00	1.00	1.00	1.00	1.00	1.00	1.00	1.00	1.00	1.00
Delay/Veh:	46.8	28.5	28.5	39.3	31.9	31.9	50.3	35.8	36.1	35.2	31.3	31.3
User DelAdj:	1.00	1.00	1.00	1.00	1.00	1.00	1.00	1.00	1.00	1.00	1.00	1.00
AdjDel/Veh:	46.8	28.5	28.5	39.3	31.9	31.9	50.3	35.8	36.1	35.2	31.3	31.3
LOS by Move:	D	C	C	D	C	C	D	D+	D+	D+	C	C
HCM2kAvgQ:	7	7	7	3	11	11	6	6	6	6	11	11

Note: Queue reported is the number of cars per lane.

San Antonio Village Phase III MTA
 SJ21-2068
 Background AM

Level Of Service Computation Report
 2000 HCM Operations (Future Volume Alternative)
 Background PP AM

Intersection #1: El Camino Real and Arastradero Road-Charleston Road

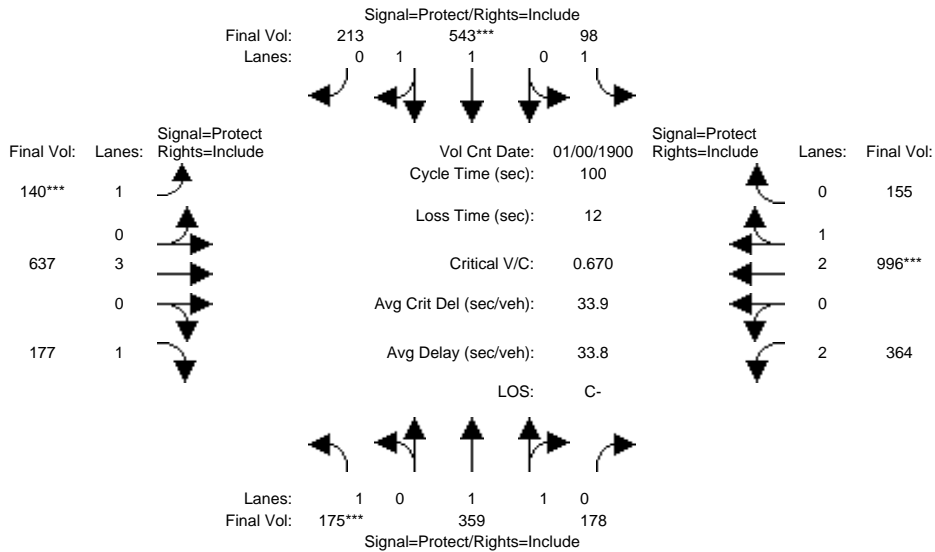

Approach:	North Bound			South Bound			East Bound			West Bound		
	L	T	R	L	T	R	L	T	R	L	T	R
Min. Green:	7	10	10	7	10	10	7	10	10	7	10	10
Y+R:	4.0	4.0	4.0	4.0	4.0	4.0	4.0	4.0	4.0	4.0	4.0	4.0
Volume Module: >> Count Date: 0 Jan 1900 << 12:00:00 AM												
Base Vol:	175	359	173	98	543	213	140	604	177	351	951	155
Growth Adj:	1.00	1.00	1.00	1.00	1.00	1.00	1.00	1.00	1.00	1.00	1.00	1.00
Initial Bse:	175	359	173	98	543	213	140	604	177	351	951	155
Added Vol:	0	0	5	0	0	0	0	33	0	13	45	0
PasserByVol:	0	0	0	0	0	0	0	0	0	0	0	0
Initial Fut:	175	359	178	98	543	213	140	637	177	364	996	155
User Adj:	1.00	1.00	1.00	1.00	1.00	1.00	1.00	1.00	1.00	1.00	1.00	1.00
PHF Adj:	1.00	1.00	1.00	1.00	1.00	1.00	1.00	1.00	1.00	1.00	1.00	1.00
PHF Volume:	175	359	178	98	543	213	140	637	177	364	996	155
Reduct Vol:	0	0	0	0	0	0	0	0	0	0	0	0
Reduced Vol:	175	359	178	98	543	213	140	637	177	364	996	155
PCE Adj:	1.00	1.00	1.00	1.00	1.00	1.00	1.00	1.00	1.00	1.00	1.00	1.00
MLF Adj:	1.00	1.00	1.00	1.00	1.00	1.00	1.00	1.00	1.00	1.00	1.00	1.00
FinalVolume:	175	359	178	98	543	213	140	637	177	364	996	155
Saturation Flow Module:												
Sat/Lane:	1900	1900	1900	1900	1900	1900	1900	1900	1900	1900	1900	1900
Adjustment:	0.92	0.99	0.95	0.92	0.98	0.95	0.92	1.00	0.92	0.83	0.99	0.95
Lanes:	1.00	1.32	0.68	1.00	1.42	0.58	1.00	3.00	1.00	2.00	2.58	0.42
Final Sat.:	1750	2473	1226	1750	2657	1042	1750	5700	1750	3150	4845	754
Capacity Analysis Module:												
Vol/Sat:	0.10	0.15	0.15	0.06	0.20	0.20	0.08	0.11	0.10	0.12	0.21	0.21
Crit Moves:	****			****			****			****		
Green Time:	14.9	30.6	30.6	14.8	30.5	30.5	11.9	20.9	20.9	21.7	30.7	30.7
Volume/Cap:	0.67	0.47	0.47	0.38	0.67	0.67	0.67	0.53	0.48	0.53	0.67	0.67
Delay/Veh:	46.8	28.5	28.5	39.4	32.0	32.0	50.3	35.7	35.8	35.5	31.3	31.3
User DelAdj:	1.00	1.00	1.00	1.00	1.00	1.00	1.00	1.00	1.00	1.00	1.00	1.00
AdjDel/Veh:	46.8	28.5	28.5	39.4	32.0	32.0	50.3	35.7	35.8	35.5	31.3	31.3
LOS by Move:	D	C	C	D	C	C	D	D+	D+	D+	C	C
HCM2kAvgQ:	7	7	7	3	11	11	6	6	6	6	11	11

Note: Queue reported is the number of cars per lane.

San Antonio Village Phase III MTA
 SJ21-2068
 Background AM

Level Of Service Computation Report
 2000 HCM Operations (Future Volume Alternative)
 Background AM

Intersection #2: El Camino Real and Del Medio Avenue

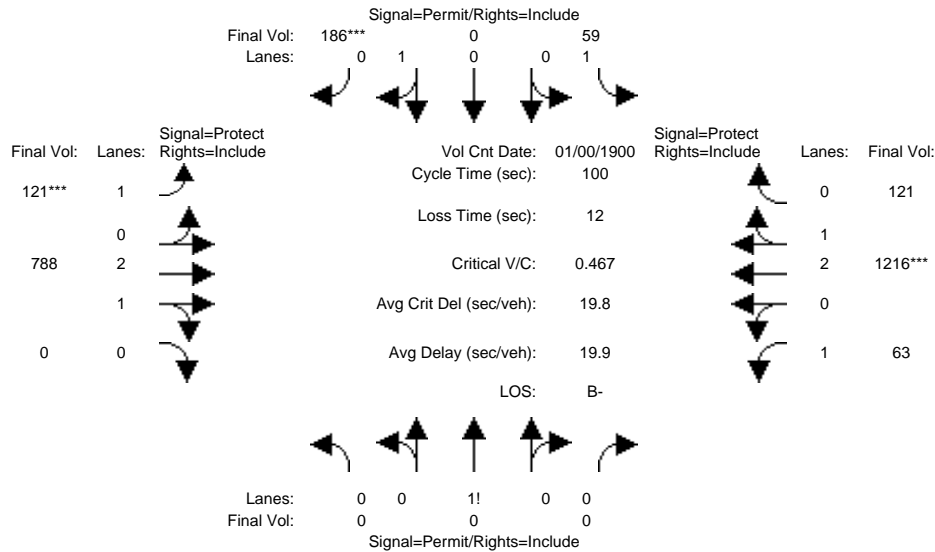

Approach:	North Bound			South Bound			East Bound			West Bound		
Movement:	L	T	R	L	T	R	L	T	R	L	T	R
Min. Green:	10	10	10	10	10	10	7	10	10	7	10	10
Y+R:	4.0	4.0	4.0	4.0	4.0	4.0	4.0	4.0	4.0	4.0	4.0	4.0
Volume Module: >> Count Date: 0 Jan 1900 << 12:00:00 AM												
Base Vol:	0	0	0	59	0	186	121	762	0	63	1165	121
Growth Adj:	1.00	1.00	1.00	1.00	1.00	1.00	1.00	1.00	1.00	1.00	1.00	1.00
Initial Bse:	0	0	0	59	0	186	121	762	0	63	1165	121
Added Vol:	0	0	0	0	0	0	0	26	0	0	51	0
PasserByVol:	0	0	0	0	0	0	0	0	0	0	0	0
Initial Fut:	0	0	0	59	0	186	121	788	0	63	1216	121
User Adj:	1.00	1.00	1.00	1.00	1.00	1.00	1.00	1.00	1.00	1.00	1.00	1.00
PHF Adj:	1.00	1.00	1.00	1.00	1.00	1.00	1.00	1.00	1.00	1.00	1.00	1.00
PHF Volume:	0	0	0	59	0	186	121	788	0	63	1216	121
Reduct Vol:	0	0	0	0	0	0	0	0	0	0	0	0
Reduced Vol:	0	0	0	59	0	186	121	788	0	63	1216	121
PCE Adj:	1.00	1.00	1.00	1.00	1.00	1.00	1.00	1.00	1.00	1.00	1.00	1.00
MLF Adj:	1.00	1.00	1.00	1.00	1.00	1.00	1.00	1.00	1.00	1.00	1.00	1.00
FinalVolume:	0	0	0	59	0	186	121	788	0	63	1216	121
Saturation Flow Module:												
Sat/Lane:	1900	1900	1900	1900	1900	1900	1900	1900	1900	1900	1900	1900
Adjustment:	0.92	0.92	0.92	0.92	1.00	0.95	0.92	0.98	0.92	0.92	0.99	0.95
Lanes:	0.00	1.00	0.00	1.00	0.00	1.00	1.00	3.00	0.00	1.00	2.72	0.28
Final Sat.:	0	1750	0	1750	0	1800	1750	5600	0	1750	5093	507
Capacity Analysis Module:												
Vol/Sat:	0.00	0.00	0.00	0.03	0.00	0.10	0.07	0.14	0.00	0.04	0.24	0.24
Crit Moves:						****	****			****		
Green Time:	0.0	0.0	0.0	22.1	0.0	22.1	14.8	44.0	0.0	21.9	51.1	51.1
Volume/Cap:	0.00	0.00	0.00	0.15	0.00	0.47	0.47	0.32	0.00	0.16	0.47	0.47
Uniform Del:	0.0	0.0	0.0	31.4	0.0	33.8	39.0	18.2	0.0	31.6	15.7	15.7
IncrcmntDel:	0.0	0.0	0.0	0.2	0.0	0.9	1.3	0.1	0.0	0.2	0.1	0.1
InitQueuDel:	0.0	0.0	0.0	0.0	0.0	0.0	0.0	0.0	0.0	0.0	0.0	0.0
Delay Adj:	0.00	0.00	0.00	1.00	0.00	1.00	1.00	1.00	0.00	1.00	1.00	1.00
Delay/Veh:	0.0	0.0	0.0	31.6	0.0	34.7	40.3	18.3	0.0	31.8	15.8	15.8
User DelAdj:	1.00	1.00	1.00	1.00	1.00	1.00	1.00	1.00	1.00	1.00	1.00	1.00
AdjDel/Veh:	0.0	0.0	0.0	31.6	0.0	34.7	40.3	18.3	0.0	31.8	15.8	15.8
LOS by Move:	A	A	A	C	A	C-	D	B-	A	C	B	B
HCM2kAvgQ:	0	0	0	2	0	6	4	5	0	2	9	9

Note: Queue reported is the number of cars per lane.

San Antonio Village Phase III MTA
 SJ21-2068
 Background AM

Level Of Service Computation Report
 2000 HCM Operations (Future Volume Alternative)
 Background PP AM

Intersection #2: El Camino Real and Del Medio Avenue

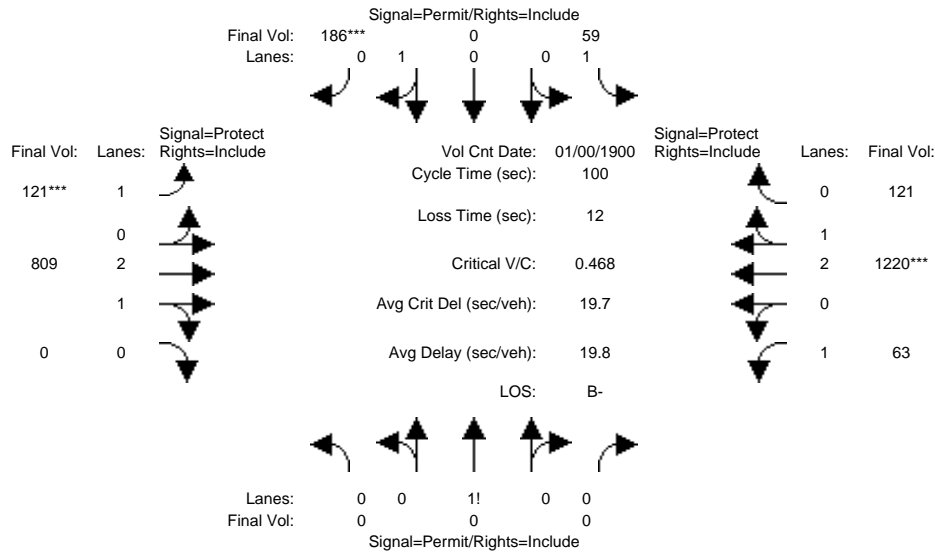

Approach:	North Bound			South Bound			East Bound			West Bound		
	L	T	R	L	T	R	L	T	R	L	T	R
Min. Green:	10	10	10	10	10	10	7	10	10	7	10	10
Y+R:	4.0	4.0	4.0	4.0	4.0	4.0	4.0	4.0	4.0	4.0	4.0	4.0
Volume Module: >> Count Date: 0 Jan 1900 << 12:00:00 AM												
Base Vol:	0	0	0	59	0	186	121	762	0	63	1165	121
Growth Adj:	1.00	1.00	1.00	1.00	1.00	1.00	1.00	1.00	1.00	1.00	1.00	1.00
Initial Bse:	0	0	0	59	0	186	121	762	0	63	1165	121
Added Vol:	0	0	0	0	0	0	0	47	0	0	55	0
PasserByVol:	0	0	0	0	0	0	0	0	0	0	0	0
Initial Fut:	0	0	0	59	0	186	121	809	0	63	1220	121
User Adj:	1.00	1.00	1.00	1.00	1.00	1.00	1.00	1.00	1.00	1.00	1.00	1.00
PHF Adj:	1.00	1.00	1.00	1.00	1.00	1.00	1.00	1.00	1.00	1.00	1.00	1.00
PHF Volume:	0	0	0	59	0	186	121	809	0	63	1220	121
Reduct Vol:	0	0	0	0	0	0	0	0	0	0	0	0
Reduced Vol:	0	0	0	59	0	186	121	809	0	63	1220	121
PCE Adj:	1.00	1.00	1.00	1.00	1.00	1.00	1.00	1.00	1.00	1.00	1.00	1.00
MLF Adj:	1.00	1.00	1.00	1.00	1.00	1.00	1.00	1.00	1.00	1.00	1.00	1.00
FinalVolume:	0	0	0	59	0	186	121	809	0	63	1220	121
Saturation Flow Module:												
Sat/Lane:	1900	1900	1900	1900	1900	1900	1900	1900	1900	1900	1900	1900
Adjustment:	0.92	0.92	0.92	0.92	1.00	0.95	0.92	0.98	0.92	0.92	0.99	0.95
Lanes:	0.00	1.00	0.00	1.00	0.00	1.00	1.00	3.00	0.00	1.00	2.72	0.28
Final Sat.:	0	1750	0	1750	0	1800	1750	5600	0	1750	5094	505
Capacity Analysis Module:												
Vol/Sat:	0.00	0.00	0.00	0.03	0.00	0.10	0.07	0.14	0.00	0.04	0.24	0.24
Crit Moves:				****			****			****		
Green Time:	0.0	0.0	0.0	22.1	0.0	22.1	14.8	44.4	0.0	21.5	51.2	51.2
Volume/Cap:	0.00	0.00	0.00	0.15	0.00	0.47	0.47	0.33	0.00	0.17	0.47	0.47
Delay/Veh:	0.0	0.0	0.0	31.6	0.0	34.7	40.4	18.1	0.0	32.2	15.8	15.8
User DelAdj:	1.00	1.00	1.00	1.00	1.00	1.00	1.00	1.00	1.00	1.00	1.00	1.00
AdjDel/Veh:	0.0	0.0	0.0	31.6	0.0	34.7	40.4	18.1	0.0	32.2	15.8	15.8
LOS by Move:	A	A	A	C	A	C-	D	B-	A	C-	B	B
HCM2kAvgQ:	0	0	0	2	0	6	4	5	0	2	9	9

Note: Queue reported is the number of cars per lane.

San Antonio Village Phase III MTA
 SJ21-2068
 Background AM

Level Of Service Computation Report
 2000 HCM Operations (Future Volume Alternative)
 Background AM

Intersection #3: El Camino Real and San Antonio Road

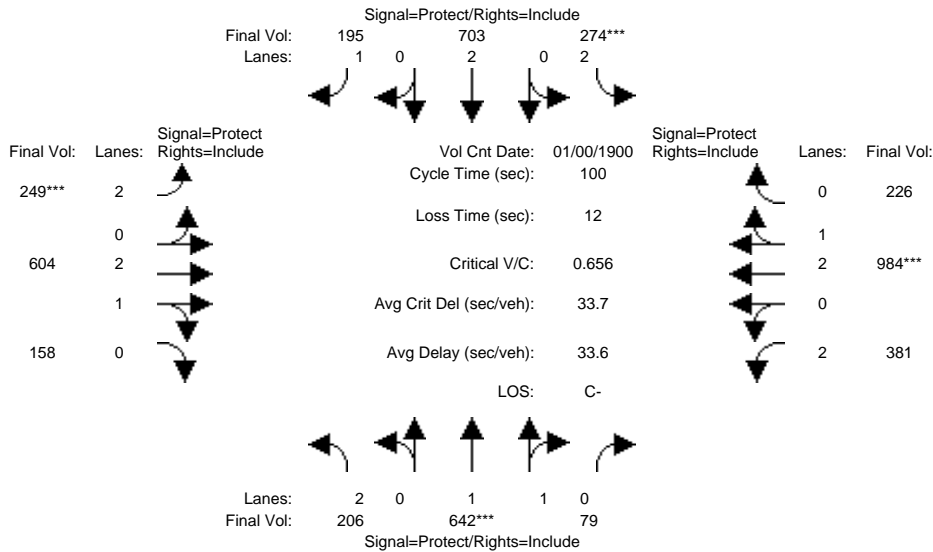

Approach:	North Bound			South Bound			East Bound			West Bound		
	L	T	R	L	T	R	L	T	R	L	T	R
Min. Green:	7	10	10	7	10	10	7	10	10	7	10	10
Y+R:	4.0	4.0	4.0	4.0	4.0	4.0	4.0	4.0	4.0	4.0	4.0	4.0
Volume Module: >> Count Date: 0 Jan 1900 << 12:00:00 AM												
Base Vol:	199	631	70	247	675	167	241	594	149	366	968	199
Growth Adj:	1.00	1.00	1.00	1.00	1.00	1.00	1.00	1.00	1.00	1.00	1.00	1.00
Initial Bse:	199	631	70	247	675	167	241	594	149	366	968	199
Added Vol:	7	11	9	27	28	28	8	10	9	15	16	27
PasserByVol:	0	0	0	0	0	0	0	0	0	0	0	0
Initial Fut:	206	642	79	274	703	195	249	604	158	381	984	226
User Adj:	1.00	1.00	1.00	1.00	1.00	1.00	1.00	1.00	1.00	1.00	1.00	1.00
PHF Adj:	1.00	1.00	1.00	1.00	1.00	1.00	1.00	1.00	1.00	1.00	1.00	1.00
PHF Volume:	206	642	79	274	703	195	249	604	158	381	984	226
Reduct Vol:	0	0	0	0	0	0	0	0	0	0	0	0
Reduced Vol:	206	642	79	274	703	195	249	604	158	381	984	226
PCE Adj:	1.00	1.00	1.00	1.00	1.00	1.00	1.00	1.00	1.00	1.00	1.00	1.00
MLF Adj:	1.00	1.00	1.00	1.00	1.00	1.00	1.00	1.00	1.00	1.00	1.00	1.00
Final Volume:	206	642	79	274	703	195	249	604	158	381	984	226
Saturation Flow Module:												
Sat/Lane:	1900	1900	1900	1900	1900	1900	1900	1900	1900	1900	1900	1900
Adjustment:	0.83	0.98	0.95	0.83	1.00	0.92	0.83	0.99	0.95	0.83	0.99	0.95
Lanes:	2.00	1.77	0.23	2.00	2.00	1.00	2.00	2.36	0.64	2.00	2.42	0.58
Final Sat.:	3150	3294	405	3150	3800	1750	3150	4437	1161	3150	4553	1046
Capacity Analysis Module:												
Vol/Sat:	0.07	0.19	0.19	0.09	0.19	0.11	0.08	0.14	0.14	0.12	0.22	0.22
Crit Moves:	****			****			****			****		
Green Time:	11.8	29.7	29.7	13.3	31.2	31.2	12.1	23.8	23.8	21.2	33.0	33.0
Volume/Cap:	0.55	0.66	0.66	0.66	0.59	0.36	0.66	0.57	0.57	0.57	0.66	0.66
Uniform Del:	41.6	30.7	30.7	41.2	29.1	26.6	42.0	33.6	33.6	35.3	28.7	28.7
IncrementDel:	1.8	1.4	1.4	3.8	0.8	0.4	4.1	0.6	0.6	1.2	0.9	0.9
InitQueueDel:	0.0	0.0	0.0	0.0	0.0	0.0	0.0	0.0	0.0	0.0	0.0	0.0
Delay Adj:	1.00	1.00	1.00	1.00	1.00	1.00	1.00	1.00	1.00	1.00	1.00	1.00
Delay/Veh:	43.4	32.1	32.1	45.0	29.9	27.0	46.1	34.2	34.2	36.5	29.5	29.5
User DelAdj:	1.00	1.00	1.00	1.00	1.00	1.00	1.00	1.00	1.00	1.00	1.00	1.00
AdjDel/Veh:	43.4	32.1	32.1	45.0	29.9	27.0	46.1	34.2	34.2	36.5	29.5	29.5
LOS by Move:	D	C-	C-	D	C	C	D	C-	C-	D+	C	C
HCM2kAvgQ:	4	11	11	5	9	5	5	7	7	7	12	12

Note: Queue reported is the number of cars per lane.

San Antonio Village Phase III MTA
 SJ21-2068
 Background AM

Level Of Service Computation Report
 2000 HCM Operations (Future Volume Alternative)
 Background PP AM

Intersection #3: El Camino Real and San Antonio Road

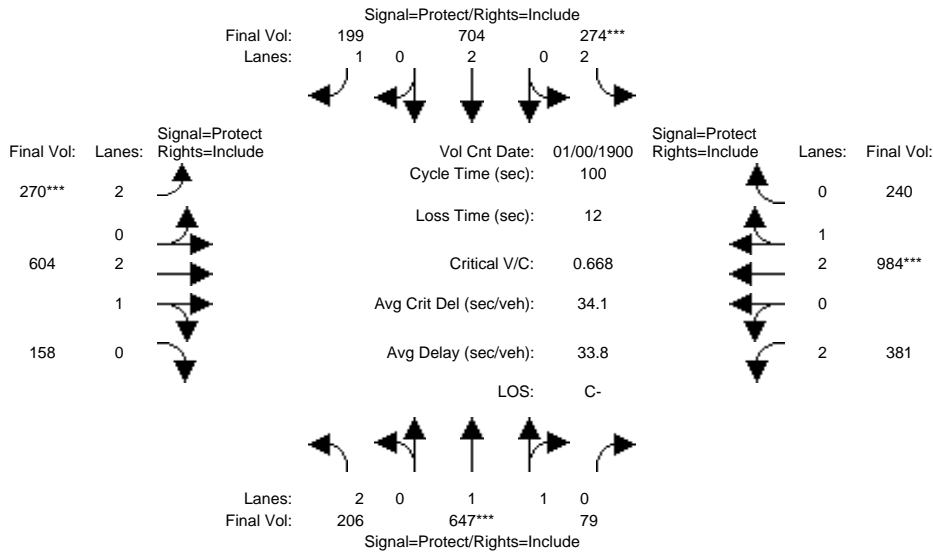

Approach:	North Bound			South Bound			East Bound			West Bound		
	L	T	R	L	T	R	L	T	R	L	T	R
Min. Green:	7	10	10	7	10	10	7	10	10	7	10	10
Y+R:	4.0	4.0	4.0	4.0	4.0	4.0	4.0	4.0	4.0	4.0	4.0	4.0
Volume Module: >> Count Date: 0 Jan 1900 << 12:00:00 AM												
Base Vol:	199	631	70	247	675	167	241	594	149	366	968	199
Growth Adj:	1.00	1.00	1.00	1.00	1.00	1.00	1.00	1.00	1.00	1.00	1.00	1.00
Initial Bse:	199	631	70	247	675	167	241	594	149	366	968	199
Added Vol:	7	16	9	27	29	32	29	10	9	15	16	41
PasserByVol:	0	0	0	0	0	0	0	0	0	0	0	0
Initial Fut:	206	647	79	274	704	199	270	604	158	381	984	240
User Adj:	1.00	1.00	1.00	1.00	1.00	1.00	1.00	1.00	1.00	1.00	1.00	1.00
PHF Adj:	1.00	1.00	1.00	1.00	1.00	1.00	1.00	1.00	1.00	1.00	1.00	1.00
PHF Volume:	206	647	79	274	704	199	270	604	158	381	984	240
Reduct Vol:	0	0	0	0	0	0	0	0	0	0	0	0
Reduced Vol:	206	647	79	274	704	199	270	604	158	381	984	240
PCE Adj:	1.00	1.00	1.00	1.00	1.00	1.00	1.00	1.00	1.00	1.00	1.00	1.00
MLF Adj:	1.00	1.00	1.00	1.00	1.00	1.00	1.00	1.00	1.00	1.00	1.00	1.00
Final Volume:	206	647	79	274	704	199	270	604	158	381	984	240
Saturation Flow Module:												
Sat/Lane:	1900	1900	1900	1900	1900	1900	1900	1900	1900	1900	1900	1900
Adjustment:	0.83	0.98	0.95	0.83	1.00	0.92	0.83	0.99	0.95	0.83	0.99	0.95
Lanes:	2.00	1.78	0.22	2.00	2.00	1.00	2.00	2.36	0.64	2.00	2.39	0.61
Final Sat.:	3150	3297	403	3150	3800	1750	3150	4437	1161	3150	4501	1098
Capacity Analysis Module:												
Vol/Sat:	0.07	0.20	0.20	0.09	0.19	0.11	0.09	0.14	0.14	0.12	0.22	0.22
Crit Moves:	****	****	****	****	****	****	****	****	****	****	****	****
Green Time:	11.6	29.4	29.4	13.0	30.8	30.8	12.8	24.1	24.1	21.4	32.7	32.7
Volume/Cap:	0.56	0.67	0.67	0.67	0.60	0.37	0.67	0.56	0.56	0.56	0.67	0.67
Delay/Veh:	43.8	32.6	32.6	45.6	30.3	27.5	45.8	33.9	33.9	36.2	29.9	29.9
User DelAdj:	1.00	1.00	1.00	1.00	1.00	1.00	1.00	1.00	1.00	1.00	1.00	1.00
AdjDel/Veh:	43.8	32.6	32.6	45.6	30.3	27.5	45.8	33.9	33.9	36.2	29.9	29.9
LOS by Move:	D	C-	C-	D	C	C	D	C-	C-	D+	C	C
HCM2kAvgQ:	4	11	11	5	9	5	5	7	7	7	12	12

Note: Queue reported is the number of cars per lane.

San Antonio Village Phase III MTA
 SJ21-2068
 Background AM

Level Of Service Computation Report
 2000 HCM Operations (Future Volume Alternative)
 Background AM

Intersection #4: El Camino Real and Showers Drive

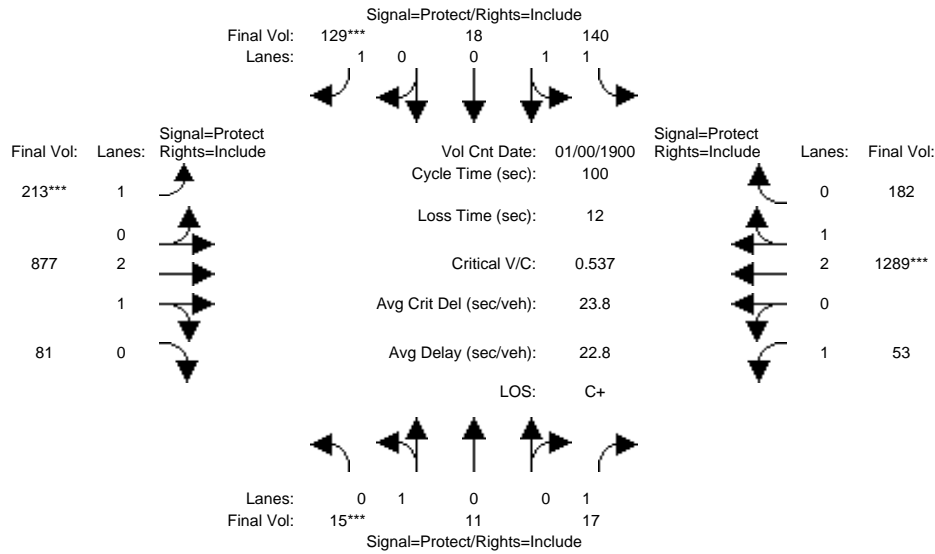

Approach:	North Bound			South Bound			East Bound			West Bound		
Movement:	L	T	R	L	T	R	L	T	R	L	T	R
Min. Green:	7	10	10	7	10	10	7	10	10	7	10	10
Y+R:	4.0	4.0	4.0	4.0	4.0	4.0	4.0	4.0	4.0	4.0	4.0	4.0
Volume Module: >> Count Date: 0 Jan 1900 << 12:00:00 AM												
Base Vol:	15	11	17	140	18	129	213	832	81	53	1231	182
Growth Adj:	1.00	1.00	1.00	1.00	1.00	1.00	1.00	1.00	1.00	1.00	1.00	1.00
Initial Bse:	15	11	17	140	18	129	213	832	81	53	1231	182
Added Vol:	0	0	0	0	0	0	0	45	0	0	58	0
PasserByVol:	0	0	0	0	0	0	0	0	0	0	0	0
Initial Fut:	15	11	17	140	18	129	213	877	81	53	1289	182
User Adj:	1.00	1.00	1.00	1.00	1.00	1.00	1.00	1.00	1.00	1.00	1.00	1.00
PHF Adj:	1.00	1.00	1.00	1.00	1.00	1.00	1.00	1.00	1.00	1.00	1.00	1.00
PHF Volume:	15	11	17	140	18	129	213	877	81	53	1289	182
Reduct Vol:	0	0	0	0	0	0	0	0	0	0	0	0
Reduced Vol:	15	11	17	140	18	129	213	877	81	53	1289	182
PCE Adj:	1.00	1.00	1.00	1.00	1.00	1.00	1.00	1.00	1.00	1.00	1.00	1.00
MLF Adj:	1.00	1.00	1.00	1.00	1.00	1.00	1.00	1.00	1.00	1.00	1.00	1.00
Final Volume:	15	11	17	140	18	129	213	877	81	53	1289	182
Saturation Flow Module:												
Sat/Lane:	1900	1900	1900	1900	1900	1900	1900	1900	1900	1900	1900	1900
Adjustment:	0.95	0.95	0.92	0.93	0.95	0.92	0.92	0.99	0.95	0.92	0.99	0.95
Lanes:	0.58	0.42	1.00	1.78	0.22	1.00	1.00	2.74	0.26	1.00	2.62	0.38
Final Sat.:	1038	762	1750	3145	404	1750	1750	5126	473	1750	4906	693
Capacity Analysis Module:												
Vol/Sat:	0.01	0.01	0.01	0.04	0.04	0.07	0.12	0.17	0.17	0.03	0.26	0.26
Crit Moves:	****					****	****			****		
Green Time:	7.0	11.8	11.8	8.2	13.0	13.0	21.5	48.2	48.2	19.7	46.4	46.4
Volume/Cap:	0.21	0.12	0.08	0.54	0.34	0.57	0.57	0.35	0.35	0.15	0.57	0.57
Uniform Del:	43.9	39.5	39.3	44.1	39.6	40.8	35.1	16.2	16.2	33.2	19.4	19.4
IncrementDel:	0.8	0.3	0.2	2.0	0.4	3.3	2.0	0.1	0.1	0.2	0.3	0.3
InitQueueDel:	0.0	0.0	0.0	0.0	0.0	0.0	0.0	0.0	0.0	0.0	0.0	0.0
Delay Adj:	1.00	1.00	1.00	1.00	1.00	1.00	1.00	1.00	1.00	1.00	1.00	1.00
Delay/Veh:	44.7	39.7	39.5	46.1	40.0	44.1	37.1	16.2	16.2	33.4	19.7	19.7
User DelAdj:	1.00	1.00	1.00	1.00	1.00	1.00	1.00	1.00	1.00	1.00	1.00	1.00
AdjDel/Veh:	44.7	39.7	39.5	46.1	40.0	44.1	37.1	16.2	16.2	33.4	19.7	19.7
LOS by Move:	D	D	D	D	D	D	D+	B	B	C-	B-	B-
HCM2kAvgQ:	1	1	1	3	2	4	7	6	6	2	11	11

Note: Queue reported is the number of cars per lane.

San Antonio Village Phase III MTA
 SJ21-2068
 Background AM

Level Of Service Computation Report
 2000 HCM Operations (Future Volume Alternative)
 Background PP AM

Intersection #4: El Camino Real and Showers Drive

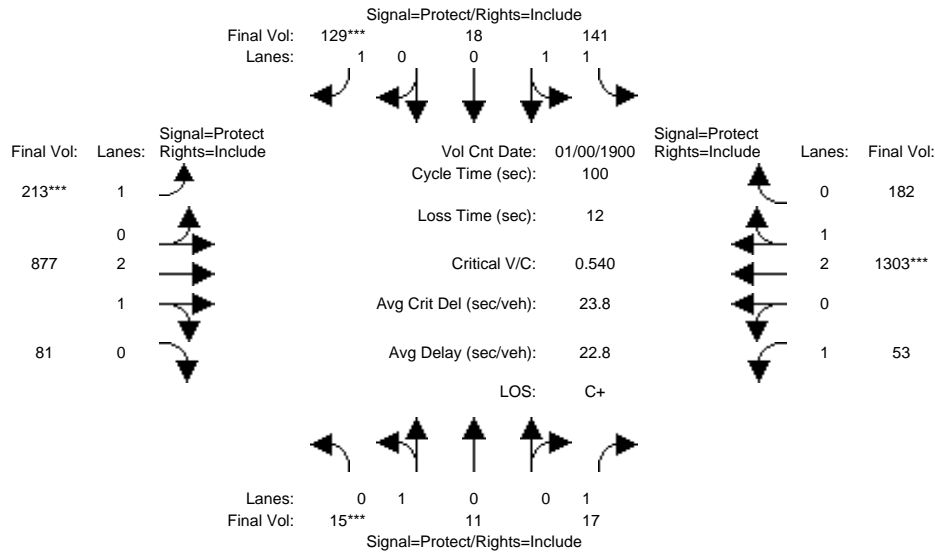

Approach:	North Bound			South Bound			East Bound			West Bound		
	L	T	R	L	T	R	L	T	R	L	T	R
Min. Green:	7	10	10	7	10	10	7	10	10	7	10	10
Y+R:	4.0	4.0	4.0	4.0	4.0	4.0	4.0	4.0	4.0	4.0	4.0	4.0
Volume Module: >> Count Date: 0 Jan 1900 << 12:00:00 AM												
Base Vol:	15	11	17	140	18	129	213	832	81	53	1231	182
Growth Adj:	1.00	1.00	1.00	1.00	1.00	1.00	1.00	1.00	1.00	1.00	1.00	1.00
Initial Bse:	15	11	17	140	18	129	213	832	81	53	1231	182
Added Vol:	0	0	0	1	0	0	0	45	0	0	72	0
PasserByVol:	0	0	0	0	0	0	0	0	0	0	0	0
Initial Fut:	15	11	17	141	18	129	213	877	81	53	1303	182
User Adj:	1.00	1.00	1.00	1.00	1.00	1.00	1.00	1.00	1.00	1.00	1.00	1.00
PHF Adj:	1.00	1.00	1.00	1.00	1.00	1.00	1.00	1.00	1.00	1.00	1.00	1.00
PHF Volume:	15	11	17	141	18	129	213	877	81	53	1303	182
Reduct Vol:	0	0	0	0	0	0	0	0	0	0	0	0
Reduced Vol:	15	11	17	141	18	129	213	877	81	53	1303	182
PCE Adj:	1.00	1.00	1.00	1.00	1.00	1.00	1.00	1.00	1.00	1.00	1.00	1.00
MLF Adj:	1.00	1.00	1.00	1.00	1.00	1.00	1.00	1.00	1.00	1.00	1.00	1.00
Final Volume:	15	11	17	141	18	129	213	877	81	53	1303	182
Saturation Flow Module:												
Sat/Lane:	1900	1900	1900	1900	1900	1900	1900	1900	1900	1900	1900	1900
Adjustment:	0.95	0.95	0.92	0.93	0.95	0.92	0.92	0.99	0.95	0.92	0.99	0.95
Lanes:	0.58	0.42	1.00	1.78	0.22	1.00	1.00	2.74	0.26	1.00	2.62	0.38
Final Sat.:	1038	762	1750	3148	402	1750	1750	5126	473	1750	4913	686
Capacity Analysis Module:												
Vol/Sat:	0.01	0.01	0.01	0.04	0.04	0.07	0.12	0.17	0.17	0.03	0.27	0.27
Crit Moves:	****					****	****				****	
Green Time:	7.0	11.7	11.7	8.2	13.0	13.0	21.4	48.3	48.3	19.8	46.6	46.6
Volume/Cap:	0.21	0.12	0.08	0.54	0.35	0.57	0.57	0.35	0.35	0.15	0.57	0.57
Delay/Veh:	44.7	39.8	39.5	46.2	40.1	44.3	37.2	16.2	16.2	33.4	19.7	19.7
User DelAdj:	1.00	1.00	1.00	1.00	1.00	1.00	1.00	1.00	1.00	1.00	1.00	1.00
AdjDel/Veh:	44.7	39.8	39.5	46.2	40.1	44.3	37.2	16.2	16.2	33.4	19.7	19.7
LOS by Move:	D	D	D	D	D	D	D+	B	B	C-	B-	B-
HCM2kAvgQ:	1	1	1	3	2	4	7	6	6	2	11	11

Note: Queue reported is the number of cars per lane.

San Antonio Village Phase III MTA
 SJ21-2068
 Background AM

Level Of Service Computation Report
 2000 HCM Operations (Future Volume Alternative)
 Background AM

Intersection #5: El Camino Real and Ortega Avenue

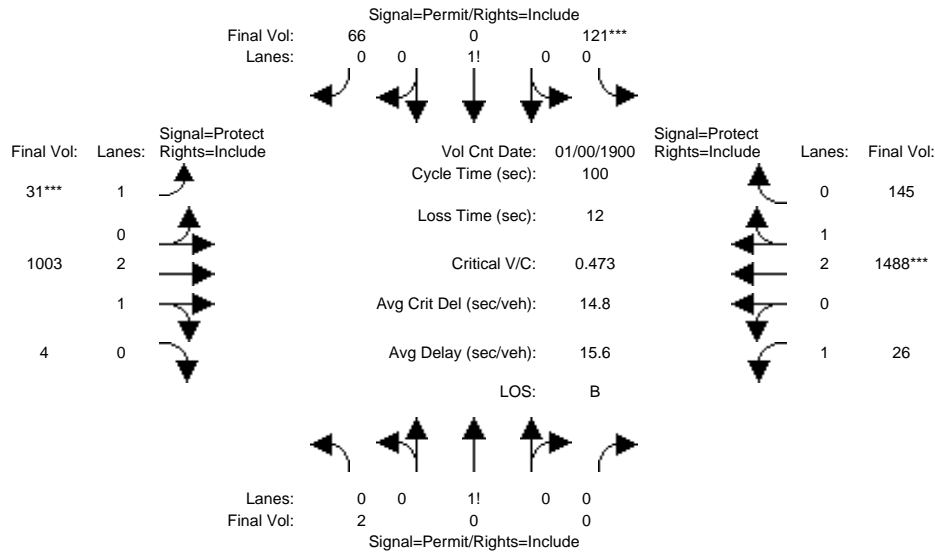

Approach:	North Bound			South Bound			East Bound			West Bound		
	L	T	R	L	T	R	L	T	R	L	T	R
Min. Green:	10	10	10	10	10	10	7	10	10	7	10	10
Y+R:	4.0	4.0	4.0	4.0	4.0	4.0	4.0	4.0	4.0	4.0	4.0	4.0
Volume Module: >> Count Date: 0 Jan 1900 << 12:00:00 AM												
Base Vol:	2	0	0	121	0	66	31	951	4	26	1441	145
Growth Adj:	1.00	1.00	1.00	1.00	1.00	1.00	1.00	1.00	1.00	1.00	1.00	1.00
Initial Bse:	2	0	0	121	0	66	31	951	4	26	1441	145
Added Vol:	0	0	0	0	0	0	0	52	0	0	47	0
PasserByVol:	0	0	0	0	0	0	0	0	0	0	0	0
Initial Fut:	2	0	0	121	0	66	31	1003	4	26	1488	145
User Adj:	1.00	1.00	1.00	1.00	1.00	1.00	1.00	1.00	1.00	1.00	1.00	1.00
PHF Adj:	1.00	1.00	1.00	1.00	1.00	1.00	1.00	1.00	1.00	1.00	1.00	1.00
PHF Volume:	2	0	0	121	0	66	31	1003	4	26	1488	145
Reduct Vol:	0	0	0	0	0	0	0	0	0	0	0	0
Reduced Vol:	2	0	0	121	0	66	31	1003	4	26	1488	145
PCE Adj:	1.00	1.00	1.00	1.00	1.00	1.00	1.00	1.00	1.00	1.00	1.00	1.00
MLF Adj:	1.00	1.00	1.00	1.00	1.00	1.00	1.00	1.00	1.00	1.00	1.00	1.00
Final Volume:	2	0	0	121	0	66	31	1003	4	26	1488	145
Saturation Flow Module:												
Sat/Lane:	1900	1900	1900	1900	1900	1900	1900	1900	1900	1900	1900	1900
Adjustment:	0.92	1.00	0.92	0.92	0.92	0.92	0.92	0.98	0.95	0.92	0.99	0.95
Lanes:	1.00	0.00	0.00	0.65	0.00	0.35	1.00	2.99	0.01	1.00	2.72	0.28
Final Sat.:	1750	0	0	1132	0	618	1750	5578	22	1750	5102	497
Capacity Analysis Module:												
Vol/Sat:	0.00	0.00	0.00	0.11	0.00	0.11	0.02	0.18	0.18	0.01	0.29	0.29
Crit Moves:				****				****				****
Green Time:	21.7	0.0	0.0	21.7	0.0	21.7	7.0	47.7	47.7	18.6	59.3	59.3
Volume/Cap:	0.01	0.00	0.00	0.49	0.00	0.49	0.25	0.38	0.38	0.08	0.49	0.49
Uniform Del:	30.7	0.0	0.0	34.3	0.0	34.3	44.0	16.7	16.7	33.7	11.7	11.7
IncrcmntDel:	0.0	0.0	0.0	1.0	0.0	1.0	1.1	0.1	0.1	0.1	0.1	0.1
InitQueuDel:	0.0	0.0	0.0	0.0	0.0	0.0	0.0	0.0	0.0	0.0	0.0	0.0
Delay Adj:	1.00	0.00	0.00	1.00	0.00	1.00	1.00	1.00	1.00	1.00	1.00	1.00
Delay/Veh:	30.7	0.0	0.0	35.3	0.0	35.3	45.1	16.8	16.8	33.8	11.8	11.8
User DelAdj:	1.00	1.00	1.00	1.00	1.00	1.00	1.00	1.00	1.00	1.00	1.00	1.00
AdjDel/Veh:	30.7	0.0	0.0	35.3	0.0	35.3	45.1	16.8	16.8	33.8	11.8	11.8
LOS by Move:	C	A	A	D+	A	D+	D	B	B	C-	B+	B+
HCM2kAvgQ:	0	0	0	6	0	6	1	7	7	1	10	10

Note: Queue reported is the number of cars per lane.

San Antonio Village Phase III MTA
 SJ21-2068
 Background AM

Level Of Service Computation Report
 2000 HCM Operations (Future Volume Alternative)
 Background PP AM

Intersection #5: El Camino Real and Ortega Avenue

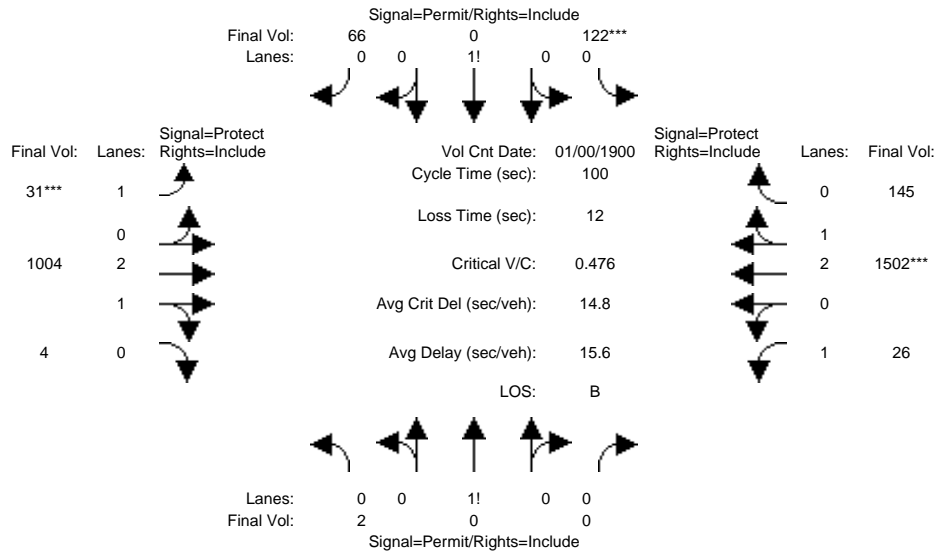

Approach:	North Bound			South Bound			East Bound			West Bound		
	L	T	R	L	T	R	L	T	R	L	T	R
Min. Green:	10	10	10	10	10	10	7	10	10	7	10	10
Y+R:	4.0	4.0	4.0	4.0	4.0	4.0	4.0	4.0	4.0	4.0	4.0	4.0
Volume Module: >> Count Date: 0 Jan 1900 << 12:00:00 AM												
Base Vol:	2	0	0	121	0	66	31	951	4	26	1441	145
Growth Adj:	1.00	1.00	1.00	1.00	1.00	1.00	1.00	1.00	1.00	1.00	1.00	1.00
Initial Bse:	2	0	0	121	0	66	31	951	4	26	1441	145
Added Vol:	0	0	0	1	0	0	0	53	0	0	61	0
PasserByVol:	0	0	0	0	0	0	0	0	0	0	0	0
Initial Fut:	2	0	0	122	0	66	31	1004	4	26	1502	145
User Adj:	1.00	1.00	1.00	1.00	1.00	1.00	1.00	1.00	1.00	1.00	1.00	1.00
PHF Adj:	1.00	1.00	1.00	1.00	1.00	1.00	1.00	1.00	1.00	1.00	1.00	1.00
PHF Volume:	2	0	0	122	0	66	31	1004	4	26	1502	145
Reduct Vol:	0	0	0	0	0	0	0	0	0	0	0	0
Reduced Vol:	2	0	0	122	0	66	31	1004	4	26	1502	145
PCE Adj:	1.00	1.00	1.00	1.00	1.00	1.00	1.00	1.00	1.00	1.00	1.00	1.00
MLF Adj:	1.00	1.00	1.00	1.00	1.00	1.00	1.00	1.00	1.00	1.00	1.00	1.00
Final Volume:	2	0	0	122	0	66	31	1004	4	26	1502	145
Saturation Flow Module:												
Sat/Lane:	1900	1900	1900	1900	1900	1900	1900	1900	1900	1900	1900	1900
Adjustment:	0.92	1.00	0.92	0.92	0.92	0.92	0.92	0.98	0.95	0.92	0.99	0.95
Lanes:	1.00	0.00	0.00	0.65	0.00	0.35	1.00	2.99	0.01	1.00	2.73	0.27
Final Sat.:	1750	0	0	1136	0	614	1750	5578	22	1750	5106	493
Capacity Analysis Module:												
Vol/Sat:	0.00	0.00	0.00	0.11	0.00	0.11	0.02	0.18	0.18	0.01	0.29	0.29
Crit Moves:				****				****				****
Green Time:	21.7	0.0	0.0	21.7	0.0	21.7	7.0	47.8	47.8	18.6	59.3	59.3
Volume/Cap:	0.01	0.00	0.00	0.50	0.00	0.50	0.25	0.38	0.38	0.08	0.50	0.50
Delay/Veh:	30.7	0.0	0.0	35.4	0.0	35.4	45.1	16.7	16.7	33.8	11.8	11.8
User DelAdj:	1.00	1.00	1.00	1.00	1.00	1.00	1.00	1.00	1.00	1.00	1.00	1.00
AdjDel/Veh:	30.7	0.0	0.0	35.4	0.0	35.4	45.1	16.7	16.7	33.8	11.8	11.8
LOS by Move:	C	A	A	D+	A	D+	D	B	B	C-	B+	B+
HCM2kAvgQ:	0	0	0	6	0	6	1	7	7	1	10	10

Note: Queue reported is the number of cars per lane.

San Antonio Village Phase III MTA
 SJ21-2068
 Background AM

Level Of Service Computation Report
 2000 HCM Operations (Future Volume Alternative)
 Background AM

Intersection #6: El Camino Real and Rengstorff Avenue

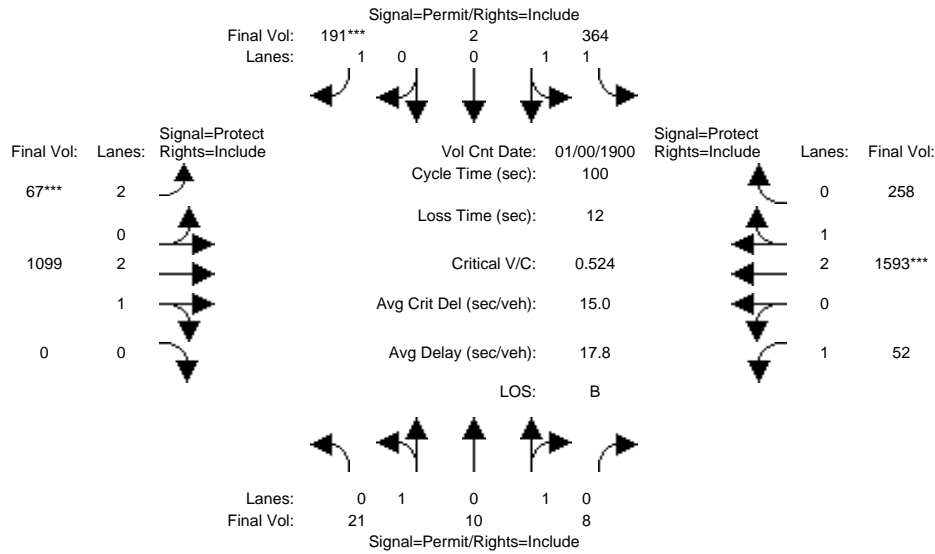

Approach:	North Bound			South Bound			East Bound			West Bound		
	L	T	R	L	T	R	L	T	R	L	T	R
Min. Green:	10	10	10	7	10	10	7	10	10	7	10	10
Y+R:	4.0	4.0	4.0	4.0	4.0	4.0	4.0	4.0	4.0	4.0	4.0	4.0
Volume Module: >> Count Date: 0 Jan 1900 << 12:00:00 AM												
Base Vol:	0	0	0	359	2	182	55	1064	0	52	1575	256
Growth Adj:	1.00	1.00	1.00	1.00	1.00	1.00	1.00	1.00	1.00	1.00	1.00	1.00
Initial Bse:	0	0	0	359	2	182	55	1064	0	52	1575	256
Added Vol:	21	10	8	5	0	9	12	35	0	0	18	2
PasserByVol:	0	0	0	0	0	0	0	0	0	0	0	0
Initial Fut:	21	10	8	364	2	191	67	1099	0	52	1593	258
User Adj:	1.00	1.00	1.00	1.00	1.00	1.00	1.00	1.00	1.00	1.00	1.00	1.00
PHF Adj:	1.00	1.00	1.00	1.00	1.00	1.00	1.00	1.00	1.00	1.00	1.00	1.00
PHF Volume:	21	10	8	364	2	191	67	1099	0	52	1593	258
Reduct Vol:	0	0	0	0	0	0	0	0	0	0	0	0
Reduced Vol:	21	10	8	364	2	191	67	1099	0	52	1593	258
PCE Adj:	1.00	1.00	1.00	1.00	1.00	1.00	1.00	1.00	1.00	1.00	1.00	1.00
MLF Adj:	1.00	1.00	1.00	1.00	1.00	1.00	1.00	1.00	1.00	1.00	1.00	1.00
FinalVolume:	21	10	8	364	2	191	67	1099	0	52	1593	258
Saturation Flow Module:												
Sat/Lane:	1900	1900	1900	1900	1900	1900	1900	1900	1900	1900	1900	1900
Adjustment:	0.95	0.95	0.95	0.93	0.95	0.92	0.83	0.98	0.92	0.92	0.99	0.95
Lanes:	1.00	0.56	0.44	1.99	0.01	1.00	2.00	3.00	0.00	1.00	2.57	0.43
Final Sat.:	1800	1000	800	3531	19	1750	3150	5600	0	1750	4818	780
Capacity Analysis Module:												
Vol/Sat:	0.01	0.01	0.01	0.10	0.10	0.11	0.02	0.20	0.00	0.03	0.33	0.33
Crit Moves:						****	****				****	
Green Time:	20.1	20.1	20.1	20.1	20.1	20.1	7.0	50.0	0.0	17.9	60.9	60.9
Volume/Cap:	0.06	0.05	0.05	0.51	0.51	0.54	0.30	0.39	0.00	0.17	0.54	0.54
Uniform Del:	32.3	32.2	32.2	35.6	35.6	35.8	44.2	15.5	0.0	34.8	11.4	11.4
IncrcmntDel:	0.0	0.0	0.0	0.6	0.6	1.7	0.8	0.1	0.0	0.3	0.2	0.2
InitQueuDel:	0.0	0.0	0.0	0.0	0.0	0.0	0.0	0.0	0.0	0.0	0.0	0.0
Delay Adj:	1.00	1.00	1.00	1.00	1.00	1.00	1.00	1.00	0.00	1.00	1.00	1.00
Delay/Veh:	32.3	32.3	32.3	36.2	36.2	37.6	45.0	15.6	0.0	35.0	11.6	11.6
User DelAdj:	1.00	1.00	1.00	1.00	1.00	1.00	1.00	1.00	1.00	1.00	1.00	1.00
AdjDel/Veh:	32.3	32.3	32.3	36.2	36.2	37.6	45.0	15.6	0.0	35.0	11.6	11.6
LOS by Move:	C-	C-	C-	D+	D+	D+	D	B	A	D+	B+	B+
HCM2kAvgQ:	1	0	0	5	5	6	1	7	0	2	11	11

Note: Queue reported is the number of cars per lane.

San Antonio Village Phase III MTA
 SJ21-2068
 Background AM

Level Of Service Computation Report
 2000 HCM Operations (Future Volume Alternative)
 Background PP AM

Intersection #6: El Camino Real and Rengstorff Avenue

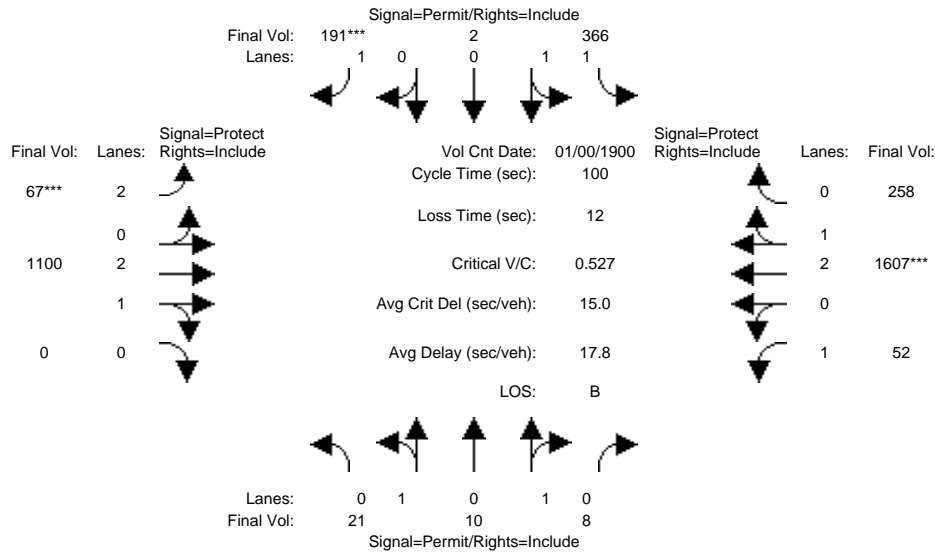

Approach:	North Bound			South Bound			East Bound			West Bound		
	L	T	R	L	T	R	L	T	R	L	T	R
Min. Green:	10	10	10	7	10	10	7	10	10	7	10	10
Y+R:	4.0	4.0	4.0	4.0	4.0	4.0	4.0	4.0	4.0	4.0	4.0	4.0
Volume Module: >> Count Date: 0 Jan 1900 << 12:00:00 AM												
Base Vol:	0	0	0	359	2	182	55	1064	0	52	1575	256
Growth Adj:	1.00	1.00	1.00	1.00	1.00	1.00	1.00	1.00	1.00	1.00	1.00	1.00
Initial Bse:	0	0	0	359	2	182	55	1064	0	52	1575	256
Added Vol:	21	10	8	7	0	9	12	36	0	0	32	2
PasserByVol:	0	0	0	0	0	0	0	0	0	0	0	0
Initial Fut:	21	10	8	366	2	191	67	1100	0	52	1607	258
User Adj:	1.00	1.00	1.00	1.00	1.00	1.00	1.00	1.00	1.00	1.00	1.00	1.00
PHF Adj:	1.00	1.00	1.00	1.00	1.00	1.00	1.00	1.00	1.00	1.00	1.00	1.00
PHF Volume:	21	10	8	366	2	191	67	1100	0	52	1607	258
Reduct Vol:	0	0	0	0	0	0	0	0	0	0	0	0
Reduced Vol:	21	10	8	366	2	191	67	1100	0	52	1607	258
PCE Adj:	1.00	1.00	1.00	1.00	1.00	1.00	1.00	1.00	1.00	1.00	1.00	1.00
MLF Adj:	1.00	1.00	1.00	1.00	1.00	1.00	1.00	1.00	1.00	1.00	1.00	1.00
FinalVolume:	21	10	8	366	2	191	67	1100	0	52	1607	258
Saturation Flow Module:												
Sat/Lane:	1900	1900	1900	1900	1900	1900	1900	1900	1900	1900	1900	1900
Adjustment:	0.95	0.95	0.95	0.93	0.95	0.92	0.83	0.98	0.92	0.92	0.99	0.95
Lanes:	1.00	0.56	0.44	1.99	0.01	1.00	2.00	3.00	0.00	1.00	2.57	0.43
Final Sat.:	1800	1000	800	3531	19	1750	3150	5600	0	1750	4824	775
Capacity Analysis Module:												
Vol/Sat:	0.01	0.01	0.01	0.10	0.10	0.11	0.02	0.20	0.00	0.03	0.33	0.33
Crit Moves:						****	****				****	
Green Time:	20.0	20.0	20.0	20.0	20.0	20.0	7.0	50.1	0.0	17.9	61.0	61.0
Volume/Cap:	0.06	0.05	0.05	0.52	0.52	0.55	0.30	0.39	0.00	0.17	0.55	0.55
Delay/Veh:	32.4	32.4	32.4	36.4	36.4	37.7	45.0	15.6	0.0	35.0	11.6	11.6
User DelAdj:	1.00	1.00	1.00	1.00	1.00	1.00	1.00	1.00	1.00	1.00	1.00	1.00
AdjDel/Veh:	32.4	32.4	32.4	36.4	36.4	37.7	45.0	15.6	0.0	35.0	11.6	11.6
LOS by Move:	C-	C-	C-	D+	D+	D+	D	B	A	D+	B+	B+
HCM2kAvgQ:	1	0	0	5	5	6	1	7	0	2	11	11

Note: Queue reported is the number of cars per lane.

San Antonio Village Phase III MTA
 SJ21-2068
 Background AM

Level Of Service Computation Report
 2000 HCM Operations (Future Volume Alternative)
 Background AM

Intersection #7: Fayette Drive and San Antonio Road

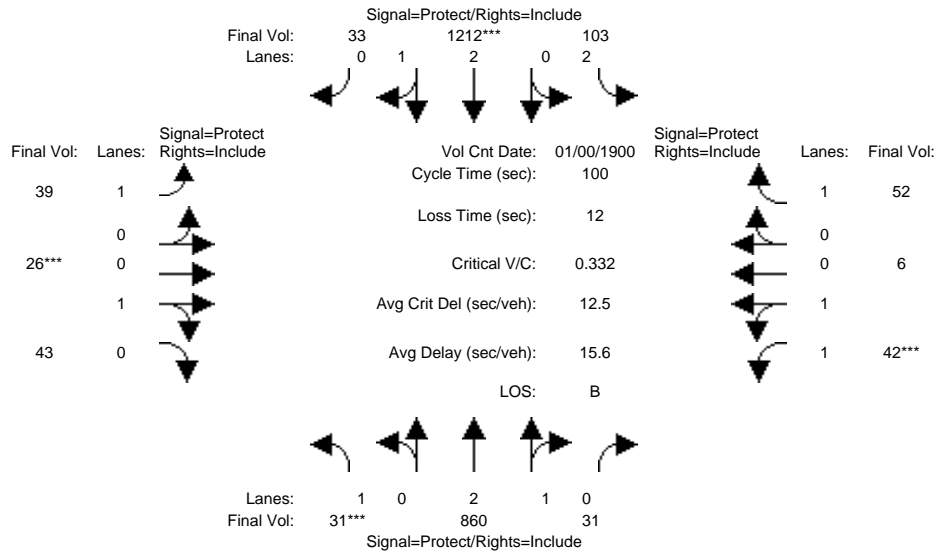

Approach:	North Bound			South Bound			East Bound			West Bound		
Movement:	L	T	R	L	T	R	L	T	R	L	T	R
Min. Green:	7	10	10	7	10	10	7	10	10	7	10	10
Y+R:	4.0	4.0	4.0	4.0	4.0	4.0	4.0	4.0	4.0	4.0	4.0	4.0
Volume Module: >> Count Date: 0 Jan 1900 << 12:00:00 AM												
Base Vol:	29	817	31	103	1135	31	33	26	37	42	6	52
Growth Adj:	1.00	1.00	1.00	1.00	1.00	1.00	1.00	1.00	1.00	1.00	1.00	1.00
Initial Bse:	29	817	31	103	1135	31	33	26	37	42	6	52
Added Vol:	2	43	0	0	77	2	6	0	6	0	0	0
PasserByVol:	0	0	0	0	0	0	0	0	0	0	0	0
Initial Fut:	31	860	31	103	1212	33	39	26	43	42	6	52
User Adj:	1.00	1.00	1.00	1.00	1.00	1.00	1.00	1.00	1.00	1.00	1.00	1.00
PHF Adj:	1.00	1.00	1.00	1.00	1.00	1.00	1.00	1.00	1.00	1.00	1.00	1.00
PHF Volume:	31	860	31	103	1212	33	39	26	43	42	6	52
Reduct Vol:	0	0	0	0	0	0	0	0	0	0	0	0
Reduced Vol:	31	860	31	103	1212	33	39	26	43	42	6	52
PCE Adj:	1.00	1.00	1.00	1.00	1.00	1.00	1.00	1.00	1.00	1.00	1.00	1.00
MLF Adj:	1.00	1.00	1.00	1.00	1.00	1.00	1.00	1.00	1.00	1.00	1.00	1.00
FinalVolume:	31	860	31	103	1212	33	39	26	43	42	6	52
Saturation Flow Module:												
Sat/Lane:	1900	1900	1900	1900	1900	1900	1900	1900	1900	1900	1900	1900
Adjustment:	0.92	0.98	0.95	0.83	0.98	0.95	0.92	0.95	0.95	0.93	0.95	0.92
Lanes:	1.00	2.89	0.11	2.00	2.92	0.08	1.00	0.38	0.62	1.75	0.25	1.00
Final Sat.:	1750	5405	195	3150	5451	148	1750	678	1122	3106	444	1750
Capacity Analysis Module:												
Vol/Sat:	0.02	0.16	0.16	0.03	0.22	0.22	0.02	0.04	0.04	0.01	0.01	0.03
Crit Moves:	****			****			****			****		
Green Time:	7.0	48.7	48.7	21.4	63.1	63.1	7.4	10.9	10.9	7.0	10.5	10.5
Volume/Cap:	0.25	0.33	0.33	0.15	0.35	0.35	0.30	0.35	0.35	0.19	0.13	0.28
Uniform Del:	44.0	15.7	15.7	31.9	8.7	8.7	43.9	41.3	41.3	43.8	40.6	41.3
IncrcmntDel:	1.1	0.1	0.1	0.1	0.1	0.1	1.3	1.1	1.1	0.4	0.2	0.8
InitQueuDel:	0.0	0.0	0.0	0.0	0.0	0.0	0.0	0.0	0.0	0.0	0.0	0.0
Delay Adj:	1.00	1.00	1.00	1.00	1.00	1.00	1.00	1.00	1.00	1.00	1.00	1.00
Delay/Veh:	45.1	15.7	15.7	32.0	8.8	8.8	45.2	42.4	42.4	44.2	40.7	42.1
User DelAdj:	1.00	1.00	1.00	1.00	1.00	1.00	1.00	1.00	1.00	1.00	1.00	1.00
AdjDel/Veh:	45.1	15.7	15.7	32.0	8.8	8.8	45.2	42.4	42.4	44.2	40.7	42.1
LOS by Move:	D	B	B	C-	A	A	D	D	D	D	D	D
HCM2kAvgQ:	1	5	5	1	6	6	2	2	2	1	1	2

Note: Queue reported is the number of cars per lane.

San Antonio Village Phase III MTA
 SJ21-2068
 Background AM

Level Of Service Computation Report
 2000 HCM Operations (Future Volume Alternative)
 Background PP AM

Intersection #7: Fayette Drive and San Antonio Road

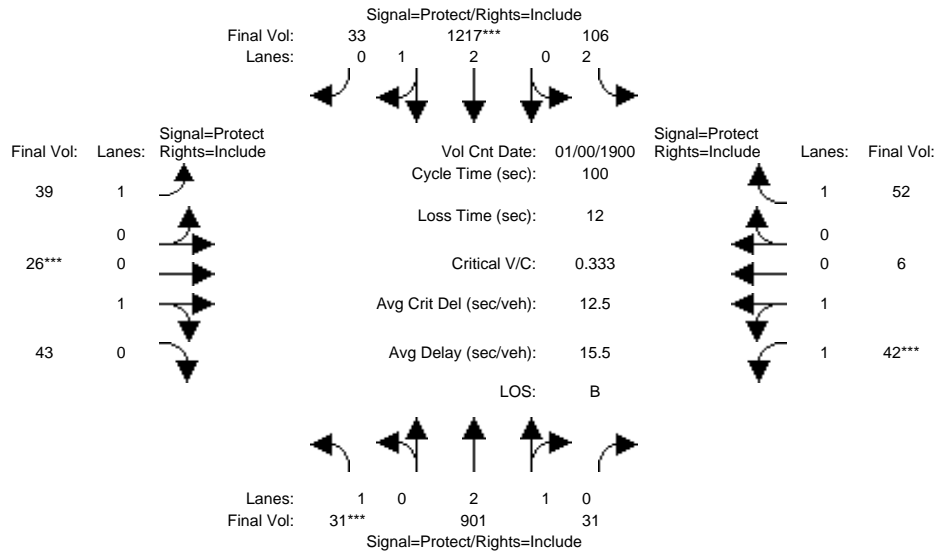

Approach:	North Bound			South Bound			East Bound			West Bound		
	L	T	R	L	T	R	L	T	R	L	T	R
Min. Green:	7	10	10	7	10	10	7	10	10	7	10	10
Y+R:	4.0	4.0	4.0	4.0	4.0	4.0	4.0	4.0	4.0	4.0	4.0	4.0

Volume Module:	>> Count Date: 0 Jan 1900 << 12:00:00 AM											
Base Vol:	29	817	31	103	1135	31	33	26	37	42	6	52
Growth Adj:	1.00	1.00	1.00	1.00	1.00	1.00	1.00	1.00	1.00	1.00	1.00	1.00
Initial Bse:	29	817	31	103	1135	31	33	26	37	42	6	52
Added Vol:	2	84	0	3	82	2	6	0	6	0	0	0
PasserByVol:	0	0	0	0	0	0	0	0	0	0	0	0
Initial Fut:	31	901	31	106	1217	33	39	26	43	42	6	52
User Adj:	1.00	1.00	1.00	1.00	1.00	1.00	1.00	1.00	1.00	1.00	1.00	1.00
PHF Adj:	1.00	1.00	1.00	1.00	1.00	1.00	1.00	1.00	1.00	1.00	1.00	1.00
PHF Volume:	31	901	31	106	1217	33	39	26	43	42	6	52
Reduct Vol:	0	0	0	0	0	0	0	0	0	0	0	0
Reduced Vol:	31	901	31	106	1217	33	39	26	43	42	6	52
PCE Adj:	1.00	1.00	1.00	1.00	1.00	1.00	1.00	1.00	1.00	1.00	1.00	1.00
MLF Adj:	1.00	1.00	1.00	1.00	1.00	1.00	1.00	1.00	1.00	1.00	1.00	1.00
FinalVolume:	31	901	31	106	1217	33	39	26	43	42	6	52

Saturation Flow Module:												
Sat/Lane:	1900	1900	1900	1900	1900	1900	1900	1900	1900	1900	1900	1900
Adjustment:	0.92	0.98	0.95	0.83	0.98	0.95	0.92	0.95	0.95	0.93	0.95	0.92
Lanes:	1.00	2.90	0.10	2.00	2.92	0.08	1.00	0.38	0.62	1.75	0.25	1.00
Final Sat.:	1750	5413	186	3150	5452	148	1750	678	1122	3106	444	1750

Capacity Analysis Module:												
Vol/Sat:	0.02	0.17	0.17	0.03	0.22	0.22	0.02	0.04	0.04	0.01	0.01	0.03
Crit Moves:	****			****			****			****		
Green Time:	7.0	49.4	49.4	20.8	63.2	63.2	7.3	10.8	10.8	7.0	10.5	10.5
Volume/Cap:	0.25	0.34	0.34	0.16	0.35	0.35	0.30	0.35	0.35	0.19	0.13	0.28
Delay/Veh:	45.1	15.4	15.4	32.6	8.8	8.8	45.2	42.4	42.4	44.2	40.8	42.1
User DelAdj:	1.00	1.00	1.00	1.00	1.00	1.00	1.00	1.00	1.00	1.00	1.00	1.00
AdjDel/Veh:	45.1	15.4	15.4	32.6	8.8	8.8	45.2	42.4	42.4	44.2	40.8	42.1
LOS by Move:	D	B	B	C-	A	A	D	D	D	D	D	D
HCM2kAvgQ:	1	6	6	2	6	6	2	2	2	1	1	2

Note: Queue reported is the number of cars per lane.

San Antonio Village Phase III MTA
SJ21-2068
Background AM

Level Of Service Computation Report
2000 HCM Unsignalized (Future Volume Alternative)
Background AM

Intersection #8: Miller Avenue and San Antonio Road

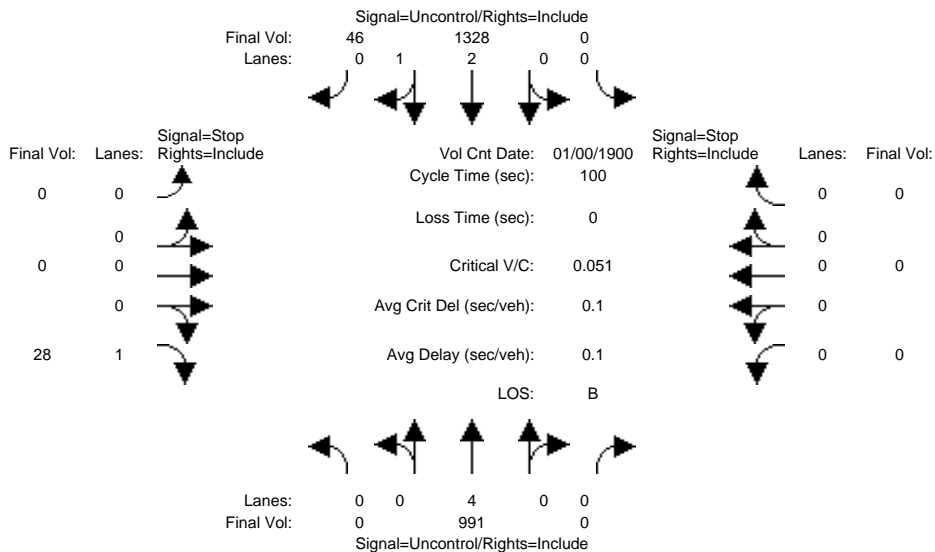

Approach:	North Bound			South Bound			East Bound			West Bound		
	L	T	R	L	T	R	L	T	R	L	T	R
Volume Module: >> Count Date: 0 Jan 1900 << 12:00:00 AM												
Base Vol:	0	942	0	0	1249	46	0	0	28	0	0	0
Growth Adj:	1.00	1.00	1.00	1.00	1.00	1.00	1.00	1.00	1.00	1.00	1.00	1.00
Initial Bse:	0	942	0	0	1249	46	0	0	28	0	0	0
Added Vol:	0	49	0	0	79	0	0	0	0	0	0	0
PasserByVol:	0	0	0	0	0	0	0	0	0	0	0	0
Initial Fut:	0	991	0	0	1328	46	0	0	28	0	0	0
User Adj:	1.00	1.00	1.00	1.00	1.00	1.00	1.00	1.00	1.00	1.00	1.00	1.00
PHF Adj:	1.00	1.00	1.00	1.00	1.00	1.00	1.00	1.00	1.00	1.00	1.00	1.00
PHF Volume:	0	991	0	0	1328	46	0	0	28	0	0	0
Reduct Vol:	0	0	0	0	0	0	0	0	0	0	0	0
FinalVolume:	0	991	0	0	1328	46	0	0	28	0	0	0
Critical Gap Module:												
Critical Gp:	xxxxx	xxxx	xxxxx	xxxxx	xxxx	xxxxx	xxxxx	xxxx	6.9	xxxxx	xxxx	xxxxx
FollowUpTim:	xxxxxx	xxxx	xxxxxx	xxxxxx	xxxx	xxxxxx	xxxxxx	xxxx	3.3	xxxxxx	xxxx	xxxxxx
Capacity Module:												
Cnflct Vol:	xxxx	xxxx	xxxxxx	xxxx	xxxx	xxxxxx	xxxx	xxxx	466	xxxx	xxxx	xxxxxx
Potent Cap.:	xxxx	xxxx	xxxxxx	xxxx	xxxx	xxxxxx	xxxx	xxxx	549	xxxx	xxxx	xxxxxx
Move Cap.:	xxxx	xxxx	xxxxxx	xxxx	xxxx	xxxxxx	xxxx	xxxx	549	xxxx	xxxx	xxxxxx
Volume/Cap:	xxxx	xxxx	xxxx	xxxx	xxxx	xxxx	xxxx	xxxx	0.05	xxxx	xxxx	xxxx
Level Of Service Module:												
2Way95thQ:	xxxx	xxxx	xxxxxx	xxxx	xxxx	xxxxxx	xxxx	xxxx	0.2	xxxx	xxxx	xxxxxx
Control Del:	xxxxxx	xxxx	xxxxxx	xxxxxx	xxxx	xxxxxx	xxxxxx	xxxx	11.9	xxxxxx	xxxx	xxxxxx
LOS by Move:	*	*	*	*	*	*	*	*	B	*	*	*
Movement:	LT	LTR	RT	LT	LTR	RT	LT	LTR	RT	LT	LTR	RT
Shared Cap.:	xxxx	xxxx	xxxxxx	xxxx	xxxx	xxxxxx	xxxx	xxxx	xxxxxx	xxxx	xxxx	xxxxxx
SharedQueue:	xxxxxx	xxxx	xxxxxx	xxxxxx	xxxx	xxxxxx	xxxxxx	xxxx	xxxxxx	xxxxxx	xxxx	xxxxxx
Shrd ConDel:	xxxxxx	xxxx	xxxxxx	xxxxxx	xxxx	xxxxxx	xxxxxx	xxxx	xxxxxx	xxxxxx	xxxx	xxxxxx
Shared LOS:	*	*	*	*	*	*	*	*	*	*	*	*
ApproachDel:	xxxxxxx			xxxxxxx					11.9	xxxxxxx		
ApproachLOS:	*			*					B	*		

Note: Queue reported is the number of cars per lane.

San Antonio Village Phase III MTA
SJ21-2068
Background AM

Level Of Service Computation Report
2000 HCM Unsignalized (Future Volume Alternative)
Background PP AM

Intersection #8: Miller Avenue and San Antonio Road

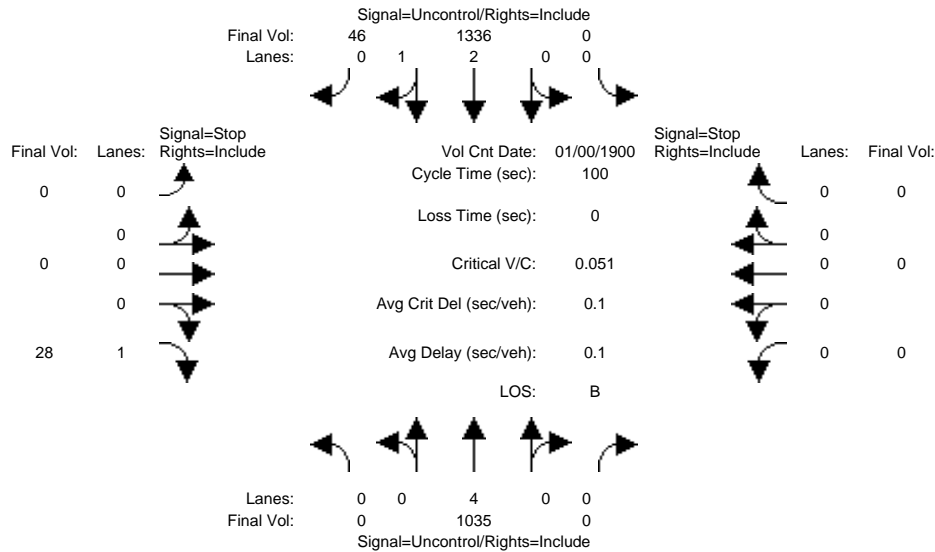

Approach:	North Bound			South Bound			East Bound			West Bound		
	L	T	R	L	T	R	L	T	R	L	T	R
Volume Module: >> Count Date: 0 Jan 1900 << 12:00:00 AM												
Base Vol:	0	942	0	0	1249	46	0	0	28	0	0	0
Growth Adj:	1.00	1.00	1.00	1.00	1.00	1.00	1.00	1.00	1.00	1.00	1.00	1.00
Initial Bse:	0	942	0	0	1249	46	0	0	28	0	0	0
Added Vol:	0	93	0	0	87	0	0	0	0	0	0	0
PasserByVol:	0	0	0	0	0	0	0	0	0	0	0	0
Initial Fut:	0	1035	0	0	1336	46	0	0	28	0	0	0
User Adj:	1.00	1.00	1.00	1.00	1.00	1.00	1.00	1.00	1.00	1.00	1.00	1.00
PHF Adj:	1.00	1.00	1.00	1.00	1.00	1.00	1.00	1.00	1.00	1.00	1.00	1.00
PHF Volume:	0	1035	0	0	1336	46	0	0	28	0	0	0
Reduct Vol:	0	0	0	0	0	0	0	0	0	0	0	0
FinalVolume:	0	1035	0	0	1336	46	0	0	28	0	0	0
Critical Gap Module:												
Critical Gp:	xxxxx	xxxx	xxxxx	xxxxx	xxxx	xxxxx	xxxxx	xxxx	6.9	xxxxx	xxxx	xxxxx
FollowUpTim:	xxxxxx	xxxx	xxxxxx	xxxxxx	xxxx	xxxxxx	xxxxxx	xxxx	3.3	xxxxxx	xxxx	xxxxxx
Capacity Module:												
Cnflct Vol:	xxxx	xxxx	xxxxxx	xxxx	xxxx	xxxxxx	xxxx	xxxx	468	xxxx	xxxx	xxxxxx
Potent Cap.:	xxxx	xxxx	xxxxxx	xxxx	xxxx	xxxxxx	xxxx	xxxx	547	xxxx	xxxx	xxxxxx
Move Cap.:	xxxx	xxxx	xxxxxx	xxxx	xxxx	xxxxxx	xxxx	xxxx	547	xxxx	xxxx	xxxxxx
Volume/Cap:	xxxx	xxxx	xxxx	xxxx	xxxx	xxxx	xxxx	xxxx	0.05	xxxx	xxxx	xxxx
Level Of Service Module:												
2Way95thQ:	xxxx	xxxx	xxxxxx	xxxx	xxxx	xxxxxx	xxxx	xxxx	0.2	xxxx	xxxx	xxxxxx
Control Del:	xxxxxx	xxxx	xxxxxx	xxxxxx	xxxx	xxxxxx	xxxxxx	xxxx	11.9	xxxxxx	xxxx	xxxxxx
LOS by Move:	*	*	*	*	*	*	*	*	B	*	*	*
Movement:	LT - LTR - RT	LT - LTR - RT	LT - LTR - RT	LT - LTR - RT	LT - LTR - RT	LT - LTR - RT	LT - LTR - RT	LT - LTR - RT		LT - LTR - RT	LT - LTR - RT	LT - LTR - RT
Shared Cap.:	xxxx	xxxx	xxxxxx	xxxx	xxxx	xxxxxx	xxxx	xxxx	xxxxxx	xxxx	xxxx	xxxxxx
SharedQueue:	xxxxxx	xxxx	xxxxxx	xxxxxx	xxxx	xxxxxx	xxxxxx	xxxx	xxxxxx	xxxxxx	xxxx	xxxxxx
Shrd ConDel:	xxxxxx	xxxx	xxxxxx	xxxxxx	xxxx	xxxxxx	xxxxxx	xxxx	xxxxxx	xxxxxx	xxxx	xxxxxx
Shared LOS:	*	*	*	*	*	*	*	*	*	*	*	*
ApproachDel:	xxxxxxx			xxxxxxx					11.9	xxxxxxx		
ApproachLOS:	*			*					B	*		

Note: Queue reported is the number of cars per lane.

San Antonio Village Phase III MTA
 SJ21-2068
 Background AM

Level Of Service Computation Report
 2000 HCM Operations (Future Volume Alternative)
 Background AM

Intersection #9: Nita Avenue and San Antonio Road

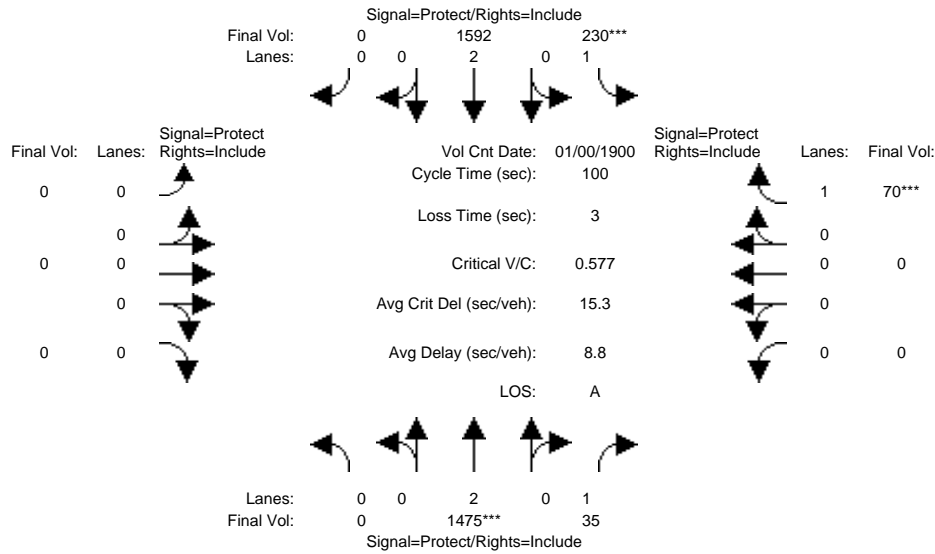

Approach:	North Bound			South Bound			East Bound			West Bound		
	L	T	R	L	T	R	L	T	R	L	T	R
Min. Green:	0	10	10	7	10	0	0	0	0	0	0	10
Y+R:	4.0	4.0	4.0	4.0	4.0	4.0	4.0	4.0	4.0	4.0	4.0	4.0
Volume Module:	>> Count Date: 0 Jan 1900 << 12:00:00 AM											
Base Vol:	0	1413	35	230	1558	0	0	0	0	0	0	70
Growth Adj:	1.00	1.00	1.00	1.00	1.00	1.00	1.00	1.00	1.00	1.00	1.00	1.00
Initial Bse:	0	1413	35	230	1558	0	0	0	0	0	0	70
Added Vol:	0	62	0	0	34	0	0	0	0	0	0	0
PasserByVol:	0	0	0	0	0	0	0	0	0	0	0	0
Initial Fut:	0	1475	35	230	1592	0	0	0	0	0	0	70
User Adj:	1.00	1.00	1.00	1.00	1.00	1.00	1.00	1.00	1.00	1.00	1.00	1.00
PHF Adj:	1.00	1.00	1.00	1.00	1.00	1.00	1.00	1.00	1.00	1.00	1.00	1.00
PHF Volume:	0	1475	35	230	1592	0	0	0	0	0	0	70
Reduct Vol:	0	0	0	0	0	0	0	0	0	0	0	0
Reduced Vol:	0	1475	35	230	1592	0	0	0	0	0	0	70
PCE Adj:	1.00	1.00	1.00	1.00	1.00	1.00	1.00	1.00	1.00	1.00	1.00	1.00
MLF Adj:	1.00	1.00	1.00	1.00	1.00	1.00	1.00	1.00	1.00	1.00	1.00	1.00
FinalVolume:	0	1475	35	230	1592	0	0	0	0	0	0	70
Saturation Flow Module:												
Sat/Lane:	1900	1900	1900	1900	1900	1900	1900	1900	1900	1900	1900	1900
Adjustment:	0.92	1.00	0.92	0.92	1.00	0.92	0.92	1.00	0.92	0.92	1.00	0.92
Lanes:	0.00	2.00	1.00	1.00	2.00	0.00	0.00	0.00	0.00	0.00	0.00	1.00
Final Sat.:	0	3800	1750	1750	3800	0	0	0	0	0	0	1750
Capacity Analysis Module:												
Vol/Sat:	0.00	0.39	0.02	0.13	0.42	0.00	0.00	0.00	0.00	0.00	0.00	0.04
Crit Moves:	****		****									****
Green Time:	0.0	65.0	65.0	22.0	87.0	0.0	0.0	0.0	0.0	0.0	0.0	10.0
Volume/Cap:	0.00	0.60	0.03	0.60	0.48	0.00	0.00	0.00	0.00	0.00	0.00	0.40
Uniform Del:	0.0	10.0	6.3	35.0	1.5	0.0	0.0	0.0	0.0	0.0	0.0	42.2
IncrementDel:	0.0	0.4	0.0	2.6	0.1	0.0	0.0	0.0	0.0	0.0	0.0	1.5
InitQueueDel:	0.0	0.0	0.0	0.0	0.0	0.0	0.0	0.0	0.0	0.0	0.0	0.0
Delay Adj:	0.00	1.00	1.00	1.00	1.00	0.00	0.00	0.00	0.00	0.00	0.00	1.00
Delay/Veh:	0.0	10.4	6.3	37.6	1.6	0.0	0.0	0.0	0.0	0.0	0.0	43.7
User DelAdj:	1.00	1.00	1.00	1.00	1.00	1.00	1.00	1.00	1.00	1.00	1.00	1.00
AdjDel/Veh:	0.0	10.4	6.3	37.6	1.6	0.0	0.0	0.0	0.0	0.0	0.0	43.7
LOS by Move:	A	B+	A	D+	A	A	A	A	A	A	A	D
HCM2kAvgQ:	0	13	0	7	5	0	0	0	0	0	0	3

Note: Queue reported is the number of cars per lane.

San Antonio Village Phase III MTA
 SJ21-2068
 Background AM

Level Of Service Computation Report
 2000 HCM Operations (Future Volume Alternative)
 Background PP AM

Intersection #9: Nita Avenue and San Antonio Road

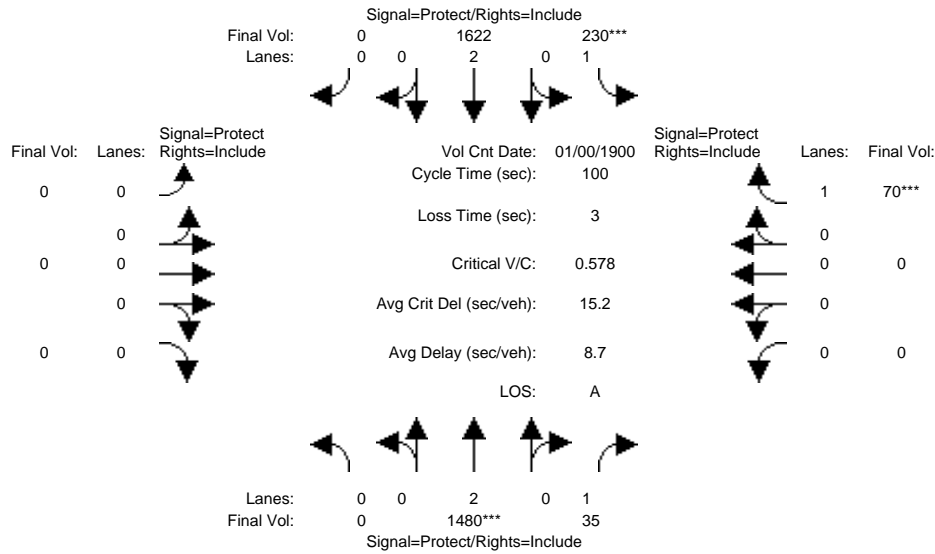

Approach:	North Bound			South Bound			East Bound			West Bound		
	L	T	R	L	T	R	L	T	R	L	T	R
Min. Green:	0	10	10	7	10	0	0	0	0	0	0	10
Y+R:	4.0	4.0	4.0	4.0	4.0	4.0	4.0	4.0	4.0	4.0	4.0	4.0
Volume Module: >> Count Date: 0 Jan 1900 << 12:00:00 AM												
Base Vol:	0	1413	35	230	1558	0	0	0	0	0	0	70
Growth Adj:	1.00	1.00	1.00	1.00	1.00	1.00	1.00	1.00	1.00	1.00	1.00	1.00
Initial Bse:	0	1413	35	230	1558	0	0	0	0	0	0	70
Added Vol:	0	67	0	0	64	0	0	0	0	0	0	0
PasserByVol:	0	0	0	0	0	0	0	0	0	0	0	0
Initial Fut:	0	1480	35	230	1622	0	0	0	0	0	0	70
User Adj:	1.00	1.00	1.00	1.00	1.00	1.00	1.00	1.00	1.00	1.00	1.00	1.00
PHF Adj:	1.00	1.00	1.00	1.00	1.00	1.00	1.00	1.00	1.00	1.00	1.00	1.00
PHF Volume:	0	1480	35	230	1622	0	0	0	0	0	0	70
Reduct Vol:	0	0	0	0	0	0	0	0	0	0	0	0
Reduced Vol:	0	1480	35	230	1622	0	0	0	0	0	0	70
PCE Adj:	1.00	1.00	1.00	1.00	1.00	1.00	1.00	1.00	1.00	1.00	1.00	1.00
MLF Adj:	1.00	1.00	1.00	1.00	1.00	1.00	1.00	1.00	1.00	1.00	1.00	1.00
Final Volume:	0	1480	35	230	1622	0	0	0	0	0	0	70
Saturation Flow Module:												
Sat/Lane:	1900	1900	1900	1900	1900	1900	1900	1900	1900	1900	1900	1900
Adjustment:	0.92	1.00	0.92	0.92	1.00	0.92	0.92	1.00	0.92	0.92	1.00	0.92
Lanes:	0.00	2.00	1.00	1.00	2.00	0.00	0.00	0.00	0.00	0.00	0.00	1.00
Final Sat.:	0	3800	1750	1750	3800	0	0	0	0	0	0	1750
Capacity Analysis Module:												
Vol/Sat:	0.00	0.39	0.02	0.13	0.43	0.00	0.00	0.00	0.00	0.00	0.00	0.04
Crit Moves:	****		****									****
Green Time:	0.0	65.0	65.0	22.0	87.0	0.0	0.0	0.0	0.0	0.0	0.0	10.0
Volume/Cap:	0.00	0.60	0.03	0.60	0.49	0.00	0.00	0.00	0.00	0.00	0.00	0.40
Delay/Veh:	0.0	10.4	6.2	37.7	1.6	0.0	0.0	0.0	0.0	0.0	0.0	43.7
User DelAdj:	1.00	1.00	1.00	1.00	1.00	1.00	1.00	1.00	1.00	1.00	1.00	1.00
AdjDel/Veh:	0.0	10.4	6.2	37.7	1.6	0.0	0.0	0.0	0.0	0.0	0.0	43.7
LOS by Move:	A	B+	A	D+	A	A	A	A	A	A	A	D
HCM2kAvgQ:	0	13	0	7	6	0	0	0	0	0	0	3

Note: Queue reported is the number of cars per lane.

San Antonio Village Phase III MTA
 SJ21-2068
 Background AM

Level Of Service Computation Report
 2000 HCM Operations (Future Volume Alternative)
 Background AM

Intersection #10: California Street and San Antonio Road

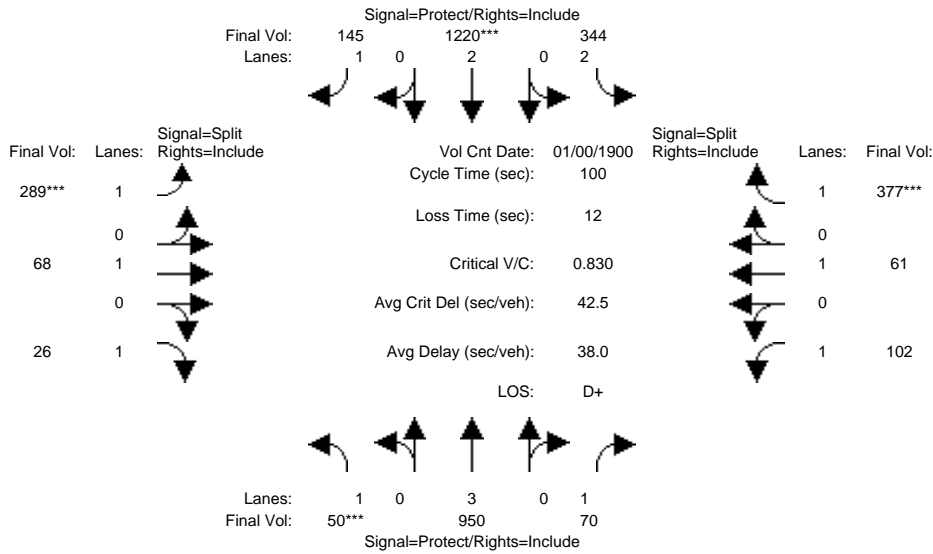

Approach:	North Bound			South Bound			East Bound			West Bound		
	L	T	R	L	T	R	L	T	R	L	T	R
Min. Green:	7	10	10	7	10	10	10	10	10	10	10	10
Y+R:	4.0	4.0	4.0	4.0	4.0	4.0	4.0	4.0	4.0	4.0	4.0	4.0
Volume Module: >> Count Date: 0 Jan 1900 << 12:00:00 AM												
Base Vol:	50	902	68	340	1141	145	289	68	26	101	61	377
Growth Adj:	1.00	1.00	1.00	1.00	1.00	1.00	1.00	1.00	1.00	1.00	1.00	1.00
Initial Bse:	50	902	68	340	1141	145	289	68	26	101	61	377
Added Vol:	0	48	2	4	79	0	0	0	0	1	0	0
PasserByVol:	0	0	0	0	0	0	0	0	0	0	0	0
Initial Fut:	50	950	70	344	1220	145	289	68	26	102	61	377
User Adj:	1.00	1.00	1.00	1.00	1.00	1.00	1.00	1.00	1.00	1.00	1.00	1.00
PHF Adj:	1.00	1.00	1.00	1.00	1.00	1.00	1.00	1.00	1.00	1.00	1.00	1.00
PHF Volume:	50	950	70	344	1220	145	289	68	26	102	61	377
Reduct Vol:	0	0	0	0	0	0	0	0	0	0	0	0
Reduced Vol:	50	950	70	344	1220	145	289	68	26	102	61	377
PCE Adj:	1.00	1.00	1.00	1.00	1.00	1.00	1.00	1.00	1.00	1.00	1.00	1.00
MLF Adj:	1.00	1.00	1.00	1.00	1.00	1.00	1.00	1.00	1.00	1.00	1.00	1.00
FinalVolume:	50	950	70	344	1220	145	289	68	26	102	61	377
Saturation Flow Module:												
Sat/Lane:	1900	1900	1900	1900	1900	1900	1900	1900	1900	1900	1900	1900
Adjustment:	0.92	1.00	0.92	0.83	1.00	0.92	0.92	1.00	0.92	0.92	1.00	0.92
Lanes:	1.00	3.00	1.00	2.00	2.00	1.00	1.00	1.00	1.00	1.00	1.00	1.00
Final Sat.:	1750	5700	1750	3150	3800	1750	1750	1900	1750	1750	1900	1750
Capacity Analysis Module:												
Vol/Sat:	0.03	0.17	0.04	0.11	0.32	0.08	0.17	0.04	0.01	0.06	0.03	0.22
Crit Moves:	****			****			****					****
Green Time:	7.0	26.6	26.6	17.4	37.1	37.1	19.1	19.1	19.1	24.9	24.9	24.9
Volume/Cap:	0.41	0.63	0.15	0.63	0.87	0.22	0.87	0.19	0.08	0.23	0.13	0.87
Uniform Del:	44.5	32.3	28.0	38.3	29.2	21.6	39.2	34.0	33.2	30.0	29.2	36.0
IncrementDel:	2.2	0.8	0.2	2.3	5.9	0.2	20.5	0.3	0.1	0.3	0.1	16.5
InitQueueDel:	0.0	0.0	0.0	0.0	0.0	0.0	0.0	0.0	0.0	0.0	0.0	0.0
Delay Adj:	1.00	1.00	1.00	1.00	1.00	1.00	1.00	1.00	1.00	1.00	1.00	1.00
Delay/Veh:	46.7	33.1	28.2	40.5	35.1	21.8	59.7	34.2	33.3	30.2	29.3	52.5
User DelAdj:	1.00	1.00	1.00	1.00	1.00	1.00	1.00	1.00	1.00	1.00	1.00	1.00
AdjDel/Veh:	46.7	33.1	28.2	40.5	35.1	21.8	59.7	34.2	33.3	30.2	29.3	52.5
LOS by Move:	D	C-	C	D	D+	C+	E+	C-	C-	C	C	D-
HCM2kAvgQ:	2	9	2	6	18	3	12	2	1	3	1	13

Note: Queue reported is the number of cars per lane.

San Antonio Village Phase III MTA
 SJ21-2068
 Background AM

Level Of Service Computation Report
 2000 HCM Operations (Future Volume Alternative)
 Background PP AM

Intersection #10: California Street and San Antonio Road

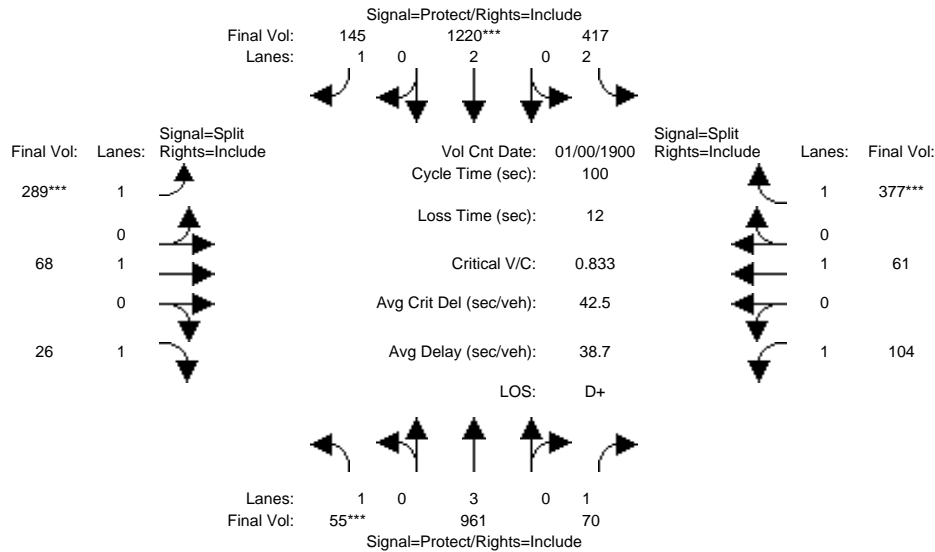

Approach:	North Bound			South Bound			East Bound			West Bound		
	L	T	R	L	T	R	L	T	R	L	T	R
Min. Green:	7	10	10	7	10	10	10	10	10	10	10	10
Y+R:	4.0	4.0	4.0	4.0	4.0	4.0	4.0	4.0	4.0	4.0	4.0	4.0
Volume Module: >> Count Date: 0 Jan 1900 << 12:00:00 AM												
Base Vol:	50	902	68	340	1141	145	289	68	26	101	61	377
Growth Adj:	1.00	1.00	1.00	1.00	1.00	1.00	1.00	1.00	1.00	1.00	1.00	1.00
Initial Bse:	50	902	68	340	1141	145	289	68	26	101	61	377
Added Vol:	5	59	2	77	79	0	0	0	0	3	0	0
PasserByVol:	0	0	0	0	0	0	0	0	0	0	0	0
Initial Fut:	55	961	70	417	1220	145	289	68	26	104	61	377
User Adj:	1.00	1.00	1.00	1.00	1.00	1.00	1.00	1.00	1.00	1.00	1.00	1.00
PHF Adj:	1.00	1.00	1.00	1.00	1.00	1.00	1.00	1.00	1.00	1.00	1.00	1.00
PHF Volume:	55	961	70	417	1220	145	289	68	26	104	61	377
Reduct Vol:	0	0	0	0	0	0	0	0	0	0	0	0
Reduced Vol:	55	961	70	417	1220	145	289	68	26	104	61	377
PCE Adj:	1.00	1.00	1.00	1.00	1.00	1.00	1.00	1.00	1.00	1.00	1.00	1.00
MLF Adj:	1.00	1.00	1.00	1.00	1.00	1.00	1.00	1.00	1.00	1.00	1.00	1.00
Final Volume:	55	961	70	417	1220	145	289	68	26	104	61	377
Saturation Flow Module:												
Sat/Lane:	1900	1900	1900	1900	1900	1900	1900	1900	1900	1900	1900	1900
Adjustment:	0.92	1.00	0.92	0.83	1.00	0.92	0.92	1.00	0.92	0.92	1.00	0.92
Lanes:	1.00	3.00	1.00	2.00	2.00	1.00	1.00	1.00	1.00	1.00	1.00	1.00
Final Sat.:	1750	5700	1750	3150	3800	1750	1750	1900	1750	1750	1900	1750
Capacity Analysis Module:												
Vol/Sat:	0.03	0.17	0.04	0.13	0.32	0.08	0.17	0.04	0.01	0.06	0.03	0.22
Crit Moves:	****			****			****					****
Green Time:	7.0	24.7	24.7	19.4	37.1	37.1	19.1	19.1	19.1	24.9	24.9	24.9
Volume/Cap:	0.45	0.68	0.16	0.68	0.87	0.22	0.87	0.19	0.08	0.24	0.13	0.87
Delay/Veh:	47.3	35.5	29.7	40.6	35.1	21.8	59.7	34.2	33.3	30.3	29.3	52.5
User DelAdj:	1.00	1.00	1.00	1.00	1.00	1.00	1.00	1.00	1.00	1.00	1.00	1.00
AdjDel/Veh:	47.3	35.5	29.7	40.6	35.1	21.8	59.7	34.2	33.3	30.3	29.3	52.5
LOS by Move:	D	D+	C	D	D+	C+	E+	C-	C-	C	C	D-
HCM2kAvgQ:	2	9	2	7	18	3	12	2	1	3	1	13

Note: Queue reported is the number of cars per lane.

San Antonio Village Phase III MTA
 SJ21-2068
 Background AM

Level Of Service Computation Report
 2000 HCM Operations (Future Volume Alternative)
 Background AM

Intersection #11: California Street and Pacchetti Way

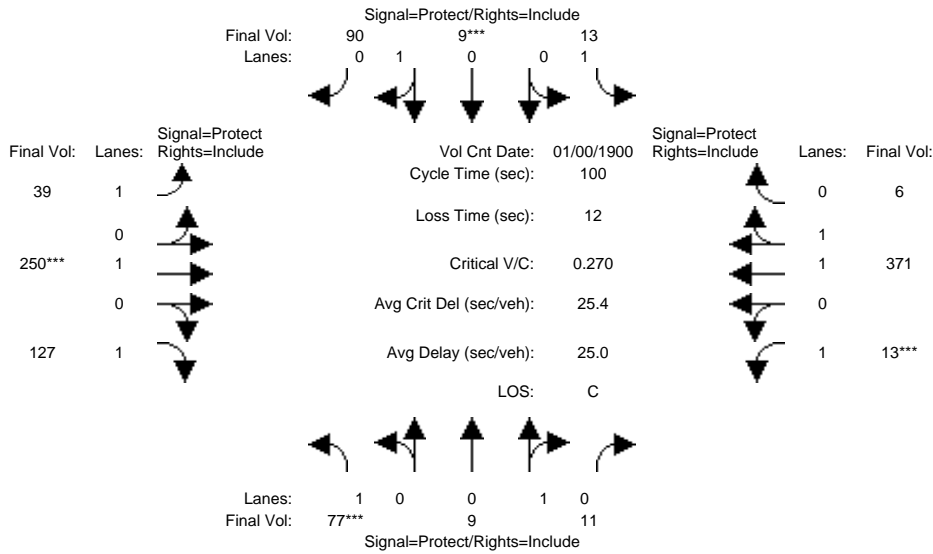

Approach:	North Bound			South Bound			East Bound			West Bound		
Movement:	L	T	R	L	T	R	L	T	R	L	T	R
Min. Green:	7	10	10	7	10	10	7	10	10	7	10	10
Y+R:	4.0	4.0	4.0	4.0	4.0	4.0	4.0	4.0	4.0	4.0	4.0	4.0
Volume Module: >> Count Date: 0 Jan 1900 << 12:00:00 AM												
Base Vol:	77	9	11	13	9	90	39	245	127	13	370	6
Growth Adj:	1.00	1.00	1.00	1.00	1.00	1.00	1.00	1.00	1.00	1.00	1.00	1.00
Initial Bse:	77	9	11	13	9	90	39	245	127	13	370	6
Added Vol:	0	0	0	0	0	0	0	5	0	0	1	0
PasserByVol:	0	0	0	0	0	0	0	0	0	0	0	0
Initial Fut:	77	9	11	13	9	90	39	250	127	13	371	6
User Adj:	1.00	1.00	1.00	1.00	1.00	1.00	1.00	1.00	1.00	1.00	1.00	1.00
PHF Adj:	1.00	1.00	1.00	1.00	1.00	1.00	1.00	1.00	1.00	1.00	1.00	1.00
PHF Volume:	77	9	11	13	9	90	39	250	127	13	371	6
Reduct Vol:	0	0	0	0	0	0	0	0	0	0	0	0
Reduced Vol:	77	9	11	13	9	90	39	250	127	13	371	6
PCE Adj:	1.00	1.00	1.00	1.00	1.00	1.00	1.00	1.00	1.00	1.00	1.00	1.00
MLF Adj:	1.00	1.00	1.00	1.00	1.00	1.00	1.00	1.00	1.00	1.00	1.00	1.00
FinalVolume:	77	9	11	13	9	90	39	250	127	13	371	6
Saturation Flow Module:												
Sat/Lane:	1900	1900	1900	1900	1900	1900	1900	1900	1900	1900	1900	1900
Adjustment:	0.92	0.95	0.95	0.92	0.95	0.95	0.92	1.00	0.92	0.92	0.97	0.95
Lanes:	1.00	0.45	0.55	1.00	0.09	0.91	1.00	1.00	1.00	1.00	1.97	0.03
Final Sat.:	1750	810	990	1750	164	1636	1750	1900	1750	1750	3641	59
Capacity Analysis Module:												
Vol/Sat:	0.04	0.01	0.01	0.01	0.06	0.06	0.02	0.13	0.07	0.01	0.10	0.10
Crit Moves:	****				****			****		****		
Green Time:	15.5	20.5	20.5	14.3	19.3	19.3	21.7	46.2	46.2	7.0	31.5	31.5
Volume/Cap:	0.28	0.05	0.05	0.05	0.28	0.28	0.10	0.28	0.16	0.11	0.32	0.32
Uniform Del:	37.4	32.0	32.0	37.0	34.4	34.4	31.4	16.7	15.6	43.6	26.1	26.1
IncrementDel:	0.6	0.1	0.1	0.1	0.5	0.5	0.1	0.2	0.1	0.4	0.2	0.2
InitQueueDel:	0.0	0.0	0.0	0.0	0.0	0.0	0.0	0.0	0.0	0.0	0.0	0.0
Delay Adj:	1.00	1.00	1.00	1.00	1.00	1.00	1.00	1.00	1.00	1.00	1.00	1.00
Delay/Veh:	38.0	32.1	32.1	37.1	34.9	34.9	31.5	16.8	15.7	44.0	26.2	26.2
User DelAdj:	1.00	1.00	1.00	1.00	1.00	1.00	1.00	1.00	1.00	1.00	1.00	1.00
AdjDel/Veh:	38.0	32.1	32.1	37.1	34.9	34.9	31.5	16.8	15.7	44.0	26.2	26.2
LOS by Move:	D+	C-	C-	D+	C-	C-	C	B	B	D	C	C
HCM2kAvgQ:	2	1	1	0	3	3	1	5	2	0	4	4

Note: Queue reported is the number of cars per lane.

San Antonio Village Phase III MTA
 SJ21-2068
 Background AM

Level Of Service Computation Report
 2000 HCM Operations (Future Volume Alternative)
 Background PP AM

Intersection #11: California Street and Pacchetti Way

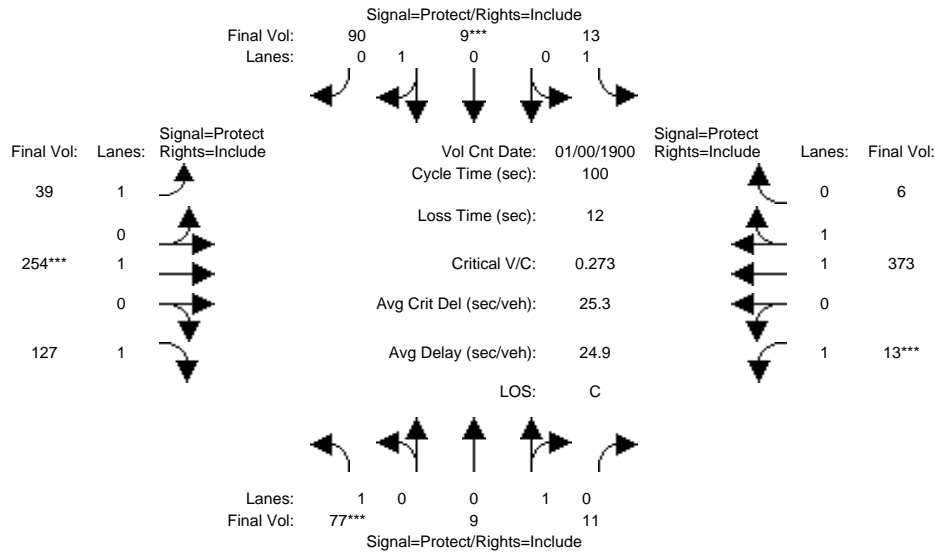

Approach:	North Bound			South Bound			East Bound			West Bound		
	L	T	R	L	T	R	L	T	R	L	T	R
Min. Green:	7	10	10	7	10	10	7	10	10	7	10	10
Y+R:	4.0	4.0	4.0	4.0	4.0	4.0	4.0	4.0	4.0	4.0	4.0	4.0
Volume Module: >> Count Date: 0 Jan 1900 << 12:00:00 AM												
Base Vol:	77	9	11	13	9	90	39	245	127	13	370	6
Growth Adj:	1.00	1.00	1.00	1.00	1.00	1.00	1.00	1.00	1.00	1.00	1.00	1.00
Initial Bse:	77	9	11	13	9	90	39	245	127	13	370	6
Added Vol:	0	0	0	0	0	0	0	9	0	0	3	0
PasserByVol:	0	0	0	0	0	0	0	0	0	0	0	0
Initial Fut:	77	9	11	13	9	90	39	254	127	13	373	6
User Adj:	1.00	1.00	1.00	1.00	1.00	1.00	1.00	1.00	1.00	1.00	1.00	1.00
PHF Adj:	1.00	1.00	1.00	1.00	1.00	1.00	1.00	1.00	1.00	1.00	1.00	1.00
PHF Volume:	77	9	11	13	9	90	39	254	127	13	373	6
Reduct Vol:	0	0	0	0	0	0	0	0	0	0	0	0
Reduced Vol:	77	9	11	13	9	90	39	254	127	13	373	6
PCE Adj:	1.00	1.00	1.00	1.00	1.00	1.00	1.00	1.00	1.00	1.00	1.00	1.00
MLF Adj:	1.00	1.00	1.00	1.00	1.00	1.00	1.00	1.00	1.00	1.00	1.00	1.00
FinalVolume:	77	9	11	13	9	90	39	254	127	13	373	6
Saturation Flow Module:												
Sat/Lane:	1900	1900	1900	1900	1900	1900	1900	1900	1900	1900	1900	1900
Adjustment:	0.92	0.95	0.95	0.92	0.95	0.95	0.92	1.00	0.92	0.92	0.97	0.95
Lanes:	1.00	0.45	0.55	1.00	0.09	0.91	1.00	1.00	1.00	1.00	1.97	0.03
Final Sat.:	1750	810	990	1750	164	1636	1750	1900	1750	1750	3641	59
Capacity Analysis Module:												
Vol/Sat:	0.04	0.01	0.01	0.01	0.06	0.06	0.02	0.13	0.07	0.01	0.10	0.10
Crit Moves:	****				****			****		****		
Green Time:	15.3	20.3	20.3	14.2	19.1	19.1	21.7	46.5	46.5	7.0	31.8	31.8
Volume/Cap:	0.29	0.05	0.05	0.05	0.29	0.29	0.10	0.29	0.16	0.11	0.32	0.32
Delay/Veh:	38.1	32.2	32.2	37.2	35.1	35.1	31.4	16.7	15.5	44.0	26.1	26.1
User DelAdj:	1.00	1.00	1.00	1.00	1.00	1.00	1.00	1.00	1.00	1.00	1.00	1.00
AdjDel/Veh:	38.1	32.2	32.2	37.2	35.1	35.1	31.4	16.7	15.5	44.0	26.1	26.1
LOS by Move:	D+	C-	C-	D+	D+	D+	C	B	B	D	C	C
HCM2kAvgQ:	2	1	1	0	3	3	1	5	2	0	4	4

Note: Queue reported is the number of cars per lane.

San Antonio Village Phase III MTA
 SJ21-2068
 Background AM

Level Of Service Computation Report
 2000 HCM Operations (Future Volume Alternative)
 Background AM

Intersection #12: California Street and Showers Drive

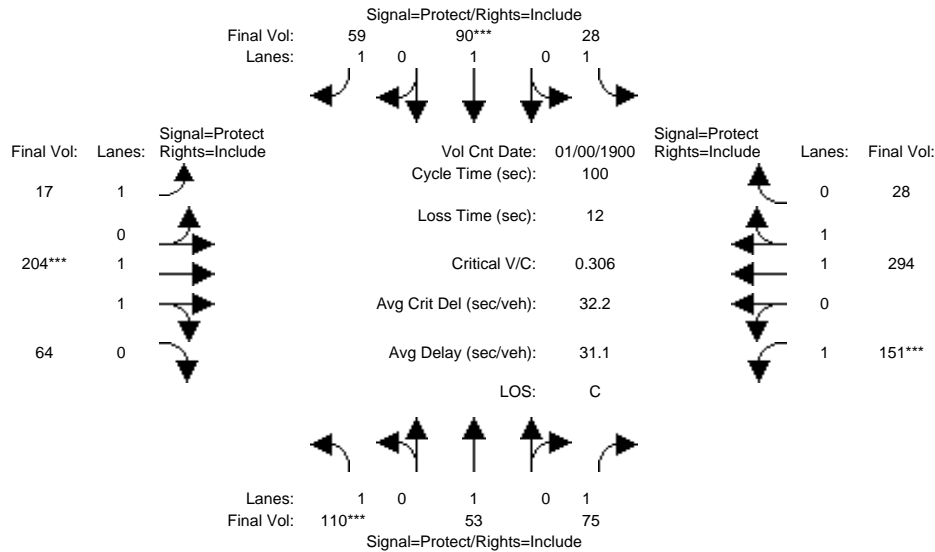

Approach:	North Bound			South Bound			East Bound			West Bound		
	L	T	R	L	T	R	L	T	R	L	T	R
Min. Green:	7	10	10	7	10	10	7	10	10	7	10	10
Y+R:	4.0	4.0	4.0	4.0	4.0	4.0	4.0	4.0	4.0	4.0	4.0	4.0
Volume Module: >> Count Date: 0 Jan 1900 << 12:00:00 AM												
Base Vol:	110	53	75	28	90	59	17	199	64	151	293	28
Growth Adj:	1.00	1.00	1.00	1.00	1.00	1.00	1.00	1.00	1.00	1.00	1.00	1.00
Initial Bse:	110	53	75	28	90	59	17	199	64	151	293	28
Added Vol:	0	0	0	0	0	0	0	5	0	0	1	0
PasserByVol:	0	0	0	0	0	0	0	0	0	0	0	0
Initial Fut:	110	53	75	28	90	59	17	204	64	151	294	28
User Adj:	1.00	1.00	1.00	1.00	1.00	1.00	1.00	1.00	1.00	1.00	1.00	1.00
PHF Adj:	1.00	1.00	1.00	1.00	1.00	1.00	1.00	1.00	1.00	1.00	1.00	1.00
PHF Volume:	110	53	75	28	90	59	17	204	64	151	294	28
Reduct Vol:	0	0	0	0	0	0	0	0	0	0	0	0
Reduced Vol:	110	53	75	28	90	59	17	204	64	151	294	28
PCE Adj:	1.00	1.00	1.00	1.00	1.00	1.00	1.00	1.00	1.00	1.00	1.00	1.00
MLF Adj:	1.00	1.00	1.00	1.00	1.00	1.00	1.00	1.00	1.00	1.00	1.00	1.00
FinalVolume:	110	53	75	28	90	59	17	204	64	151	294	28
Saturation Flow Module:												
Sat/Lane:	1900	1900	1900	1900	1900	1900	1900	1900	1900	1900	1900	1900
Adjustment:	0.92	1.00	0.92	0.92	1.00	0.92	0.92	0.98	0.95	0.92	0.98	0.95
Lanes:	1.00	1.00	1.00	1.00	1.00	1.00	1.00	1.51	0.49	1.00	1.82	0.18
Final Sat.:	1750	1900	1750	1750	1900	1750	1750	2816	883	1750	3378	322
Capacity Analysis Module:												
Vol/Sat:	0.06	0.03	0.04	0.02	0.05	0.03	0.01	0.07	0.07	0.09	0.09	0.09
Crit Moves:	****				****			****		****		
Green Time:	20.6	21.2	21.2	14.8	15.5	15.5	21.4	23.7	23.7	28.2	30.6	30.6
Volume/Cap:	0.31	0.13	0.20	0.11	0.31	0.22	0.05	0.31	0.31	0.31	0.28	0.28
Uniform Del:	33.7	31.9	32.4	36.8	37.5	36.9	31.2	31.4	31.4	28.2	26.4	26.4
IncrcmntDel:	0.5	0.1	0.3	0.2	0.6	0.4	0.1	0.2	0.2	0.4	0.1	0.1
InitQueuDel:	0.0	0.0	0.0	0.0	0.0	0.0	0.0	0.0	0.0	0.0	0.0	0.0
Delay Adj:	1.00	1.00	1.00	1.00	1.00	1.00	1.00	1.00	1.00	1.00	1.00	1.00
Delay/Veh:	34.1	32.1	32.7	37.0	38.1	37.4	31.3	31.6	31.6	28.5	26.6	26.6
User DelAdj:	1.00	1.00	1.00	1.00	1.00	1.00	1.00	1.00	1.00	1.00	1.00	1.00
AdjDel/Veh:	34.1	32.1	32.7	37.0	38.1	37.4	31.3	31.6	31.6	28.5	26.6	26.6
LOS by Move:	C-	C-	C-	D+	D+	D+	C	C	C	C	C	C
HCM2kAvgQ:	3	1	2	1	3	2	0	3	3	4	4	4

Note: Queue reported is the number of cars per lane.

San Antonio Village Phase III MTA
 SJ21-2068
 Background AM

Level Of Service Computation Report
 2000 HCM Operations (Future Volume Alternative)
 Background PP AM

Intersection #12: California Street and Showers Drive

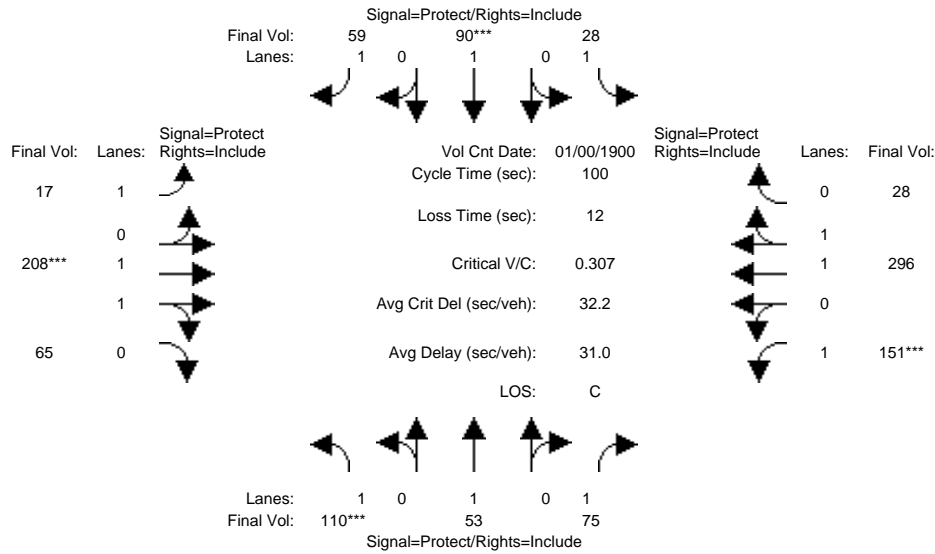

Approach:	North Bound			South Bound			East Bound			West Bound		
Movement:	L	T	R	L	T	R	L	T	R	L	T	R
Min. Green:	7	10	10	7	10	10	7	10	10	7	10	10
Y+R:	4.0	4.0	4.0	4.0	4.0	4.0	4.0	4.0	4.0	4.0	4.0	4.0
Volume Module: >> Count Date: 0 Jan 1900 << 12:00:00 AM												
Base Vol:	110	53	75	28	90	59	17	199	64	151	293	28
Growth Adj:	1.00	1.00	1.00	1.00	1.00	1.00	1.00	1.00	1.00	1.00	1.00	1.00
Initial Bse:	110	53	75	28	90	59	17	199	64	151	293	28
Added Vol:	0	0	0	0	0	0	0	9	1	0	3	0
PasserByVol:	0	0	0	0	0	0	0	0	0	0	0	0
Initial Fut:	110	53	75	28	90	59	17	208	65	151	296	28
User Adj:	1.00	1.00	1.00	1.00	1.00	1.00	1.00	1.00	1.00	1.00	1.00	1.00
PHF Adj:	1.00	1.00	1.00	1.00	1.00	1.00	1.00	1.00	1.00	1.00	1.00	1.00
PHF Volume:	110	53	75	28	90	59	17	208	65	151	296	28
Reduct Vol:	0	0	0	0	0	0	0	0	0	0	0	0
Reduced Vol:	110	53	75	28	90	59	17	208	65	151	296	28
PCE Adj:	1.00	1.00	1.00	1.00	1.00	1.00	1.00	1.00	1.00	1.00	1.00	1.00
MLF Adj:	1.00	1.00	1.00	1.00	1.00	1.00	1.00	1.00	1.00	1.00	1.00	1.00
Final Volume:	110	53	75	28	90	59	17	208	65	151	296	28
Saturation Flow Module:												
Sat/Lane:	1900	1900	1900	1900	1900	1900	1900	1900	1900	1900	1900	1900
Adjustment:	0.92	1.00	0.92	0.92	1.00	0.92	0.92	0.98	0.95	0.92	0.98	0.95
Lanes:	1.00	1.00	1.00	1.00	1.00	1.00	1.00	1.51	0.49	1.00	1.82	0.18
Final Sat.:	1750	1900	1750	1750	1900	1750	1750	2818	881	1750	3380	320
Capacity Analysis Module:												
Vol/Sat:	0.06	0.03	0.04	0.02	0.05	0.03	0.01	0.07	0.07	0.09	0.09	0.09
Crit Moves:	****			****			****			****		
Green Time:	20.5	21.1	21.1	14.8	15.4	15.4	21.5	24.0	24.0	28.1	30.7	30.7
Volume/Cap:	0.31	0.13	0.20	0.11	0.31	0.22	0.05	0.31	0.31	0.31	0.29	0.29
Delay/Veh:	34.2	32.2	32.8	37.1	38.1	37.4	31.2	31.4	31.4	28.7	26.5	26.5
User DelAdj:	1.00	1.00	1.00	1.00	1.00	1.00	1.00	1.00	1.00	1.00	1.00	1.00
AdjDel/Veh:	34.2	32.2	32.8	37.1	38.1	37.4	31.2	31.4	31.4	28.7	26.5	26.5
LOS by Move:	C-	C-	C-	D+	D+	D+	C	C	C	C	C	C
HCM2kAvgQ:	3	1	2	1	3	2	0	3	3	4	4	4

Note: Queue reported is the number of cars per lane.

San Antonio Village Phase III MTA
 SJ21-2068
 Background AM

Level Of Service Computation Report
 2000 HCM Operations (Future Volume Alternative)
 Background AM

Intersection #13: California Street and Ortega Avenue

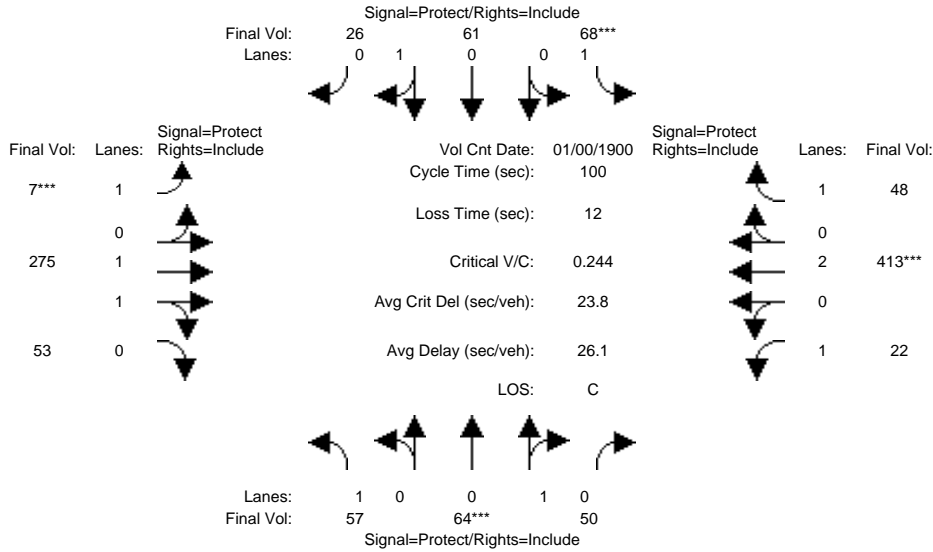

Approach:	North Bound			South Bound			East Bound			West Bound		
Movement:	L	T	R	L	T	R	L	T	R	L	T	R
Min. Green:	7	10	10	7	10	10	7	10	10	7	10	10
Y+R:	4.0	4.0	4.0	4.0	4.0	4.0	4.0	4.0	4.0	4.0	4.0	4.0
Volume Module: >> Count Date: 0 Jan 1900 << 12:00:00 AM												
Base Vol:	57	64	50	68	61	26	7	270	53	22	412	48
Growth Adj:	1.00	1.00	1.00	1.00	1.00	1.00	1.00	1.00	1.00	1.00	1.00	1.00
Initial Bse:	57	64	50	68	61	26	7	270	53	22	412	48
Added Vol:	0	0	0	0	0	0	0	5	0	0	1	0
PasserByVol:	0	0	0	0	0	0	0	0	0	0	0	0
Initial Fut:	57	64	50	68	61	26	7	275	53	22	413	48
User Adj:	1.00	1.00	1.00	1.00	1.00	1.00	1.00	1.00	1.00	1.00	1.00	1.00
PHF Adj:	1.00	1.00	1.00	1.00	1.00	1.00	1.00	1.00	1.00	1.00	1.00	1.00
PHF Volume:	57	64	50	68	61	26	7	275	53	22	413	48
Reduct Vol:	0	0	0	0	0	0	0	0	0	0	0	0
Reduced Vol:	57	64	50	68	61	26	7	275	53	22	413	48
PCE Adj:	1.00	1.00	1.00	1.00	1.00	1.00	1.00	1.00	1.00	1.00	1.00	1.00
MLF Adj:	1.00	1.00	1.00	1.00	1.00	1.00	1.00	1.00	1.00	1.00	1.00	1.00
FinalVolume:	57	64	50	68	61	26	7	275	53	22	413	48
Saturation Flow Module:												
Sat/Lane:	1900	1900	1900	1900	1900	1900	1900	1900	1900	1900	1900	1900
Adjustment:	0.92	0.95	0.95	0.92	0.95	0.95	0.92	0.98	0.95	0.92	1.00	0.92
Lanes:	1.00	0.56	0.44	1.00	0.70	0.30	1.00	1.67	0.33	1.00	2.00	1.00
Final Sat.:	1750	1011	789	1750	1262	538	1750	3102	598	1750	3800	1750
Capacity Analysis Module:												
Vol/Sat:	0.03	0.06	0.06	0.04	0.05	0.05	0.00	0.09	0.09	0.01	0.11	0.03
Crit Moves:	****			****			****			****		
Green Time:	16.2	24.3	24.3	14.9	23.1	23.1	7.0	28.7	28.7	20.1	41.7	41.7
Volume/Cap:	0.20	0.26	0.26	0.26	0.21	0.21	0.06	0.31	0.31	0.06	0.26	0.07
Uniform Del:	36.3	30.6	30.6	37.7	31.1	31.1	43.4	27.9	27.9	32.3	19.0	17.4
IncrcmntDel:	0.4	0.3	0.3	0.5	0.3	0.3	0.2	0.2	0.2	0.1	0.1	0.0
InitQueuDel:	0.0	0.0	0.0	0.0	0.0	0.0	0.0	0.0	0.0	0.0	0.0	0.0
Delay Adj:	1.00	1.00	1.00	1.00	1.00	1.00	1.00	1.00	1.00	1.00	1.00	1.00
Delay/Veh:	36.7	30.9	30.9	38.2	31.3	31.3	43.6	28.1	28.1	32.4	19.1	17.5
User DelAdj:	1.00	1.00	1.00	1.00	1.00	1.00	1.00	1.00	1.00	1.00	1.00	1.00
AdjDel/Veh:	36.7	30.9	30.9	38.2	31.3	31.3	43.6	28.1	28.1	32.4	19.1	17.5
LOS by Move:	D+	C	C	D+	C	C	D	C	C	C-	B-	B
HCM2kAvgQ:	2	3	3	2	2	2	0	4	4	1	4	1

Note: Queue reported is the number of cars per lane.

San Antonio Village Phase III MTA
 SJ21-2068
 Background AM

Level Of Service Computation Report
 2000 HCM Operations (Future Volume Alternative)
 Background PP AM

Intersection #13: California Street and Ortega Avenue

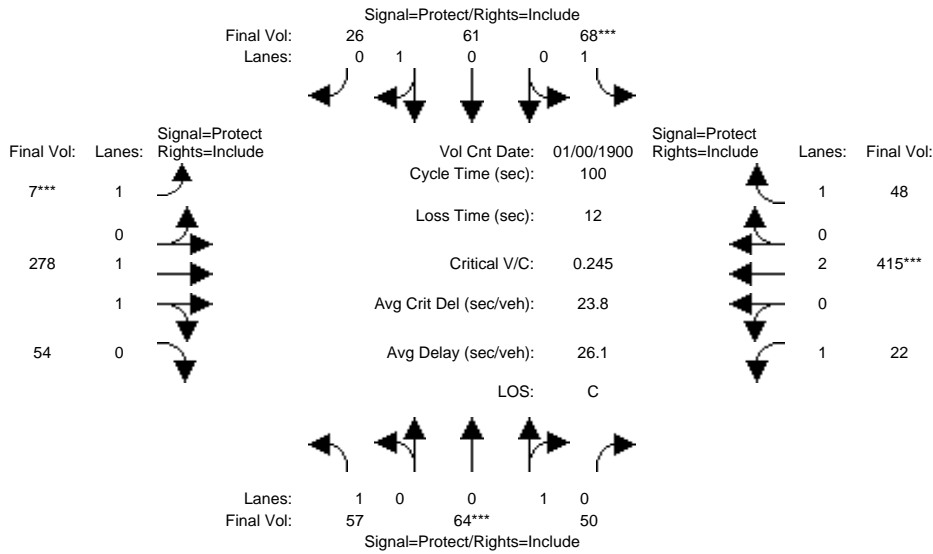

Approach:	North Bound			South Bound			East Bound			West Bound		
Movement:	L	T	R	L	T	R	L	T	R	L	T	R
Min. Green:	7	10	10	7	10	10	7	10	10	7	10	10
Y+R:	4.0	4.0	4.0	4.0	4.0	4.0	4.0	4.0	4.0	4.0	4.0	4.0
Volume Module: >> Count Date: 0 Jan 1900 << 12:00:00 AM												
Base Vol:	57	64	50	68	61	26	7	270	53	22	412	48
Growth Adj:	1.00	1.00	1.00	1.00	1.00	1.00	1.00	1.00	1.00	1.00	1.00	1.00
Initial Bse:	57	64	50	68	61	26	7	270	53	22	412	48
Added Vol:	0	0	0	0	0	0	0	8	1	0	3	0
PasserByVol:	0	0	0	0	0	0	0	0	0	0	0	0
Initial Fut:	57	64	50	68	61	26	7	278	54	22	415	48
User Adj:	1.00	1.00	1.00	1.00	1.00	1.00	1.00	1.00	1.00	1.00	1.00	1.00
PHF Adj:	1.00	1.00	1.00	1.00	1.00	1.00	1.00	1.00	1.00	1.00	1.00	1.00
PHF Volume:	57	64	50	68	61	26	7	278	54	22	415	48
Reduct Vol:	0	0	0	0	0	0	0	0	0	0	0	0
Reduced Vol:	57	64	50	68	61	26	7	278	54	22	415	48
PCE Adj:	1.00	1.00	1.00	1.00	1.00	1.00	1.00	1.00	1.00	1.00	1.00	1.00
MLF Adj:	1.00	1.00	1.00	1.00	1.00	1.00	1.00	1.00	1.00	1.00	1.00	1.00
Final Volume:	57	64	50	68	61	26	7	278	54	22	415	48
Saturation Flow Module:												
Sat/Lane:	1900	1900	1900	1900	1900	1900	1900	1900	1900	1900	1900	1900
Adjustment:	0.92	0.95	0.95	0.92	0.95	0.95	0.92	0.98	0.95	0.92	1.00	0.92
Lanes:	1.00	0.56	0.44	1.00	0.70	0.30	1.00	1.67	0.33	1.00	2.00	1.00
Final Sat.:	1750	1011	789	1750	1262	538	1750	3098	602	1750	3800	1750
Capacity Analysis Module:												
Vol/Sat:	0.03	0.06	0.06	0.04	0.05	0.05	0.00	0.09	0.09	0.01	0.11	0.03
Crit Moves:	****			****			****			****		
Green Time:	16.1	24.3	24.3	14.9	23.0	23.0	7.0	28.7	28.7	20.1	41.8	41.8
Volume/Cap:	0.20	0.26	0.26	0.26	0.21	0.21	0.06	0.31	0.31	0.06	0.26	0.07
Delay/Veh:	36.7	30.9	30.9	38.2	31.4	31.4	43.6	28.1	28.1	32.4	19.1	17.4
User DelAdj:	1.00	1.00	1.00	1.00	1.00	1.00	1.00	1.00	1.00	1.00	1.00	1.00
AdjDel/Veh:	36.7	30.9	30.9	38.2	31.4	31.4	43.6	28.1	28.1	32.4	19.1	17.4
LOS by Move:	D+	C	C	D+	C	C	D	C	C	C-	B-	B
HCM2kAvgQ:	2	3	3	2	2	2	0	4	4	1	4	1

Note: Queue reported is the number of cars per lane.

San Antonio Village Phase III MTA
 SJ21-2068
 Background AM

Level Of Service Computation Report
 2000 HCM Operations (Future Volume Alternative)
 Background AM

Intersection #14: California Street and Rengstorff Avenue

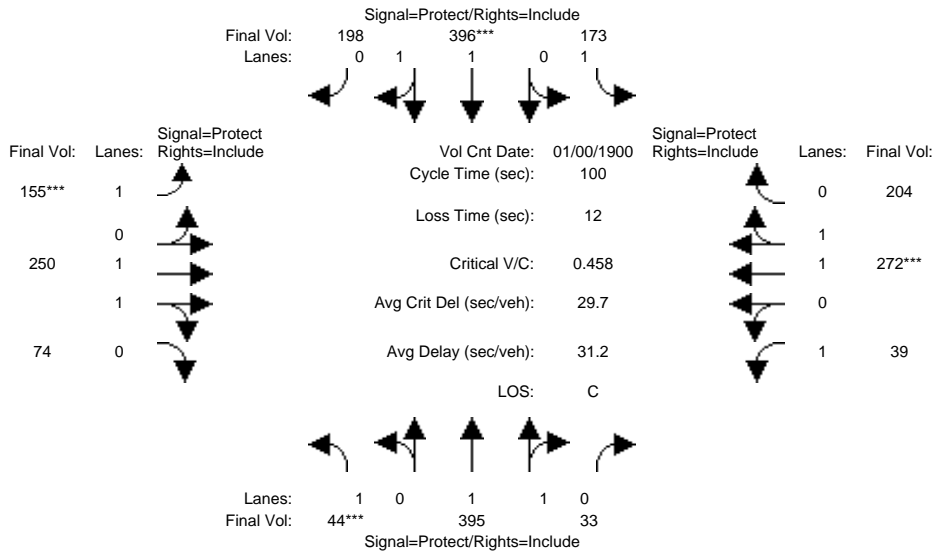

Approach:	North Bound			South Bound			East Bound			West Bound		
Movement:	L	T	R	L	T	R	L	T	R	L	T	R
Min. Green:	7	10	10	7	10	10	7	10	10	7	10	10
Y+R:	4.0	4.0	4.0	4.0	4.0	4.0	4.0	4.0	4.0	4.0	4.0	4.0
Volume Module: >> Count Date: 0 Jan 1900 << 12:00:00 AM												
Base Vol:	44	372	33	173	385	197	153	250	70	39	272	204
Growth Adj:	1.00	1.00	1.00	1.00	1.00	1.00	1.00	1.00	1.00	1.00	1.00	1.00
Initial Bse:	44	372	33	173	385	197	153	250	70	39	272	204
Added Vol:	0	23	0	0	11	1	2	0	4	0	0	0
PasserByVol:	0	0	0	0	0	0	0	0	0	0	0	0
Initial Fut:	44	395	33	173	396	198	155	250	74	39	272	204
User Adj:	1.00	1.00	1.00	1.00	1.00	1.00	1.00	1.00	1.00	1.00	1.00	1.00
PHF Adj:	1.00	1.00	1.00	1.00	1.00	1.00	1.00	1.00	1.00	1.00	1.00	1.00
PHF Volume:	44	395	33	173	396	198	155	250	74	39	272	204
Reduct Vol:	0	0	0	0	0	0	0	0	0	0	0	0
Reduced Vol:	44	395	33	173	396	198	155	250	74	39	272	204
PCE Adj:	1.00	1.00	1.00	1.00	1.00	1.00	1.00	1.00	1.00	1.00	1.00	1.00
MLF Adj:	1.00	1.00	1.00	1.00	1.00	1.00	1.00	1.00	1.00	1.00	1.00	1.00
Final Volume:	44	395	33	173	396	198	155	250	74	39	272	204
Saturation Flow Module:												
Sat/Lane:	1900	1900	1900	1900	1900	1900	1900	1900	1900	1900	1900	1900
Adjustment:	0.92	0.98	0.95	0.92	0.99	0.95	0.92	0.98	0.95	0.92	0.99	0.95
Lanes:	1.00	1.84	0.16	1.00	1.32	0.68	1.00	1.53	0.47	1.00	1.12	0.88
Final Sat.:	1750	3415	285	1750	2466	1233	1750	2854	845	1750	2113	1585
Capacity Analysis Module:												
Vol/Sat:	0.03	0.12	0.12	0.10	0.16	0.16	0.09	0.09	0.09	0.02	0.13	0.13
Crit Moves:	****			****			****			****		
Green Time:	7.0	22.3	22.3	19.1	34.4	34.4	19.0	27.4	27.4	19.2	27.6	27.6
Volume/Cap:	0.36	0.52	0.52	0.52	0.47	0.47	0.47	0.32	0.32	0.12	0.47	0.47
Uniform Del:	44.4	34.1	34.1	36.3	25.6	25.6	36.0	28.9	28.9	33.4	30.1	30.1
IncrementDel:	1.8	0.6	0.6	1.4	0.3	0.3	1.0	0.2	0.2	0.2	0.3	0.3
InitQueueDel:	0.0	0.0	0.0	0.0	0.0	0.0	0.0	0.0	0.0	0.0	0.0	0.0
Delay Adj:	1.00	1.00	1.00	1.00	1.00	1.00	1.00	1.00	1.00	1.00	1.00	1.00
Delay/Veh:	46.2	34.7	34.7	37.8	25.9	25.9	37.0	29.1	29.1	33.6	30.4	30.4
User DelAdj:	1.00	1.00	1.00	1.00	1.00	1.00	1.00	1.00	1.00	1.00	1.00	1.00
AdjDel/Veh:	46.2	34.7	34.7	37.8	25.9	25.9	37.0	29.1	29.1	33.6	30.4	30.4
LOS by Move:	D	C-	C-	D+	C	C	D+	C	C	C-	C	C
HCM2kAvgQ:	1	6	6	5	7	7	4	4	4	1	6	6

Note: Queue reported is the number of cars per lane.

San Antonio Village Phase III MTA
 SJ21-2068
 Background AM

Level Of Service Computation Report
 2000 HCM Operations (Future Volume Alternative)
 Background PP AM

Intersection #14: California Street and Rengstorff Avenue

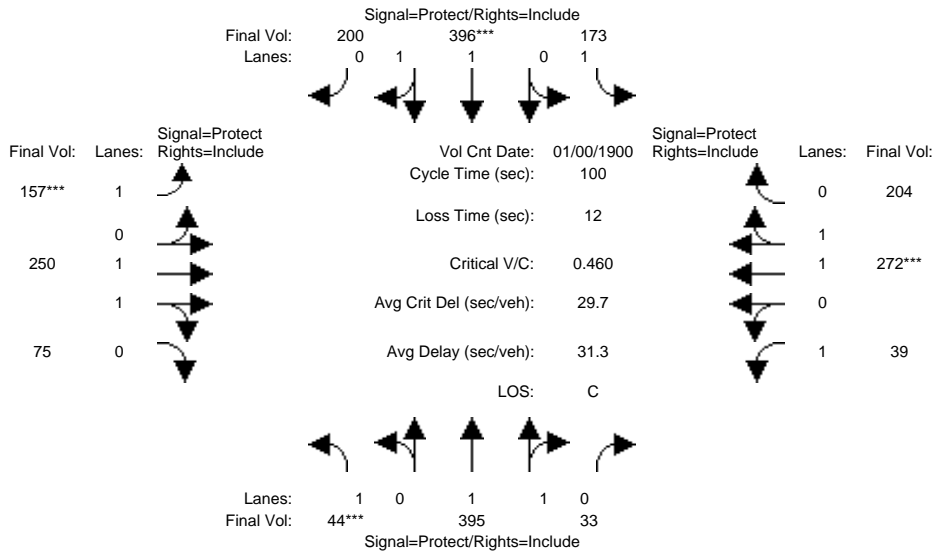

Approach:	North Bound			South Bound			East Bound			West Bound		
Movement:	L	T	R	L	T	R	L	T	R	L	T	R
Min. Green:	7	10	10	7	10	10	7	10	10	7	10	10
Y+R:	4.0	4.0	4.0	4.0	4.0	4.0	4.0	4.0	4.0	4.0	4.0	4.0
Volume Module: >> Count Date: 0 Jan 1900 << 12:00:00 AM												
Base Vol:	44	372	33	173	385	197	153	250	70	39	272	204
Growth Adj:	1.00	1.00	1.00	1.00	1.00	1.00	1.00	1.00	1.00	1.00	1.00	1.00
Initial Bse:	44	372	33	173	385	197	153	250	70	39	272	204
Added Vol:	0	23	0	0	11	3	4	0	5	0	0	0
PasserByVol:	0	0	0	0	0	0	0	0	0	0	0	0
Initial Fut:	44	395	33	173	396	200	157	250	75	39	272	204
User Adj:	1.00	1.00	1.00	1.00	1.00	1.00	1.00	1.00	1.00	1.00	1.00	1.00
PHF Adj:	1.00	1.00	1.00	1.00	1.00	1.00	1.00	1.00	1.00	1.00	1.00	1.00
PHF Volume:	44	395	33	173	396	200	157	250	75	39	272	204
Reduct Vol:	0	0	0	0	0	0	0	0	0	0	0	0
Reduced Vol:	44	395	33	173	396	200	157	250	75	39	272	204
PCE Adj:	1.00	1.00	1.00	1.00	1.00	1.00	1.00	1.00	1.00	1.00	1.00	1.00
MLF Adj:	1.00	1.00	1.00	1.00	1.00	1.00	1.00	1.00	1.00	1.00	1.00	1.00
Final Volume:	44	395	33	173	396	200	157	250	75	39	272	204
Saturation Flow Module:												
Sat/Lane:	1900	1900	1900	1900	1900	1900	1900	1900	1900	1900	1900	1900
Adjustment:	0.92	0.98	0.95	0.92	0.99	0.95	0.92	0.98	0.95	0.92	0.99	0.95
Lanes:	1.00	1.84	0.16	1.00	1.31	0.69	1.00	1.53	0.47	1.00	1.12	0.88
Final Sat.:	1750	3415	285	1750	2457	1241	1750	2846	854	1750	2113	1585
Capacity Analysis Module:												
Vol/Sat:	0.03	0.12	0.12	0.10	0.16	0.16	0.09	0.09	0.09	0.02	0.13	0.13
Crit Moves:	****			****			****			****		
Green Time:	7.0	22.3	22.3	19.1	34.4	34.4	19.1	27.4	27.4	19.2	27.5	27.5
Volume/Cap:	0.36	0.52	0.52	0.52	0.47	0.47	0.47	0.32	0.32	0.12	0.47	0.47
Delay/Veh:	46.2	34.7	34.7	37.8	25.9	25.9	36.9	29.1	29.1	33.5	30.5	30.5
User DelAdj:	1.00	1.00	1.00	1.00	1.00	1.00	1.00	1.00	1.00	1.00	1.00	1.00
AdjDel/Veh:	46.2	34.7	34.7	37.8	25.9	25.9	36.9	29.1	29.1	33.5	30.5	30.5
LOS by Move:	D	C-	C-	D+	C	C	D+	C	C	C-	C	C
HCM2kAvgQ:	1	6	6	5	7	7	5	4	4	1	7	7

Note: Queue reported is the number of cars per lane.

San Antonio Village Phase III MTA
 SJ21-2068
 Background AM

Level Of Service Computation Report
 2000 HCM Operations (Future Volume Alternative)
 Background AM

Intersection #15: Central Expressway and Rengstorff Avenue

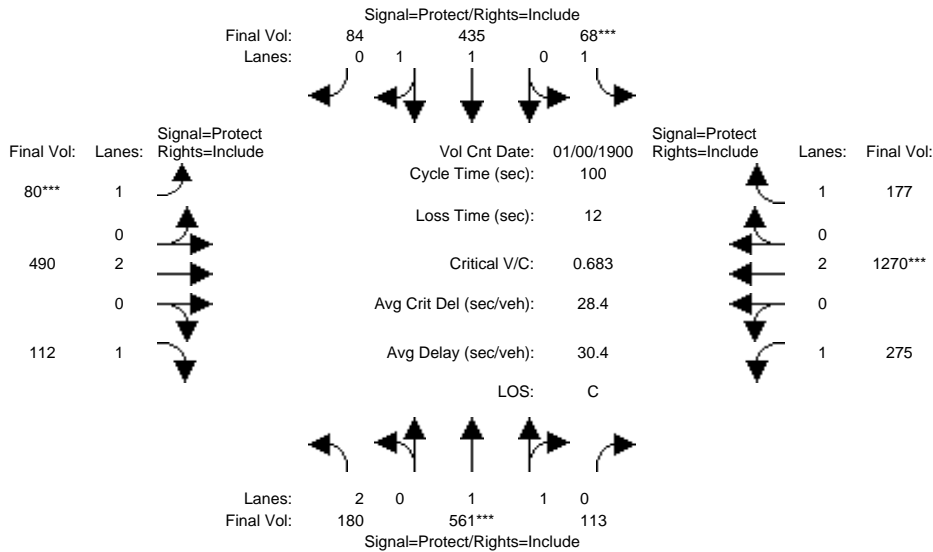

Approach:	North Bound			South Bound			East Bound			West Bound		
	L	T	R	L	T	R	L	T	R	L	T	R
Min. Green:	7	10	10	7	10	10	7	10	10	7	10	10
Y+R:	4.0	4.0	4.0	4.0	4.0	4.0	4.0	4.0	4.0	4.0	4.0	4.0
Volume Module: >> Count Date: 0 Jan 1900 << 12:00:00 AM												
Base Vol:	180	550	99	63	429	79	64	456	112	270	1264	175
Growth Adj:	1.00	1.00	1.00	1.00	1.00	1.00	1.00	1.00	1.00	1.00	1.00	1.00
Initial Bse:	180	550	99	63	429	79	64	456	112	270	1264	175
Added Vol:	0	11	14	5	6	5	16	34	0	5	6	2
PasserByVol:	0	0	0	0	0	0	0	0	0	0	0	0
Initial Fut:	180	561	113	68	435	84	80	490	112	275	1270	177
User Adj:	1.00	1.00	1.00	1.00	1.00	1.00	1.00	1.00	1.00	1.00	1.00	1.00
PHF Adj:	1.00	1.00	1.00	1.00	1.00	1.00	1.00	1.00	1.00	1.00	1.00	1.00
PHF Volume:	180	561	113	68	435	84	80	490	112	275	1270	177
Reduct Vol:	0	0	0	0	0	0	0	0	0	0	0	0
Reduced Vol:	180	561	113	68	435	84	80	490	112	275	1270	177
PCE Adj:	1.00	1.00	1.00	1.00	1.00	1.00	1.00	1.00	1.00	1.00	1.00	1.00
MLF Adj:	1.00	1.00	1.00	1.00	1.00	1.00	1.00	1.00	1.00	1.00	1.00	1.00
Final Volume:	180	561	113	68	435	84	80	490	112	275	1270	177
Saturation Flow Module:												
Sat/Lane:	1900	1900	1900	1900	1900	1900	1900	1900	1900	1900	1900	1900
Adjustment:	0.83	0.98	0.95	0.92	0.98	0.95	0.92	1.00	0.92	0.92	1.00	0.92
Lanes:	2.00	1.66	0.34	1.00	1.67	0.33	1.00	2.00	1.00	1.00	2.00	1.00
Final Sat.:	3150	3079	620	1750	3101	599	1750	3800	1750	1750	3800	1750
Capacity Analysis Module:												
Vol/Sat:	0.06	0.18	0.18	0.04	0.14	0.14	0.05	0.13	0.06	0.16	0.33	0.10
Crit Moves:	****			****			****			****		
Green Time:	11.0	26.1	26.1	7.0	22.1	22.1	7.0	24.7	24.7	30.2	47.9	47.9
Volume/Cap:	0.52	0.70	0.70	0.56	0.64	0.64	0.65	0.52	0.26	0.52	0.70	0.21
Uniform Del:	42.0	33.4	33.4	45.0	35.3	35.3	45.3	32.5	30.3	28.9	20.4	15.1
IncrcmntDel:	1.4	2.3	2.3	5.5	1.7	1.7	11.9	0.5	0.3	0.9	1.2	0.1
InitQueuDel:	0.0	0.0	0.0	0.0	0.0	0.0	0.0	0.0	0.0	0.0	0.0	0.0
Delay Adj:	1.00	1.00	1.00	1.00	1.00	1.00	1.00	1.00	1.00	1.00	1.00	1.00
Delay/Veh:	43.4	35.7	35.7	50.5	37.0	37.0	57.3	33.0	30.6	29.9	21.6	15.2
User DelAdj:	1.00	1.00	1.00	1.00	1.00	1.00	1.00	1.00	1.00	1.00	1.00	1.00
AdjDel/Veh:	43.4	35.7	35.7	50.5	37.0	37.0	57.3	33.0	30.6	29.9	21.6	15.2
LOS by Move:	D	D+	D+	D	D+	D+	E+	C-	C	C	C+	B
HCM2kAvgQ:	3	10	10	3	8	8	3	6	3	8	16	3

Note: Queue reported is the number of cars per lane.

San Antonio Village Phase III MTA
 SJ21-2068
 Background AM

Level Of Service Computation Report
 2000 HCM Operations (Future Volume Alternative)
 Background PP AM

Intersection #15: Central Expressway and Rengstorff Avenue

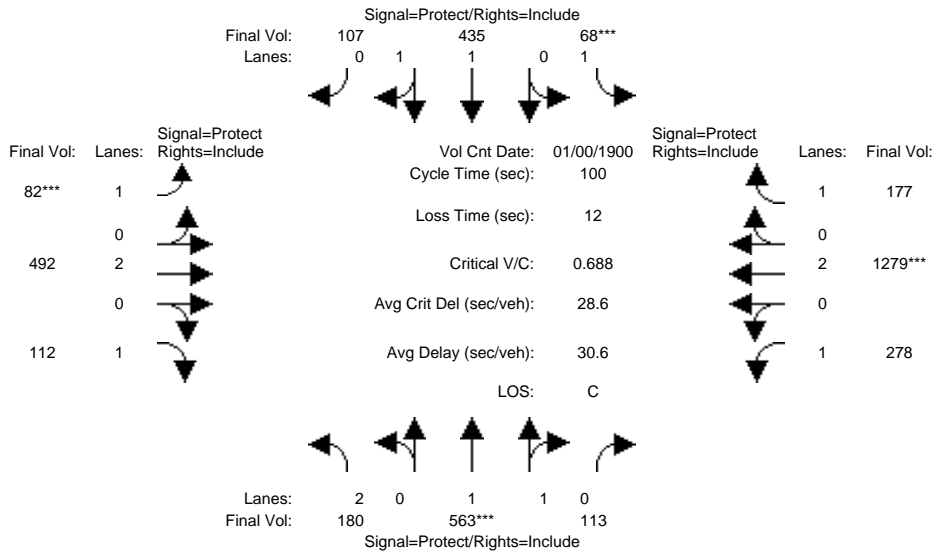

Approach:	North Bound			South Bound			East Bound			West Bound		
	L	T	R	L	T	R	L	T	R	L	T	R
Min. Green:	7	10	10	7	10	10	7	10	10	7	10	10
Y+R:	4.0	4.0	4.0	4.0	4.0	4.0	4.0	4.0	4.0	4.0	4.0	4.0
Volume Module: >> Count Date: 0 Jan 1900 << 12:00:00 AM												
Base Vol:	180	550	99	63	429	79	64	456	112	270	1264	175
Growth Adj:	1.00	1.00	1.00	1.00	1.00	1.00	1.00	1.00	1.00	1.00	1.00	1.00
Initial Bse:	180	550	99	63	429	79	64	456	112	270	1264	175
Added Vol:	0	13	14	5	6	28	18	36	0	8	15	2
PasserByVol:	0	0	0	0	0	0	0	0	0	0	0	0
Initial Fut:	180	563	113	68	435	107	82	492	112	278	1279	177
User Adj:	1.00	1.00	1.00	1.00	1.00	1.00	1.00	1.00	1.00	1.00	1.00	1.00
PHF Adj:	1.00	1.00	1.00	1.00	1.00	1.00	1.00	1.00	1.00	1.00	1.00	1.00
PHF Volume:	180	563	113	68	435	107	82	492	112	278	1279	177
Reduct Vol:	0	0	0	0	0	0	0	0	0	0	0	0
Reduced Vol:	180	563	113	68	435	107	82	492	112	278	1279	177
PCE Adj:	1.00	1.00	1.00	1.00	1.00	1.00	1.00	1.00	1.00	1.00	1.00	1.00
MLF Adj:	1.00	1.00	1.00	1.00	1.00	1.00	1.00	1.00	1.00	1.00	1.00	1.00
Final Volume:	180	563	113	68	435	107	82	492	112	278	1279	177
Saturation Flow Module:												
Sat/Lane:	1900	1900	1900	1900	1900	1900	1900	1900	1900	1900	1900	1900
Adjustment:	0.83	0.98	0.95	0.92	0.98	0.95	0.92	1.00	0.92	0.92	1.00	0.92
Lanes:	2.00	1.66	0.34	1.00	1.59	0.41	1.00	2.00	1.00	1.00	2.00	1.00
Final Sat.:	3150	3081	618	1750	2969	730	1750	3800	1750	1750	3800	1750
Capacity Analysis Module:												
Vol/Sat:	0.06	0.18	0.18	0.04	0.15	0.15	0.05	0.13	0.06	0.16	0.34	0.10
Crit Moves:	****			****			****			****		
Green Time:	10.7	26.0	26.0	7.0	22.4	22.4	7.0	24.7	24.7	30.3	48.0	48.0
Volume/Cap:	0.53	0.70	0.70	0.56	0.66	0.66	0.67	0.52	0.26	0.52	0.70	0.21
Delay/Veh:	44.0	35.8	35.8	50.5	37.2	37.2	58.8	33.1	30.6	29.9	21.7	15.2
User DelAdj:	1.00	1.00	1.00	1.00	1.00	1.00	1.00	1.00	1.00	1.00	1.00	1.00
AdjDel/Veh:	44.0	35.8	35.8	50.5	37.2	37.2	58.8	33.1	30.6	29.9	21.7	15.2
LOS by Move:	D	D+	D+	D	D+	D+	E+	C-	C	C	C+	B
HCM2kAvgQ:	3	10	10	3	9	9	3	6	3	8	16	3

Note: Queue reported is the number of cars per lane.

San Antonio Village Phase III MTA
 SJ21-2068
 Background AM

Level Of Service Computation Report
 2000 HCM Operations (Future Volume Alternative)
 Background AM

Intersection #16: Middlefield Road and San Antonio Road

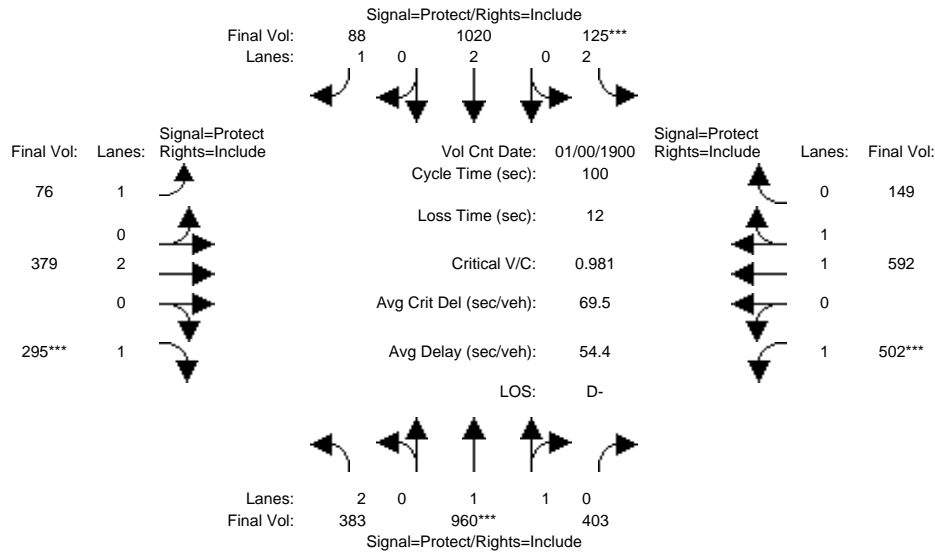

Approach:	North Bound			South Bound			East Bound			West Bound		
	L	T	R	L	T	R	L	T	R	L	T	R
Min. Green:	7	10	10	7	10	10	7	10	10	7	10	10
Y+R:	4.0	4.0	4.0	4.0	4.0	4.0	4.0	4.0	4.0	4.0	4.0	4.0

Volume Module:	>>	Count	Date:	0	Jan	1900	<<	12:	00:00	AM
Base Vol:	370	914	386	118	1005	81	72	370	294	495 569 129
Growth Adj:	1.00	1.00	1.00	1.00	1.00	1.00	1.00	1.00	1.00	1.00 1.00 1.00
Initial Bse:	370	914	386	118	1005	81	72	370	294	495 569 129
Added Vol:	13	46	17	7	15	7	4	9	1	7 23 20
PasserByVol:	0	0	0	0	0	0	0	0	0	0 0 0
Initial Fut:	383	960	403	125	1020	88	76	379	295	502 592 149
User Adj:	1.00	1.00	1.00	1.00	1.00	1.00	1.00	1.00	1.00	1.00 1.00 1.00
PHF Adj:	1.00	1.00	1.00	1.00	1.00	1.00	1.00	1.00	1.00	1.00 1.00 1.00
PHF Volume:	383	960	403	125	1020	88	76	379	295	502 592 149
Reduct Vol:	0	0	0	0	0	0	0	0	0	0 0 0
Reduced Vol:	383	960	403	125	1020	88	76	379	295	502 592 149
PCE Adj:	1.00	1.00	1.00	1.00	1.00	1.00	1.00	1.00	1.00	1.00 1.00 1.00
MLF Adj:	1.00	1.00	1.00	1.00	1.00	1.00	1.00	1.00	1.00	1.00 1.00 1.00
FinalVolume:	383	960	403	125	1020	88	76	379	295	502 592 149

Saturation Flow Module:	Sat/Lane:	1900	1900	1900	1900	1900	1900	1900	1900	1900	1900	1900
Adjustment:	0.83	0.98	0.95	0.83	1.00	0.92	0.92	1.00	0.92	0.92	0.98	0.95
Lanes:	2.00	1.39	0.61	2.00	2.00	1.00	1.00	2.00	1.00	1.00	1.59	0.41
Final Sat.:	3150	2605	1094	3150	3800	1750	1750	3800	1750	1750	2955	744

Capacity Analysis Module:	Vol/Sat:	0.12	0.37	0.37	0.04	0.27	0.05	0.04	0.10	0.17	0.29	0.20	0.20
Crit Moves:	****	****	****	****	****	****	****	****	****	****	****	****	****
Green Time:	13.5	36.2	36.2	7.0	29.8	29.8	11.6	16.6	16.6	28.2	33.2	33.2	33.2
Volume/Cap:	0.90	1.02	1.02	0.57	0.90	0.17	0.37	0.60	1.02	1.02	0.60	0.60	0.60
Uniform Del:	42.6	31.9	31.9	45.0	33.7	26.0	40.9	38.7	41.7	35.9	27.9	27.9	27.9
IncrcmntDel:	22.0	29.0	29.0	3.4	10.1	0.2	1.2	1.6	57.3	44.9	0.9	0.9	0.9
InitQueuDel:	0.0	0.0	0.0	0.0	0.0	0.0	0.0	0.0	0.0	0.0	0.0	0.0	0.0
Delay Adj:	1.00	1.00	1.00	1.00	1.00	1.00	1.00	1.00	1.00	1.00	1.00	1.00	1.00
Delay/Veh:	64.6	60.9	60.9	48.5	43.8	26.1	42.0	40.3	99.0	80.8	28.8	28.8	28.8
User DelAdj:	1.00	1.00	1.00	1.00	1.00	1.00	1.00	1.00	1.00	1.00	1.00	1.00	1.00
AdjDel/Veh:	64.6	60.9	60.9	48.5	43.8	26.1	42.0	40.3	99.0	80.8	28.8	28.8	28.8
LOS by Move:	E	E	E	D	D	C	D	D	F	F	C	C	C
HCM2kAvgQ:	8	27	27	2	17	2	3	6	16	24	10	10	10

Note: Queue reported is the number of cars per lane.

San Antonio Village Phase III MTA
 SJ21-2068
 Background AM

Level Of Service Computation Report
 2000 HCM Operations (Future Volume Alternative)
 Background PP AM

Intersection #16: Middlefield Road and San Antonio Road

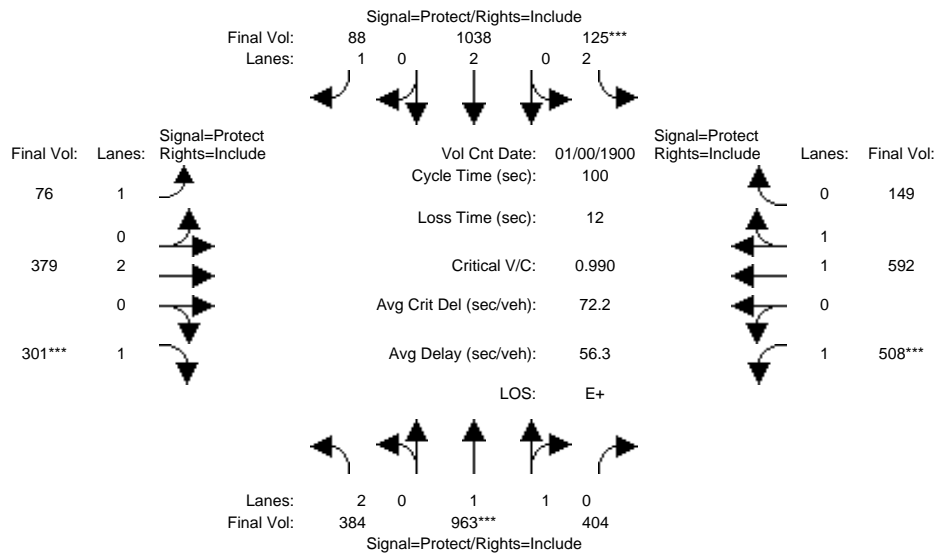

Approach:	North Bound			South Bound			East Bound			West Bound		
Movement:	L	T	R	L	T	R	L	T	R	L	T	R
Min. Green:	7	10	10	7	10	10	7	10	10	7	10	10
Y+R:	4.0	4.0	4.0	4.0	4.0	4.0	4.0	4.0	4.0	4.0	4.0	4.0
Volume Module: >> Count Date: 0 Jan 1900 << 12:00:00 AM												
Base Vol:	370	914	386	118	1005	81	72	370	294	495	569	129
Growth Adj:	1.00	1.00	1.00	1.00	1.00	1.00	1.00	1.00	1.00	1.00	1.00	1.00
Initial Bse:	370	914	386	118	1005	81	72	370	294	495	569	129
Added Vol:	14	49	18	7	33	7	4	9	7	13	23	20
PasserByVol:	0	0	0	0	0	0	0	0	0	0	0	0
Initial Fut:	384	963	404	125	1038	88	76	379	301	508	592	149
User Adj:	1.00	1.00	1.00	1.00	1.00	1.00	1.00	1.00	1.00	1.00	1.00	1.00
PHF Adj:	1.00	1.00	1.00	1.00	1.00	1.00	1.00	1.00	1.00	1.00	1.00	1.00
PHF Volume:	384	963	404	125	1038	88	76	379	301	508	592	149
Reduct Vol:	0	0	0	0	0	0	0	0	0	0	0	0
Reduced Vol:	384	963	404	125	1038	88	76	379	301	508	592	149
PCE Adj:	1.00	1.00	1.00	1.00	1.00	1.00	1.00	1.00	1.00	1.00	1.00	1.00
MLF Adj:	1.00	1.00	1.00	1.00	1.00	1.00	1.00	1.00	1.00	1.00	1.00	1.00
Final Volume:	384	963	404	125	1038	88	76	379	301	508	592	149
Saturation Flow Module:												
Sat/Lane:	1900	1900	1900	1900	1900	1900	1900	1900	1900	1900	1900	1900
Adjustment:	0.83	0.98	0.95	0.83	1.00	0.92	0.92	1.00	0.92	0.92	0.98	0.95
Lanes:	2.00	1.39	0.61	2.00	2.00	1.00	1.00	2.00	1.00	1.00	1.59	0.41
Final Sat.:	3150	2606	1093	3150	3800	1750	1750	3800	1750	1750	2955	744
Capacity Analysis Module:												
Vol/Sat:	0.12	0.37	0.37	0.04	0.27	0.05	0.04	0.10	0.17	0.29	0.20	0.20
Crit Moves:	****			****			****			****		
Green Time:	13.3	36.0	36.0	7.0	29.7	29.7	11.7	16.7	16.7	28.3	33.4	33.4
Volume/Cap:	0.92	1.03	1.03	0.57	0.92	0.17	0.37	0.60	1.03	1.03	0.60	0.60
Delay/Veh:	68.0	63.8	63.8	48.5	45.9	26.2	41.9	40.0	101.3	83.4	28.6	28.6
User DelAdj:	1.00	1.00	1.00	1.00	1.00	1.00	1.00	1.00	1.00	1.00	1.00	1.00
AdjDel/Veh:	68.0	63.8	63.8	48.5	45.9	26.2	41.9	40.0	101.3	83.4	28.6	28.6
LOS by Move:	E	E	E	D	D	C	D	D	F	F	C	C
HCM2kAvgQ:	8	27	27	2	18	2	3	6	16	25	10	10

Note: Queue reported is the number of cars per lane.

San Antonio Village Phase III MTA
 SJ21-2068
 Background AM

Level Of Service Computation Report
 2000 HCM Operations (Future Volume Alternative)
 Background AM

Intersection #17: Charleston Road and San Antonio Road

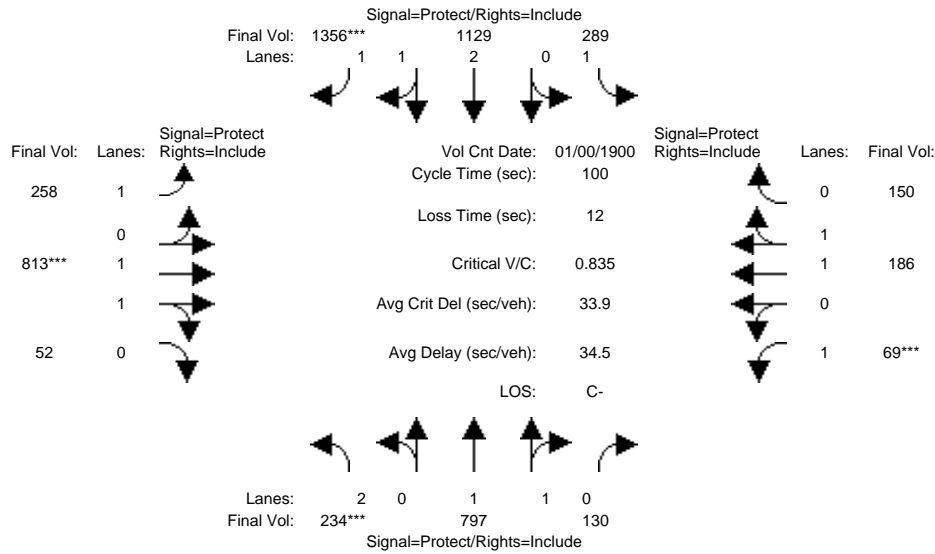

Approach:	North Bound			South Bound			East Bound			West Bound		
	L	T	R	L	T	R	L	T	R	L	T	R
Min. Green:	7	10	10	7	10	10	7	10	10	7	10	10
Y+R:	4.0	4.0	4.0	4.0	4.0	4.0	4.0	4.0	4.0	4.0	4.0	4.0

Volume Module: >> Count Date: 0 Jan 1900 << 12:00:00 AM

Base Vol:	234	734	123	280	1113	1356	258	813	52	57	186	134
Growth Adj:	1.00	1.00	1.00	1.00	1.00	1.00	1.00	1.00	1.00	1.00	1.00	1.00
Initial Bse:	234	734	123	280	1113	1356	258	813	52	57	186	134
Added Vol:	0	63	7	9	16	0	0	0	0	12	0	16
PasserByVol:	0	0	0	0	0	0	0	0	0	0	0	0
Initial Fut:	234	797	130	289	1129	1356	258	813	52	69	186	150
User Adj:	1.00	1.00	1.00	1.00	1.00	1.00	1.00	1.00	1.00	1.00	1.00	1.00
PHF Adj:	1.00	1.00	1.00	1.00	1.00	1.00	1.00	1.00	1.00	1.00	1.00	1.00
PHF Volume:	234	797	130	289	1129	1356	258	813	52	69	186	150
Reduct Vol:	0	0	0	0	0	0	0	0	0	0	0	0
Reduced Vol:	234	797	130	289	1129	1356	258	813	52	69	186	150
PCE Adj:	1.00	1.00	1.00	1.00	1.00	1.00	1.00	1.00	1.00	1.00	1.00	1.00
MLF Adj:	1.00	1.00	1.00	1.00	1.00	1.00	1.00	1.00	1.00	1.00	1.00	1.00
Final Volume:	234	797	130	289	1129	1356	258	813	52	69	186	150

Saturation Flow Module:

Sat/Lane:	1900	1900	1900	1900	1900	1900	1900	1900	1900	1900	1900	1900
Adjustment:	0.83	0.98	0.95	0.92	1.00	0.92	0.92	0.98	0.95	0.92	0.99	0.95
Lanes:	2.00	1.71	0.29	1.00	2.00	2.00	1.00	1.88	0.12	1.00	1.08	0.92
Final Sat.:	3150	3181	519	1750	3800	3500	1750	3477	222	1750	2047	1651

Capacity Analysis Module:

Vol/Sat:	0.07	0.25	0.25	0.17	0.30	0.39	0.15	0.23	0.23	0.04	0.09	0.09
Crit Moves:	****					****		****		****		
Green Time:	8.7	32.4	32.4	21.4	45.1	45.1	20.4	27.2	27.2	7.0	13.8	13.8
Volume/Cap:	0.86	0.77	0.77	0.77	0.66	0.86	0.72	0.86	0.86	0.56	0.66	0.66
Uniform Del:	45.1	30.5	30.5	37.0	21.4	24.6	37.2	34.6	34.6	45.0	40.8	40.8
IncrementDel:	22.8	3.2	3.2	9.6	0.4	2.8	7.1	7.5	7.5	5.9	3.1	3.1
InitQueueDel:	0.0	0.0	0.0	0.0	0.0	0.0	0.0	0.0	0.0	0.0	0.0	0.0
Delay Adj:	1.00	1.00	1.00	1.00	1.00	1.00	1.00	1.00	1.00	1.00	1.00	1.00
Delay/Veh:	67.9	33.7	33.7	46.7	21.9	27.4	44.3	42.1	42.1	50.9	43.9	43.9
User DelAdj:	1.00	1.00	1.00	1.00	1.00	1.00	1.00	1.00	1.00	1.00	1.00	1.00
AdjDel/Veh:	67.9	33.7	33.7	46.7	21.9	27.4	44.3	42.1	42.1	50.9	43.9	43.9
LOS by Move:	E	C-	C-	D	C+	C	D	D	D	D	D	D
HCM2kAvgQ:	5	14	14	11	14	23	10	16	16	3	6	6

Note: Queue reported is the number of cars per lane.

San Antonio Village Phase III MTA
 SJ21-2068
 Background AM

Level Of Service Computation Report
 2000 HCM Operations (Future Volume Alternative)
 Background PP AM

Intersection #17: Charleston Road and San Antonio Road

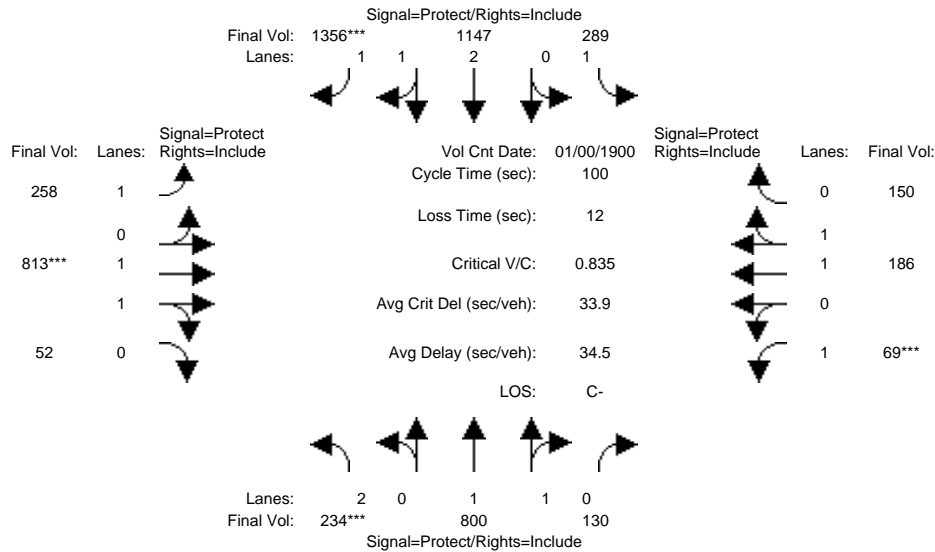

Approach:	North Bound			South Bound			East Bound			West Bound		
	L	T	R	L	T	R	L	T	R	L	T	R
Min. Green:	7	10	10	7	10	10	7	10	10	7	10	10
Y+R:	4.0	4.0	4.0	4.0	4.0	4.0	4.0	4.0	4.0	4.0	4.0	4.0
Volume Module: >> Count Date: 0 Jan 1900 << 12:00:00 AM												
Base Vol:	234	734	123	280	1113	1356	258	813	52	57	186	134
Growth Adj:	1.00	1.00	1.00	1.00	1.00	1.00	1.00	1.00	1.00	1.00	1.00	1.00
Initial Bse:	234	734	123	280	1113	1356	258	813	52	57	186	134
Added Vol:	0	66	7	9	34	0	0	0	0	12	0	16
PasserByVol:	0	0	0	0	0	0	0	0	0	0	0	0
Initial Fut:	234	800	130	289	1147	1356	258	813	52	69	186	150
User Adj:	1.00	1.00	1.00	1.00	1.00	1.00	1.00	1.00	1.00	1.00	1.00	1.00
PHF Adj:	1.00	1.00	1.00	1.00	1.00	1.00	1.00	1.00	1.00	1.00	1.00	1.00
PHF Volume:	234	800	130	289	1147	1356	258	813	52	69	186	150
Reduct Vol:	0	0	0	0	0	0	0	0	0	0	0	0
Reduced Vol:	234	800	130	289	1147	1356	258	813	52	69	186	150
PCE Adj:	1.00	1.00	1.00	1.00	1.00	1.00	1.00	1.00	1.00	1.00	1.00	1.00
MLF Adj:	1.00	1.00	1.00	1.00	1.00	1.00	1.00	1.00	1.00	1.00	1.00	1.00
Final Volume:	234	800	130	289	1147	1356	258	813	52	69	186	150
Saturation Flow Module:												
Sat/Lane:	1900	1900	1900	1900	1900	1900	1900	1900	1900	1900	1900	1900
Adjustment:	0.83	0.98	0.95	0.92	1.00	0.92	0.92	0.98	0.95	0.92	0.99	0.95
Lanes:	2.00	1.71	0.29	1.00	2.00	2.00	1.00	1.88	0.12	1.00	1.08	0.92
Final Sat.:	3150	3182	517	1750	3800	3500	1750	3477	222	1750	2047	1651
Capacity Analysis Module:												
Vol/Sat:	0.07	0.25	0.25	0.17	0.30	0.39	0.15	0.23	0.23	0.04	0.09	0.09
Crit Moves:	****					****		****		****		
Green Time:	8.7	32.5	32.5	21.3	45.1	45.1	20.4	27.2	27.2	7.0	13.8	13.8
Volume/Cap:	0.86	0.77	0.77	0.77	0.67	0.86	0.72	0.86	0.86	0.56	0.66	0.66
Delay/Veh:	67.9	33.7	33.7	46.8	22.0	27.4	44.3	42.1	42.1	50.9	43.9	43.9
User DelAdj:	1.00	1.00	1.00	1.00	1.00	1.00	1.00	1.00	1.00	1.00	1.00	1.00
AdjDel/Veh:	67.9	33.7	33.7	46.8	22.0	27.4	44.3	42.1	42.1	50.9	43.9	43.9
LOS by Move:	E	C-	C-	D	C+	C	D	D	D	D	D	D
HCM2kAvgQ:	5	14	14	11	14	23	10	16	16	3	6	6

Note: Queue reported is the number of cars per lane.

San Antonio Village Phase III MTA
SJ21-2068
Background AM

Level Of Service Computation Report
2000 HCM Unsignalized (Future Volume Alternative)
Background AM

Intersection #18: Project Driveway and San Antonio Road

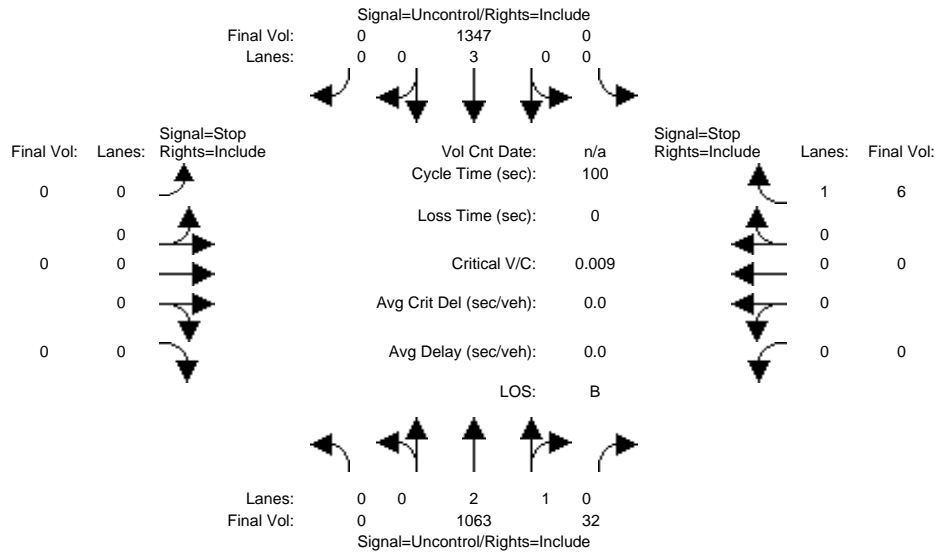

Approach:	North Bound			South Bound			East Bound			West Bound		
Movement:	L	T	R	L	T	R	L	T	R	L	T	R
Volume Module:												
Base Vol:	0	1014	32	0	1268	0	0	0	0	0	0	6
Growth Adj:	1.00	1.00	1.00	1.00	1.00	1.00	1.00	1.00	1.00	1.00	1.00	1.00
Initial Bse:	0	1014	32	0	1268	0	0	0	0	0	0	6
Added Vol:	0	49	0	0	79	0	0	0	0	0	0	0
PasserByVol:	0	0	0	0	0	0	0	0	0	0	0	0
Initial Fut:	0	1063	32	0	1347	0	0	0	0	0	0	6
User Adj:	1.00	1.00	1.00	1.00	1.00	1.00	1.00	1.00	1.00	1.00	1.00	1.00
PHF Adj:	1.00	1.00	1.00	1.00	1.00	1.00	1.00	1.00	1.00	1.00	1.00	1.00
PHF Volume:	0	1063	32	0	1347	0	0	0	0	0	0	6
Reduct Vol:	0	0	0	0	0	0	0	0	0	0	0	0
FinalVolume:	0	1063	32	0	1347	0	0	0	0	0	0	6
Critical Gap Module:												
Critical Gp:	xxxxx	xxxx	xxxxx	xxxxx	xxxx	xxxxx	xxxxx	xxxx	xxxxx	xxxxx	xxxx	6.9
FollowUpTim:	xxxxxx	xxxx	xxxxxx	xxxxxx	xxxx	xxxxxx	xxxxxx	xxxx	xxxxxx	xxxxxx	xxxx	3.3
Capacity Module:												
Cnflct Vol:	xxxx	xxxx	xxxxx	xxxx	xxxx	xxxxx	xxxx	xxxx	xxxxx	xxxx	xxxx	370
Potent Cap.:	xxxx	xxxx	xxxxx	xxxx	xxxx	xxxxx	xxxx	xxxx	xxxxx	xxxx	xxxx	633
Move Cap.:	xxxx	xxxx	xxxxx	xxxx	xxxx	xxxxx	xxxx	xxxx	xxxxx	xxxx	xxxx	633
Volume/Cap:	xxxx	xxxx	xxxx	xxxx	xxxx	xxxx	xxxx	xxxx	xxxx	xxxx	xxxx	0.01
Level Of Service Module:												
2Way95thQ:	xxxx	xxxx	xxxxx	xxxx	xxxx	xxxxx	xxxx	xxxx	xxxxx	xxxx	xxxx	0.0
Control Del:	xxxxxx	xxxx	xxxxxx	xxxxxx	xxxx	xxxxxx	xxxxxx	xxxx	xxxxxx	xxxxxx	xxxx	10.7
LOS by Move:	*	*	*	*	*	*	*	*	*	*	*	B
Movement:	LT	LTR	RT	LT	LTR	RT	LT	LTR	RT	LT	LTR	RT
Shared Cap.:	xxxx	xxxx	xxxxx	xxxx	xxxx	xxxxx	xxxx	xxxx	xxxxx	xxxx	xxxx	xxxxx
SharedQueue:	xxxxxx	xxxx	xxxxxx	xxxxxx	xxxx	xxxxxx	xxxxxx	xxxx	xxxxxx	xxxxxx	xxxx	xxxxxx
Shrd ConDel:	xxxxxx	xxxx	xxxxxx	xxxxxx	xxxx	xxxxxx	xxxxxx	xxxx	xxxxxx	xxxxxx	xxxx	xxxxxx
Shared LOS:	*	*	*	*	*	*	*	*	*	*	*	*
ApproachDel:	xxxxxxx			xxxxxxx			xxxxxxx			10.7		
ApproachLOS:	*			*			*			B		

Note: Queue reported is the number of cars per lane.

San Antonio Village Phase III MTA
SJ21-2068
Background AM

Level Of Service Computation Report
2000 HCM Unsignalized (Future Volume Alternative)
Background PP AM

Intersection #18: Project Driveway and San Antonio Road

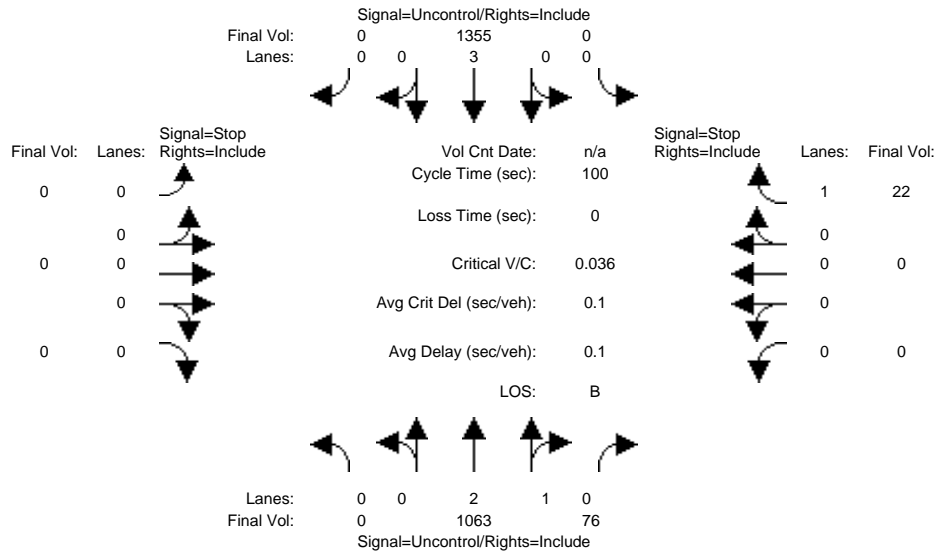

Approach:	North Bound			South Bound			East Bound			West Bound		
Movement:	L	T	R	L	T	R	L	T	R	L	T	R
Volume Module:												
Base Vol:	0	1014	32	0	1268	0	0	0	0	0	0	6
Growth Adj:	1.00	1.00	1.00	1.00	1.00	1.00	1.00	1.00	1.00	1.00	1.00	1.00
Initial Bse:	0	1014	32	0	1268	0	0	0	0	0	0	6
Added Vol:	0	49	44	0	87	0	0	0	0	0	0	16
PasserByVol:	0	0	0	0	0	0	0	0	0	0	0	0
Initial Fut:	0	1063	76	0	1355	0	0	0	0	0	0	22
User Adj:	1.00	1.00	1.00	1.00	1.00	1.00	1.00	1.00	1.00	1.00	1.00	1.00
PHF Adj:	1.00	1.00	1.00	1.00	1.00	1.00	1.00	1.00	1.00	1.00	1.00	1.00
PHF Volume:	0	1063	76	0	1355	0	0	0	0	0	0	22
Reduct Vol:	0	0	0	0	0	0	0	0	0	0	0	0
FinalVolume:	0	1063	76	0	1355	0	0	0	0	0	0	22
Critical Gap Module:												
Critical Gp:	xxxxx	xxxx	xxxxx	xxxxx	xxxx	xxxxx	xxxxx	xxxx	xxxxx	xxxxx	xxxx	6.9
FollowUpTim:	xxxxx	xxxx	xxxxx	xxxxx	xxxx	xxxxx	xxxxx	xxxx	xxxxx	xxxxx	xxxx	3.3
Capacity Module:												
Cnflct Vol:	xxxx	xxxx	xxxxx	xxxx	xxxx	xxxxx	xxxx	xxxx	xxxxx	xxxx	xxxx	392
Potent Cap.:	xxxx	xxxx	xxxxx	xxxx	xxxx	xxxxx	xxxx	xxxx	xxxxx	xxxx	xxxx	612
Move Cap.:	xxxx	xxxx	xxxxx	xxxx	xxxx	xxxxx	xxxx	xxxx	xxxxx	xxxx	xxxx	612
Volume/Cap:	xxxx	xxxx	xxxx	xxxx	xxxx	xxxx	xxxx	xxxx	xxxx	xxxx	xxxx	0.04
Level Of Service Module:												
2Way95thQ:	xxxx	xxxx	xxxxx	xxxx	xxxx	xxxxx	xxxx	xxxx	xxxxx	xxxx	xxxx	0.1
Control Del:	xxxxx	xxxx	xxxxx	xxxxx	xxxx	xxxxx	xxxxx	xxxx	xxxxx	xxxxx	xxxx	11.1
LOS by Move:	*	*	*	*	*	*	*	*	*	*	*	B
Movement:	LT	LTR	RT	LT	LTR	RT	LT	LTR	RT	LT	LTR	RT
Shared Cap.:	xxxx	xxxx	xxxxx	xxxx	xxxx	xxxxx	xxxx	xxxx	xxxxx	xxxx	xxxx	xxxxx
SharedQueue:	xxxxx	xxxx	xxxxx	xxxxx	xxxx	xxxxx	xxxxx	xxxx	xxxxx	xxxxx	xxxx	xxxxx
Shrd ConDel:	xxxxx	xxxx	xxxxx	xxxxx	xxxx	xxxxx	xxxxx	xxxx	xxxxx	xxxxx	xxxx	xxxxx
Shared LOS:	*	*	*	*	*	*	*	*	*	*	*	*
ApproachDel:	xxxxxxx			xxxxxxx			xxxxxxx			11.1		
ApproachLOS:	*			*			*			B		

Note: Queue reported is the number of cars per lane.

San Antonio Village Phase III MTA
 SJ21-2068
 Background AM

Level Of Service Computation Report
 2000 HCM Unsignalized (Future Volume Alternative)
 Background AM

Intersection #19: Project Driveway and California Street

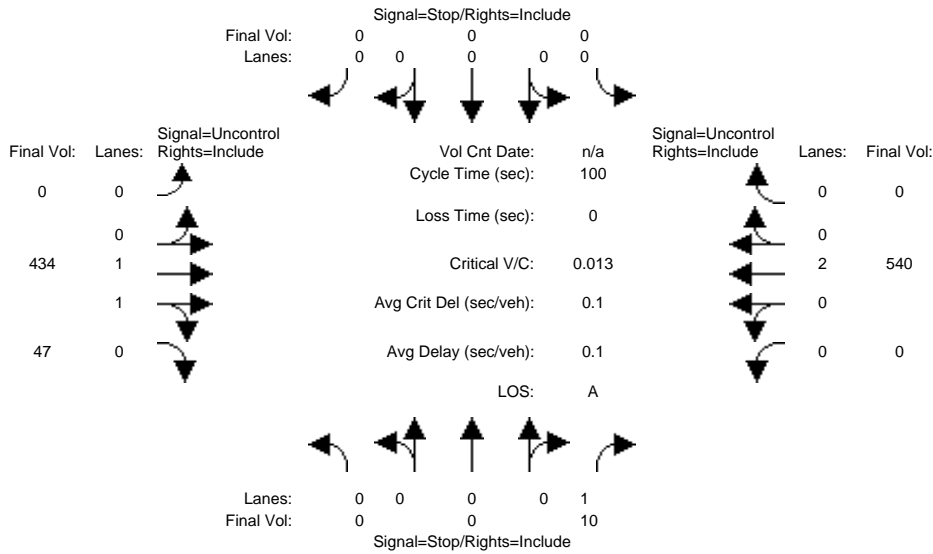

Approach:	North Bound			South Bound			East Bound			West Bound		
Movement:	L	T	R	L	T	R	L	T	R	L	T	R
Volume Module:												
Base Vol:	0	0	10	0	0	0	0	429	47	0	539	0
Growth Adj:	1.00	1.00	1.00	1.00	1.00	1.00	1.00	1.00	1.00	1.00	1.00	1.00
Initial Bse:	0	0	10	0	0	0	0	429	47	0	539	0
Added Vol:	0	0	0	0	0	0	0	5	0	0	1	0
PasserByVol:	0	0	0	0	0	0	0	0	0	0	0	0
Initial Fut:	0	0	10	0	0	0	0	434	47	0	540	0
User Adj:	1.00	1.00	1.00	1.00	1.00	1.00	1.00	1.00	1.00	1.00	1.00	1.00
PHF Adj:	1.00	1.00	1.00	1.00	1.00	1.00	1.00	1.00	1.00	1.00	1.00	1.00
PHF Volume:	0	0	10	0	0	0	0	434	47	0	540	0
Reduct Vol:	0	0	0	0	0	0	0	0	0	0	0	0
FinalVolume:	0	0	10	0	0	0	0	434	47	0	540	0
Critical Gap Module:												
Critical Gp:	xxxxx	xxxx	6.9	xxxxx	xxxx	xxxxx	xxxxx	xxxx	xxxxx	xxxxx	xxxx	xxxxx
FollowUpTim:	xxxxx	xxxx	3.3	xxxxx	xxxx	xxxxx	xxxxx	xxxx	xxxxx	xxxxx	xxxx	xxxxx
Capacity Module:												
Cnflct Vol:	xxxx	xxxx	241	xxxx	xxxx	xxxxx	xxxx	xxxx	xxxxx	xxxx	xxxx	xxxxx
Potent Cap.:	xxxx	xxxx	767	xxxx	xxxx	xxxxx	xxxx	xxxx	xxxxx	xxxx	xxxx	xxxxx
Move Cap.:	xxxx	xxxx	767	xxxx	xxxx	xxxxx	xxxx	xxxx	xxxxx	xxxx	xxxx	xxxxx
Volume/Cap:	xxxx	xxxx	0.01	xxxx	xxxx	xxxx	xxxx	xxxx	xxxx	xxxx	xxxx	xxxx
Level Of Service Module:												
2Way95thQ:	xxxx	xxxx	0.0	xxxx	xxxx	xxxxx	xxxx	xxxx	xxxxx	xxxx	xxxx	xxxxx
Control Del:	xxxxx	xxxx	9.8	xxxxx	xxxx	xxxxx	xxxxx	xxxx	xxxxx	xxxxx	xxxx	xxxxx
LOS by Move:	*	*	A	*	*	*	*	*	*	*	*	*
Movement:	LT	LTR	RT	LT	LTR	RT	LT	LTR	RT	LT	LTR	RT
Shared Cap.:	xxxx	xxxx	xxxxx	xxxx	xxxx	xxxxx	xxxx	xxxx	xxxxx	xxxx	xxxx	xxxxx
SharedQueue:	xxxxx	xxxx	xxxxx	xxxxx	xxxx	xxxxx	xxxxx	xxxx	xxxxx	xxxxx	xxxx	xxxxx
Shrd ConDel:	xxxxx	xxxx	xxxxx	xxxxx	xxxx	xxxxx	xxxxx	xxxx	xxxxx	xxxxx	xxxx	xxxxx
Shared LOS:	*	*	*	*	*	*	*	*	*	*	*	*
ApproachDel:	9.8			xxxxxxx			xxxxxxx			xxxxxxx		
ApproachLOS:	A			*			*			*		

Note: Queue reported is the number of cars per lane.

San Antonio Village Phase III MTA
 SJ21-2068
 Background AM

Level Of Service Computation Report
 2000 HCM Unsignalized (Future Volume Alternative)
 Background PP AM

Intersection #19: Project Driveway and California Street

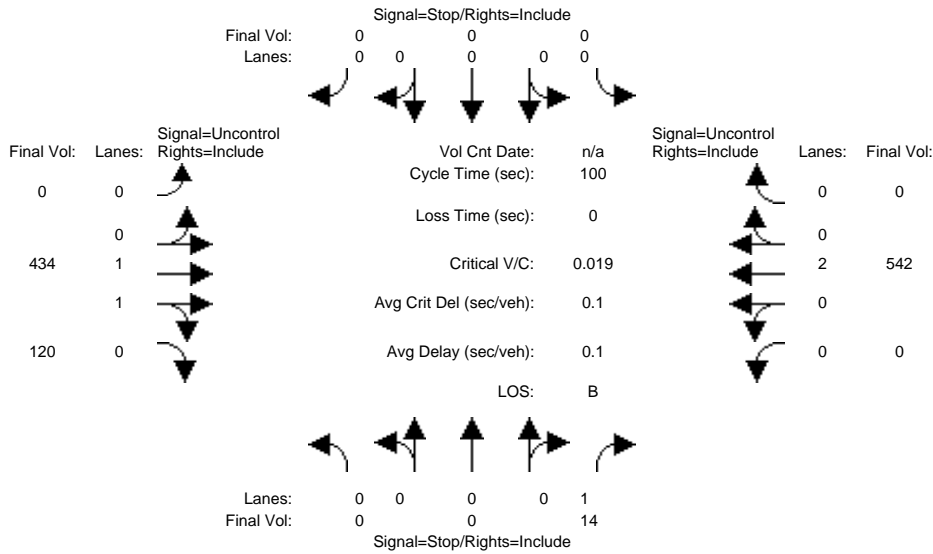

Approach:	North Bound			South Bound			East Bound			West Bound		
Movement:	L	T	R	L	T	R	L	T	R	L	T	R
Volume Module:												
Base Vol:	0	0	10	0	0	0	0	429	47	0	539	0
Growth Adj:	1.00	1.00	1.00	1.00	1.00	1.00	1.00	1.00	1.00	1.00	1.00	1.00
Initial Bse:	0	0	10	0	0	0	0	429	47	0	539	0
Added Vol:	0	0	4	0	0	0	0	5	73	0	3	0
PasserByVol:	0	0	0	0	0	0	0	0	0	0	0	0
Initial Fut:	0	0	14	0	0	0	0	434	120	0	542	0
User Adj:	1.00	1.00	1.00	1.00	1.00	1.00	1.00	1.00	1.00	1.00	1.00	1.00
PHF Adj:	1.00	1.00	1.00	1.00	1.00	1.00	1.00	1.00	1.00	1.00	1.00	1.00
PHF Volume:	0	0	14	0	0	0	0	434	120	0	542	0
Reduct Vol:	0	0	0	0	0	0	0	0	0	0	0	0
FinalVolume:	0	0	14	0	0	0	0	434	120	0	542	0
Critical Gap Module:												
Critical Gp:	xxxxx	xxxx	6.9	xxxxx	xxxx	xxxxx	xxxxx	xxxx	xxxxx	xxxxx	xxxx	xxxxx
FollowUpTim:	xxxxx	xxxx	3.3	xxxxx	xxxx	xxxxx	xxxxx	xxxx	xxxxx	xxxxx	xxxx	xxxxx
Capacity Module:												
Cnflct Vol:	xxxx	xxxx	277	xxxx	xxxx	xxxxx	xxxx	xxxx	xxxxx	xxxx	xxxx	xxxxx
Potent Cap.:	xxxx	xxxx	726	xxxx	xxxx	xxxxx	xxxx	xxxx	xxxxx	xxxx	xxxx	xxxxx
Move Cap.:	xxxx	xxxx	726	xxxx	xxxx	xxxxx	xxxx	xxxx	xxxxx	xxxx	xxxx	xxxxx
Volume/Cap:	xxxx	xxxx	0.02	xxxx	xxxx	xxxx	xxxx	xxxx	xxxx	xxxx	xxxx	xxxx
Level Of Service Module:												
2Way95thQ:	xxxx	xxxx	0.1	xxxx	xxxx	xxxxx	xxxx	xxxx	xxxxx	xxxx	xxxx	xxxxx
Control Del:	xxxxx	xxxx	10.1	xxxxx	xxxx	xxxxx	xxxxx	xxxx	xxxxx	xxxxx	xxxx	xxxxx
LOS by Move:	*	*	B	*	*	*	*	*	*	*	*	*
Movement:	LT	LTR	RT	LT	LTR	RT	LT	LTR	RT	LT	LTR	RT
Shared Cap.:	xxxx	xxxx	xxxxx	xxxx	xxxx	xxxxx	xxxx	xxxx	xxxxx	xxxx	xxxx	xxxxx
SharedQueue:	xxxxx	xxxx	xxxxx	xxxxx	xxxx	xxxxx	xxxxx	xxxx	xxxxx	xxxxx	xxxx	xxxxx
Shrd ConDel:	xxxxx	xxxx	xxxxx	xxxxx	xxxx	xxxxx	xxxxx	xxxx	xxxxx	xxxxx	xxxx	xxxxx
Shared LOS:	*	*	*	*	*	*	*	*	*	*	*	*
ApproachDel:	10.1			xxxxxxx			xxxxxxx			xxxxxxx		
ApproachLOS:	B			*			*			*		

Note: Queue reported is the number of cars per lane.

San Antonio Village Phase III MTA
 SJ21-2068
 Background PM

Level Of Service Computation Report
 2000 HCM Operations (Future Volume Alternative)
 Background PM

Intersection #1: El Camino Real and Arastradero Road-Charleston Road

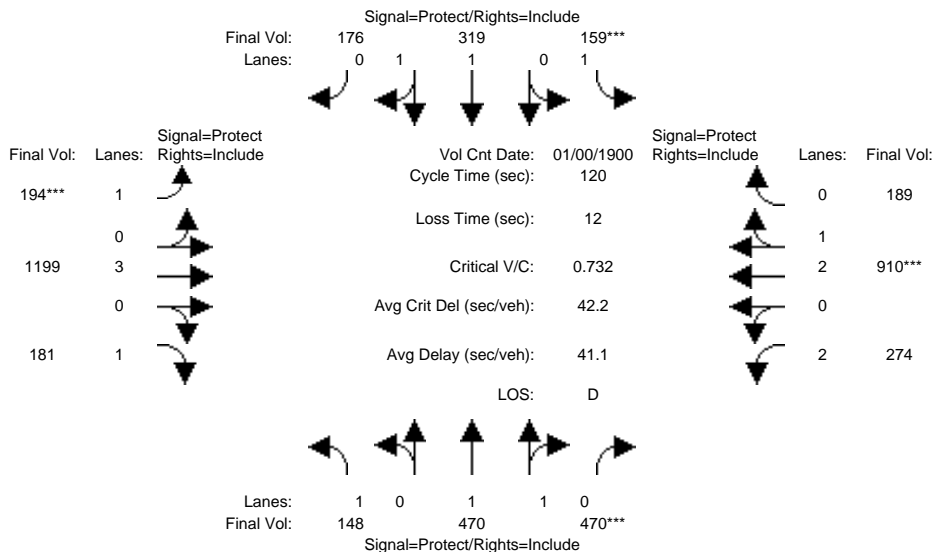

Approach:	North Bound			South Bound			East Bound			West Bound		
	L	T	R	L	T	R	L	T	R	L	T	R
Min. Green:	7	10	10	7	10	10	7	10	10	7	10	10
Y+R:	4.0	4.0	4.0	4.0	4.0	4.0	4.0	4.0	4.0	4.0	4.0	4.0

Volume Module:	>>	Count	Date:	0 Jan 1900	<<	12:00:00 AM						
Base Vol:	148	470	461	159	319	176	194	1154	181	272	883	189
Growth Adj:	1.00	1.00	1.00	1.00	1.00	1.00	1.00	1.00	1.00	1.00	1.00	1.00
Initial Bse:	148	470	461	159	319	176	194	1154	181	272	883	189
Added Vol:	0	0	9	0	0	0	0	45	0	2	27	0
PasserByVol:	0	0	0	0	0	0	0	0	0	0	0	0
Initial Fut:	148	470	470	159	319	176	194	1199	181	274	910	189
User Adj:	1.00	1.00	1.00	1.00	1.00	1.00	1.00	1.00	1.00	1.00	1.00	1.00
PHF Adj:	1.00	1.00	1.00	1.00	1.00	1.00	1.00	1.00	1.00	1.00	1.00	1.00
PHF Volume:	148	470	470	159	319	176	194	1199	181	274	910	189
Reduct Vol:	0	0	0	0	0	0	0	0	0	0	0	0
Reduced Vol:	148	470	470	159	319	176	194	1199	181	274	910	189
PCE Adj:	1.00	1.00	1.00	1.00	1.00	1.00	1.00	1.00	1.00	1.00	1.00	1.00
MLF Adj:	1.00	1.00	1.00	1.00	1.00	1.00	1.00	1.00	1.00	1.00	1.00	1.00
Final Volume:	148	470	470	159	319	176	194	1199	181	274	910	189

Saturation Flow Module:												
Sat/Lane:	1900	1900	1900	1900	1900	1900	1900	1900	1900	1900	1900	1900
Adjustment:	0.92	1.00	0.95	0.92	0.99	0.95	0.92	1.00	0.92	0.83	0.99	0.95
Lanes:	1.00	1.00	1.00	1.00	1.27	0.73	1.00	3.00	1.00	2.00	2.47	0.53
Final Sat.:	1750	1900	1800	1750	2383	1315	1750	5700	1750	3150	4636	963

Capacity Analysis Module:												
Vol/Sat:	0.08	0.25	0.26	0.09	0.13	0.13	0.11	0.21	0.10	0.09	0.20	0.20
Crit Moves:			****	****			****				****	
Green Time:	22.3	42.8	42.8	14.9	35.3	35.3	18.2	35.6	35.6	14.7	32.2	32.2
Volume/Cap:	0.45	0.69	0.73	0.73	0.45	0.45	0.73	0.71	0.35	0.71	0.73	0.73
Uniform Del:	43.4	33.0	33.6	50.6	34.5	34.5	48.6	37.6	33.1	50.6	40.0	40.0
IncrementDel:	1.0	1.6	2.2	12.1	0.3	0.3	10.0	1.4	0.4	6.0	1.9	1.9
InitQueueDel:	0.0	0.0	0.0	0.0	0.0	0.0	0.0	0.0	0.0	0.0	0.0	0.0
Delay Adj:	1.00	1.00	1.00	1.00	1.00	1.00	1.00	1.00	1.00	1.00	1.00	1.00
Delay/Veh:	44.4	34.6	35.8	62.7	34.8	34.8	58.6	39.0	33.5	56.6	41.9	41.9
User DelAdj:	1.00	1.00	1.00	1.00	1.00	1.00	1.00	1.00	1.00	1.00	1.00	1.00
AdjDel/Veh:	44.4	34.6	35.8	62.7	34.8	34.8	58.6	39.0	33.5	56.6	41.9	41.9
LOS by Move:	D	C-	D+	E	C-	C-	E+	D+	C-	E+	D	D
HCM2kAvgQ:	6	15	17	8	8	8	9	14	6	7	14	14

Note: Queue reported is the number of cars per lane.

San Antonio Village Phase III MTA
 SJ21-2068
 Background PM

Level Of Service Computation Report
 2000 HCM Operations (Future Volume Alternative)
 Background PP PM

Intersection #1: El Camino Real and Arastradero Road-Charleston Road

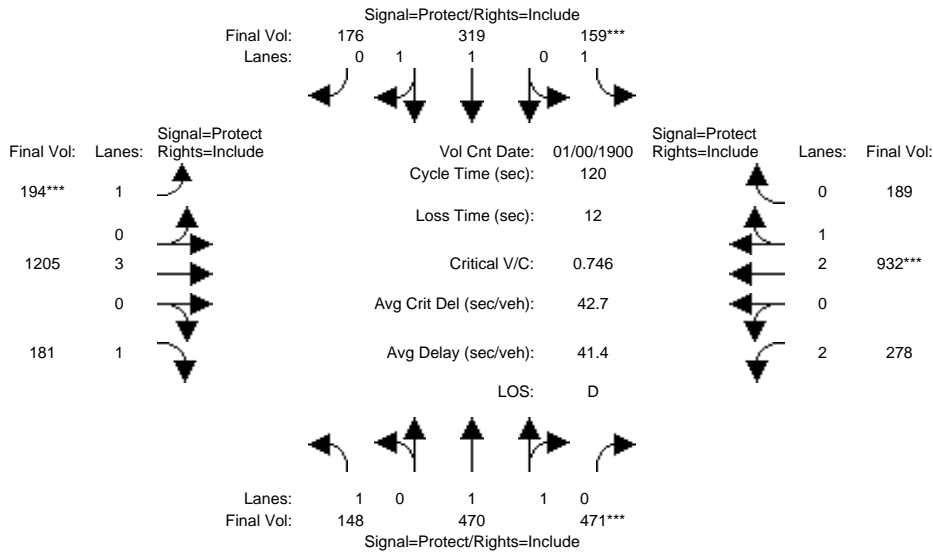

Approach:	North Bound			South Bound			East Bound			West Bound		
	L	T	R	L	T	R	L	T	R	L	T	R
Min. Green:	7	10	10	7	10	10	7	10	10	7	10	10
Y+R:	4.0	4.0	4.0	4.0	4.0	4.0	4.0	4.0	4.0	4.0	4.0	4.0

Volume Module:	>> Count Date: 0 Jan 1900 << 12:00:00 AM											
Base Vol:	148	470	461	159	319	176	194	1154	181	272	883	189
Growth Adj:	1.00	1.00	1.00	1.00	1.00	1.00	1.00	1.00	1.00	1.00	1.00	1.00
Initial Bse:	148	470	461	159	319	176	194	1154	181	272	883	189
Added Vol:	0	0	10	0	0	0	0	51	0	6	49	0
PasserByVol:	0	0	0	0	0	0	0	0	0	0	0	0
Initial Fut:	148	470	471	159	319	176	194	1205	181	278	932	189
User Adj:	1.00	1.00	1.00	1.00	1.00	1.00	1.00	1.00	1.00	1.00	1.00	1.00
PHF Adj:	1.00	1.00	1.00	1.00	1.00	1.00	1.00	1.00	1.00	1.00	1.00	1.00
PHF Volume:	148	470	471	159	319	176	194	1205	181	278	932	189
Reduct Vol:	0	0	0	0	0	0	0	0	0	0	0	0
Reduced Vol:	148	470	471	159	319	176	194	1205	181	278	932	189
PCE Adj:	1.00	1.00	1.00	1.00	1.00	1.00	1.00	1.00	1.00	1.00	1.00	1.00
MLF Adj:	1.00	1.00	1.00	1.00	1.00	1.00	1.00	1.00	1.00	1.00	1.00	1.00
Final Volume:	148	470	471	159	319	176	194	1205	181	278	932	189

Saturation Flow Module:												
Sat/Lane:	1900	1900	1900	1900	1900	1900	1900	1900	1900	1900	1900	1900
Adjustment:	0.92	1.00	0.92	0.92	0.99	0.95	0.92	1.00	0.92	0.83	0.99	0.95
Lanes:	1.00	1.00	1.00	1.00	1.27	0.73	1.00	3.00	1.00	2.00	2.48	0.52
Final Sat.:	1750	1900	1750	1750	2383	1315	1750	5700	1750	3150	4655	944

Capacity Analysis Module:												
Vol/Sat:	0.08	0.25	0.27	0.09	0.13	0.13	0.11	0.21	0.10	0.09	0.20	0.20
Crit Moves:			****	****			****			****		
Green Time:	22.4	43.3	43.3	14.6	35.5	35.5	17.8	35.3	35.3	14.7	32.2	32.2
Volume/Cap:	0.45	0.69	0.75	0.75	0.45	0.45	0.75	0.72	0.35	0.72	0.75	0.75
Delay/Veh:	44.3	34.0	36.0	64.3	34.6	34.6	60.1	39.4	33.7	57.0	42.2	42.2
User DelAdj:	1.00	1.00	1.00	1.00	1.00	1.00	1.00	1.00	1.00	1.00	1.00	1.00
AdjDel/Veh:	44.3	34.0	36.0	64.3	34.6	34.6	60.1	39.4	33.7	57.0	42.2	42.2
LOS by Move:	D	C-	D+	E	C-	C-	E	D	C-	E+	D	D
HCM2kAvgQ:	6	15	18	8	8	8	9	14	6	7	14	14

Note: Queue reported is the number of cars per lane.

San Antonio Village Phase III MTA
 SJ21-2068
 Background PM

Level Of Service Computation Report
 2000 HCM Operations (Future Volume Alternative)
 Background PM

Intersection #2: El Camino Real and Del Medio Avenue

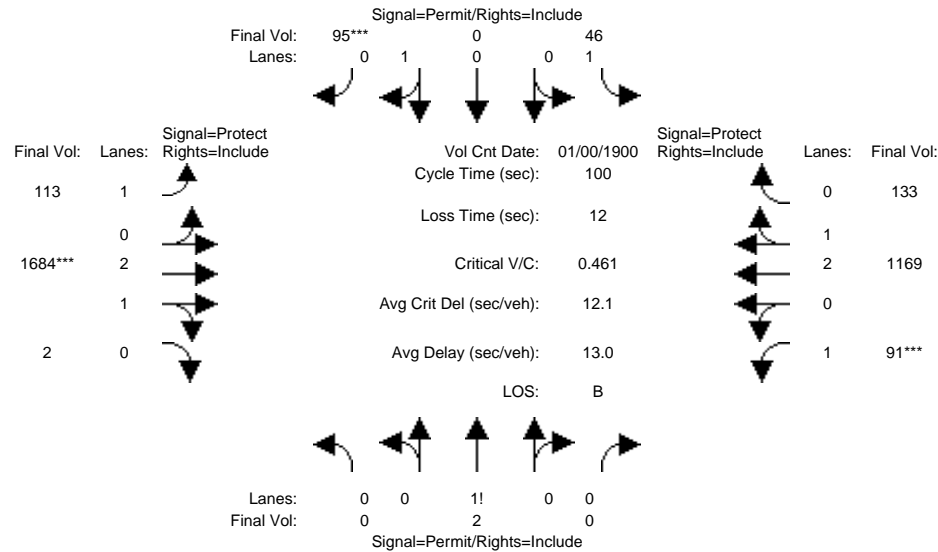

Approach:	North Bound			South Bound			East Bound			West Bound		
	L	T	R	L	T	R	L	T	R	L	T	R
Min. Green:	10	10	10	10	10	10	7	10	10	7	10	10
Y+R:	4.0	4.0	4.0	4.0	4.0	4.0	4.0	4.0	4.0	4.0	4.0	4.0
Volume Module: >> Count Date: 0 Jan 1900 << 12:00:00 AM												
Base Vol:	0	2	0	46	0	95	113	1630	2	91	1139	133
Growth Adj:	1.00	1.00	1.00	1.00	1.00	1.00	1.00	1.00	1.00	1.00	1.00	1.00
Initial Bse:	0	2	0	46	0	95	113	1630	2	91	1139	133
Added Vol:	0	0	0	0	0	0	0	54	0	0	30	0
PasserByVol:	0	0	0	0	0	0	0	0	0	0	0	0
Initial Fut:	0	2	0	46	0	95	113	1684	2	91	1169	133
User Adj:	1.00	1.00	1.00	1.00	1.00	1.00	1.00	1.00	1.00	1.00	1.00	1.00
PHF Adj:	1.00	1.00	1.00	1.00	1.00	1.00	1.00	1.00	1.00	1.00	1.00	1.00
PHF Volume:	0	2	0	46	0	95	113	1684	2	91	1169	133
Reduct Vol:	0	0	0	0	0	0	0	0	0	0	0	0
Reduced Vol:	0	2	0	46	0	95	113	1684	2	91	1169	133
PCE Adj:	1.00	1.00	1.00	1.00	1.00	1.00	1.00	1.00	1.00	1.00	1.00	1.00
MLF Adj:	1.00	1.00	1.00	1.00	1.00	1.00	1.00	1.00	1.00	1.00	1.00	1.00
FinalVolume:	0	2	0	46	0	95	113	1684	2	91	1169	133
Saturation Flow Module:												
Sat/Lane:	1900	1900	1900	1900	1900	1900	1900	1900	1900	1900	1900	1900
Adjustment:	0.92	1.00	0.92	0.92	1.00	0.95	0.92	0.98	0.95	0.92	0.99	0.95
Lanes:	0.00	1.00	0.00	1.00	0.00	1.00	1.00	2.99	0.01	1.00	2.68	0.32
Final Sat.:	0	1900	0	1750	0	1800	1750	5593	7	1750	5027	572
Capacity Analysis Module:												
Vol/Sat:	0.00	0.00	0.00	0.03	0.00	0.05	0.06	0.30	0.30	0.05	0.23	0.23
Crit Moves:				****			****			****		
Green Time:	0.0	11.4	0.0	11.4	0.0	11.4	17.7	65.3	65.3	11.3	58.8	58.8
Volume/Cap:	0.00	0.01	0.00	0.23	0.00	0.46	0.36	0.46	0.46	0.46	0.40	0.40
Uniform Del:	0.0	39.3	0.0	40.3	0.0	41.4	36.2	8.6	8.6	41.5	11.0	11.0
IncrcmntDel:	0.0	0.0	0.0	0.6	0.0	1.6	0.7	0.1	0.1	1.7	0.1	0.1
InitQueuDel:	0.0	0.0	0.0	0.0	0.0	0.0	0.0	0.0	0.0	0.0	0.0	0.0
Delay Adj:	0.00	1.00	0.00	1.00	0.00	1.00	1.00	1.00	1.00	1.00	1.00	1.00
Delay/Veh:	0.0	39.3	0.0	40.9	0.0	43.0	36.9	8.7	8.7	43.2	11.1	11.1
User DelAdj:	1.00	1.00	1.00	1.00	1.00	1.00	1.00	1.00	1.00	1.00	1.00	1.00
AdjDel/Veh:	0.0	39.3	0.0	40.9	0.0	43.0	36.9	8.7	8.7	43.2	11.1	11.1
LOS by Move:	A	D	A	D	A	D	D+	A	A	D	B+	B+
HCM2kAvgQ:	0	0	0	2	0	3	4	9	9	3	7	7

Note: Queue reported is the number of cars per lane.

San Antonio Village Phase III MTA
 SJ21-2068
 Background PM

Level Of Service Computation Report
 2000 HCM Operations (Future Volume Alternative)
 Background PP PM

Intersection #2: El Camino Real and Del Medio Avenue

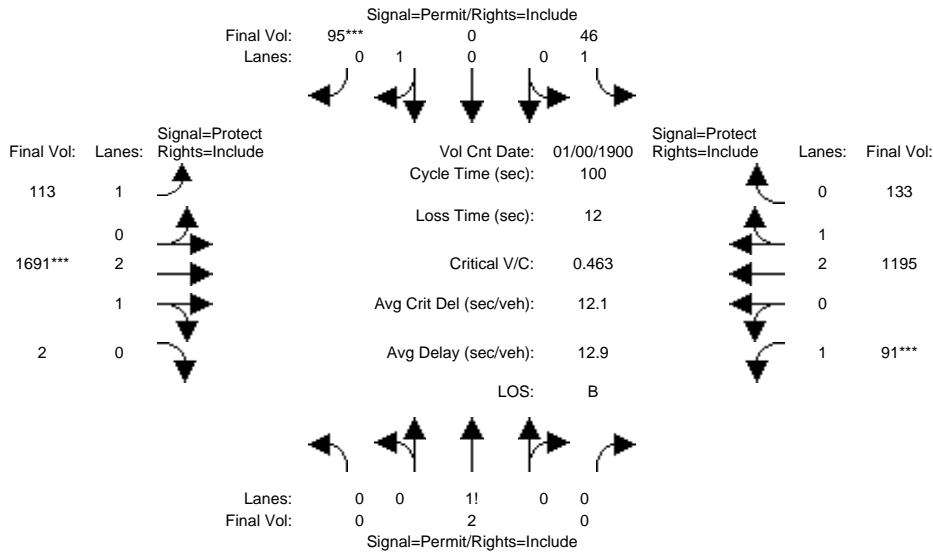

Approach:	North Bound			South Bound			East Bound			West Bound		
	L	T	R	L	T	R	L	T	R	L	T	R
Min. Green:	10	10	10	10	10	10	7	10	10	7	10	10
Y+R:	4.0	4.0	4.0	4.0	4.0	4.0	4.0	4.0	4.0	4.0	4.0	4.0
Volume Module: >> Count Date: 0 Jan 1900 << 12:00:00 AM												
Base Vol:	0	2	0	46	0	95	113	1630	2	91	1139	133
Growth Adj:	1.00	1.00	1.00	1.00	1.00	1.00	1.00	1.00	1.00	1.00	1.00	1.00
Initial Bse:	0	2	0	46	0	95	113	1630	2	91	1139	133
Added Vol:	0	0	0	0	0	0	0	61	0	0	56	0
PasserByVol:	0	0	0	0	0	0	0	0	0	0	0	0
Initial Fut:	0	2	0	46	0	95	113	1691	2	91	1195	133
User Adj:	1.00	1.00	1.00	1.00	1.00	1.00	1.00	1.00	1.00	1.00	1.00	1.00
PHF Adj:	1.00	1.00	1.00	1.00	1.00	1.00	1.00	1.00	1.00	1.00	1.00	1.00
PHF Volume:	0	2	0	46	0	95	113	1691	2	91	1195	133
Reduct Vol:	0	0	0	0	0	0	0	0	0	0	0	0
Reduced Vol:	0	2	0	46	0	95	113	1691	2	91	1195	133
PCE Adj:	1.00	1.00	1.00	1.00	1.00	1.00	1.00	1.00	1.00	1.00	1.00	1.00
MLF Adj:	1.00	1.00	1.00	1.00	1.00	1.00	1.00	1.00	1.00	1.00	1.00	1.00
FinalVolume:	0	2	0	46	0	95	113	1691	2	91	1195	133
Saturation Flow Module:												
Sat/Lane:	1900	1900	1900	1900	1900	1900	1900	1900	1900	1900	1900	1900
Adjustment:	0.92	1.00	0.92	0.92	1.00	0.95	0.92	0.98	0.95	0.92	0.99	0.95
Lanes:	0.00	1.00	0.00	1.00	0.00	1.00	1.00	2.99	0.01	1.00	2.69	0.31
Final Sat.:	0	1900	0	1750	0	1800	1750	5593	7	1750	5038	561
Capacity Analysis Module:												
Vol/Sat:	0.00	0.00	0.00	0.03	0.00	0.05	0.06	0.30	0.30	0.05	0.24	0.24
Crit Moves:				****			****			****		
Green Time:	0.0	11.4	0.0	11.4	0.0	11.4	17.5	65.4	65.4	11.2	59.1	59.1
Volume/Cap:	0.00	0.01	0.00	0.23	0.00	0.46	0.37	0.46	0.46	0.46	0.40	0.40
Delay/Veh:	0.0	39.3	0.0	40.9	0.0	43.1	37.2	8.7	8.7	43.3	11.0	11.0
User DelAdj:	1.00	1.00	1.00	1.00	1.00	1.00	1.00	1.00	1.00	1.00	1.00	1.00
AdjDel/Veh:	0.0	39.3	0.0	40.9	0.0	43.1	37.2	8.7	8.7	43.3	11.0	11.0
LOS by Move:	A	D	A	D	A	D	D+	A	A	D	B+	B+
HCM2kAvgQ:	0	0	0	2	0	3	4	9	9	3	7	7

Note: Queue reported is the number of cars per lane.

San Antonio Village Phase III MTA
 SJ21-2068
 Background PM

Level Of Service Computation Report
 2000 HCM Operations (Future Volume Alternative)
 Background PM

Intersection #3: El Camino Real and San Antonio Road

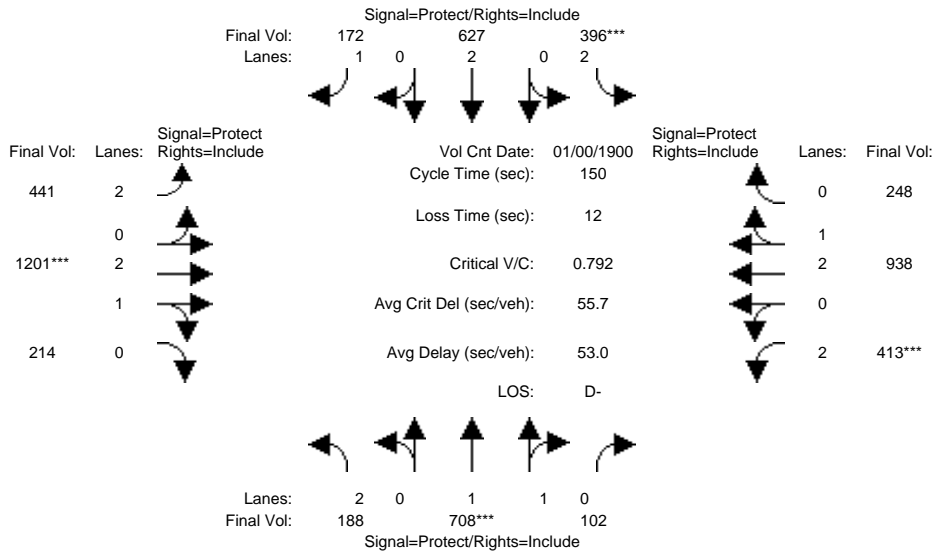

Approach:	North Bound			South Bound			East Bound			West Bound		
	L	T	R	L	T	R	L	T	R	L	T	R
Min. Green:	10	30	0	10	30	0	10	28	0	10	28	0
Y+R:	4.0	4.0	4.0	4.0	4.0	4.0	4.0	4.0	4.0	4.0	4.0	4.0
Volume Module: >> Count Date: 0 Jan 1900 << 12:00:00 AM												
Base Vol:	179	687	88	364	613	166	420	1179	203	402	923	222
Growth Adj:	1.00	1.00	1.00	1.00	1.00	1.00	1.00	1.00	1.00	1.00	1.00	1.00
Initial Bse:	179	687	88	364	613	166	420	1179	203	402	923	222
Added Vol:	9	21	14	32	14	6	21	22	11	11	15	26
PasserByVol:	0	0	0	0	0	0	0	0	0	0	0	0
Initial Fut:	188	708	102	396	627	172	441	1201	214	413	938	248
User Adj:	1.00	1.00	1.00	1.00	1.00	1.00	1.00	1.00	1.00	1.00	1.00	1.00
PHF Adj:	1.00	1.00	1.00	1.00	1.00	1.00	1.00	1.00	1.00	1.00	1.00	1.00
PHF Volume:	188	708	102	396	627	172	441	1201	214	413	938	248
Reduct Vol:	0	0	0	0	0	0	0	0	0	0	0	0
Reduced Vol:	188	708	102	396	627	172	441	1201	214	413	938	248
PCE Adj:	1.00	1.00	1.00	1.00	1.00	1.00	1.00	1.00	1.00	1.00	1.00	1.00
MLF Adj:	1.00	1.00	1.00	1.00	1.00	1.00	1.00	1.00	1.00	1.00	1.00	1.00
Final Volume:	188	708	102	396	627	172	441	1201	214	413	938	248
Saturation Flow Module:												
Sat/Lane:	1900	1900	1900	1900	1900	1900	1900	1900	1900	1900	1900	1900
Adjustment:	0.83	0.98	0.95	0.83	1.00	0.92	0.83	0.99	0.95	0.83	0.99	0.95
Lanes:	2.00	1.74	0.26	2.00	2.00	1.00	2.00	2.53	0.47	2.00	2.35	0.65
Final Sat.:	3150	3234	466	3150	3800	1750	3150	4752	847	3150	4427	1171
Capacity Analysis Module:												
Vol/Sat:	0.06	0.22	0.22	0.13	0.17	0.10	0.14	0.25	0.25	0.13	0.21	0.21
Crit Moves:	****			****			****			****		
Green Time:	16.3	41.5	41.5	23.8	49.0	49.0	28.9	47.9	47.9	24.8	43.8	43.8
Volume/Cap:	0.55	0.79	0.79	0.79	0.51	0.30	0.73	0.79	0.79	0.79	0.73	0.73
Uniform Del:	63.3	50.3	50.3	60.7	40.8	37.7	56.8	46.5	46.5	60.1	47.7	47.7
IncrementDel:	1.9	4.3	4.3	8.4	0.3	0.3	4.4	2.5	2.5	8.1	1.7	1.7
InitQueueDel:	0.0	0.0	0.0	0.0	0.0	0.0	0.0	0.0	0.0	0.0	0.0	0.0
Delay Adj:	1.00	1.00	1.00	1.00	1.00	1.00	1.00	1.00	1.00	1.00	1.00	1.00
Delay/Veh:	65.2	54.5	54.5	69.1	41.1	38.0	61.2	49.0	49.0	68.2	49.4	49.4
User DelAdj:	1.00	1.00	1.00	1.00	1.00	1.00	1.00	1.00	1.00	1.00	1.00	1.00
AdjDel/Veh:	65.2	54.5	54.5	69.1	41.1	38.0	61.2	49.0	49.0	68.2	49.4	49.4
LOS by Move:	E	D-	D-	E	D	D+	E	D	D	E	D	D
HCM2kAvgQ:	6	19	19	11	11	6	12	20	20	13	17	17

Note: Queue reported is the number of cars per lane.

San Antonio Village Phase III MTA
 SJ21-2068
 Background PM

Level Of Service Computation Report
 2000 HCM Operations (Future Volume Alternative)
 Background PP PM

Intersection #3: El Camino Real and San Antonio Road

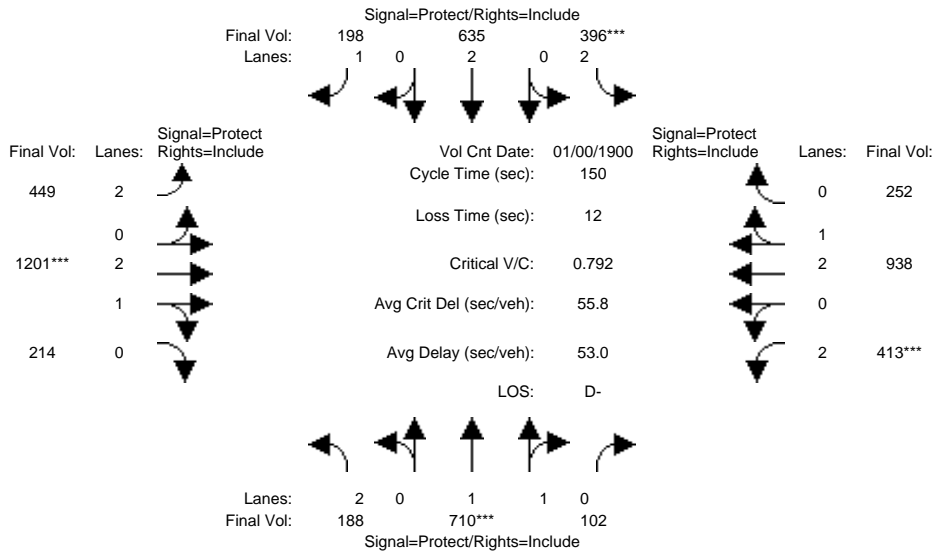

Approach:	North Bound			South Bound			East Bound			West Bound		
	L	T	R	L	T	R	L	T	R	L	T	R
Min. Green:	10	30	0	10	30	0	10	28	0	10	28	0
Y+R:	4.0	4.0	4.0	4.0	4.0	4.0	4.0	4.0	4.0	4.0	4.0	4.0
Volume Module: >> Count Date: 0 Jan 1900 << 12:00:00 AM												
Base Vol:	179	687	88	364	613	166	420	1179	203	402	923	222
Growth Adj:	1.00	1.00	1.00	1.00	1.00	1.00	1.00	1.00	1.00	1.00	1.00	1.00
Initial Bse:	179	687	88	364	613	166	420	1179	203	402	923	222
Added Vol:	9	23	14	32	22	32	29	22	11	11	15	30
PasserByVol:	0	0	0	0	0	0	0	0	0	0	0	0
Initial Fut:	188	710	102	396	635	198	449	1201	214	413	938	252
User Adj:	1.00	1.00	1.00	1.00	1.00	1.00	1.00	1.00	1.00	1.00	1.00	1.00
PHF Adj:	1.00	1.00	1.00	1.00	1.00	1.00	1.00	1.00	1.00	1.00	1.00	1.00
PHF Volume:	188	710	102	396	635	198	449	1201	214	413	938	252
Reduct Vol:	0	0	0	0	0	0	0	0	0	0	0	0
Reduced Vol:	188	710	102	396	635	198	449	1201	214	413	938	252
PCE Adj:	1.00	1.00	1.00	1.00	1.00	1.00	1.00	1.00	1.00	1.00	1.00	1.00
MLF Adj:	1.00	1.00	1.00	1.00	1.00	1.00	1.00	1.00	1.00	1.00	1.00	1.00
Final Volume:	188	710	102	396	635	198	449	1201	214	413	938	252
Saturation Flow Module:												
Sat/Lane:	1900	1900	1900	1900	1900	1900	1900	1900	1900	1900	1900	1900
Adjustment:	0.83	0.98	0.95	0.83	1.00	0.92	0.83	0.99	0.95	0.83	0.99	0.95
Lanes:	2.00	1.74	0.26	2.00	2.00	1.00	2.00	2.53	0.47	2.00	2.34	0.66
Final Sat.:	3150	3235	465	3150	3800	1750	3150	4752	847	3150	4413	1185
Capacity Analysis Module:												
Vol/Sat:	0.06	0.22	0.22	0.13	0.17	0.11	0.14	0.25	0.25	0.13	0.21	0.21
Crit Moves:	****			****			****			****		
Green Time:	16.3	41.5	41.5	23.8	49.0	49.0	29.2	47.8	47.8	24.8	43.5	43.5
Volume/Cap:	0.55	0.79	0.79	0.79	0.51	0.35	0.73	0.79	0.79	0.79	0.73	0.73
Delay/Veh:	65.2	54.5	54.5	69.2	41.2	38.7	61.3	49.1	49.1	68.2	49.8	49.8
User DelAdj:	1.00	1.00	1.00	1.00	1.00	1.00	1.00	1.00	1.00	1.00	1.00	1.00
AdjDel/Veh:	65.2	54.5	54.5	69.2	41.2	38.7	61.3	49.1	49.1	68.2	49.8	49.8
LOS by Move:	E	D-	D-	E	D	D+	E	D	D	E	D	D
HCM2kAvgQ:	6	19	19	11	11	7	12	20	20	13	18	18

Note: Queue reported is the number of cars per lane.

San Antonio Village Phase III MTA
 SJ21-2068
 Background PM

Level Of Service Computation Report
 2000 HCM Operations (Future Volume Alternative)
 Background PM

Intersection #4: El Camino Real and Showers Drive

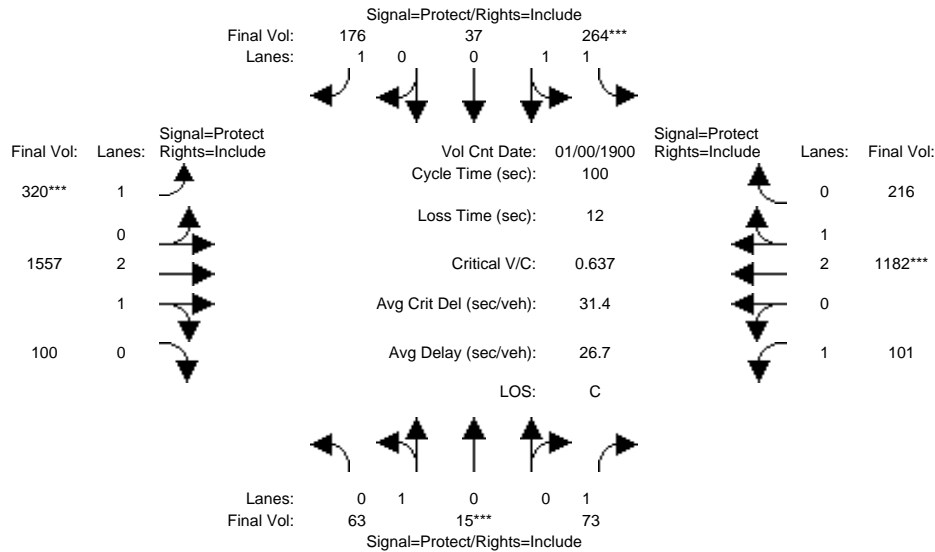

Approach:	North Bound			South Bound			East Bound			West Bound		
Movement:	L	T	R	L	T	R	L	T	R	L	T	R
Min. Green:	7	10	10	7	10	10	7	10	10	7	10	10
Y+R:	4.0	4.0	4.0	4.0	4.0	4.0	4.0	4.0	4.0	4.0	4.0	4.0
Volume Module: >> Count Date: 0 Jan 1900 << 12:00:00 AM												
Base Vol:	63	15	73	264	37	176	320	1489	100	101	1130	216
Growth Adj:	1.00	1.00	1.00	1.00	1.00	1.00	1.00	1.00	1.00	1.00	1.00	1.00
Initial Bse:	63	15	73	264	37	176	320	1489	100	101	1130	216
Added Vol:	0	0	0	0	0	0	0	68	0	0	52	0
PasserByVol:	0	0	0	0	0	0	0	0	0	0	0	0
Initial Fut:	63	15	73	264	37	176	320	1557	100	101	1182	216
User Adj:	1.00	1.00	1.00	1.00	1.00	1.00	1.00	1.00	1.00	1.00	1.00	1.00
PHF Adj:	1.00	1.00	1.00	1.00	1.00	1.00	1.00	1.00	1.00	1.00	1.00	1.00
PHF Volume:	63	15	73	264	37	176	320	1557	100	101	1182	216
Reduct Vol:	0	0	0	0	0	0	0	0	0	0	0	0
Reduced Vol:	63	15	73	264	37	176	320	1557	100	101	1182	216
PCE Adj:	1.00	1.00	1.00	1.00	1.00	1.00	1.00	1.00	1.00	1.00	1.00	1.00
MLF Adj:	1.00	1.00	1.00	1.00	1.00	1.00	1.00	1.00	1.00	1.00	1.00	1.00
Final Volume:	63	15	73	264	37	176	320	1557	100	101	1182	216
Saturation Flow Module:												
Sat/Lane:	1900	1900	1900	1900	1900	1900	1900	1900	1900	1900	1900	1900
Adjustment:	0.95	0.95	0.92	0.93	0.95	0.92	0.92	0.98	0.95	0.92	0.99	0.95
Lanes:	0.81	0.19	1.00	1.76	0.24	1.00	1.00	2.81	0.19	1.00	2.52	0.48
Final Sat.:	1454	346	1750	3114	436	1750	1750	5262	338	1750	4734	865
Capacity Analysis Module:												
Vol/Sat:	0.04	0.04	0.04	0.08	0.08	0.10	0.18	0.30	0.30	0.06	0.25	0.25
Crit Moves:	****			****			****			****		
Green Time:	9.4	10.0	10.0	12.8	13.4	13.4	27.6	52.7	52.7	12.5	37.6	37.6
Volume/Cap:	0.46	0.43	0.42	0.66	0.63	0.75	0.66	0.56	0.56	0.46	0.66	0.66
Uniform Del:	42.9	42.3	42.3	41.6	40.9	41.7	32.1	15.9	15.9	40.6	25.9	25.9
IncrementDel:	2.0	1.7	1.6	3.7	2.7	12.5	3.5	0.2	0.2	1.6	0.8	0.8
InitQueueDel:	0.0	0.0	0.0	0.0	0.0	0.0	0.0	0.0	0.0	0.0	0.0	0.0
Delay Adj:	1.00	1.00	1.00	1.00	1.00	1.00	1.00	1.00	1.00	1.00	1.00	1.00
Delay/Veh:	45.0	44.0	43.9	45.2	43.7	54.1	35.6	16.1	16.1	42.2	26.7	26.7
User DelAdj:	1.00	1.00	1.00	1.00	1.00	1.00	1.00	1.00	1.00	1.00	1.00	1.00
AdjDel/Veh:	45.0	44.0	43.9	45.2	43.7	54.1	35.6	16.1	16.1	42.2	26.7	26.7
LOS by Move:	D	D	D	D	D	D-	D+	B	B	D	C	C
HCM2kAvgQ:	3	3	3	5	5	6	10	12	12	4	13	13

Note: Queue reported is the number of cars per lane.

San Antonio Village Phase III MTA
 SJ21-2068
 Background PM

Level Of Service Computation Report
 2000 HCM Operations (Future Volume Alternative)
 Background PP PM

Intersection #4: El Camino Real and Showers Drive

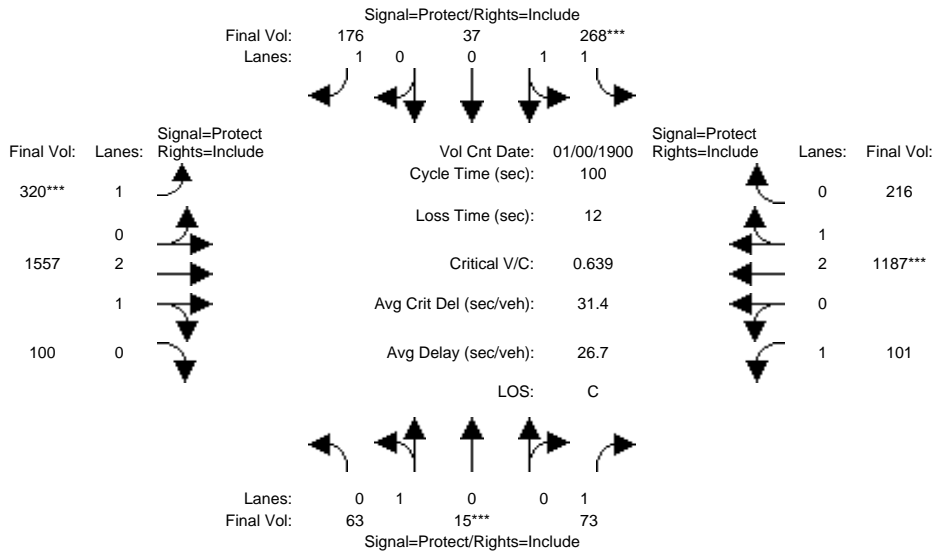

Approach:	North Bound			South Bound			East Bound			West Bound		
	L	T	R	L	T	R	L	T	R	L	T	R
Min. Green:	7	10	10	7	10	10	7	10	10	7	10	10
Y+R:	4.0	4.0	4.0	4.0	4.0	4.0	4.0	4.0	4.0	4.0	4.0	4.0
Volume Module: >> Count Date: 0 Jan 1900 << 12:00:00 AM												
Base Vol:	63	15	73	264	37	176	320	1489	100	101	1130	216
Growth Adj:	1.00	1.00	1.00	1.00	1.00	1.00	1.00	1.00	1.00	1.00	1.00	1.00
Initial Bse:	63	15	73	264	37	176	320	1489	100	101	1130	216
Added Vol:	0	0	0	4	0	0	0	68	0	0	57	0
PasserByVol:	0	0	0	0	0	0	0	0	0	0	0	0
Initial Fut:	63	15	73	268	37	176	320	1557	100	101	1187	216
User Adj:	1.00	1.00	1.00	1.00	1.00	1.00	1.00	1.00	1.00	1.00	1.00	1.00
PHF Adj:	1.00	1.00	1.00	1.00	1.00	1.00	1.00	1.00	1.00	1.00	1.00	1.00
PHF Volume:	63	15	73	268	37	176	320	1557	100	101	1187	216
Reduct Vol:	0	0	0	0	0	0	0	0	0	0	0	0
Reduced Vol:	63	15	73	268	37	176	320	1557	100	101	1187	216
PCE Adj:	1.00	1.00	1.00	1.00	1.00	1.00	1.00	1.00	1.00	1.00	1.00	1.00
MLF Adj:	1.00	1.00	1.00	1.00	1.00	1.00	1.00	1.00	1.00	1.00	1.00	1.00
FinalVolume:	63	15	73	268	37	176	320	1557	100	101	1187	216
Saturation Flow Module:												
Sat/Lane:	1900	1900	1900	1900	1900	1900	1900	1900	1900	1900	1900	1900
Adjustment:	0.95	0.95	0.92	0.93	0.95	0.92	0.92	0.98	0.95	0.92	0.99	0.95
Lanes:	0.81	0.19	1.00	1.76	0.24	1.00	1.00	2.81	0.19	1.00	2.52	0.48
Final Sat.:	1454	346	1750	3119	431	1750	1750	5262	338	1750	4737	862
Capacity Analysis Module:												
Vol/Sat:	0.04	0.04	0.04	0.09	0.09	0.10	0.18	0.30	0.30	0.06	0.25	0.25
Crit Moves:	****	****	****	****	****	****	****	****	****	****	****	****
Green Time:	9.4	10.0	10.0	12.9	13.5	13.5	27.5	52.6	52.6	12.5	37.6	37.6
Volume/Cap:	0.46	0.43	0.42	0.67	0.64	0.74	0.67	0.56	0.56	0.46	0.67	0.67
Delay/Veh:	44.9	44.0	43.9	45.2	43.8	53.7	35.7	16.2	16.2	42.2	26.8	26.8
User DelAdj:	1.00	1.00	1.00	1.00	1.00	1.00	1.00	1.00	1.00	1.00	1.00	1.00
AdjDel/Veh:	44.9	44.0	43.9	45.2	43.8	53.7	35.7	16.2	16.2	42.2	26.8	26.8
LOS by Move:	D	D	D	D	D	D-	D+	B	B	D	C	C
HCM2kAvgQ:	3	3	3	5	5	6	10	12	12	4	13	13

Note: Queue reported is the number of cars per lane.

San Antonio Village Phase III MTA
 SJ21-2068
 Background PM

Level Of Service Computation Report
 2000 HCM Operations (Future Volume Alternative)
 Background PM

Intersection #5: El Camino Real and Ortega Avenue

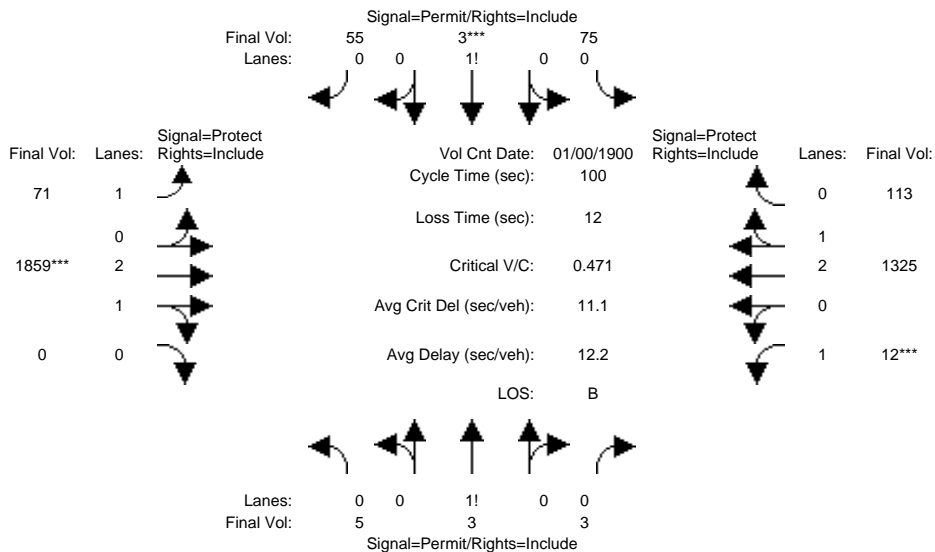

Approach:	North Bound			South Bound			East Bound			West Bound		
	L	T	R	L	T	R	L	T	R	L	T	R
Min. Green:	10	10	10	10	10	10	7	10	10	7	10	10
Y+R:	4.0	4.0	4.0	4.0	4.0	4.0	4.0	4.0	4.0	4.0	4.0	4.0
Volume Module: >> Count Date: 0 Jan 1900 << 12:00:00 AM												
Base Vol:	5	3	3	75	3	55	71	1798	0	12	1270	113
Growth Adj:	1.00	1.00	1.00	1.00	1.00	1.00	1.00	1.00	1.00	1.00	1.00	1.00
Initial Bse:	5	3	3	75	3	55	71	1798	0	12	1270	113
Added Vol:	0	0	0	0	0	0	0	61	0	0	55	0
PasserByVol:	0	0	0	0	0	0	0	0	0	0	0	0
Initial Fut:	5	3	3	75	3	55	71	1859	0	12	1325	113
User Adj:	1.00	1.00	1.00	1.00	1.00	1.00	1.00	1.00	1.00	1.00	1.00	1.00
PHF Adj:	1.00	1.00	1.00	1.00	1.00	1.00	1.00	1.00	1.00	1.00	1.00	1.00
PHF Volume:	5	3	3	75	3	55	71	1859	0	12	1325	113
Reduct Vol:	0	0	0	0	0	0	0	0	0	0	0	0
Reduced Vol:	5	3	3	75	3	55	71	1859	0	12	1325	113
PCE Adj:	1.00	1.00	1.00	1.00	1.00	1.00	1.00	1.00	1.00	1.00	1.00	1.00
MLF Adj:	1.00	1.00	1.00	1.00	1.00	1.00	1.00	1.00	1.00	1.00	1.00	1.00
FinalVolume:	5	3	3	75	3	55	71	1859	0	12	1325	113
Saturation Flow Module:												
Sat/Lane:	1900	1900	1900	1900	1900	1900	1900	1900	1900	1900	1900	1900
Adjustment:	0.92	0.92	0.92	0.92	0.92	0.92	0.92	0.98	0.92	0.92	0.99	0.95
Lanes:	0.46	0.27	0.27	0.57	0.02	0.41	1.00	3.00	0.00	1.00	2.76	0.24
Final Sat.:	795	477	477	987	39	724	1750	5600	0	1750	5159	440
Capacity Analysis Module:												
Vol/Sat:	0.01	0.01	0.01	0.08	0.08	0.08	0.04	0.33	0.00	0.01	0.26	0.26
Crit Moves:				****			****			****		
Green Time:	15.1	15.1	15.1	15.1	15.1	15.1	15.6	65.9	0.0	7.0	57.3	57.3
Volume/Cap:	0.04	0.04	0.04	0.50	0.50	0.50	0.26	0.50	0.00	0.10	0.45	0.45
Uniform Del:	36.3	36.3	36.3	39.0	39.0	39.0	37.1	8.7	0.0	43.5	12.3	12.3
IncramntDel:	0.1	0.1	0.1	1.6	1.6	1.6	0.5	0.1	0.0	0.4	0.1	0.1
InitQueuDel:	0.0	0.0	0.0	0.0	0.0	0.0	0.0	0.0	0.0	0.0	0.0	0.0
Delay Adj:	1.00	1.00	1.00	1.00	1.00	1.00	1.00	1.00	0.00	1.00	1.00	1.00
Delay/Veh:	36.3	36.3	36.3	40.6	40.6	40.6	37.6	8.8	0.0	43.9	12.4	12.4
User DelAdj:	1.00	1.00	1.00	1.00	1.00	1.00	1.00	1.00	1.00	1.00	1.00	1.00
AdjDel/Veh:	36.3	36.3	36.3	40.6	40.6	40.6	37.6	8.8	0.0	43.9	12.4	12.4
LOS by Move:	D+	D+	D+	D	D	D	D+	A	A	D	B	B
HCM2kAvgQ:	0	0	0	5	5	5	2	10	0	0	9	9

Note: Queue reported is the number of cars per lane.

San Antonio Village Phase III MTA
 SJ21-2068
 Background PM

Level Of Service Computation Report
 2000 HCM Operations (Future Volume Alternative)
 Background PP PM

Intersection #5: El Camino Real and Ortega Avenue

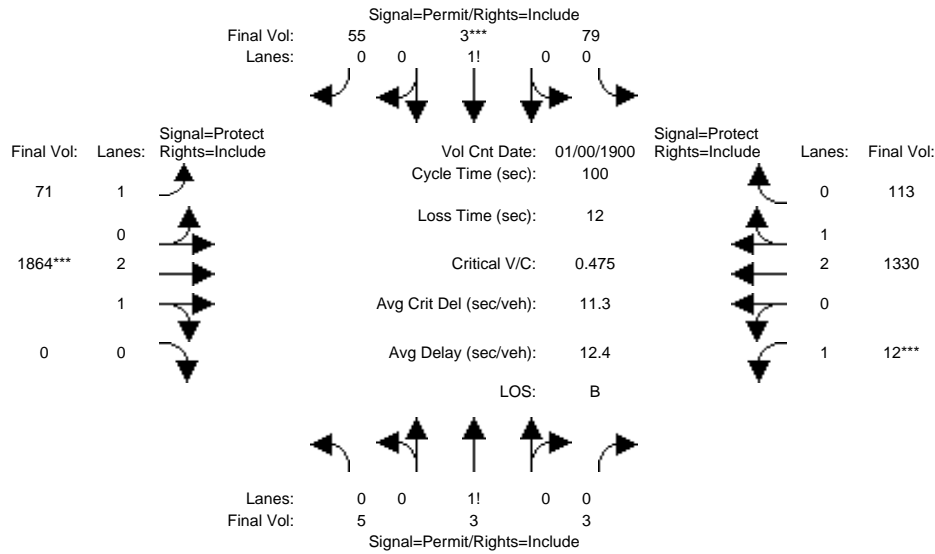

Approach:	North Bound			South Bound			East Bound			West Bound		
	L	T	R	L	T	R	L	T	R	L	T	R
Min. Green:	10	10	10	10	10	10	7	10	10	7	10	10
Y+R:	4.0	4.0	4.0	4.0	4.0	4.0	4.0	4.0	4.0	4.0	4.0	4.0
Volume Module: >> Count Date: 0 Jan 1900 << 12:00:00 AM												
Base Vol:	5	3	3	75	3	55	71	1798	0	12	1270	113
Growth Adj:	1.00	1.00	1.00	1.00	1.00	1.00	1.00	1.00	1.00	1.00	1.00	1.00
Initial Bse:	5	3	3	75	3	55	71	1798	0	12	1270	113
Added Vol:	0	0	0	4	0	0	0	66	0	0	60	0
PasserByVol:	0	0	0	0	0	0	0	0	0	0	0	0
Initial Fut:	5	3	3	79	3	55	71	1864	0	12	1330	113
User Adj:	1.00	1.00	1.00	1.00	1.00	1.00	1.00	1.00	1.00	1.00	1.00	1.00
PHF Adj:	1.00	1.00	1.00	1.00	1.00	1.00	1.00	1.00	1.00	1.00	1.00	1.00
PHF Volume:	5	3	3	79	3	55	71	1864	0	12	1330	113
Reduct Vol:	0	0	0	0	0	0	0	0	0	0	0	0
Reduced Vol:	5	3	3	79	3	55	71	1864	0	12	1330	113
PCE Adj:	1.00	1.00	1.00	1.00	1.00	1.00	1.00	1.00	1.00	1.00	1.00	1.00
MLF Adj:	1.00	1.00	1.00	1.00	1.00	1.00	1.00	1.00	1.00	1.00	1.00	1.00
FinalVolume:	5	3	3	79	3	55	71	1864	0	12	1330	113
Saturation Flow Module:												
Sat/Lane:	1900	1900	1900	1900	1900	1900	1900	1900	1900	1900	1900	1900
Adjustment:	0.92	0.92	0.92	0.92	0.92	0.92	0.92	0.98	0.92	0.92	0.99	0.95
Lanes:	0.46	0.27	0.27	0.58	0.02	0.40	1.00	3.00	0.00	1.00	2.76	0.24
Final Sat.:	795	477	477	1009	38	703	1750	5600	0	1750	5161	438
Capacity Analysis Module:												
Vol/Sat:	0.01	0.01	0.01	0.08	0.08	0.08	0.04	0.33	0.00	0.01	0.26	0.26
Crit Moves:				****			****			****		
Green Time:	15.4	15.4	15.4	15.4	15.4	15.4	15.5	65.6	0.0	7.0	57.1	57.1
Volume/Cap:	0.04	0.04	0.04	0.51	0.51	0.51	0.26	0.51	0.00	0.10	0.45	0.45
Delay/Veh:	36.1	36.1	36.1	40.4	40.4	40.4	37.7	9.0	0.0	43.9	12.5	12.5
User DelAdj:	1.00	1.00	1.00	1.00	1.00	1.00	1.00	1.00	1.00	1.00	1.00	1.00
AdjDel/Veh:	36.1	36.1	36.1	40.4	40.4	40.4	37.7	9.0	0.0	43.9	12.5	12.5
LOS by Move:	D+	D+	D+	D	D	D	D+	A	A	D	B	B
HCM2kAvgQ:	0	0	0	5	5	5	2	10	0	0	9	9

Note: Queue reported is the number of cars per lane.

San Antonio Village Phase III MTA
 SJ21-2068
 Background PM

Level Of Service Computation Report
 2000 HCM Operations (Future Volume Alternative)
 Background PM

Intersection #6: El Camino Real and Rengstorff Avenue

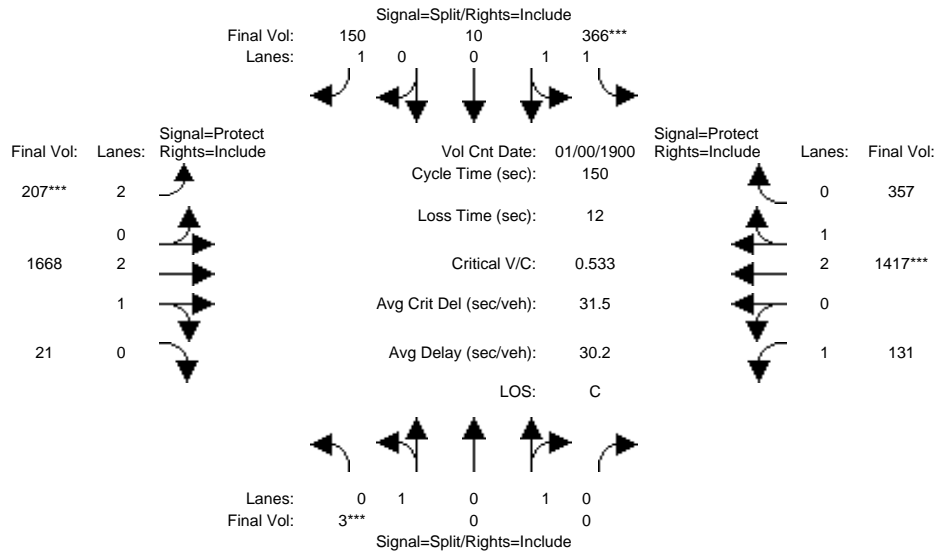

Approach:	North Bound			South Bound			East Bound			West Bound		
	L	T	R	L	T	R	L	T	R	L	T	R
Min. Green:	10	0	0	10	0	0	10	30	0	10	30	0
Y+R:	4.0	4.0	4.0	4.0	4.0	4.0	4.0	4.0	4.0	4.0	4.0	4.0

Volume Module:	>> Count Date: 0 Jan 1900 << 12:00:00 AM											
Base Vol:	3	0	0	364	0	136	196	1642	0	123	1378	352
Growth Adj:	1.00	1.00	1.00	1.00	1.00	1.00	1.00	1.00	1.00	1.00	1.00	1.00
Initial Bse:	3	0	0	364	0	136	196	1642	0	123	1378	352
Added Vol:	0	0	0	2	10	14	11	26	21	8	39	5
PasserByVol:	0	0	0	0	0	0	0	0	0	0	0	0
Initial Fut:	3	0	0	366	10	150	207	1668	21	131	1417	357
User Adj:	1.00	1.00	1.00	1.00	1.00	1.00	1.00	1.00	1.00	1.00	1.00	1.00
PHF Adj:	1.00	1.00	1.00	1.00	1.00	1.00	1.00	1.00	1.00	1.00	1.00	1.00
PHF Volume:	3	0	0	366	10	150	207	1668	21	131	1417	357
Reduct Vol:	0	0	0	0	0	0	0	0	0	0	0	0
Reduced Vol:	3	0	0	366	10	150	207	1668	21	131	1417	357
PCE Adj:	1.00	1.00	1.00	1.00	1.00	1.00	1.00	1.00	1.00	1.00	1.00	1.00
MLF Adj:	1.00	1.00	1.00	1.00	1.00	1.00	1.00	1.00	1.00	1.00	1.00	1.00
FinalVolume:	3	0	0	366	10	150	207	1668	21	131	1417	357

Saturation Flow Module:												
Sat/Lane:	1900	1900	1900	1900	1900	1900	1900	1900	1900	1900	1900	1900
Adjustment:	0.95	1.00	0.92	0.93	0.95	0.92	0.83	0.98	0.95	0.92	0.99	0.95
Lanes:	1.00	0.00	1.00	1.95	0.05	1.00	2.00	2.96	0.04	1.00	2.37	0.63
Final Sat.:	1800	0	1750	3456	94	1750	3150	5530	70	1750	4472	1127

Capacity Analysis Module:												
Vol/Sat:	0.00	0.00	0.00	0.11	0.11	0.09	0.07	0.30	0.30	0.07	0.32	0.32
Crit Moves:	****			****			****			****		
Green Time:	10.0	0.0	0.0	27.8	27.8	27.8	17.2	80.3	80.3	19.9	83.0	83.0
Volume/Cap:	0.03	0.00	0.00	0.57	0.57	0.46	0.57	0.56	0.56	0.56	0.57	0.57
Uniform Del:	65.4	0.0	0.0	55.7	55.7	54.5	62.9	23.2	23.2	61.0	21.9	21.9
IncrcmntDel:	0.1	0.0	0.0	1.2	1.2	1.1	2.2	0.2	0.2	3.2	0.3	0.3
InitQueuDel:	0.0	0.0	0.0	0.0	0.0	0.0	0.0	0.0	0.0	0.0	0.0	0.0
Delay Adj:	1.00	0.00	0.00	1.00	1.00	1.00	1.00	1.00	1.00	1.00	1.00	1.00
Delay/Veh:	65.5	0.0	0.0	56.9	56.9	55.5	65.1	23.4	23.4	64.1	22.1	22.1
User DelAdj:	1.00	1.00	1.00	1.00	1.00	1.00	1.00	1.00	1.00	1.00	1.00	1.00
AdjDel/Veh:	65.5	0.0	0.0	56.9	56.9	55.5	65.1	23.4	23.4	64.1	22.1	22.1
LOS by Move:	E	A	A	E+	E+	E+	E	C	C	E	C+	C+
HCM2kAvgQ:	0	0	0	8	8	6	5	17	17	7	18	18

Note: Queue reported is the number of cars per lane.

San Antonio Village Phase III MTA
 SJ21-2068
 Background PM

Level Of Service Computation Report
 2000 HCM Operations (Future Volume Alternative)
 Background PP PM

Intersection #6: El Camino Real and Rengstorff Avenue

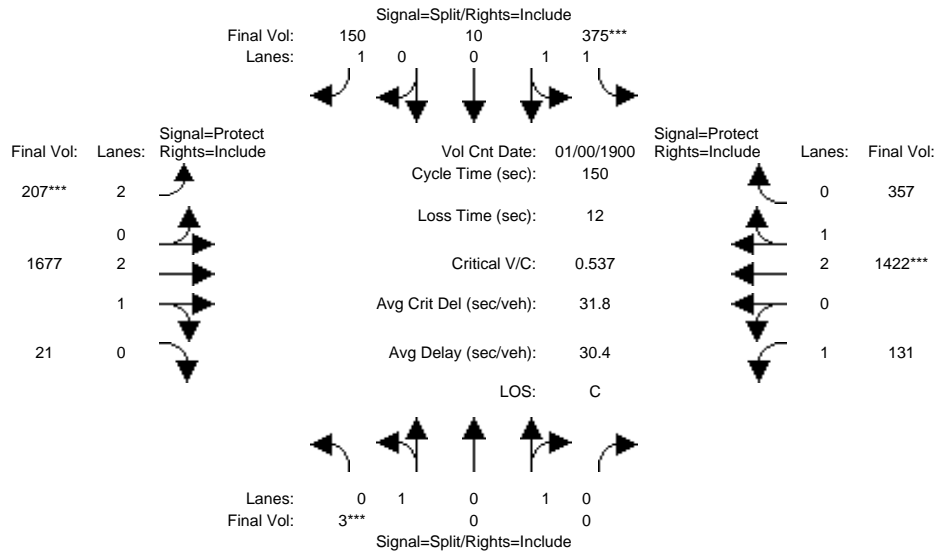

Approach:	North Bound			South Bound			East Bound			West Bound		
	L	T	R	L	T	R	L	T	R	L	T	R
Min. Green:	10	0	0	10	0	0	10	30	0	10	30	0
Y+R:	4.0	4.0	4.0	4.0	4.0	4.0	4.0	4.0	4.0	4.0	4.0	4.0
Volume Module: >> Count Date: 0 Jan 1900 << 12:00:00 AM												
Base Vol:	3	0	0	364	0	136	196	1642	0	123	1378	352
Growth Adj:	1.00	1.00	1.00	1.00	1.00	1.00	1.00	1.00	1.00	1.00	1.00	1.00
Initial Bse:	3	0	0	364	0	136	196	1642	0	123	1378	352
Added Vol:	0	0	0	11	10	14	11	35	21	8	44	5
PasserByVol:	0	0	0	0	0	0	0	0	0	0	0	0
Initial Fut:	3	0	0	375	10	150	207	1677	21	131	1422	357
User Adj:	1.00	1.00	1.00	1.00	1.00	1.00	1.00	1.00	1.00	1.00	1.00	1.00
PHF Adj:	1.00	1.00	1.00	1.00	1.00	1.00	1.00	1.00	1.00	1.00	1.00	1.00
PHF Volume:	3	0	0	375	10	150	207	1677	21	131	1422	357
Reduct Vol:	0	0	0	0	0	0	0	0	0	0	0	0
Reduced Vol:	3	0	0	375	10	150	207	1677	21	131	1422	357
PCE Adj:	1.00	1.00	1.00	1.00	1.00	1.00	1.00	1.00	1.00	1.00	1.00	1.00
MLF Adj:	1.00	1.00	1.00	1.00	1.00	1.00	1.00	1.00	1.00	1.00	1.00	1.00
FinalVolume:	3	0	0	375	10	150	207	1677	21	131	1422	357
Saturation Flow Module:												
Sat/Lane:	1900	1900	1900	1900	1900	1900	1900	1900	1900	1900	1900	1900
Adjustment:	0.95	1.00	0.92	0.93	0.95	0.92	0.83	0.98	0.95	0.92	0.99	0.95
Lanes:	1.00	0.00	1.00	1.95	0.05	1.00	2.00	2.96	0.04	1.00	2.38	0.62
Final Sat.:	1800	0	1750	3458	92	1750	3150	5531	69	1750	4475	1123
Capacity Analysis Module:												
Vol/Sat:	0.00	0.00	0.00	0.11	0.11	0.09	0.07	0.30	0.30	0.07	0.32	0.32
Crit Moves:	****			****			****			****		
Green Time:	10.0	0.0	0.0	28.2	28.2	28.2	17.1	80.0	80.0	19.8	82.7	82.7
Volume/Cap:	0.03	0.00	0.00	0.58	0.58	0.46	0.58	0.57	0.57	0.57	0.58	0.58
Delay/Veh:	65.5	0.0	0.0	56.7	56.7	55.1	65.3	23.7	23.7	64.4	22.4	22.4
User DelAdj:	1.00	1.00	1.00	1.00	1.00	1.00	1.00	1.00	1.00	1.00	1.00	1.00
AdjDel/Veh:	65.5	0.0	0.0	56.7	56.7	55.1	65.3	23.7	23.7	64.4	22.4	22.4
LOS by Move:	E	A	A	E+	E+	E+	E	C	C	E	C+	C+
HCM2kAvgQ:	0	0	0	8	8	6	5	17	17	7	18	18

Note: Queue reported is the number of cars per lane.

San Antonio Village Phase III MTA
 SJ21-2068
 Background PM

Level Of Service Computation Report
 2000 HCM Operations (Future Volume Alternative)
 Background PM

Intersection #7: Fayette Drive and San Antonio Road

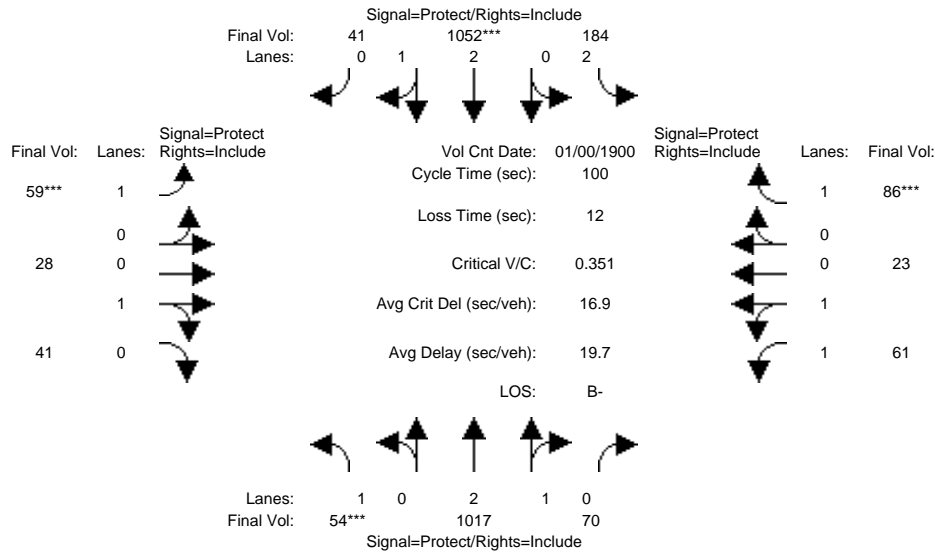

Approach:	North Bound			South Bound			East Bound			West Bound		
	L	T	R	L	T	R	L	T	R	L	T	R
Min. Green:	7	10	10	7	10	10	7	10	10	7	10	10
Y+R:	4.0	4.0	4.0	4.0	4.0	4.0	4.0	4.0	4.0	4.0	4.0	4.0
Volume Module: >> Count Date: 0 Jan 1900 << 12:00:00 AM												
Base Vol:	48	955	70	184	1004	35	55	28	37	61	23	86
Growth Adj:	1.00	1.00	1.00	1.00	1.00	1.00	1.00	1.00	1.00	1.00	1.00	1.00
Initial Bse:	48	955	70	184	1004	35	55	28	37	61	23	86
Added Vol:	6	62	0	0	48	6	4	0	4	0	0	0
PasserByVol:	0	0	0	0	0	0	0	0	0	0	0	0
Initial Fut:	54	1017	70	184	1052	41	59	28	41	61	23	86
User Adj:	1.00	1.00	1.00	1.00	1.00	1.00	1.00	1.00	1.00	1.00	1.00	1.00
PHF Adj:	1.00	1.00	1.00	1.00	1.00	1.00	1.00	1.00	1.00	1.00	1.00	1.00
PHF Volume:	54	1017	70	184	1052	41	59	28	41	61	23	86
Reduct Vol:	0	0	0	0	0	0	0	0	0	0	0	0
Reduced Vol:	54	1017	70	184	1052	41	59	28	41	61	23	86
PCE Adj:	1.00	1.00	1.00	1.00	1.00	1.00	1.00	1.00	1.00	1.00	1.00	1.00
MLF Adj:	1.00	1.00	1.00	1.00	1.00	1.00	1.00	1.00	1.00	1.00	1.00	1.00
FinalVolume:	54	1017	70	184	1052	41	59	28	41	61	23	86
Saturation Flow Module:												
Sat/Lane:	1900	1900	1900	1900	1900	1900	1900	1900	1900	1900	1900	1900
Adjustment:	0.92	0.98	0.95	0.83	0.98	0.95	0.92	0.95	0.95	0.93	0.95	0.92
Lanes:	1.00	2.80	0.20	2.00	2.88	0.12	1.00	0.41	0.59	1.46	0.54	1.00
Final Sat.:	1750	5239	361	3150	5390	210	1750	730	1070	2578	972	1750
Capacity Analysis Module:												
Vol/Sat:	0.03	0.19	0.19	0.06	0.20	0.20	0.03	0.04	0.04	0.02	0.02	0.05
Crit Moves:	****			****			****					****
Green Time:	8.8	47.3	47.3	17.1	55.6	55.6	9.6	13.9	13.9	9.7	14.0	14.0
Volume/Cap:	0.35	0.41	0.41	0.34	0.35	0.35	0.35	0.28	0.28	0.24	0.17	0.35
Uniform Del:	42.9	17.2	17.2	36.5	12.2	12.2	42.3	38.6	38.6	41.7	37.9	38.9
IncrcmntDel:	1.4	0.1	0.1	0.4	0.1	0.1	1.3	0.6	0.6	0.4	0.2	0.9
InitQueuDel:	0.0	0.0	0.0	0.0	0.0	0.0	0.0	0.0	0.0	0.0	0.0	0.0
Delay Adj:	1.00	1.00	1.00	1.00	1.00	1.00	1.00	1.00	1.00	1.00	1.00	1.00
Delay/Veh:	44.3	17.3	17.3	36.9	12.3	12.3	43.6	39.2	39.2	42.1	38.0	39.8
User DelAdj:	1.00	1.00	1.00	1.00	1.00	1.00	1.00	1.00	1.00	1.00	1.00	1.00
AdjDel/Veh:	44.3	17.3	17.3	36.9	12.3	12.3	43.6	39.2	39.2	42.1	38.0	39.8
LOS by Move:	D	B	B	D+	B	B	D	D	D	D	D+	D
HCM2kAvgQ:	2	7	7	3	6	6	2	2	2	1	1	3

Note: Queue reported is the number of cars per lane.

San Antonio Village Phase III MTA
 SJ21-2068
 Background PM

Level Of Service Computation Report
 2000 HCM Operations (Future Volume Alternative)
 Background PP PM

Intersection #7: Fayette Drive and San Antonio Road

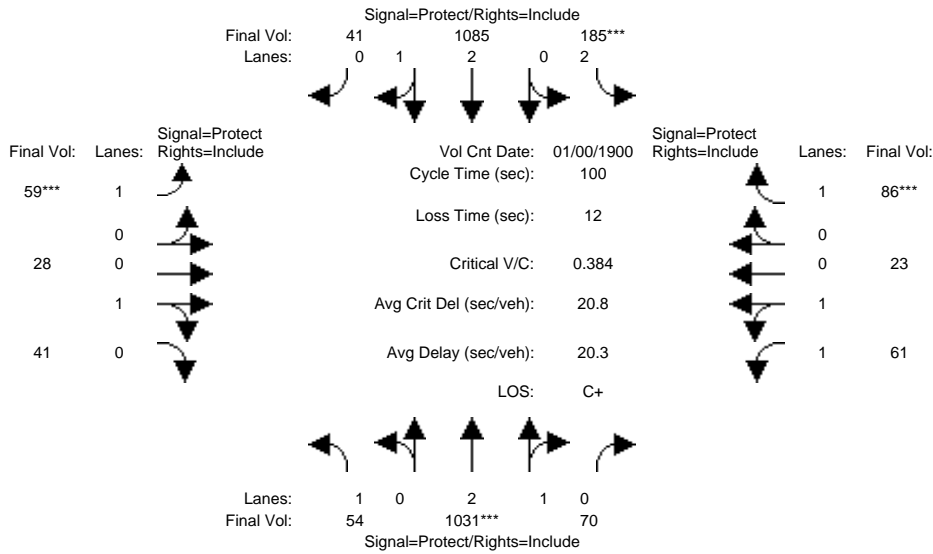

Approach:	North Bound			South Bound			East Bound			West Bound		
	L	T	R	L	T	R	L	T	R	L	T	R
Min. Green:	7	10	10	7	10	10	7	10	10	7	10	10
Y+R:	4.0	4.0	4.0	4.0	4.0	4.0	4.0	4.0	4.0	4.0	4.0	4.0
Volume Module:	>> Count Date: 0 Jan 1900 << 12:00:00 AM											
Base Vol:	48	955	70	184	1004	35	55	28	37	61	23	86
Growth Adj:	1.00	1.00	1.00	1.00	1.00	1.00	1.00	1.00	1.00	1.00	1.00	1.00
Initial Bse:	48	955	70	184	1004	35	55	28	37	61	23	86
Added Vol:	6	76	0	1	81	6	4	0	4	0	0	0
PasserByVol:	0	0	0	0	0	0	0	0	0	0	0	0
Initial Fut:	54	1031	70	185	1085	41	59	28	41	61	23	86
User Adj:	1.00	1.00	1.00	1.00	1.00	1.00	1.00	1.00	1.00	1.00	1.00	1.00
PHF Adj:	1.00	1.00	1.00	1.00	1.00	1.00	1.00	1.00	1.00	1.00	1.00	1.00
PHF Volume:	54	1031	70	185	1085	41	59	28	41	61	23	86
Reduct Vol:	0	0	0	0	0	0	0	0	0	0	0	0
Reduced Vol:	54	1031	70	185	1085	41	59	28	41	61	23	86
PCE Adj:	1.00	1.00	1.00	1.00	1.00	1.00	1.00	1.00	1.00	1.00	1.00	1.00
MLF Adj:	1.00	1.00	1.00	1.00	1.00	1.00	1.00	1.00	1.00	1.00	1.00	1.00
Final Volume:	54	1031	70	185	1085	41	59	28	41	61	23	86
Saturation Flow Module:												
Sat/Lane:	1900	1900	1900	1900	1900	1900	1900	1900	1900	1900	1900	1900
Adjustment:	0.92	0.98	0.95	0.83	0.98	0.95	0.92	0.95	0.95	0.93	0.95	0.92
Lanes:	1.00	2.80	0.20	2.00	2.89	0.11	1.00	0.41	0.59	1.46	0.54	1.00
Final Sat.:	1750	5243	356	3150	5396	204	1750	730	1070	2578	972	1750
Capacity Analysis Module:												
Vol/Sat:	0.03	0.20	0.20	0.06	0.20	0.20	0.03	0.04	0.04	0.02	0.02	0.05
Crit Moves:	****			****			****			****		
Green Time:	17.2	51.2	51.2	15.3	49.3	49.3	8.8	12.7	12.7	8.9	12.8	12.8
Volume/Cap:	0.18	0.38	0.38	0.38	0.41	0.41	0.38	0.30	0.30	0.27	0.19	0.38
Delay/Veh:	35.7	14.9	14.9	38.6	16.2	16.2	44.7	40.4	40.4	43.0	39.2	41.1
User DelAdj:	1.00	1.00	1.00	1.00	1.00	1.00	1.00	1.00	1.00	1.00	1.00	1.00
AdjDel/Veh:	35.7	14.9	14.9	38.6	16.2	16.2	44.7	40.4	40.4	43.0	39.2	41.1
LOS by Move:	D+	B	B	D+	B	B	D	D	D	D	D	D
HCM2kAvgQ:	1	7	7	3	7	7	2	2	2	2	1	3

Note: Queue reported is the number of cars per lane.

San Antonio Village Phase III MTA
SJ21-2068
Background PM

Level Of Service Computation Report
2000 HCM Unsignalized (Future Volume Alternative)
Background PM

Intersection #8: Miller Avenue and San Antonio Road

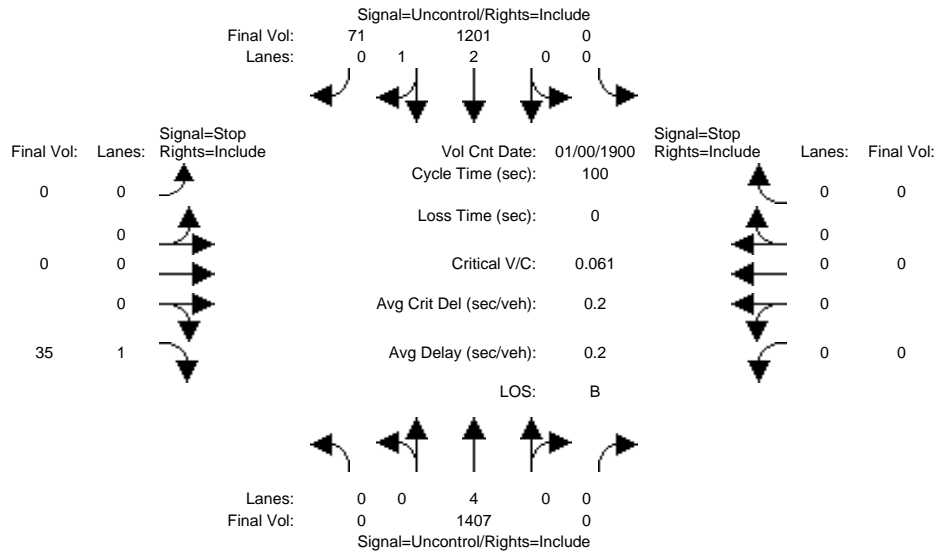

Approach:	North Bound			South Bound			East Bound			West Bound		
	L	T	R	L	T	R	L	T	R	L	T	R
Volume Module: >> Count Date: 0 Jan 1900 << 12:00:00 AM												
Base Vol:	0	1341	0	0	1147	71	0	0	35	0	0	0
Growth Adj:	1.00	1.00	1.00	1.00	1.00	1.00	1.00	1.00	1.00	1.00	1.00	1.00
Initial Bse:	0	1341	0	0	1147	71	0	0	35	0	0	0
Added Vol:	0	66	0	0	54	0	0	0	0	0	0	0
PasserByVol:	0	0	0	0	0	0	0	0	0	0	0	0
Initial Fut:	0	1407	0	0	1201	71	0	0	35	0	0	0
User Adj:	1.00	1.00	1.00	1.00	1.00	1.00	1.00	1.00	1.00	1.00	1.00	1.00
PHF Adj:	1.00	1.00	1.00	1.00	1.00	1.00	1.00	1.00	1.00	1.00	1.00	1.00
PHF Volume:	0	1407	0	0	1201	71	0	0	35	0	0	0
Reduct Vol:	0	0	0	0	0	0	0	0	0	0	0	0
FinalVolume:	0	1407	0	0	1201	71	0	0	35	0	0	0
Critical Gap Module:												
Critical Gp:	xxxxx	xxxx	xxxxx	xxxxx	xxxx	xxxxx	xxxxx	xxxx	6.9	xxxxx	xxxx	xxxxx
FollowUpTim:	xxxxx	xxxx	xxxxx	xxxxx	xxxx	xxxxx	xxxxx	xxxx	3.3	xxxxx	xxxx	xxxxx
Capacity Module:												
Cnflct Vol:	xxxx	xxxx	xxxxx	xxxx	xxxx	xxxxx	xxxx	xxxx	436	xxxx	xxxx	xxxxx
Potent Cap.:	xxxx	xxxx	xxxxx	xxxx	xxxx	xxxxx	xxxx	xxxx	574	xxxx	xxxx	xxxxx
Move Cap.:	xxxx	xxxx	xxxxx	xxxx	xxxx	xxxxx	xxxx	xxxx	574	xxxx	xxxx	xxxxx
Volume/Cap:	xxxx	xxxx	xxxx	xxxx	xxxx	xxxx	xxxx	xxxx	0.06	xxxx	xxxx	xxxx
Level Of Service Module:												
2Way95thQ:	xxxx	xxxx	xxxxx	xxxx	xxxx	xxxxx	xxxx	xxxx	0.2	xxxx	xxxx	xxxxx
Control Del:	xxxxx	xxxx	xxxxx	xxxxx	xxxx	xxxxx	xxxxx	xxxx	11.7	xxxxx	xxxx	xxxxx
LOS by Move:	*	*	*	*	*	*	*	*	B	*	*	*
Movement:	LT - LTR - RT	LT - LTR - RT	LT - LTR - RT	LT - LTR - RT	LT - LTR - RT	LT - LTR - RT	LT - LTR - RT	LT - LTR - RT		LT - LTR - RT	LT - LTR - RT	LT - LTR - RT
Shared Cap.:	xxxx	xxxx	xxxxx	xxxx	xxxx	xxxxx	xxxx	xxxx	xxxxx	xxxx	xxxx	xxxxx
SharedQueue:	xxxxx	xxxx	xxxxx	xxxxx	xxxx	xxxxx	xxxxx	xxxx	xxxxx	xxxxx	xxxx	xxxxx
Shrd ConDel:	xxxxx	xxxx	xxxxx	xxxxx	xxxx	xxxxx	xxxxx	xxxx	xxxxx	xxxxx	xxxx	xxxxx
Shared LOS:	*	*	*	*	*	*	*	*	*	*	*	*
ApproachDel:	xxxxxxx			xxxxxxx					11.7	xxxxxxx		
ApproachLOS:	*			*					B	*		

Note: Queue reported is the number of cars per lane.

San Antonio Village Phase III MTA
SJ21-2068
Background PM

Level Of Service Computation Report
2000 HCM Unsignalized (Future Volume Alternative)
Background PP PM

Intersection #8: Miller Avenue and San Antonio Road

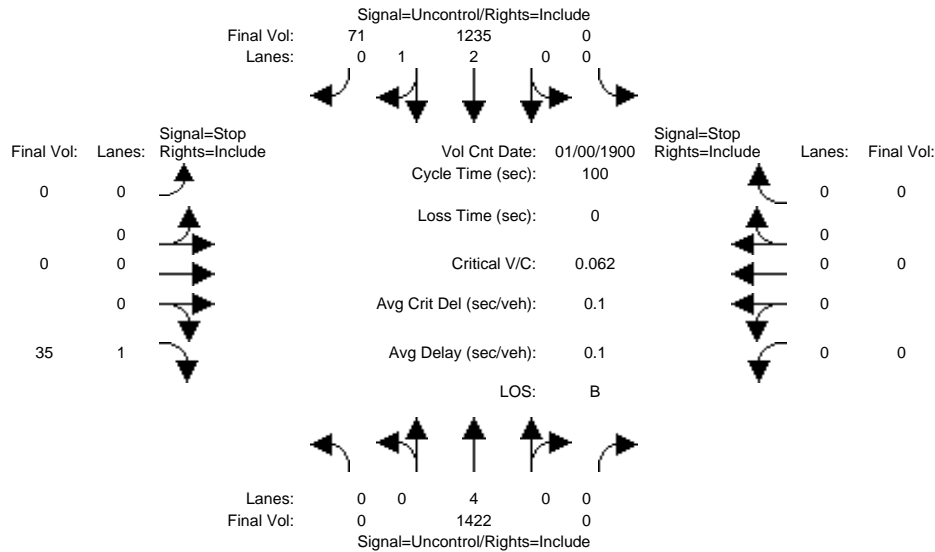

Approach:	North Bound			South Bound			East Bound			West Bound		
	L	T	R	L	T	R	L	T	R	L	T	R
Volume Module: >> Count Date: 0 Jan 1900 << 12:00:00 AM												
Base Vol:	0	1341	0	0	1147	71	0	0	35	0	0	0
Growth Adj:	1.00	1.00	1.00	1.00	1.00	1.00	1.00	1.00	1.00	1.00	1.00	1.00
Initial Bse:	0	1341	0	0	1147	71	0	0	35	0	0	0
Added Vol:	0	81	0	0	88	0	0	0	0	0	0	0
PasserByVol:	0	0	0	0	0	0	0	0	0	0	0	0
Initial Fut:	0	1422	0	0	1235	71	0	0	35	0	0	0
User Adj:	1.00	1.00	1.00	1.00	1.00	1.00	1.00	1.00	1.00	1.00	1.00	1.00
PHF Adj:	1.00	1.00	1.00	1.00	1.00	1.00	1.00	1.00	1.00	1.00	1.00	1.00
PHF Volume:	0	1422	0	0	1235	71	0	0	35	0	0	0
Reduct Vol:	0	0	0	0	0	0	0	0	0	0	0	0
FinalVolume:	0	1422	0	0	1235	71	0	0	35	0	0	0
Critical Gap Module:												
Critical Gp:	xxxxx	xxxx	xxxxx	xxxxx	xxxx	xxxxx	xxxxx	xxxx	6.9	xxxxx	xxxx	xxxxx
FollowUpTim:	xxxxx	xxxx	xxxxx	xxxxx	xxxx	xxxxx	xxxxx	xxxx	3.3	xxxxx	xxxx	xxxxx
Capacity Module:												
Cnflct Vol:	xxxx	xxxx	xxxxx	xxxx	xxxx	xxxxx	xxxx	xxxx	447	xxxx	xxxx	xxxxx
Potent Cap.:	xxxx	xxxx	xxxxx	xxxx	xxxx	xxxxx	xxxx	xxxx	564	xxxx	xxxx	xxxxx
Move Cap.:	xxxx	xxxx	xxxxx	xxxx	xxxx	xxxxx	xxxx	xxxx	564	xxxx	xxxx	xxxxx
Volume/Cap:	xxxx	xxxx	xxxx	xxxx	xxxx	xxxx	xxxx	xxxx	0.06	xxxx	xxxx	xxxx
Level Of Service Module:												
2Way95thQ:	xxxx	xxxx	xxxxx	xxxx	xxxx	xxxxx	xxxx	xxxx	0.2	xxxx	xxxx	xxxxx
Control Del:	xxxxx	xxxx	xxxxx	xxxxx	xxxx	xxxxx	xxxxx	xxxx	11.8	xxxxx	xxxx	xxxxx
LOS by Move:	*	*	*	*	*	*	*	*	B	*	*	*
Movement:	LT	LTR	RT	LT	LTR	RT	LT	LTR	RT	LT	LTR	RT
Shared Cap.:	xxxx	xxxx	xxxxx	xxxx	xxxx	xxxxx	xxxx	xxxx	xxxxx	xxxx	xxxx	xxxxx
SharedQueue:	xxxxx	xxxx	xxxxx	xxxxx	xxxx	xxxxx	xxxxx	xxxx	xxxxx	xxxxx	xxxx	xxxxx
Shrd ConDel:	xxxxx	xxxx	xxxxx	xxxxx	xxxx	xxxxx	xxxxx	xxxx	xxxxx	xxxxx	xxxx	xxxxx
Shared LOS:	*	*	*	*	*	*	*	*	*	*	*	*
ApproachDel:	xxxxxxx			xxxxxxx					11.8	xxxxxxx		
ApproachLOS:	*			*					B	*		

Note: Queue reported is the number of cars per lane.

San Antonio Village Phase III MTA
 SJ21-2068
 Background PM

Level Of Service Computation Report
 2000 HCM Operations (Future Volume Alternative)
 Background PM

Intersection #9: Nita Avenue and San Antonio Road

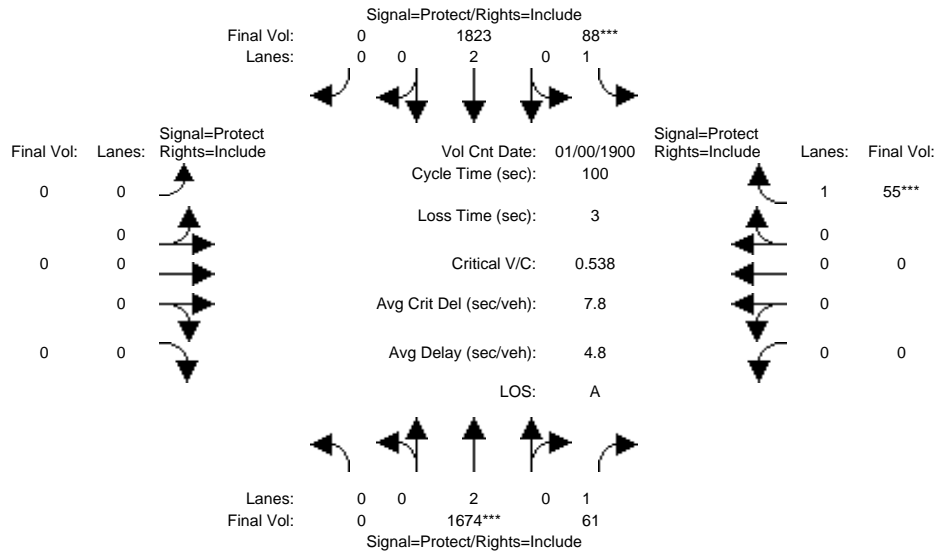

Approach:	North Bound			South Bound			East Bound			West Bound		
	L	T	R	L	T	R	L	T	R	L	T	R
Min. Green:	0	10	10	7	10	0	0	0	0	0	0	10
Y+R:	4.0	4.0	4.0	4.0	4.0	4.0	4.0	4.0	4.0	4.0	4.0	4.0
Volume Module: >> Count Date: 0 Jan 1900 << 12:00:00 AM												
Base Vol:	0	1635	61	88	1763	0	0	0	0	0	0	55
Growth Adj:	1.00	1.00	1.00	1.00	1.00	1.00	1.00	1.00	1.00	1.00	1.00	1.00
Initial Bse:	0	1635	61	88	1763	0	0	0	0	0	0	55
Added Vol:	0	39	0	0	60	0	0	0	0	0	0	0
PasserByVol:	0	0	0	0	0	0	0	0	0	0	0	0
Initial Fut:	0	1674	61	88	1823	0	0	0	0	0	0	55
User Adj:	1.00	1.00	1.00	1.00	1.00	1.00	1.00	1.00	1.00	1.00	1.00	1.00
PHF Adj:	1.00	1.00	1.00	1.00	1.00	1.00	1.00	1.00	1.00	1.00	1.00	1.00
PHF Volume:	0	1674	61	88	1823	0	0	0	0	0	0	55
Reduct Vol:	0	0	0	0	0	0	0	0	0	0	0	0
Reduced Vol:	0	1674	61	88	1823	0	0	0	0	0	0	55
PCE Adj:	1.00	1.00	1.00	1.00	1.00	1.00	1.00	1.00	1.00	1.00	1.00	1.00
MLF Adj:	1.00	1.00	1.00	1.00	1.00	1.00	1.00	1.00	1.00	1.00	1.00	1.00
FinalVolume:	0	1674	61	88	1823	0	0	0	0	0	0	55
Saturation Flow Module:												
Sat/Lane:	1900	1900	1900	1900	1900	1900	1900	1900	1900	1900	1900	1900
Adjustment:	0.92	1.00	0.92	0.92	1.00	0.92	0.92	1.00	0.92	0.92	1.00	0.92
Lanes:	0.00	2.00	1.00	1.00	2.00	0.00	0.00	0.00	0.00	0.00	0.00	1.00
Final Sat.:	0	3800	1750	1750	3800	0	0	0	0	0	0	1750
Capacity Analysis Module:												
Vol/Sat:	0.00	0.44	0.03	0.05	0.48	0.00	0.00	0.00	0.00	0.00	0.00	0.03
Crit Moves:	****			****						****		
Green Time:	0.0	78.1	78.1	8.9	87.0	0.0	0.0	0.0	0.0	0.0	0.0	10.0
Volume/Cap:	0.00	0.56	0.04	0.56	0.55	0.00	0.00	0.00	0.00	0.00	0.00	0.31
Uniform Del:	0.0	4.3	2.5	43.7	1.6	0.0	0.0	0.0	0.0	0.0	0.0	41.8
IncrcmntDel:	0.0	0.3	0.0	4.7	0.2	0.0	0.0	0.0	0.0	0.0	0.0	1.0
InitQueuDel:	0.0	0.0	0.0	0.0	0.0	0.0	0.0	0.0	0.0	0.0	0.0	0.0
Delay Adj:	0.00	1.00	1.00	1.00	1.00	0.00	0.00	0.00	0.00	0.00	0.00	1.00
Delay/Veh:	0.0	4.5	2.5	48.4	1.8	0.0	0.0	0.0	0.0	0.0	0.0	42.8
User DelAdj:	1.00	1.00	1.00	1.00	1.00	1.00	1.00	1.00	1.00	1.00	1.00	1.00
AdjDel/Veh:	0.0	4.5	2.5	48.4	1.8	0.0	0.0	0.0	0.0	0.0	0.0	42.8
LOS by Move:	A	A	A	D	A	A	A	A	A	A	A	D
HCM2kAvgQ:	0	9	0	3	7	0	0	0	0	0	0	2

Note: Queue reported is the number of cars per lane.

San Antonio Village Phase III MTA
 SJ21-2068
 Background PM

Level Of Service Computation Report
 2000 HCM Operations (Future Volume Alternative)
 Background PP PM

Intersection #9: Nita Avenue and San Antonio Road

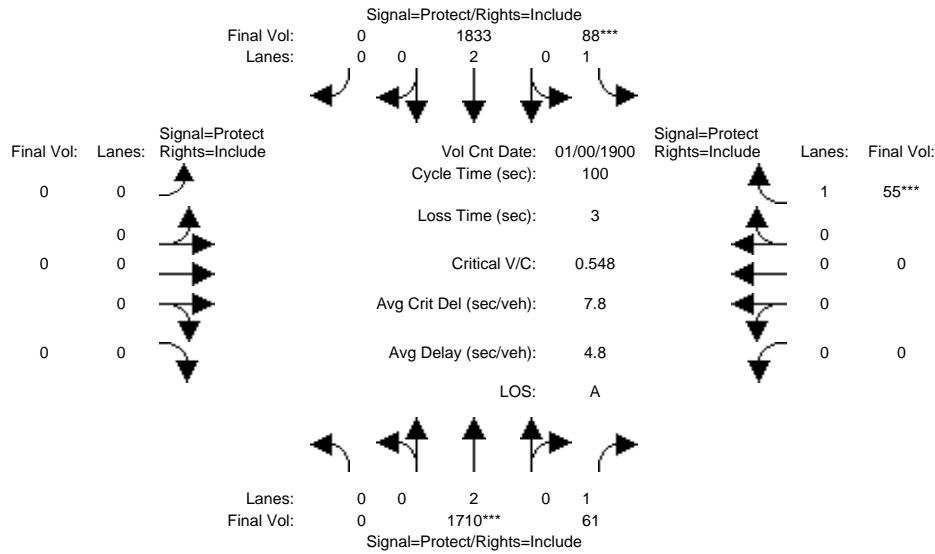

Approach:	North Bound			South Bound			East Bound			West Bound		
	L	T	R	L	T	R	L	T	R	L	T	R
Min. Green:	0	10	10	7	10	0	0	0	0	0	0	10
Y+R:	4.0	4.0	4.0	4.0	4.0	4.0	4.0	4.0	4.0	4.0	4.0	4.0
Volume Module: >> Count Date: 0 Jan 1900 << 12:00:00 AM												
Base Vol:	0	1635	61	88	1763	0	0	0	0	0	0	55
Growth Adj:	1.00	1.00	1.00	1.00	1.00	1.00	1.00	1.00	1.00	1.00	1.00	1.00
Initial Bse:	0	1635	61	88	1763	0	0	0	0	0	0	55
Added Vol:	0	75	0	0	70	0	0	0	0	0	0	0
PasserByVol:	0	0	0	0	0	0	0	0	0	0	0	0
Initial Fut:	0	1710	61	88	1833	0	0	0	0	0	0	55
User Adj:	1.00	1.00	1.00	1.00	1.00	1.00	1.00	1.00	1.00	1.00	1.00	1.00
PHF Adj:	1.00	1.00	1.00	1.00	1.00	1.00	1.00	1.00	1.00	1.00	1.00	1.00
PHF Volume:	0	1710	61	88	1833	0	0	0	0	0	0	55
Reduct Vol:	0	0	0	0	0	0	0	0	0	0	0	0
Reduced Vol:	0	1710	61	88	1833	0	0	0	0	0	0	55
PCE Adj:	1.00	1.00	1.00	1.00	1.00	1.00	1.00	1.00	1.00	1.00	1.00	1.00
MLF Adj:	1.00	1.00	1.00	1.00	1.00	1.00	1.00	1.00	1.00	1.00	1.00	1.00
FinalVolume:	0	1710	61	88	1833	0	0	0	0	0	0	55
Saturation Flow Module:												
Sat/Lane:	1900	1900	1900	1900	1900	1900	1900	1900	1900	1900	1900	1900
Adjustment:	0.92	1.00	0.92	0.92	1.00	0.92	0.92	1.00	0.92	0.92	1.00	0.92
Lanes:	0.00	2.00	1.00	1.00	2.00	0.00	0.00	0.00	0.00	0.00	0.00	1.00
Final Sat.:	0	3800	1750	1750	3800	0	0	0	0	0	0	1750
Capacity Analysis Module:												
Vol/Sat:	0.00	0.45	0.03	0.05	0.48	0.00	0.00	0.00	0.00	0.00	0.00	0.03
Crit Moves:	****			****						****		
Green Time:	0.0	78.3	78.3	8.7	87.0	0.0	0.0	0.0	0.0	0.0	0.0	10.0
Volume/Cap:	0.00	0.58	0.04	0.58	0.55	0.00	0.00	0.00	0.00	0.00	0.00	0.31
Delay/Veh:	0.0	4.6	2.5	49.1	1.8	0.0	0.0	0.0	0.0	0.0	0.0	42.8
User DelAdj:	1.00	1.00	1.00	1.00	1.00	1.00	1.00	1.00	1.00	1.00	1.00	1.00
AdjDel/Veh:	0.0	4.6	2.5	49.1	1.8	0.0	0.0	0.0	0.0	0.0	0.0	42.8
LOS by Move:	A	A	A	D	A	A	A	A	A	A	A	D
HCM2kAvgQ:	0	10	0	3	7	0	0	0	0	0	0	2

Note: Queue reported is the number of cars per lane.

San Antonio Village Phase III MTA
 SJ21-2068
 Background PM

Level Of Service Computation Report
 2000 HCM Operations (Future Volume Alternative)
 Background PM

Intersection #10: California Street and San Antonio Road

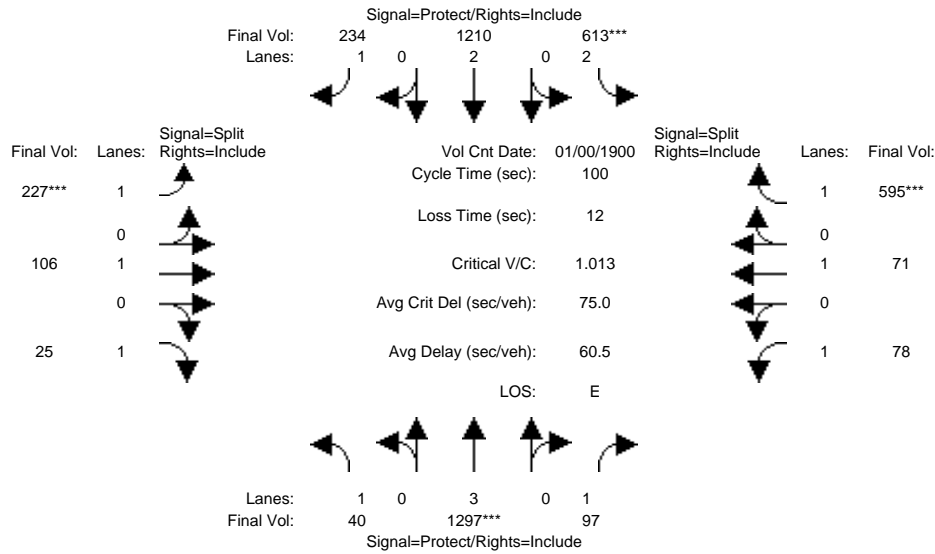

Approach:	North Bound			South Bound			East Bound			West Bound		
	L	T	R	L	T	R	L	T	R	L	T	R
Min. Green:	7	10	10	7	10	10	10	10	10	10	10	10
Y+R:	4.0	4.0	4.0	4.0	4.0	4.0	4.0	4.0	4.0	4.0	4.0	4.0

Volume Module:	>>	Count	Date:	0	Jan	1900	<<	12:	00:00	AM
Base Vol:	40	1232	96	613	1157	234	227	106	25	76 71 591
Growth Adj:	1.00	1.00	1.00	1.00	1.00	1.00	1.00	1.00	1.00	1.00 1.00 1.00
Initial Bse:	40	1232	96	613	1157	234	227	106	25	76 71 591
Added Vol:	0	65	1	0	53	0	0	0	0	2 0 4
PasserByVol:	0	0	0	0	0	0	0	0	0	0 0 0
Initial Fut:	40	1297	97	613	1210	234	227	106	25	78 71 595
User Adj:	1.00	1.00	1.00	1.00	1.00	1.00	1.00	1.00	1.00	1.00 1.00 1.00
PHF Adj:	1.00	1.00	1.00	1.00	1.00	1.00	1.00	1.00	1.00	1.00 1.00 1.00
PHF Volume:	40	1297	97	613	1210	234	227	106	25	78 71 595
Reduct Vol:	0	0	0	0	0	0	0	0	0	0 0 0
Reduced Vol:	40	1297	97	613	1210	234	227	106	25	78 71 595
PCE Adj:	1.00	1.00	1.00	1.00	1.00	1.00	1.00	1.00	1.00	1.00 1.00 1.00
MLF Adj:	1.00	1.00	1.00	1.00	1.00	1.00	1.00	1.00	1.00	1.00 1.00 1.00
FinalVolume:	40	1297	97	613	1210	234	227	106	25	78 71 595

Saturation Flow Module:	1900			1900			1900			1900		
Sat/Lane:	1900	1900	1900	1900	1900	1900	1900	1900	1900	1900	1900	
Adjustment:	0.92	1.00	0.92	0.83	1.00	0.92	0.92	1.00	0.92	0.92	1.00	
Lanes:	1.00	3.00	1.00	2.00	2.00	1.00	1.00	1.00	1.00	1.00	1.00	
Final Sat.:	1750	5700	1750	3150	3800	1750	1750	1900	1750	1750	1900	

Capacity Analysis Module:	0.02 0.23 0.06			0.19 0.32 0.13			0.13 0.06 0.01			0.04 0.04 0.34		
Vol/Sat:	0.02	0.23	0.06	0.19	0.32	0.13	0.13	0.06	0.01	0.04	0.04	0.34
Crit Moves:	****	****	****	****	****	****	****	****	****	****	****	****
Green Time:	7.5	22.5	22.5	19.2	34.1	34.1	12.8	12.8	12.8	33.5	33.5	33.5
Volume/Cap:	0.30	1.01	0.25	1.01	0.93	0.39	1.01	0.44	0.11	0.13	0.11	1.01
Uniform Del:	43.8	38.8	31.8	40.4	31.8	25.0	43.6	40.3	38.6	23.1	22.9	33.2
IncrcmntDel:	1.3	28.5	0.3	40.0	12.2	0.4	63.6	1.3	0.2	0.1	0.1	40.5
InitQueuDel:	0.0	0.0	0.0	0.0	0.0	0.0	0.0	0.0	0.0	0.0	0.0	0.0
Delay Adj:	1.00	1.00	1.00	1.00	1.00	1.00	1.00	1.00	1.00	1.00	1.00	1.00
Delay/Veh:	45.1	67.3	32.2	80.4	44.0	25.5	107.2	41.5	38.8	23.2	23.0	73.8
User DelAdj:	1.00	1.00	1.00	1.00	1.00	1.00	1.00	1.00	1.00	1.00	1.00	1.00
AdjDel/Veh:	45.1	67.3	32.2	80.4	44.0	25.5	107.2	41.5	38.8	23.2	23.0	73.8
LOS by Move:	D	E	C-	F	D	C	F	D	D+	C	C	E
HCM2kAvgQ:	1	17	3	14	20	6	13	3	1	2	1	25

Note: Queue reported is the number of cars per lane.

San Antonio Village Phase III MTA
 SJ21-2068
 Background PM

Level Of Service Computation Report
 2000 HCM Operations (Future Volume Alternative)
 Background PP PM

Intersection #10: California Street and San Antonio Road

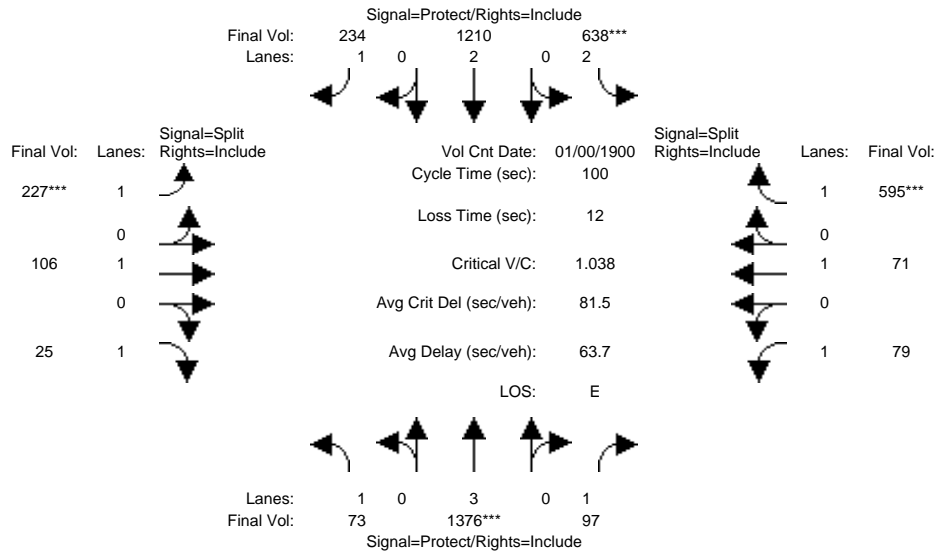

Approach:	North Bound			South Bound			East Bound			West Bound		
Movement:	L	T	R	L	T	R	L	T	R	L	T	R
Min. Green:	7	10	10	7	10	10	10	10	10	10	10	10
Y+R:	4.0	4.0	4.0	4.0	4.0	4.0	4.0	4.0	4.0	4.0	4.0	4.0
Volume Module: >> Count Date: 0 Jan 1900 << 12:00:00 AM												
Base Vol:	40	1232	96	613	1157	234	227	106	25	76	71	591
Growth Adj:	1.00	1.00	1.00	1.00	1.00	1.00	1.00	1.00	1.00	1.00	1.00	1.00
Initial Bse:	40	1232	96	613	1157	234	227	106	25	76	71	591
Added Vol:	33	144	1	25	53	0	0	0	0	3	0	4
PasserByVol:	0	0	0	0	0	0	0	0	0	0	0	0
Initial Fut:	73	1376	97	638	1210	234	227	106	25	79	71	595
User Adj:	1.00	1.00	1.00	1.00	1.00	1.00	1.00	1.00	1.00	1.00	1.00	1.00
PHF Adj:	1.00	1.00	1.00	1.00	1.00	1.00	1.00	1.00	1.00	1.00	1.00	1.00
PHF Volume:	73	1376	97	638	1210	234	227	106	25	79	71	595
Reduct Vol:	0	0	0	0	0	0	0	0	0	0	0	0
Reduced Vol:	73	1376	97	638	1210	234	227	106	25	79	71	595
PCE Adj:	1.00	1.00	1.00	1.00	1.00	1.00	1.00	1.00	1.00	1.00	1.00	1.00
MLF Adj:	1.00	1.00	1.00	1.00	1.00	1.00	1.00	1.00	1.00	1.00	1.00	1.00
FinalVolume:	73	1376	97	638	1210	234	227	106	25	79	71	595
Saturation Flow Module:												
Sat/Lane:	1900	1900	1900	1900	1900	1900	1900	1900	1900	1900	1900	1900
Adjustment:	0.92	1.00	0.92	0.83	1.00	0.92	0.92	1.00	0.92	0.92	1.00	0.92
Lanes:	1.00	3.00	1.00	2.00	2.00	1.00	1.00	1.00	1.00	1.00	1.00	1.00
Final Sat.:	1750	5700	1750	3150	3800	1750	1750	1900	1750	1750	1900	1750
Capacity Analysis Module:												
Vol/Sat:	0.04	0.24	0.06	0.20	0.32	0.13	0.13	0.06	0.01	0.05	0.04	0.34
Crit Moves:	****			****			****			****		
Green Time:	7.7	23.3	23.3	19.5	35.1	35.1	12.5	12.5	12.5	32.7	32.7	32.7
Volume/Cap:	0.54	1.04	0.24	1.04	0.91	0.38	1.04	0.45	0.11	0.14	0.11	1.04
Delay/Veh:	48.9	73.6	31.5	86.8	40.3	24.7	115.0	41.9	39.1	23.8	23.6	81.5
User DelAdj:	1.00	1.00	1.00	1.00	1.00	1.00	1.00	1.00	1.00	1.00	1.00	1.00
AdjDel/Veh:	48.9	73.6	31.5	86.8	40.3	24.7	115.0	41.9	39.1	23.8	23.6	81.5
LOS by Move:	D	E	C	F	D	C	F	D	D	C	C	F
HCM2kAvgQ:	2	19	3	16	19	6	13	3	1	2	1	26

Note: Queue reported is the number of cars per lane.

San Antonio Village Phase III MTA
 SJ21-2068
 Background PM

Level Of Service Computation Report
 2000 HCM Operations (Future Volume Alternative)
 Background PM

Intersection #11: California Street and Pacchetti Way

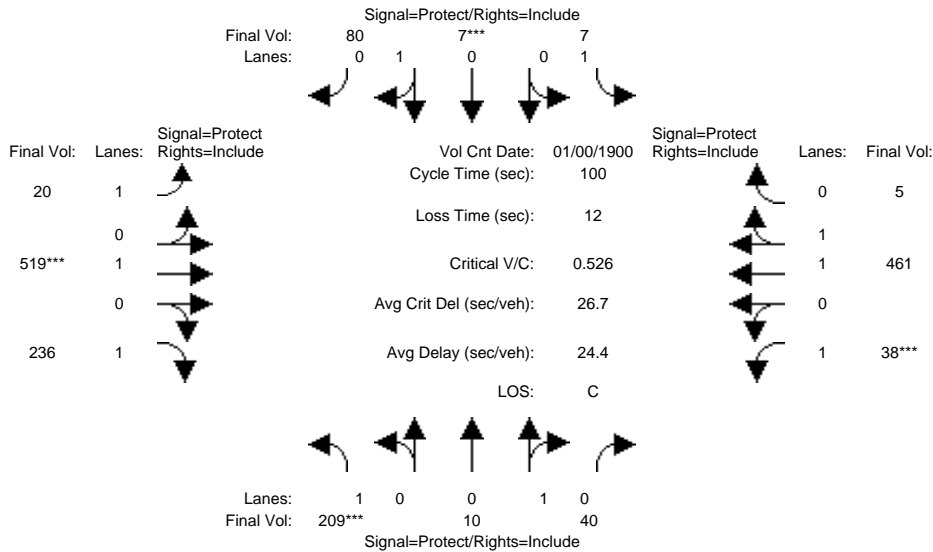

Approach:	North Bound			South Bound			East Bound			West Bound		
	L	T	R	L	T	R	L	T	R	L	T	R
Min. Green:	7	10	10	7	10	10	7	10	10	7	10	10
Y+R:	4.0	4.0	4.0	4.0	4.0	4.0	4.0	4.0	4.0	4.0	4.0	4.0

Volume Module:	>> Count Date: 0 Jan 1900 << 12:00:00 AM											
Base Vol:	209	10	40	7	7	80	20	518	236	38	455	5
Growth Adj:	1.00	1.00	1.00	1.00	1.00	1.00	1.00	1.00	1.00	1.00	1.00	1.00
Initial Bse:	209	10	40	7	7	80	20	518	236	38	455	5
Added Vol:	0	0	0	0	0	0	0	1	0	0	6	0
PasserByVol:	0	0	0	0	0	0	0	0	0	0	0	0
Initial Fut:	209	10	40	7	7	80	20	519	236	38	461	5
User Adj:	1.00	1.00	1.00	1.00	1.00	1.00	1.00	1.00	1.00	1.00	1.00	1.00
PHF Adj:	1.00	1.00	1.00	1.00	1.00	1.00	1.00	1.00	1.00	1.00	1.00	1.00
PHF Volume:	209	10	40	7	7	80	20	519	236	38	461	5
Reduct Vol:	0	0	0	0	0	0	0	0	0	0	0	0
Reduced Vol:	209	10	40	7	7	80	20	519	236	38	461	5
PCE Adj:	1.00	1.00	1.00	1.00	1.00	1.00	1.00	1.00	1.00	1.00	1.00	1.00
MLF Adj:	1.00	1.00	1.00	1.00	1.00	1.00	1.00	1.00	1.00	1.00	1.00	1.00
FinalVolume:	209	10	40	7	7	80	20	519	236	38	461	5

Saturation Flow Module:												
Sat/Lane:	1900	1900	1900	1900	1900	1900	1900	1900	1900	1900	1900	1900
Adjustment:	0.92	0.95	0.95	0.92	0.95	0.95	0.92	1.00	0.92	0.92	0.97	0.95
Lanes:	1.00	0.20	0.80	1.00	0.08	0.92	1.00	1.00	1.00	1.00	1.98	0.02
Final Sat.:	1750	360	1440	1750	145	1655	1750	1900	1750	1750	3660	40

Capacity Analysis Module:												
Vol/Sat:	0.12	0.03	0.03	0.00	0.05	0.05	0.01	0.27	0.13	0.02	0.13	0.13
Crit Moves:	****			****			****			****		
Green Time:	21.6	18.6	18.6	13.0	10.0	10.0	20.1	49.4	49.4	7.0	36.3	36.3
Volume/Cap:	0.55	0.15	0.15	0.03	0.48	0.48	0.06	0.55	0.27	0.31	0.35	0.35
Uniform Del:	34.9	34.1	34.1	38.0	42.6	42.6	32.2	17.6	14.8	44.2	23.2	23.2
IncrcmntDel:	1.8	0.2	0.2	0.1	2.0	2.0	0.1	0.7	0.2	1.4	0.2	0.2
InitQueuDel:	0.0	0.0	0.0	0.0	0.0	0.0	0.0	0.0	0.0	0.0	0.0	0.0
Delay Adj:	1.00	1.00	1.00	1.00	1.00	1.00	1.00	1.00	1.00	1.00	1.00	1.00
Delay/Veh:	36.7	34.3	34.3	38.0	44.6	44.6	32.3	18.3	15.0	45.7	23.4	23.4
User DelAdj:	1.00	1.00	1.00	1.00	1.00	1.00	1.00	1.00	1.00	1.00	1.00	1.00
AdjDel/Veh:	36.7	34.3	34.3	38.0	44.6	44.6	32.3	18.3	15.0	45.7	23.4	23.4
LOS by Move:	D+	C-	C-	D+	D	D	C-	B-	B	D	C	C
HCM2kAvgQ:	7	1	1	0	3	3	1	11	4	1	5	5

Note: Queue reported is the number of cars per lane.

San Antonio Village Phase III MTA
 SJ21-2068
 Background PM

Level Of Service Computation Report
 2000 HCM Operations (Future Volume Alternative)
 Background PP PM

Intersection #11: California Street and Pacchetti Way

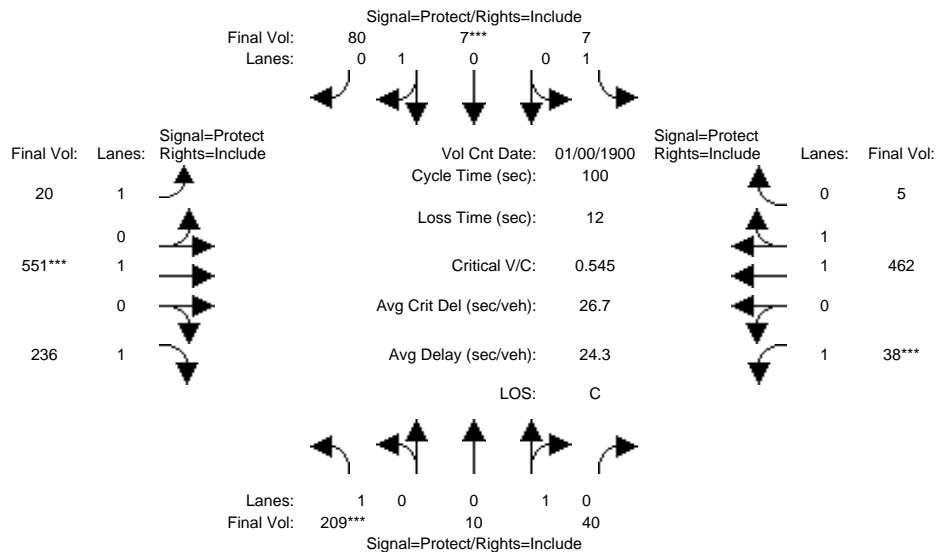

Approach:	North Bound			South Bound			East Bound			West Bound		
	L	T	R	L	T	R	L	T	R	L	T	R
Min. Green:	7	10	10	7	10	10	7	10	10	7	10	10
Y+R:	4.0	4.0	4.0	4.0	4.0	4.0	4.0	4.0	4.0	4.0	4.0	4.0
Volume Module: >> Count Date: 0 Jan 1900 << 12:00:00 AM												
Base Vol:	209	10	40	7	7	80	20	518	236	38	455	5
Growth Adj:	1.00	1.00	1.00	1.00	1.00	1.00	1.00	1.00	1.00	1.00	1.00	1.00
Initial Bse:	209	10	40	7	7	80	20	518	236	38	455	5
Added Vol:	0	0	0	0	0	0	0	33	0	0	7	0
PasserByVol:	0	0	0	0	0	0	0	0	0	0	0	0
Initial Fut:	209	10	40	7	7	80	20	551	236	38	462	5
User Adj:	1.00	1.00	1.00	1.00	1.00	1.00	1.00	1.00	1.00	1.00	1.00	1.00
PHF Adj:	1.00	1.00	1.00	1.00	1.00	1.00	1.00	1.00	1.00	1.00	1.00	1.00
PHF Volume:	209	10	40	7	7	80	20	551	236	38	462	5
Reduct Vol:	0	0	0	0	0	0	0	0	0	0	0	0
Reduced Vol:	209	10	40	7	7	80	20	551	236	38	462	5
PCE Adj:	1.00	1.00	1.00	1.00	1.00	1.00	1.00	1.00	1.00	1.00	1.00	1.00
MLF Adj:	1.00	1.00	1.00	1.00	1.00	1.00	1.00	1.00	1.00	1.00	1.00	1.00
FinalVolume:	209	10	40	7	7	80	20	551	236	38	462	5
Saturation Flow Module:												
Sat/Lane:	1900	1900	1900	1900	1900	1900	1900	1900	1900	1900	1900	1900
Adjustment:	0.92	0.95	0.95	0.92	0.95	0.95	0.92	1.00	0.92	0.92	0.97	0.95
Lanes:	1.00	0.20	0.80	1.00	0.08	0.92	1.00	1.00	1.00	1.00	1.98	0.02
Final Sat.:	1750	360	1440	1750	145	1655	1750	1900	1750	1750	3660	40
Capacity Analysis Module:												
Vol/Sat:	0.12	0.03	0.03	0.00	0.05	0.05	0.01	0.29	0.13	0.02	0.13	0.13
Crit Moves:	****				****			****		****		
Green Time:	20.7	18.1	18.1	12.6	10.0	10.0	20.4	50.3	50.3	7.0	36.9	36.9
Volume/Cap:	0.58	0.15	0.15	0.03	0.48	0.48	0.06	0.58	0.27	0.31	0.34	0.34
Delay/Veh:	38.0	34.7	34.7	38.4	44.6	44.6	32.1	18.3	14.4	45.7	23.0	23.0
User DelAdj:	1.00	1.00	1.00	1.00	1.00	1.00	1.00	1.00	1.00	1.00	1.00	1.00
AdjDel/Veh:	38.0	34.7	34.7	38.4	44.6	44.6	32.1	18.3	14.4	45.7	23.0	23.0
LOS by Move:	D+	C-	C-	D+	D	D	C-	B-	B	D	C+	C+
HCM2kAvgQ:	7	1	1	0	3	3	1	12	4	1	5	5

Note: Queue reported is the number of cars per lane.

San Antonio Village Phase III MTA
 SJ21-2068
 Background PM

Level Of Service Computation Report
 2000 HCM Operations (Future Volume Alternative)
 Background PM

Intersection #12: California Street and Showers Drive

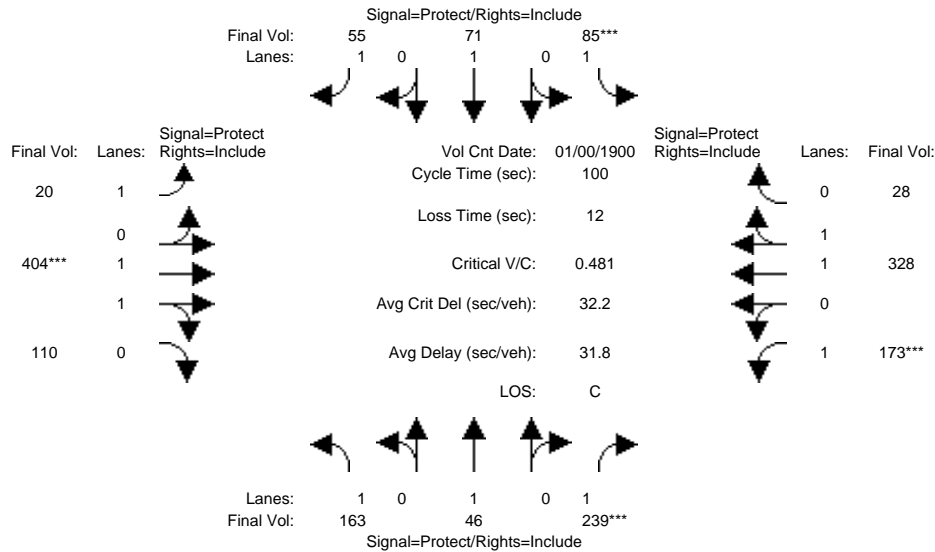

Approach:	North Bound			South Bound			East Bound			West Bound		
Movement:	L	T	R	L	T	R	L	T	R	L	T	R
Min. Green:	7	10	10	7	10	10	7	10	10	7	10	10
Y+R:	4.0	4.0	4.0	4.0	4.0	4.0	4.0	4.0	4.0	4.0	4.0	4.0
Volume Module: >> Count Date: 0 Jan 1900 << 12:00:00 AM												
Base Vol:	163	46	239	85	71	55	20	403	110	173	322	28
Growth Adj:	1.00	1.00	1.00	1.00	1.00	1.00	1.00	1.00	1.00	1.00	1.00	1.00
Initial Bse:	163	46	239	85	71	55	20	403	110	173	322	28
Added Vol:	0	0	0	0	0	0	0	1	0	0	6	0
PasserByVol:	0	0	0	0	0	0	0	0	0	0	0	0
Initial Fut:	163	46	239	85	71	55	20	404	110	173	328	28
User Adj:	1.00	1.00	1.00	1.00	1.00	1.00	1.00	1.00	1.00	1.00	1.00	1.00
PHF Adj:	1.00	1.00	1.00	1.00	1.00	1.00	1.00	1.00	1.00	1.00	1.00	1.00
PHF Volume:	163	46	239	85	71	55	20	404	110	173	328	28
Reduct Vol:	0	0	0	0	0	0	0	0	0	0	0	0
Reduced Vol:	163	46	239	85	71	55	20	404	110	173	328	28
PCE Adj:	1.00	1.00	1.00	1.00	1.00	1.00	1.00	1.00	1.00	1.00	1.00	1.00
MLF Adj:	1.00	1.00	1.00	1.00	1.00	1.00	1.00	1.00	1.00	1.00	1.00	1.00
Final Volume:	163	46	239	85	71	55	20	404	110	173	328	28
Saturation Flow Module:												
Sat/Lane:	1900	1900	1900	1900	1900	1900	1900	1900	1900	1900	1900	1900
Adjustment:	0.92	1.00	0.92	0.92	1.00	0.92	0.92	0.98	0.95	0.92	0.98	0.95
Lanes:	1.00	1.00	1.00	1.00	1.00	1.00	1.00	1.56	0.44	1.00	1.84	0.16
Final Sat.:	1750	1900	1750	1750	1900	1750	1750	2908	792	1750	3409	291
Capacity Analysis Module:												
Vol/Sat:	0.09	0.02	0.14	0.05	0.04	0.03	0.01	0.14	0.14	0.10	0.10	0.10
Crit Moves:			****	****				****		****		
Green Time:	18.6	28.4	28.4	10.1	19.9	19.9	20.4	28.9	28.9	20.6	29.1	29.1
Volume/Cap:	0.50	0.09	0.48	0.48	0.19	0.16	0.06	0.48	0.48	0.48	0.33	0.33
Uniform Del:	36.6	26.3	29.7	42.5	33.3	33.1	32.1	29.3	29.3	35.0	27.8	27.8
IncrementDel:	1.2	0.1	0.7	2.1	0.2	0.2	0.1	0.3	0.3	1.0	0.2	0.2
InitQueueDel:	0.0	0.0	0.0	0.0	0.0	0.0	0.0	0.0	0.0	0.0	0.0	0.0
Delay Adj:	1.00	1.00	1.00	1.00	1.00	1.00	1.00	1.00	1.00	1.00	1.00	1.00
Delay/Veh:	37.8	26.3	30.4	44.5	33.5	33.3	32.1	29.7	29.7	36.0	28.0	28.0
User DelAdj:	1.00	1.00	1.00	1.00	1.00	1.00	1.00	1.00	1.00	1.00	1.00	1.00
AdjDel/Veh:	37.8	26.3	30.4	44.5	33.5	33.3	32.1	29.7	29.7	36.0	28.0	28.0
LOS by Move:	D+	C	C	D	C-	C-	C-	C	C	D+	C	C
HCM2kAvgQ:	5	1	6	3	2	2	1	6	6	5	4	4

Note: Queue reported is the number of cars per lane.

San Antonio Village Phase III MTA
 SJ21-2068
 Background PM

Level Of Service Computation Report
 2000 HCM Operations (Future Volume Alternative)
 Background PP PM

Intersection #12: California Street and Showers Drive

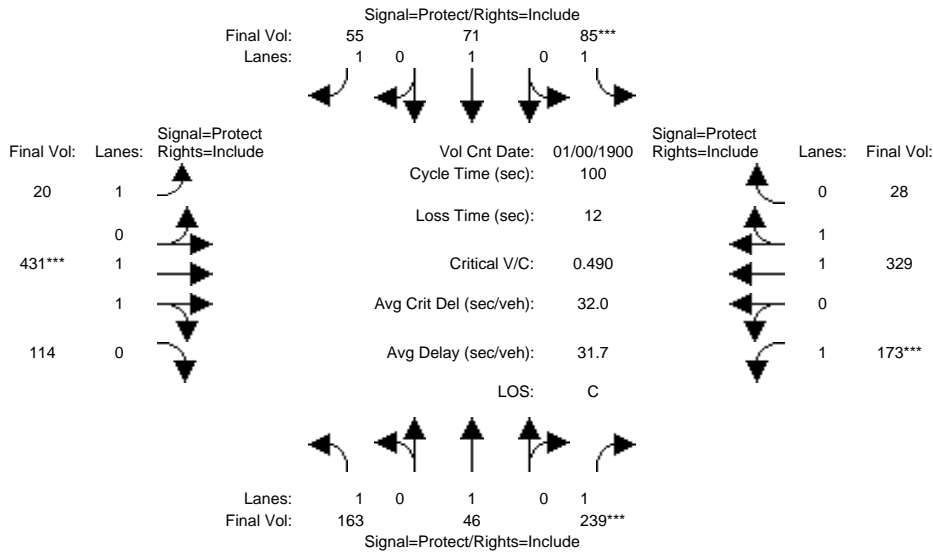

Approach:	North Bound			South Bound			East Bound			West Bound		
Movement:	L	T	R	L	T	R	L	T	R	L	T	R
Min. Green:	7	10	10	7	10	10	7	10	10	7	10	10
Y+R:	4.0	4.0	4.0	4.0	4.0	4.0	4.0	4.0	4.0	4.0	4.0	4.0
Volume Module: >> Count Date: 0 Jan 1900 << 12:00:00 AM												
Base Vol:	163	46	239	85	71	55	20	403	110	173	322	28
Growth Adj:	1.00	1.00	1.00	1.00	1.00	1.00	1.00	1.00	1.00	1.00	1.00	1.00
Initial Bse:	163	46	239	85	71	55	20	403	110	173	322	28
Added Vol:	0	0	0	0	0	0	0	28	4	0	7	0
PasserByVol:	0	0	0	0	0	0	0	0	0	0	0	0
Initial Fut:	163	46	239	85	71	55	20	431	114	173	329	28
User Adj:	1.00	1.00	1.00	1.00	1.00	1.00	1.00	1.00	1.00	1.00	1.00	1.00
PHF Adj:	1.00	1.00	1.00	1.00	1.00	1.00	1.00	1.00	1.00	1.00	1.00	1.00
PHF Volume:	163	46	239	85	71	55	20	431	114	173	329	28
Reduct Vol:	0	0	0	0	0	0	0	0	0	0	0	0
Reduced Vol:	163	46	239	85	71	55	20	431	114	173	329	28
PCE Adj:	1.00	1.00	1.00	1.00	1.00	1.00	1.00	1.00	1.00	1.00	1.00	1.00
MLF Adj:	1.00	1.00	1.00	1.00	1.00	1.00	1.00	1.00	1.00	1.00	1.00	1.00
Final Volume:	163	46	239	85	71	55	20	431	114	173	329	28
Saturation Flow Module:												
Sat/Lane:	1900	1900	1900	1900	1900	1900	1900	1900	1900	1900	1900	1900
Adjustment:	0.92	1.00	0.92	0.92	1.00	0.92	0.92	0.98	0.95	0.92	0.98	0.95
Lanes:	1.00	1.00	1.00	1.00	1.00	1.00	1.00	1.57	0.43	1.00	1.84	0.16
Final Sat.:	1750	1900	1750	1750	1900	1750	1750	2925	774	1750	3410	290
Capacity Analysis Module:												
Vol/Sat:	0.09	0.02	0.14	0.05	0.04	0.03	0.01	0.15	0.15	0.10	0.10	0.10
Crit Moves:			****	****				****		****		
Green Time:	18.2	27.9	27.9	9.9	19.6	19.6	20.7	30.1	30.1	20.2	29.5	29.5
Volume/Cap:	0.51	0.09	0.49	0.49	0.19	0.16	0.06	0.49	0.49	0.49	0.33	0.33
Delay/Veh:	38.3	26.7	30.9	44.8	33.9	33.6	31.9	29.0	29.0	36.4	27.6	27.6
User DelAdj:	1.00	1.00	1.00	1.00	1.00	1.00	1.00	1.00	1.00	1.00	1.00	1.00
AdjDel/Veh:	38.3	26.7	30.9	44.8	33.9	33.6	31.9	29.0	29.0	36.4	27.6	27.6
LOS by Move:	D+	C	C	D	C-	C-	C	C	C	D+	C	C
HCM2kAvgQ:	5	1	6	3	2	2	1	7	7	5	4	4

Note: Queue reported is the number of cars per lane.

San Antonio Village Phase III MTA
 SJ21-2068
 Background PM

Level Of Service Computation Report
 2000 HCM Operations (Future Volume Alternative)
 Background PM

Intersection #13: California Street and Ortega Avenue

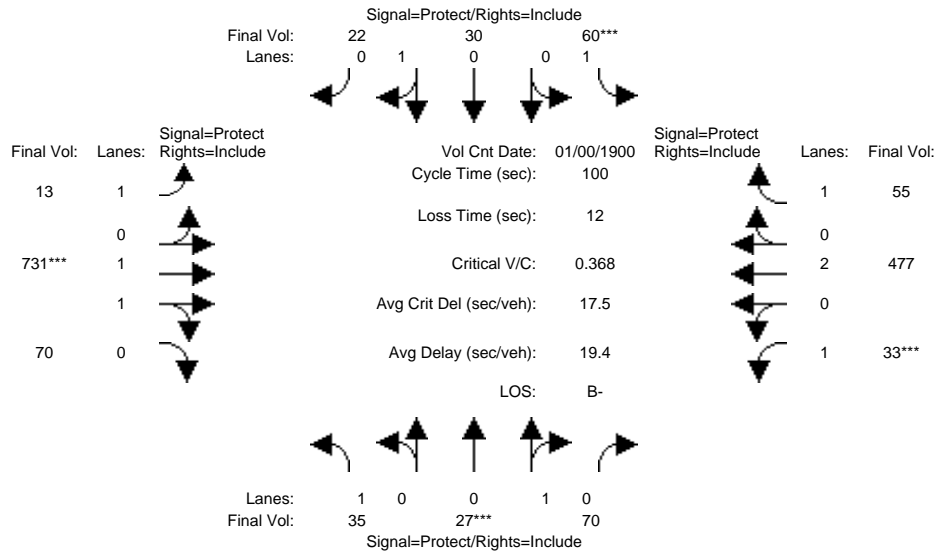

Approach:	North Bound			South Bound			East Bound			West Bound		
Movement:	L	T	R	L	T	R	L	T	R	L	T	R
Min. Green:	7	10	10	7	10	10	7	10	10	7	10	10
Y+R:	4.0	4.0	4.0	4.0	4.0	4.0	4.0	4.0	4.0	4.0	4.0	4.0
Volume Module: >> Count Date: 0 Jan 1900 << 12:00:00 AM												
Base Vol:	35	27	70	60	30	22	13	730	70	33	471	55
Growth Adj:	1.00	1.00	1.00	1.00	1.00	1.00	1.00	1.00	1.00	1.00	1.00	1.00
Initial Bse:	35	27	70	60	30	22	13	730	70	33	471	55
Added Vol:	0	0	0	0	0	0	0	1	0	0	6	0
PasserByVol:	0	0	0	0	0	0	0	0	0	0	0	0
Initial Fut:	35	27	70	60	30	22	13	731	70	33	477	55
User Adj:	1.00	1.00	1.00	1.00	1.00	1.00	1.00	1.00	1.00	1.00	1.00	1.00
PHF Adj:	1.00	1.00	1.00	1.00	1.00	1.00	1.00	1.00	1.00	1.00	1.00	1.00
PHF Volume:	35	27	70	60	30	22	13	731	70	33	477	55
Reduct Vol:	0	0	0	0	0	0	0	0	0	0	0	0
Reduced Vol:	35	27	70	60	30	22	13	731	70	33	477	55
PCE Adj:	1.00	1.00	1.00	1.00	1.00	1.00	1.00	1.00	1.00	1.00	1.00	1.00
MLF Adj:	1.00	1.00	1.00	1.00	1.00	1.00	1.00	1.00	1.00	1.00	1.00	1.00
Final Volume:	35	27	70	60	30	22	13	731	70	33	477	55
Saturation Flow Module:												
Sat/Lane:	1900	1900	1900	1900	1900	1900	1900	1900	1900	1900	1900	1900
Adjustment:	0.92	0.95	0.95	0.92	0.95	0.95	0.92	0.98	0.95	0.92	1.00	0.92
Lanes:	1.00	0.28	0.72	1.00	0.58	0.42	1.00	1.82	0.18	1.00	2.00	1.00
Final Sat.:	1750	501	1299	1750	1038	762	1750	3376	323	1750	3800	1750
Capacity Analysis Module:												
Vol/Sat:	0.02	0.05	0.05	0.03	0.03	0.03	0.01	0.22	0.22	0.02	0.13	0.03
Crit Moves:	****			****			****			****		
Green Time:	9.7	14.3	14.3	9.1	13.8	13.8	23.1	57.6	57.6	7.0	41.4	41.4
Volume/Cap:	0.21	0.38	0.38	0.38	0.21	0.21	0.03	0.38	0.38	0.27	0.30	0.08
Uniform Del:	41.6	38.8	38.8	42.8	38.3	38.3	29.8	11.5	11.5	44.1	19.6	17.7
IncrementDel:	0.6	0.9	0.9	1.5	0.4	0.4	0.0	0.1	0.1	1.2	0.1	0.0
InitQueueDel:	0.0	0.0	0.0	0.0	0.0	0.0	0.0	0.0	0.0	0.0	0.0	0.0
Delay Adj:	1.00	1.00	1.00	1.00	1.00	1.00	1.00	1.00	1.00	1.00	1.00	1.00
Delay/Veh:	42.3	39.7	39.7	44.3	38.7	38.7	29.8	11.6	11.6	45.3	19.7	17.7
User DelAdj:	1.00	1.00	1.00	1.00	1.00	1.00	1.00	1.00	1.00	1.00	1.00	1.00
AdjDel/Veh:	42.3	39.7	39.7	44.3	38.7	38.7	29.8	11.6	11.6	45.3	19.7	17.7
LOS by Move:	D	D	D	D	D+	D+	C	B+	B+	D	B-	B
HCM2kAvgQ:	1	3	3	2	2	2	0	7	7	1	5	1

Note: Queue reported is the number of cars per lane.

San Antonio Village Phase III MTA
 SJ21-2068
 Background PM

Level Of Service Computation Report
 2000 HCM Operations (Future Volume Alternative)
 Background PP PM

Intersection #13: California Street and Ortega Avenue

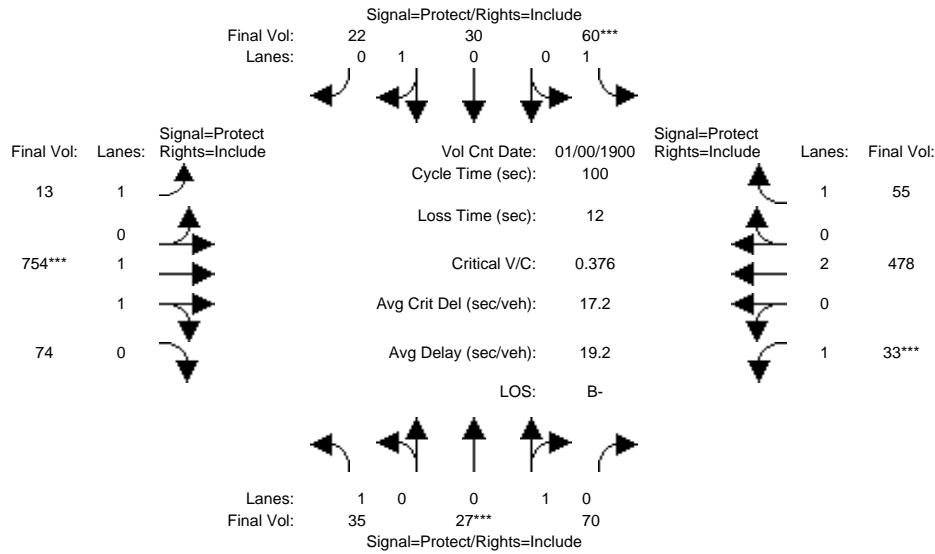

Approach:	North Bound			South Bound			East Bound			West Bound		
Movement:	L	T	R	L	T	R	L	T	R	L	T	R
Min. Green:	7	10	10	7	10	10	7	10	10	7	10	10
Y+R:	4.0	4.0	4.0	4.0	4.0	4.0	4.0	4.0	4.0	4.0	4.0	4.0
Volume Module: >> Count Date: 0 Jan 1900 << 12:00:00 AM												
Base Vol:	35	27	70	60	30	22	13	730	70	33	471	55
Growth Adj:	1.00	1.00	1.00	1.00	1.00	1.00	1.00	1.00	1.00	1.00	1.00	1.00
Initial Bse:	35	27	70	60	30	22	13	730	70	33	471	55
Added Vol:	0	0	0	0	0	0	0	24	4	0	7	0
PasserByVol:	0	0	0	0	0	0	0	0	0	0	0	0
Initial Fut:	35	27	70	60	30	22	13	754	74	33	478	55
User Adj:	1.00	1.00	1.00	1.00	1.00	1.00	1.00	1.00	1.00	1.00	1.00	1.00
PHF Adj:	1.00	1.00	1.00	1.00	1.00	1.00	1.00	1.00	1.00	1.00	1.00	1.00
PHF Volume:	35	27	70	60	30	22	13	754	74	33	478	55
Reduct Vol:	0	0	0	0	0	0	0	0	0	0	0	0
Reduced Vol:	35	27	70	60	30	22	13	754	74	33	478	55
PCE Adj:	1.00	1.00	1.00	1.00	1.00	1.00	1.00	1.00	1.00	1.00	1.00	1.00
MLF Adj:	1.00	1.00	1.00	1.00	1.00	1.00	1.00	1.00	1.00	1.00	1.00	1.00
Final Volume:	35	27	70	60	30	22	13	754	74	33	478	55
Saturation Flow Module:												
Sat/Lane:	1900	1900	1900	1900	1900	1900	1900	1900	1900	1900	1900	1900
Adjustment:	0.92	0.95	0.95	0.92	0.95	0.95	0.92	0.98	0.95	0.92	1.00	0.92
Lanes:	1.00	0.28	0.72	1.00	0.58	0.42	1.00	1.82	0.18	1.00	2.00	1.00
Final Sat.:	1750	501	1299	1750	1038	762	1750	3369	331	1750	3800	1750
Capacity Analysis Module:												
Vol/Sat:	0.02	0.05	0.05	0.03	0.03	0.03	0.01	0.22	0.22	0.02	0.13	0.03
Crit Moves:	****			****			****			****		
Green Time:	9.4	14.0	14.0	8.9	13.5	13.5	23.3	58.1	58.1	7.0	41.8	41.8
Volume/Cap:	0.21	0.39	0.39	0.39	0.21	0.21	0.03	0.39	0.39	0.27	0.30	0.08
Delay/Veh:	42.5	40.1	40.1	44.6	39.0	39.0	29.7	11.4	11.4	45.3	19.5	17.5
User DelAdj:	1.00	1.00	1.00	1.00	1.00	1.00	1.00	1.00	1.00	1.00	1.00	1.00
AdjDel/Veh:	42.5	40.1	40.1	44.6	39.0	39.0	29.7	11.4	11.4	45.3	19.5	17.5
LOS by Move:	D	D	D	D	D+	D+	C	B+	B+	D	B-	B
HCM2kAvgQ:	1	3	3	2	2	2	0	7	7	1	5	1

Note: Queue reported is the number of cars per lane.

San Antonio Village Phase III MTA
 SJ21-2068
 Background PM

Level Of Service Computation Report
 2000 HCM Operations (Future Volume Alternative)
 Background PM

Intersection #14: California Street and Rengstorff Avenue

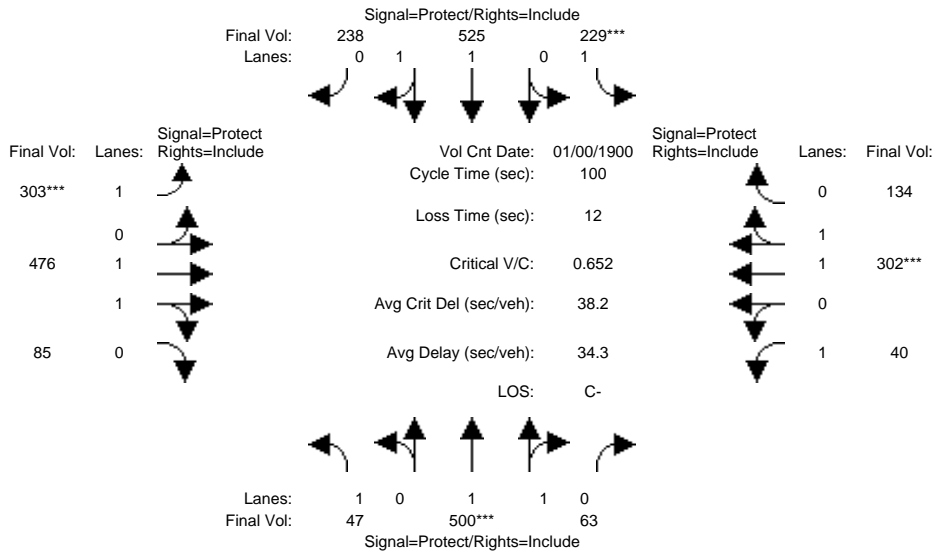

Approach:	North Bound			South Bound			East Bound			West Bound		
Movement:	L	T	R	L	T	R	L	T	R	L	T	R
Min. Green:	7	10	10	7	10	10	7	10	10	7	10	10
Y+R:	4.0	4.0	4.0	4.0	4.0	4.0	4.0	4.0	4.0	4.0	4.0	4.0
Volume Module: >> Count Date: 0 Jan 1900 << 12:00:00 AM												
Base Vol:	45	485	63	229	500	234	302	476	85	40	302	134
Growth Adj:	1.00	1.00	1.00	1.00	1.00	1.00	1.00	1.00	1.00	1.00	1.00	1.00
Initial Bse:	45	485	63	229	500	234	302	476	85	40	302	134
Added Vol:	2	15	0	0	25	4	1	0	0	0	0	0
PasserByVol:	0	0	0	0	0	0	0	0	0	0	0	0
Initial Fut:	47	500	63	229	525	238	303	476	85	40	302	134
User Adj:	1.00	1.00	1.00	1.00	1.00	1.00	1.00	1.00	1.00	1.00	1.00	1.00
PHF Adj:	1.00	1.00	1.00	1.00	1.00	1.00	1.00	1.00	1.00	1.00	1.00	1.00
PHF Volume:	47	500	63	229	525	238	303	476	85	40	302	134
Reduct Vol:	0	0	0	0	0	0	0	0	0	0	0	0
Reduced Vol:	47	500	63	229	525	238	303	476	85	40	302	134
PCE Adj:	1.00	1.00	1.00	1.00	1.00	1.00	1.00	1.00	1.00	1.00	1.00	1.00
MLF Adj:	1.00	1.00	1.00	1.00	1.00	1.00	1.00	1.00	1.00	1.00	1.00	1.00
FinalVolume:	47	500	63	229	525	238	303	476	85	40	302	134
Saturation Flow Module:												
Sat/Lane:	1900	1900	1900	1900	1900	1900	1900	1900	1900	1900	1900	1900
Adjustment:	0.92	0.98	0.95	0.92	0.99	0.95	0.92	0.98	0.95	0.92	0.99	0.95
Lanes:	1.00	1.77	0.23	1.00	1.36	0.64	1.00	1.69	0.31	1.00	1.37	0.63
Final Sat.:	1750	3286	414	1750	2545	1154	1750	3139	561	1750	2562	1137
Capacity Analysis Module:												
Vol/Sat:	0.03	0.15	0.15	0.13	0.21	0.21	0.17	0.15	0.15	0.02	0.12	0.12
Crit Moves:	****			****			****			****		
Green Time:	11.0	23.3	23.3	20.1	32.4	32.4	26.5	30.5	30.5	14.1	18.1	18.1
Volume/Cap:	0.24	0.65	0.65	0.65	0.64	0.64	0.65	0.50	0.50	0.16	0.65	0.65
Uniform Del:	40.7	34.7	34.7	36.8	28.8	28.8	32.6	28.4	28.4	37.8	38.0	38.0
IncrcmntDel:	0.7	1.8	1.8	4.3	1.1	1.1	3.3	0.3	0.3	0.3	2.3	2.3
InitQueuDel:	0.0	0.0	0.0	0.0	0.0	0.0	0.0	0.0	0.0	0.0	0.0	0.0
Delay Adj:	1.00	1.00	1.00	1.00	1.00	1.00	1.00	1.00	1.00	1.00	1.00	1.00
Delay/Veh:	41.4	36.5	36.5	41.1	29.9	29.9	35.9	28.8	28.8	38.1	40.4	40.4
User DelAdj:	1.00	1.00	1.00	1.00	1.00	1.00	1.00	1.00	1.00	1.00	1.00	1.00
AdjDel/Veh:	41.4	36.5	36.5	41.1	29.9	29.9	35.9	28.8	28.8	38.1	40.4	40.4
LOS by Move:	D	D+	D+	D	C	C	D+	C	C	D+	D	D
HCM2kAvgQ:	1	8	8	7	10	10	9	7	7	1	7	7

Note: Queue reported is the number of cars per lane.

San Antonio Village Phase III MTA
 SJ21-2068
 Background PM

Level Of Service Computation Report
 2000 HCM Operations (Future Volume Alternative)
 Background PP PM

Intersection #14: California Street and Rengstorff Avenue

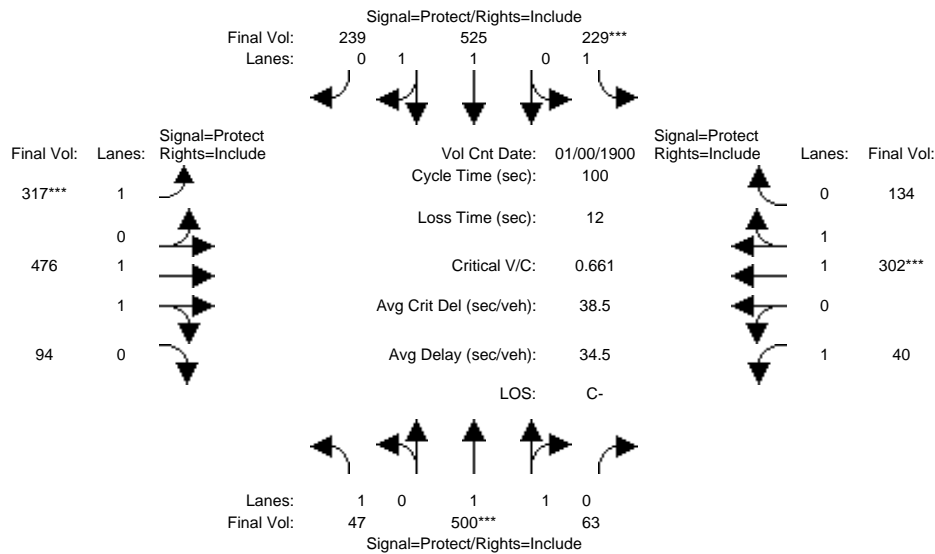

Approach:	North Bound			South Bound			East Bound			West Bound		
Movement:	L	T	R	L	T	R	L	T	R	L	T	R
Min. Green:	7	10	10	7	10	10	7	10	10	7	10	10
Y+R:	4.0	4.0	4.0	4.0	4.0	4.0	4.0	4.0	4.0	4.0	4.0	4.0
Volume Module: >> Count Date: 0 Jan 1900 << 12:00:00 AM												
Base Vol:	45	485	63	229	500	234	302	476	85	40	302	134
Growth Adj:	1.00	1.00	1.00	1.00	1.00	1.00	1.00	1.00	1.00	1.00	1.00	1.00
Initial Bse:	45	485	63	229	500	234	302	476	85	40	302	134
Added Vol:	2	15	0	0	25	5	15	0	9	0	0	0
PasserByVol:	0	0	0	0	0	0	0	0	0	0	0	0
Initial Fut:	47	500	63	229	525	239	317	476	94	40	302	134
User Adj:	1.00	1.00	1.00	1.00	1.00	1.00	1.00	1.00	1.00	1.00	1.00	1.00
PHF Adj:	1.00	1.00	1.00	1.00	1.00	1.00	1.00	1.00	1.00	1.00	1.00	1.00
PHF Volume:	47	500	63	229	525	239	317	476	94	40	302	134
Reduct Vol:	0	0	0	0	0	0	0	0	0	0	0	0
Reduced Vol:	47	500	63	229	525	239	317	476	94	40	302	134
PCE Adj:	1.00	1.00	1.00	1.00	1.00	1.00	1.00	1.00	1.00	1.00	1.00	1.00
MLF Adj:	1.00	1.00	1.00	1.00	1.00	1.00	1.00	1.00	1.00	1.00	1.00	1.00
Final Volume:	47	500	63	229	525	239	317	476	94	40	302	134
Saturation Flow Module:												
Sat/Lane:	1900	1900	1900	1900	1900	1900	1900	1900	1900	1900	1900	1900
Adjustment:	0.92	0.98	0.95	0.92	0.99	0.95	0.92	0.98	0.95	0.92	0.99	0.95
Lanes:	1.00	1.77	0.23	1.00	1.36	0.64	1.00	1.66	0.34	1.00	1.37	0.63
Final Sat.:	1750	3286	414	1750	2542	1157	1750	3089	610	1750	2562	1137
Capacity Analysis Module:												
Vol/Sat:	0.03	0.15	0.15	0.13	0.21	0.21	0.18	0.15	0.15	0.02	0.12	0.12
Crit Moves:	****			****			****			****		
Green Time:	10.8	23.0	23.0	19.8	32.0	32.0	27.4	31.1	31.1	14.1	17.8	17.8
Volume/Cap:	0.25	0.66	0.66	0.66	0.65	0.65	0.66	0.50	0.50	0.16	0.66	0.66
Delay/Veh:	41.5	36.9	36.9	41.7	30.4	30.4	35.6	28.4	28.4	38.0	40.8	40.8
User DelAdj:	1.00	1.00	1.00	1.00	1.00	1.00	1.00	1.00	1.00	1.00	1.00	1.00
AdjDel/Veh:	41.5	36.9	36.9	41.7	30.4	30.4	35.6	28.4	28.4	38.0	40.8	40.8
LOS by Move:	D	D+	D+	D	C	C	D+	C	C	D+	D	D
HCM2kAvgQ:	1	8	8	7	10	10	9	7	7	1	8	8

Note: Queue reported is the number of cars per lane.

San Antonio Village Phase III MTA
 SJ21-2068
 Background PM

Level Of Service Computation Report
 2000 HCM Operations (Future Volume Alternative)
 Background PM

Intersection #15: Central Expressway and Rengstorff Avenue

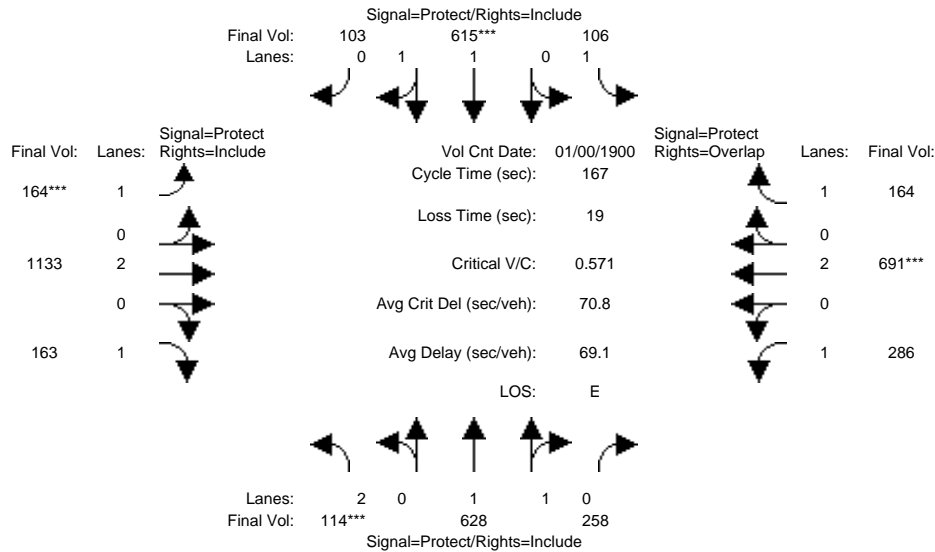

Approach:	North Bound			South Bound			East Bound			West Bound		
	L	T	R	L	T	R	L	T	R	L	T	R
Min. Green:	28	49	49	14	35	35	12	49	49	34	71	71
Y+R:	5.0	5.1	5.1	5.4	5.1	5.1	4.8	5.8	5.8	5.0	5.8	5.8

Volume Module: >> Count Date: 0 Jan 1900 << 12:00:00 AM

Base Vol:	113	621	251	103	603	90	158	1125	163	269	666	158
Growth Adj:	1.00	1.00	1.00	1.00	1.00	1.00	1.00	1.00	1.00	1.00	1.00	1.00
Initial Bse:	113	621	251	103	603	90	158	1125	163	269	666	158
Added Vol:	1	7	7	3	12	13	6	8	0	17	25	6
PasserByVol:	0	0	0	0	0	0	0	0	0	0	0	0
Initial Fut:	114	628	258	106	615	103	164	1133	163	286	691	164
User Adj:	1.00	1.00	1.00	1.00	1.00	1.00	1.00	1.00	1.00	1.00	1.00	1.00
PHF Adj:	1.00	1.00	1.00	1.00	1.00	1.00	1.00	1.00	1.00	1.00	1.00	1.00
PHF Volume:	114	628	258	106	615	103	164	1133	163	286	691	164
Reduct Vol:	0	0	0	0	0	0	0	0	0	0	0	0
Reduced Vol:	114	628	258	106	615	103	164	1133	163	286	691	164
PCE Adj:	1.00	1.00	1.00	1.00	1.00	1.00	1.00	1.00	1.00	1.00	1.00	1.00
MLF Adj:	1.00	1.00	1.00	1.00	1.00	1.00	1.00	1.00	1.00	1.00	1.00	1.00
FinalVolume:	114	628	258	106	615	103	164	1133	163	286	691	164

Saturation Flow Module:

Sat/Lane:	1900	1900	1900	1900	1900	1900	1900	1900	1900	1900	1900	1900
Adjustment:	0.83	0.98	0.95	0.92	0.98	0.95	0.92	1.00	0.92	0.92	1.00	0.92
Lanes:	2.00	1.40	0.60	1.00	1.71	0.29	1.00	2.00	1.00	1.00	2.00	1.00
Final Sat.:	3150	2622	1077	1750	3169	531	1750	3800	1750	1750	3800	1750

Capacity Analysis Module:

Vol/Sat:	0.04	0.24	0.24	0.06	0.19	0.19	0.09	0.30	0.09	0.16	0.18	0.09
Crit Moves:	****			****			****			****		
Green Time:	28.0	49.0	49.0	14.0	35.0	35.0	14.0	50.5	50.5	34.5	71.0	85.0
Volume/Cap:	0.22	0.82	0.82	0.72	0.93	0.93	1.12	0.99	0.31	0.79	0.43	0.18
Uniform Del:	60.0	54.8	54.8	74.6	64.7	64.7	76.5	57.9	44.8	62.8	33.7	22.2
IncrcmntDel:	0.2	4.9	4.9	16.2	17.0	17.0	109.4	23.1	0.3	11.3	0.2	0.1
InitQueuDel:	0.0	0.0	0.0	0.0	0.0	0.0	0.0	0.0	0.0	0.0	0.0	0.0
Delay Adj:	1.00	1.00	1.00	1.00	1.00	1.00	1.00	1.00	1.00	1.00	1.00	1.00
Delay/Veh:	60.2	59.7	59.7	90.8	81.7	81.7	185.9	80.9	45.1	74.1	33.9	22.3
User DelAdj:	1.00	1.00	1.00	1.00	1.00	1.00	1.00	1.00	1.00	1.00	1.00	1.00
AdjDel/Veh:	60.2	59.7	59.7	90.8	81.7	81.7	185.9	80.9	45.1	74.1	33.9	22.3
LOS by Move:	E	E+	E+	F	F	F	F	F	D	E	C-	C+
HCM2kAvgQ:	3	22	22	7	22	22	12	33	7	17	12	5

Note: Queue reported is the number of cars per lane.

San Antonio Village Phase III MTA
 SJ21-2068
 Background PM

Level Of Service Computation Report
 2000 HCM Operations (Future Volume Alternative)
 Background PP PM

Intersection #15: Central Expressway and Rengstorff Avenue

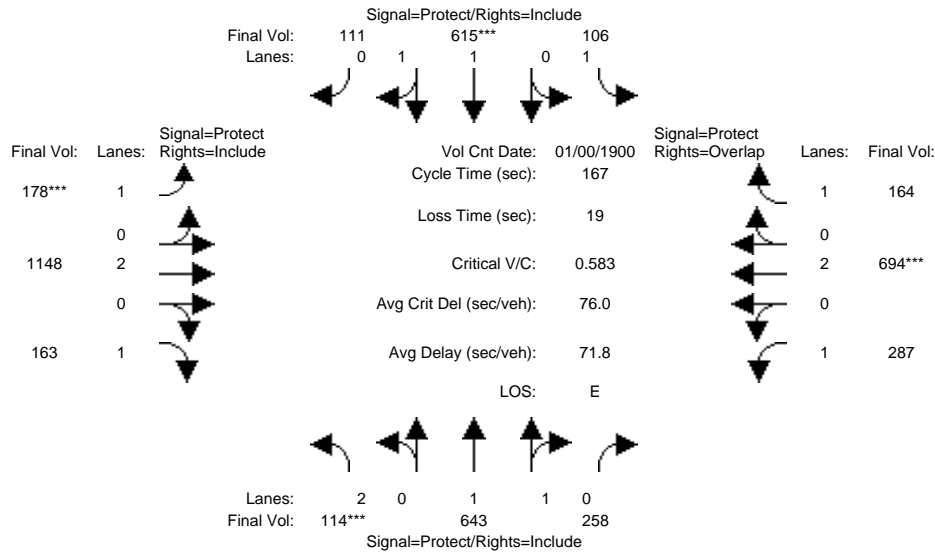

Approach:	North Bound			South Bound			East Bound			West Bound		
	L	T	R	L	T	R	L	T	R	L	T	R
Min. Green:	28	49	49	14	35	35	12	49	49	34	71	71
Y+R:	5.0	5.1	5.1	5.4	5.1	5.1	4.8	5.8	5.8	5.0	5.8	5.8

Volume Module:	>> Count Date: 0 Jan 1900 << 12:00:00 AM											
Base Vol:	113	621	251	103	603	90	158	1125	163	269	666	158
Growth Adj:	1.00	1.00	1.00	1.00	1.00	1.00	1.00	1.00	1.00	1.00	1.00	1.00
Initial Bse:	113	621	251	103	603	90	158	1125	163	269	666	158
Added Vol:	1	22	7	3	12	21	20	23	0	18	28	6
PasserByVol:	0	0	0	0	0	0	0	0	0	0	0	0
Initial Fut:	114	643	258	106	615	111	178	1148	163	287	694	164
User Adj:	1.00	1.00	1.00	1.00	1.00	1.00	1.00	1.00	1.00	1.00	1.00	1.00
PHF Adj:	1.00	1.00	1.00	1.00	1.00	1.00	1.00	1.00	1.00	1.00	1.00	1.00
PHF Volume:	114	643	258	106	615	111	178	1148	163	287	694	164
Reduct Vol:	0	0	0	0	0	0	0	0	0	0	0	0
Reduced Vol:	114	643	258	106	615	111	178	1148	163	287	694	164
PCE Adj:	1.00	1.00	1.00	1.00	1.00	1.00	1.00	1.00	1.00	1.00	1.00	1.00
MLF Adj:	1.00	1.00	1.00	1.00	1.00	1.00	1.00	1.00	1.00	1.00	1.00	1.00
Final Volume:	114	643	258	106	615	111	178	1148	163	287	694	164

Saturation Flow Module:												
Sat/Lane:	1900	1900	1900	1900	1900	1900	1900	1900	1900	1900	1900	1900
Adjustment:	0.83	0.98	0.95	0.92	0.98	0.95	0.92	1.00	0.92	0.92	1.00	0.92
Lanes:	2.00	1.41	0.59	1.00	1.69	0.31	1.00	2.00	1.00	1.00	2.00	1.00
Final Sat.:	3150	2640	1059	1750	3134	566	1750	3800	1750	1750	3800	1750

Capacity Analysis Module:												
Vol/Sat:	0.04	0.24	0.24	0.06	0.20	0.20	0.10	0.30	0.09	0.16	0.18	0.09
Crit Moves:	****			****			****			****		
Green Time:	28.0	49.0	49.0	14.0	35.0	35.0	14.0	50.8	50.8	34.2	71.0	85.0
Volume/Cap:	0.22	0.83	0.83	0.72	0.94	0.94	1.21	0.99	0.31	0.80	0.43	0.18
Delay/Veh:	60.2	60.6	60.6	90.8	83.5	83.5	219.4	82.8	44.9	75.2	33.9	22.3
User DelAdj:	1.00	1.00	1.00	1.00	1.00	1.00	1.00	1.00	1.00	1.00	1.00	1.00
AdjDel/Veh:	60.2	60.6	60.6	90.8	83.5	83.5	219.4	82.8	44.9	75.2	33.9	22.3
LOS by Move:	E	E	E	F	F	F	F	F	D	E-	C-	C+
HCM2kAvgQ:	3	23	23	7	22	22	15	34	7	17	12	5

Note: Queue reported is the number of cars per lane.

San Antonio Village Phase III MTA
SJ21-2068
Background PM

Level Of Service Computation Report
2000 HCM Operations (Future Volume Alternative)
Background PM

Intersection #16: Middlefield Road and San Antonio Road

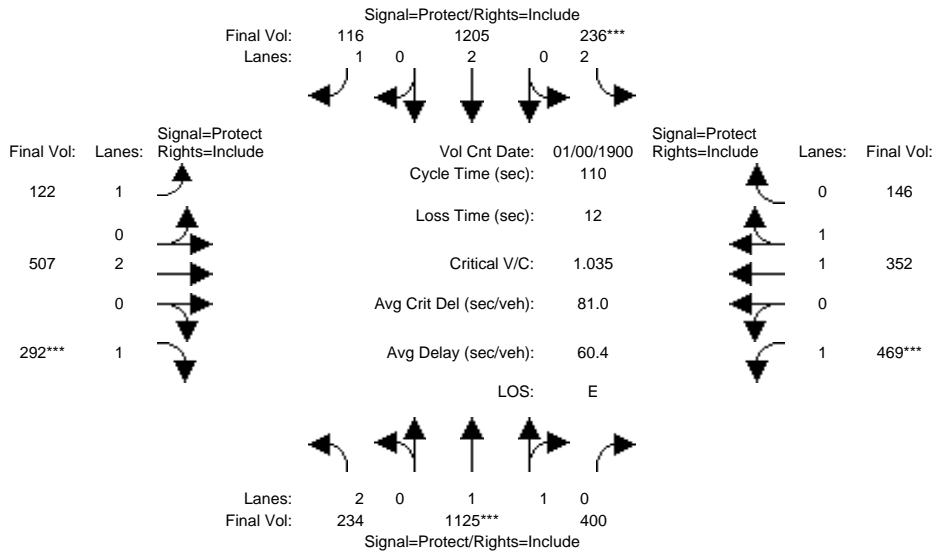

Approach:	North Bound			South Bound			East Bound			West Bound		
Movement:	L	T	R	L	T	R	L	T	R	L	T	R
Min. Green:	7	10	10	7	10	10	7	10	10	7	10	10
Y+R:	4.0	4.0	4.0	4.0	4.0	4.0	4.0	4.0	4.0	4.0	4.0	4.0
Volume Module: >> Count Date: 0 Jan 1900 << 12:00:00 AM												
Base Vol:	232	1107	390	214	1162	110	113	480	281	452	335	133
Growth Adj:	1.00	1.00	1.00	1.00	1.00	1.00	1.00	1.00	1.00	1.00	1.00	1.00
Initial Bse:	232	1107	390	214	1162	110	113	480	281	452	335	133
Added Vol:	2	18	10	22	43	6	9	27	11	17	17	13
PasserByVol:	0	0	0	0	0	0	0	0	0	0	0	0
Initial Fut:	234	1125	400	236	1205	116	122	507	292	469	352	146
User Adj:	1.00	1.00	1.00	1.00	1.00	1.00	1.00	1.00	1.00	1.00	1.00	1.00
PHF Adj:	1.00	1.00	1.00	1.00	1.00	1.00	1.00	1.00	1.00	1.00	1.00	1.00
PHF Volume:	234	1125	400	236	1205	116	122	507	292	469	352	146
Reduct Vol:	0	0	0	0	0	0	0	0	0	0	0	0
Reduced Vol:	234	1125	400	236	1205	116	122	507	292	469	352	146
PCE Adj:	1.00	1.00	1.00	1.00	1.00	1.00	1.00	1.00	1.00	1.00	1.00	1.00
MLF Adj:	1.00	1.00	1.00	1.00	1.00	1.00	1.00	1.00	1.00	1.00	1.00	1.00
Final Volume:	234	1125	400	236	1205	116	122	507	292	469	352	146
Saturation Flow Module:												
Sat/Lane:	1900	1900	1900	1900	1900	1900	1900	1900	1900	1900	1900	1900
Adjustment:	0.83	0.98	0.95	0.83	1.00	0.92	0.92	1.00	0.92	0.92	0.98	0.95
Lanes:	2.00	1.46	0.54	2.00	2.00	1.00	1.00	2.00	1.00	1.00	1.40	0.60
Final Sat.:	3150	2729	970	3150	3800	1750	1750	3800	1750	1750	2614	1084
Capacity Analysis Module:												
Vol/Sat:	0.07	0.41	0.41	0.07	0.32	0.07	0.07	0.13	0.17	0.27	0.13	0.13
Crit Moves:	****	****	****	****	****	****	****	****	****	****	****	****
Green Time:	9.8	43.8	43.8	8.0	42.0	42.0	15.8	17.7	17.7	28.5	30.5	30.5
Volume/Cap:	0.83	1.03	1.03	1.03	0.83	0.17	0.49	0.83	1.03	1.03	0.49	0.49
Uniform Del:	49.3	33.1	33.1	51.0	30.8	22.5	43.4	44.7	46.1	40.8	33.2	33.2
IncrcmntDel:	18.5	33.0	33.0	69.0	4.2	0.1	1.5	9.1	62.9	51.6	0.4	0.4
InitQueuDel:	0.0	0.0	0.0	0.0	0.0	0.0	0.0	0.0	0.0	0.0	0.0	0.0
Delay Adj:	1.00	1.00	1.00	1.00	1.00	1.00	1.00	1.00	1.00	1.00	1.00	1.00
Delay/Veh:	67.8	66.1	66.1	120.0	35.1	22.7	44.9	53.8	109.1	92.3	33.6	33.6
User DelAdj:	1.00	1.00	1.00	1.00	1.00	1.00	1.00	1.00	1.00	1.00	1.00	1.00
AdjDel/Veh:	67.8	66.1	66.1	120.0	35.1	22.7	44.9	53.8	109.1	92.3	33.6	33.6
LOS by Move:	E	E	E	F	D+	C+	D	D-	F	F	C-	C-
HCM2kAvgQ:	5	33	33	7	19	3	5	11	17	25	7	7

Note: Queue reported is the number of cars per lane.

San Antonio Village Phase III MTA
 SJ21-2068
 Background PM

Level Of Service Computation Report
 2000 HCM Operations (Future Volume Alternative)
 Background PP PM

Intersection #16: Middlefield Road and San Antonio Road

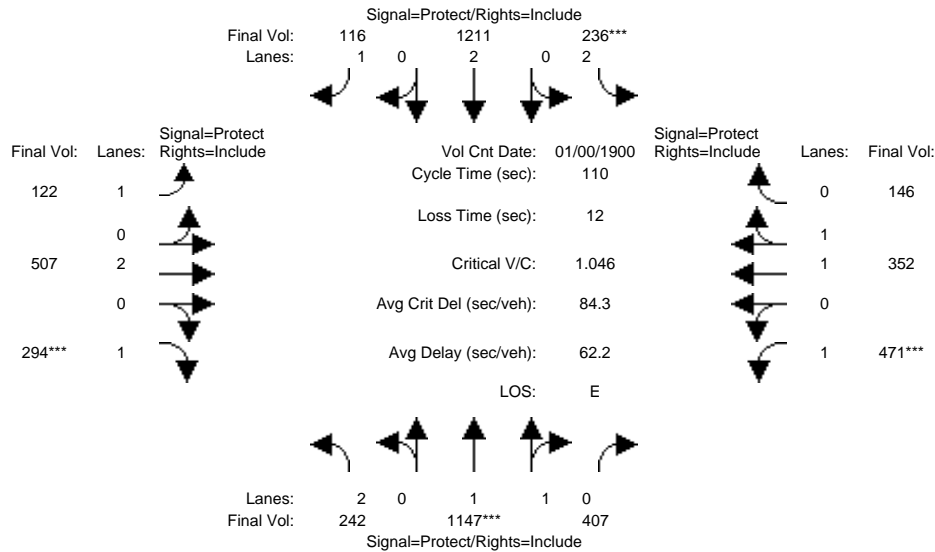

Approach:	North Bound			South Bound			East Bound			West Bound		
Movement:	L	T	R	L	T	R	L	T	R	L	T	R
Min. Green:	7	10	10	7	10	10	7	10	10	7	10	10
Y+R:	4.0	4.0	4.0	4.0	4.0	4.0	4.0	4.0	4.0	4.0	4.0	4.0
Volume Module: >> Count Date: 0 Jan 1900 << 12:00:00 AM												
Base Vol:	232	1107	390	214	1162	110	113	480	281	452	335	133
Growth Adj:	1.00	1.00	1.00	1.00	1.00	1.00	1.00	1.00	1.00	1.00	1.00	1.00
Initial Bse:	232	1107	390	214	1162	110	113	480	281	452	335	133
Added Vol:	10	40	17	22	49	6	9	27	13	19	17	13
PasserByVol:	0	0	0	0	0	0	0	0	0	0	0	0
Initial Fut:	242	1147	407	236	1211	116	122	507	294	471	352	146
User Adj:	1.00	1.00	1.00	1.00	1.00	1.00	1.00	1.00	1.00	1.00	1.00	1.00
PHF Adj:	1.00	1.00	1.00	1.00	1.00	1.00	1.00	1.00	1.00	1.00	1.00	1.00
PHF Volume:	242	1147	407	236	1211	116	122	507	294	471	352	146
Reduct Vol:	0	0	0	0	0	0	0	0	0	0	0	0
Reduced Vol:	242	1147	407	236	1211	116	122	507	294	471	352	146
PCE Adj:	1.00	1.00	1.00	1.00	1.00	1.00	1.00	1.00	1.00	1.00	1.00	1.00
MLF Adj:	1.00	1.00	1.00	1.00	1.00	1.00	1.00	1.00	1.00	1.00	1.00	1.00
Final Volume:	242	1147	407	236	1211	116	122	507	294	471	352	146
Saturation Flow Module:												
Sat/Lane:	1900	1900	1900	1900	1900	1900	1900	1900	1900	1900	1900	1900
Adjustment:	0.83	0.98	0.95	0.83	1.00	0.92	0.92	1.00	0.92	0.92	0.98	0.95
Lanes:	2.00	1.46	0.54	2.00	2.00	1.00	1.00	2.00	1.00	1.00	1.40	0.60
Final Sat.:	3150	2730	969	3150	3800	1750	1750	3800	1750	1750	2614	1084
Capacity Analysis Module:												
Vol/Sat:	0.08	0.42	0.42	0.07	0.32	0.07	0.07	0.13	0.17	0.27	0.13	0.13
Crit Moves:	****			****			****			****		
Green Time:	10.1	44.2	44.2	7.9	41.9	41.9	15.7	17.7	17.7	28.3	30.3	30.3
Volume/Cap:	0.84	1.05	1.05	1.05	0.84	0.17	0.49	0.83	1.05	1.05	0.49	0.49
Delay/Veh:	67.8	69.4	69.4	123.7	35.3	22.7	45.0	54.1	112.5	95.9	33.8	33.8
User DelAdj:	1.00	1.00	1.00	1.00	1.00	1.00	1.00	1.00	1.00	1.00	1.00	1.00
AdjDel/Veh:	67.8	69.4	69.4	123.7	35.3	22.7	45.0	54.1	112.5	95.9	33.8	33.8
LOS by Move:	E	E	E	F	D+	C+	D	D-	F	F	C-	C-
HCM2kAvgQ:	5	34	34	7	20	3	5	11	17	25	7	7

Note: Queue reported is the number of cars per lane.

San Antonio Village Phase III MTA
 SJ21-2068
 Background PM

Level Of Service Computation Report
 2000 HCM Operations (Future Volume Alternative)
 Background PM

Intersection #17: Charleston Road and San Antonio Road

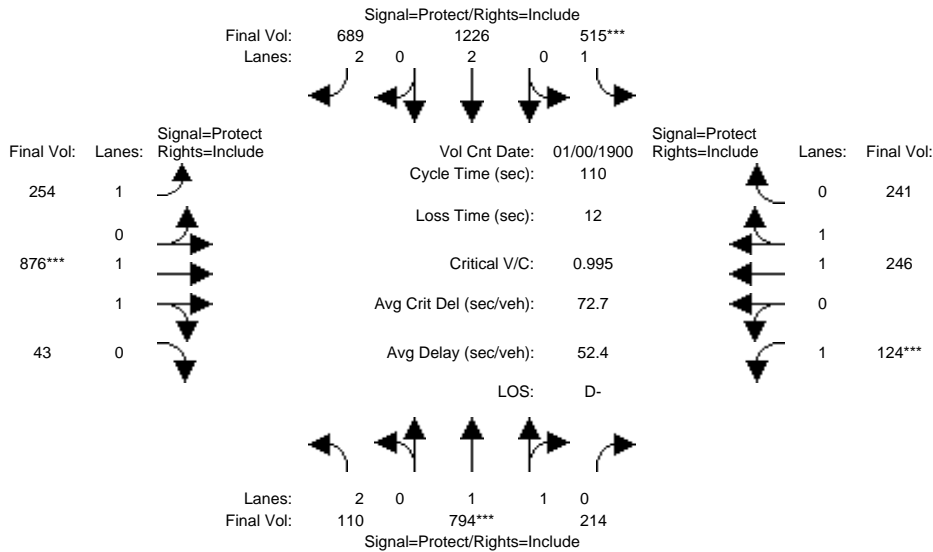

Approach:	North Bound			South Bound			East Bound			West Bound		
Movement:	L	T	R	L	T	R	L	T	R	L	T	R
Min. Green:	7	10	10	7	10	10	7	10	10	7	10	10
Y+R:	4.0	4.0	4.0	4.0	4.0	4.0	4.0	4.0	4.0	4.0	4.0	4.0
Volume Module: >> Count Date: 0 Jan 1900 << 12:00:00 AM												
Base Vol:	110	769	199	495	1165	689	254	876	43	113	246	226
Growth Adj:	1.00	1.00	1.00	1.00	1.00	1.00	1.00	1.00	1.00	1.00	1.00	1.00
Initial Bse:	110	769	199	495	1165	689	254	876	43	113	246	226
Added Vol:	0	25	15	20	61	0	0	0	0	11	0	15
PasserByVol:	0	0	0	0	0	0	0	0	0	0	0	0
Initial Fut:	110	794	214	515	1226	689	254	876	43	124	246	241
User Adj:	1.00	1.00	1.00	1.00	1.00	1.00	1.00	1.00	1.00	1.00	1.00	1.00
PHF Adj:	1.00	1.00	1.00	1.00	1.00	1.00	1.00	1.00	1.00	1.00	1.00	1.00
PHF Volume:	110	794	214	515	1226	689	254	876	43	124	246	241
Reduct Vol:	0	0	0	0	0	0	0	0	0	0	0	0
Reduced Vol:	110	794	214	515	1226	689	254	876	43	124	246	241
PCE Adj:	1.00	1.00	1.00	1.00	1.00	1.00	1.00	1.00	1.00	1.00	1.00	1.00
MLF Adj:	1.00	1.00	1.00	1.00	1.00	1.00	1.00	1.00	1.00	1.00	1.00	1.00
FinalVolume:	110	794	214	515	1226	689	254	876	43	124	246	241
Saturation Flow Module:												
Sat/Lane:	1900	1900	1900	1900	1900	1900	1900	1900	1900	1900	1900	1900
Adjustment:	0.83	0.98	0.95	0.92	1.00	0.83	0.92	0.97	0.95	0.92	1.00	0.95
Lanes:	2.00	1.56	0.44	1.00	2.00	2.00	1.00	1.90	0.10	1.00	1.00	1.00
Final Sat.:	3150	2914	785	1750	3800	3150	1750	3527	173	1750	1899	1800
Capacity Analysis Module:												
Vol/Sat:	0.03	0.27	0.27	0.29	0.32	0.22	0.15	0.25	0.25	0.07	0.13	0.13
Crit Moves:	****			****			****			****		
Green Time:	10.3	30.1	30.1	32.6	52.4	52.4	18.4	27.5	27.5	7.8	16.9	16.9
Volume/Cap:	0.37	0.99	0.99	0.99	0.68	0.46	0.87	0.99	0.99	0.99	0.84	0.87
Uniform Del:	46.8	39.8	39.8	38.6	22.3	19.3	44.6	41.2	41.2	51.1	45.2	45.4
IncrcmntDel:	0.8	26.9	26.9	38.1	1.0	0.2	23.2	28.2	28.2	78.8	10.7	13.7
InitQueuDel:	0.0	0.0	0.0	0.0	0.0	0.0	0.0	0.0	0.0	0.0	0.0	0.0
Delay Adj:	1.00	1.00	1.00	1.00	1.00	1.00	1.00	1.00	1.00	1.00	1.00	1.00
Delay/Veh:	47.6	66.7	66.7	76.7	23.3	19.6	67.9	69.4	69.4	129.9	55.9	59.1
User DelAdj:	1.00	1.00	1.00	1.00	1.00	1.00	1.00	1.00	1.00	1.00	1.00	1.00
AdjDel/Veh:	47.6	66.7	66.7	76.7	23.3	19.6	67.9	69.4	69.4	129.9	55.9	59.1
LOS by Move:	D	E	E	E-	C	B-	E	E	E	F	E+	E+
HCM2kAvgQ:	2	21	21	25	16	9	12	22	22	8	11	11

Note: Queue reported is the number of cars per lane.

San Antonio Village Phase III MTA
 SJ21-2068
 Background PM

Level Of Service Computation Report
 2000 HCM Operations (Future Volume Alternative)
 Background PP PM

Intersection #17: Charleston Road and San Antonio Road

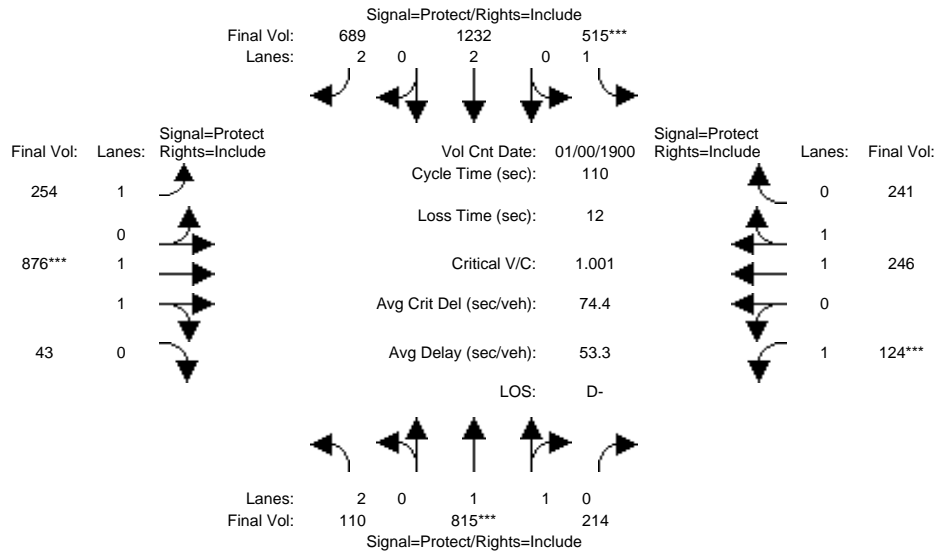

Approach:	North Bound			South Bound			East Bound			West Bound		
	L	T	R	L	T	R	L	T	R	L	T	R
Min. Green:	7	10	10	7	10	10	7	10	10	7	10	10
Y+R:	4.0	4.0	4.0	4.0	4.0	4.0	4.0	4.0	4.0	4.0	4.0	4.0

Volume Module:	>>	Count	Date:	0	Jan	1900	<<	12:00:00	AM			
Base Vol:	110	769	199	495	1165	689	254	876	43	113	246	226
Growth Adj:	1.00	1.00	1.00	1.00	1.00	1.00	1.00	1.00	1.00	1.00	1.00	1.00
Initial Bse:	110	769	199	495	1165	689	254	876	43	113	246	226
Added Vol:	0	46	15	20	67	0	0	0	0	11	0	15
PasserByVol:	0	0	0	0	0	0	0	0	0	0	0	0
Initial Fut:	110	815	214	515	1232	689	254	876	43	124	246	241
User Adj:	1.00	1.00	1.00	1.00	1.00	1.00	1.00	1.00	1.00	1.00	1.00	1.00
PHF Adj:	1.00	1.00	1.00	1.00	1.00	1.00	1.00	1.00	1.00	1.00	1.00	1.00
PHF Volume:	110	815	214	515	1232	689	254	876	43	124	246	241
Reduct Vol:	0	0	0	0	0	0	0	0	0	0	0	0
Reduced Vol:	110	815	214	515	1232	689	254	876	43	124	246	241
PCE Adj:	1.00	1.00	1.00	1.00	1.00	1.00	1.00	1.00	1.00	1.00	1.00	1.00
MLF Adj:	1.00	1.00	1.00	1.00	1.00	1.00	1.00	1.00	1.00	1.00	1.00	1.00
Final Volume:	110	815	214	515	1232	689	254	876	43	124	246	241

Saturation Flow Module:	North Bound			South Bound			East Bound			West Bound		
Sat/Lane:	1900	1900	1900	1900	1900	1900	1900	1900	1900	1900	1900	1900
Adjustment:	0.83	0.98	0.95	0.92	1.00	0.83	0.92	0.97	0.95	0.92	1.00	0.95
Lanes:	2.00	1.57	0.43	1.00	2.00	2.00	1.00	1.90	0.10	1.00	1.00	1.00
Final Sat.:	3150	2930	769	1750	3800	3150	1750	3527	173	1750	1899	1800

Capacity Analysis Module:	North Bound			South Bound			East Bound			West Bound		
Vol/Sat:	0.03	0.28	0.28	0.29	0.32	0.22	0.15	0.25	0.25	0.07	0.13	0.13
Crit Moves:	****	****	****	****	****	****	****	****	****	****	****	****
Green Time:	10.3	30.6	30.6	32.3	52.6	52.6	18.3	27.3	27.3	7.8	16.8	16.8
Volume/Cap:	0.37	1.00	1.00	1.00	0.68	0.46	0.87	1.00	1.00	1.00	0.85	0.87
Delay/Veh:	47.6	68.0	68.0	78.7	23.2	19.4	69.0	71.3	71.3	132.2	56.5	59.9
User DelAdj:	1.00	1.00	1.00	1.00	1.00	1.00	1.00	1.00	1.00	1.00	1.00	1.00
AdjDel/Veh:	47.6	68.0	68.0	78.7	23.2	19.4	69.0	71.3	71.3	132.2	56.5	59.9
LOS by Move:	D	E	E	E-	C	B-	E	E	E	F	E+	E+
HCM2kAvgQ:	2	22	22	25	17	9	12	22	22	8	11	11

Note: Queue reported is the number of cars per lane.

San Antonio Village Phase III MTA
 SJ21-2068
 Background PM

Level Of Service Computation Report
 2000 HCM Unsignalized (Future Volume Alternative)
 Background PM

Intersection #18: Project Driveway and San Antonio Road

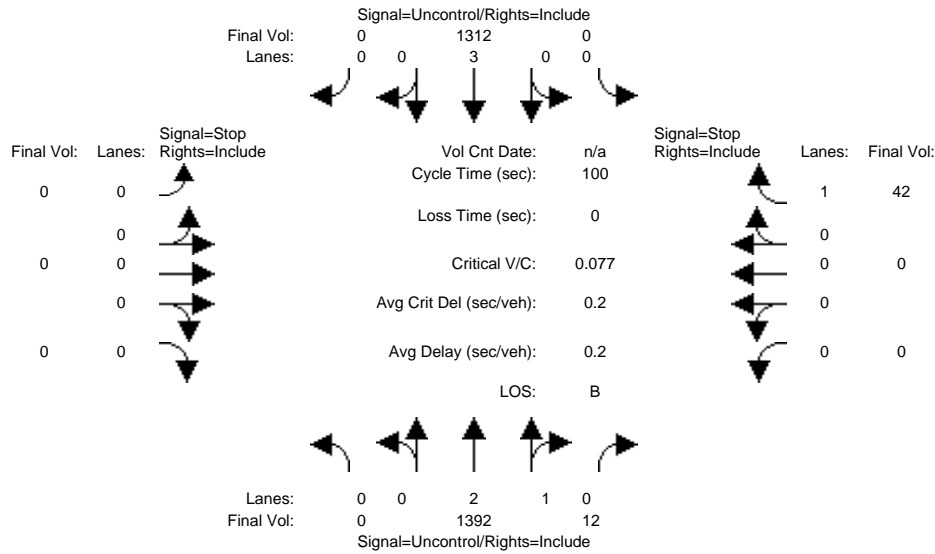

Approach:	North Bound			South Bound			East Bound			West Bound		
Movement:	L	T	R	L	T	R	L	T	R	L	T	R
Volume Module:												
Base Vol:	0	1326	12	0	1258	0	0	0	0	0	0	42
Growth Adj:	1.00	1.00	1.00	1.00	1.00	1.00	1.00	1.00	1.00	1.00	1.00	1.00
Initial Bse:	0	1326	12	0	1258	0	0	0	0	0	0	42
Added Vol:	0	66	0	0	54	0	0	0	0	0	0	0
PasserByVol:	0	0	0	0	0	0	0	0	0	0	0	0
Initial Fut:	0	1392	12	0	1312	0	0	0	0	0	0	42
User Adj:	1.00	1.00	1.00	1.00	1.00	1.00	1.00	1.00	1.00	1.00	1.00	1.00
PHF Adj:	1.00	1.00	1.00	1.00	1.00	1.00	1.00	1.00	1.00	1.00	1.00	1.00
PHF Volume:	0	1392	12	0	1312	0	0	0	0	0	0	42
Reduct Vol:	0	0	0	0	0	0	0	0	0	0	0	0
FinalVolume:	0	1392	12	0	1312	0	0	0	0	0	0	42
Critical Gap Module:												
Critical Gp:	xxxxx	xxxx	xxxxx	xxxxx	xxxx	xxxxx	xxxxx	xxxx	xxxxx	xxxxx	xxxx	6.9
FollowUpTim:	xxxxx	xxxx	xxxxx	xxxxx	xxxx	xxxxx	xxxxx	xxxx	xxxxx	xxxxx	xxxx	3.3
Capacity Module:												
Cnflct Vol:	xxxx	xxxx	xxxxx	xxxx	xxxx	xxxxx	xxxx	xxxx	xxxxx	xxxx	xxxx	470
Potent Cap.:	xxxx	xxxx	xxxxx	xxxx	xxxx	xxxxx	xxxx	xxxx	xxxxx	xxxx	xxxx	545
Move Cap.:	xxxx	xxxx	xxxxx	xxxx	xxxx	xxxxx	xxxx	xxxx	xxxxx	xxxx	xxxx	545
Volume/Cap:	xxxx	xxxx	xxxx	xxxx	xxxx	xxxx	xxxx	xxxx	xxxx	xxxx	xxxx	0.08
Level Of Service Module:												
2Way95thQ:	xxxx	xxxx	xxxxx	xxxx	xxxx	xxxxx	xxxx	xxxx	xxxxx	xxxx	xxxx	0.2
Control Del:	xxxxx	xxxx	xxxxx	xxxxx	xxxx	xxxxx	xxxxx	xxxx	xxxxx	xxxxx	xxxx	12.1
LOS by Move:	*	*	*	*	*	*	*	*	*	*	*	B
Movement:	LT	LTR	RT	LT	LTR	RT	LT	LTR	RT	LT	LTR	RT
Shared Cap.:	xxxx	xxxx	xxxxx	xxxx	xxxx	xxxxx	xxxx	xxxx	xxxxx	xxxx	xxxx	xxxxx
SharedQueue:	xxxxx	xxxx	xxxxx	xxxxx	xxxx	xxxxx	xxxxx	xxxx	xxxxx	xxxxx	xxxx	xxxxx
Shrd ConDel:	xxxxx	xxxx	xxxxx	xxxxx	xxxx	xxxxx	xxxxx	xxxx	xxxxx	xxxxx	xxxx	xxxxx
Shared LOS:	*	*	*	*	*	*	*	*	*	*	*	*
ApproachDel:	xxxxxxx			xxxxxxx			xxxxxxx			12.1		
ApproachLOS:	*			*			*			B		

Note: Queue reported is the number of cars per lane.

San Antonio Village Phase III MTA
 SJ21-2068
 Background PM

Level Of Service Computation Report
 2000 HCM Unsignalized (Future Volume Alternative)
 Background PP PM

Intersection #18: Project Driveway and San Antonio Road

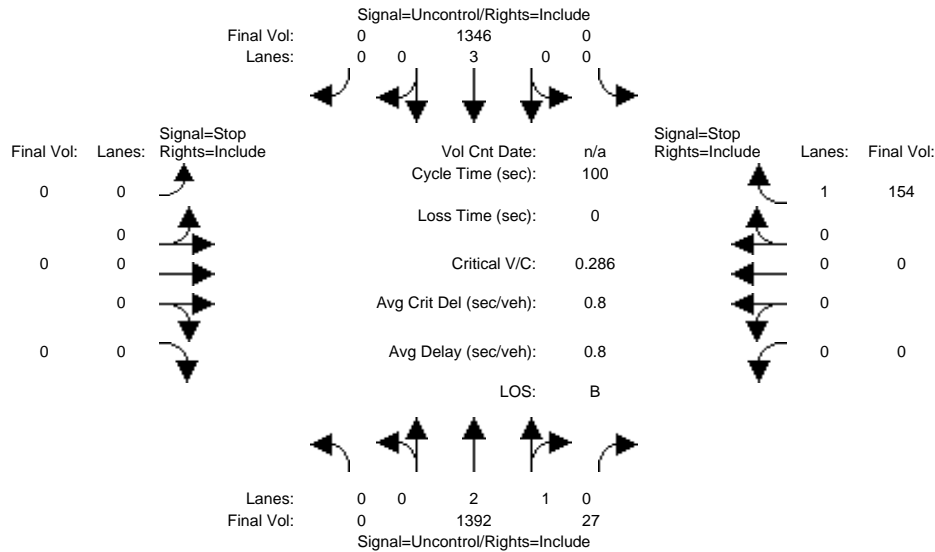

Approach:	North Bound			South Bound			East Bound			West Bound		
Movement:	L	T	R	L	T	R	L	T	R	L	T	R
Volume Module:												
Base Vol:	0	1326	12	0	1258	0	0	0	0	0	0	42
Growth Adj:	1.00	1.00	1.00	1.00	1.00	1.00	1.00	1.00	1.00	1.00	1.00	1.00
Initial Bse:	0	1326	12	0	1258	0	0	0	0	0	0	42
Added Vol:	0	66	15	0	88	0	0	0	0	0	0	112
PasserByVol:	0	0	0	0	0	0	0	0	0	0	0	0
Initial Fut:	0	1392	27	0	1346	0	0	0	0	0	0	154
User Adj:	1.00	1.00	1.00	1.00	1.00	1.00	1.00	1.00	1.00	1.00	1.00	1.00
PHF Adj:	1.00	1.00	1.00	1.00	1.00	1.00	1.00	1.00	1.00	1.00	1.00	1.00
PHF Volume:	0	1392	27	0	1346	0	0	0	0	0	0	154
Reduct Vol:	0	0	0	0	0	0	0	0	0	0	0	0
FinalVolume:	0	1392	27	0	1346	0	0	0	0	0	0	154
Critical Gap Module:												
Critical Gp:	xxxxx	xxxx	xxxxx	xxxxx	xxxx	xxxxx	xxxxx	xxxx	xxxxx	xxxxx	xxxx	6.9
FollowUpTim:	xxxxx	xxxx	xxxxx	xxxxx	xxxx	xxxxx	xxxxx	xxxx	xxxxx	xxxxx	xxxx	3.3
Capacity Module:												
Cnflct Vol:	xxxx	xxxx	xxxxx	xxxx	xxxx	xxxxx	xxxx	xxxx	xxxxx	xxxx	xxxx	478
Potent Cap.:	xxxx	xxxx	xxxxx	xxxx	xxxx	xxxxx	xxxx	xxxx	xxxxx	xxxx	xxxx	539
Move Cap.:	xxxx	xxxx	xxxxx	xxxx	xxxx	xxxxx	xxxx	xxxx	xxxxx	xxxx	xxxx	539
Volume/Cap:	xxxx	xxxx	xxxx	xxxx	xxxx	xxxx	xxxx	xxxx	xxxx	xxxx	xxxx	0.29
Level Of Service Module:												
2Way95thQ:	xxxx	xxxx	xxxxx	xxxx	xxxx	xxxxx	xxxx	xxxx	xxxxx	xxxx	xxxx	1.2
Control Del:	xxxxx	xxxx	xxxxx	xxxxx	xxxx	xxxxx	xxxxx	xxxx	xxxxx	xxxxx	xxxx	14.3
LOS by Move:	*	*	*	*	*	*	*	*	*	*	*	B
Movement:	LT	LTR	RT	LT	LTR	RT	LT	LTR	RT	LT	LTR	RT
Shared Cap.:	xxxx	xxxx	xxxxx	xxxx	xxxx	xxxxx	xxxx	xxxx	xxxxx	xxxx	xxxx	xxxxx
SharedQueue:	xxxxx	xxxx	xxxxx	xxxxx	xxxx	xxxxx	xxxxx	xxxx	xxxxx	xxxxx	xxxx	xxxxx
Shrd ConDel:	xxxxx	xxxx	xxxxx	xxxxx	xxxx	xxxxx	xxxxx	xxxx	xxxxx	xxxxx	xxxx	xxxxx
Shared LOS:	*	*	*	*	*	*	*	*	*	*	*	*
ApproachDel:	xxxxxxx			xxxxxxx			xxxxxxx					14.3
ApproachLOS:	*			*			*					B

Note: Queue reported is the number of cars per lane.

San Antonio Village Phase III MTA
SJ21-2068
Background PM

Level Of Service Computation Report
2000 HCM Unsignalized (Future Volume Alternative)
Background PM

Intersection #19: Project Driveway and California Street

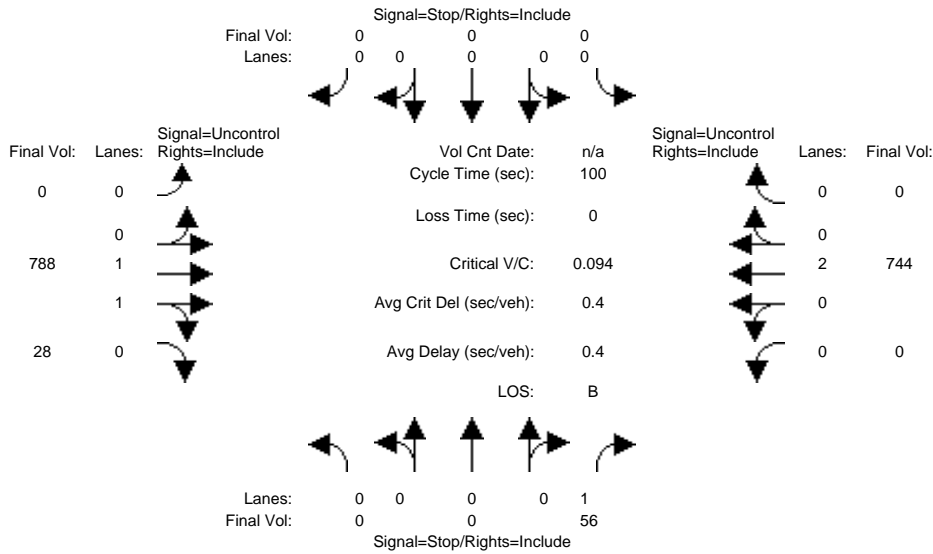

Approach:	North Bound			South Bound			East Bound			West Bound		
Movement:	L	T	R	L	T	R	L	T	R	L	T	R
Volume Module:												
Base Vol:	0	0	56	0	0	0	0	787	28	0	738	0
Growth Adj:	1.00	1.00	1.00	1.00	1.00	1.00	1.00	1.00	1.00	1.00	1.00	1.00
Initial Bse:	0	0	56	0	0	0	0	787	28	0	738	0
Added Vol:	0	0	0	0	0	0	0	1	0	0	6	0
PasserByVol:	0	0	0	0	0	0	0	0	0	0	0	0
Initial Fut:	0	0	56	0	0	0	0	788	28	0	744	0
User Adj:	1.00	1.00	1.00	1.00	1.00	1.00	1.00	1.00	1.00	1.00	1.00	1.00
PHF Adj:	1.00	1.00	1.00	1.00	1.00	1.00	1.00	1.00	1.00	1.00	1.00	1.00
PHF Volume:	0	0	56	0	0	0	0	788	28	0	744	0
Reduct Vol:	0	0	0	0	0	0	0	0	0	0	0	0
FinalVolume:	0	0	56	0	0	0	0	788	28	0	744	0
Critical Gap Module:												
Critical Gp:	xxxxx	xxxx	6.9	xxxxx	xxxx	xxxxx	xxxxxx	xxxx	xxxxxx	xxxxxx	xxxx	xxxxxx
FollowUpTim:	xxxxxx	xxxx	3.3	xxxxxx	xxxx	xxxxxx	xxxxxx	xxxx	xxxxxx	xxxxxx	xxxx	xxxxxx
Capacity Module:												
Cnflct Vol:	xxxx	xxxx	408	xxxx	xxxx	xxxxxx	xxxx	xxxx	xxxxxx	xxxx	xxxx	xxxxxx
Potent Cap.:	xxxx	xxxx	598	xxxx	xxxx	xxxxxx	xxxx	xxxx	xxxxxx	xxxx	xxxx	xxxxxx
Move Cap.:	xxxx	xxxx	598	xxxx	xxxx	xxxxxx	xxxx	xxxx	xxxxxx	xxxx	xxxx	xxxxxx
Volume/Cap:	xxxx	xxxx	0.09	xxxx	xxxx	xxxx	xxxx	xxxx	xxxx	xxxx	xxxx	xxxx
Level Of Service Module:												
2Way95thQ:	xxxx	xxxx	0.3	xxxx	xxxx	xxxxxx	xxxx	xxxx	xxxxxx	xxxx	xxxx	xxxxxx
Control Del:	xxxxxx	xxxx	11.6	xxxxxx	xxxx	xxxxxx	xxxxxx	xxxx	xxxxxx	xxxxxx	xxxx	xxxxxx
LOS by Move:	*	*	B	*	*	*	*	*	*	*	*	*
Movement:	LT	LTR	RT	LT	LTR	RT	LT	LTR	RT	LT	LTR	RT
Shared Cap.:	xxxx	xxxx	xxxxxx	xxxx	xxxx	xxxxxx	xxxx	xxxx	xxxxxx	xxxx	xxxx	xxxxxx
SharedQueue:	xxxxxx	xxxx	xxxxxx	xxxxxx	xxxx	xxxxxx	xxxxxx	xxxx	xxxxxx	xxxxxx	xxxx	xxxxxx
Shrd ConDel:	xxxxxx	xxxx	xxxxxx	xxxxxx	xxxx	xxxxxx	xxxxxx	xxxx	xxxxxx	xxxxxx	xxxx	xxxxxx
Shared LOS:	*	*	*	*	*	*	*	*	*	*	*	*
ApproachDel:	11.6			xxxxxxx			xxxxxxx			xxxxxxx		
ApproachLOS:	B			*			*			*		

Note: Queue reported is the number of cars per lane.

San Antonio Village Phase III MTA
SJ21-2068
Background PM

Level Of Service Computation Report
2000 HCM Unsignalized (Future Volume Alternative)
Background PP PM

Intersection #19: Project Driveway and California Street

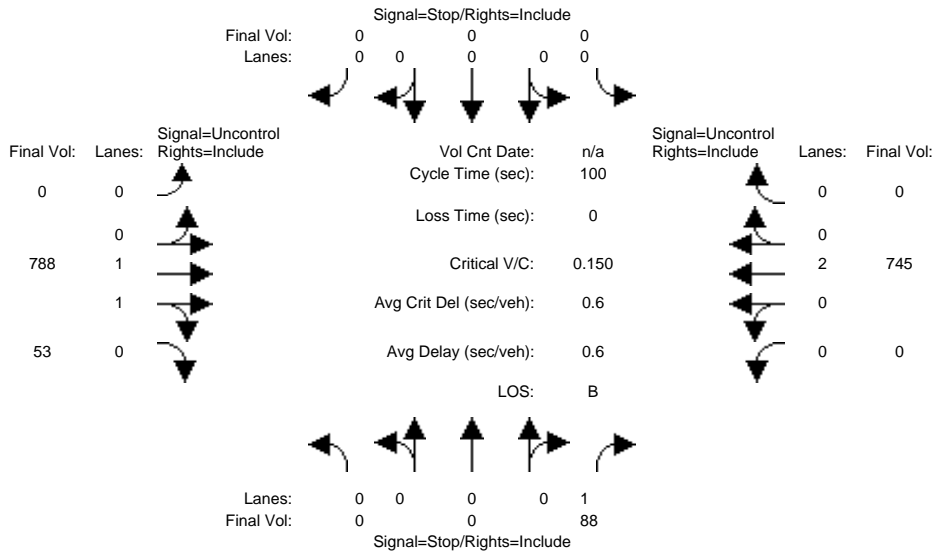

Approach:	North Bound			South Bound			East Bound			West Bound		
Movement:	L	T	R	L	T	R	L	T	R	L	T	R
Volume Module:												
Base Vol:	0	0	56	0	0	0	0	787	28	0	738	0
Growth Adj:	1.00	1.00	1.00	1.00	1.00	1.00	1.00	1.00	1.00	1.00	1.00	1.00
Initial Bse:	0	0	56	0	0	0	0	787	28	0	738	0
Added Vol:	0	0	32	0	0	0	0	1	25	0	7	0
PasserByVol:	0	0	0	0	0	0	0	0	0	0	0	0
Initial Fut:	0	0	88	0	0	0	0	788	53	0	745	0
User Adj:	1.00	1.00	1.00	1.00	1.00	1.00	1.00	1.00	1.00	1.00	1.00	1.00
PHF Adj:	1.00	1.00	1.00	1.00	1.00	1.00	1.00	1.00	1.00	1.00	1.00	1.00
PHF Volume:	0	0	88	0	0	0	0	788	53	0	745	0
Reduct Vol:	0	0	0	0	0	0	0	0	0	0	0	0
FinalVolume:	0	0	88	0	0	0	0	788	53	0	745	0
Critical Gap Module:												
Critical Gp:	xxxxx	xxxx	6.9	xxxxx	xxxx	xxxxx	xxxxx	xxxx	xxxxx	xxxxx	xxxx	xxxxx
FollowUpTim:	xxxxx	xxxx	3.3	xxxxx	xxxx	xxxxx	xxxxx	xxxx	xxxxx	xxxxx	xxxx	xxxxx
Capacity Module:												
Cnflct Vol:	xxxx	xxxx	421	xxxx	xxxx	xxxxx	xxxx	xxxx	xxxxx	xxxx	xxxx	xxxxx
Potent Cap.:	xxxx	xxxx	587	xxxx	xxxx	xxxxx	xxxx	xxxx	xxxxx	xxxx	xxxx	xxxxx
Move Cap.:	xxxx	xxxx	587	xxxx	xxxx	xxxxx	xxxx	xxxx	xxxxx	xxxx	xxxx	xxxxx
Volume/Cap:	xxxx	xxxx	0.15	xxxx	xxxx	xxxx	xxxx	xxxx	xxxx	xxxx	xxxx	xxxx
Level Of Service Module:												
2Way95thQ:	xxxx	xxxx	0.5	xxxx	xxxx	xxxxx	xxxx	xxxx	xxxxx	xxxx	xxxx	xxxxx
Control Del:	xxxxx	xxxx	12.2	xxxxx	xxxx	xxxxx	xxxxx	xxxx	xxxxx	xxxxx	xxxx	xxxxx
LOS by Move:	*	*	B	*	*	*	*	*	*	*	*	*
Movement:	LT	LTR	RT	LT	LTR	RT	LT	LTR	RT	LT	LTR	RT
Shared Cap.:	xxxx	xxxx	xxxxx	xxxx	xxxx	xxxxx	xxxx	xxxx	xxxxx	xxxx	xxxx	xxxxx
SharedQueue:	xxxxx	xxxx	xxxxx	xxxxx	xxxx	xxxxx	xxxxx	xxxx	xxxxx	xxxxx	xxxx	xxxxx
Shrd ConDel:	xxxxx	xxxx	xxxxx	xxxxx	xxxx	xxxxx	xxxxx	xxxx	xxxxx	xxxxx	xxxx	xxxxx
Shared LOS:	*	*	*	*	*	*	*	*	*	*	*	*
ApproachDel:	12.2			xxxxxxx			xxxxxxx			xxxxxxx		
ApproachLOS:	B			*			*			*		

Note: Queue reported is the number of cars per lane.

Appendix D: Freeway Screening Analysis

Table D-1: AM and PM Freeway LOS

2018 Freeway LOS AM														
Facility	Dir	From/To	From/To	Number of Lanes			LOS		Capacity		Project Trips		> 1% Volume Increase?	
				Total	Mixed	HOV	Mixed	HOV	Mixed	HOV	Mixed	HOV	Mixed	HOV
US 101 -- Southbound														
US 101	SB	Oregon Expy.	San Antonio Rd.	5	3	2	D	A	6900	3300	18	3	No	No
US 101	SB	San Antonio Rd.	Rengstorff Av.	5	3	2	E	A	6900	3300	2	0	No	No
US 101	SB	Rengstorff Av.	Shoreline Blvd.	5	3	2	D	C	6900	3300	3	1	No	No
US 101	SB	Shoreline Blvd.	SR 85	4	3	1	D	A	6900	1650	3	1	No	No
US 101 -- Northbound														
US 101	NB	SR 85	Shoreline Blvd.	6	4	2	F	E	9200	3300	24	4	No	No
US 101	NB	Shoreline Blvd.	Rengstorff Av.	6	4	2	F	D	9200	3300	24	4	No	No
US 101	NB	Rengstorff Av.	San Antonio Rd.	5	3	2	E	D	6900	3300	12	2	No	No
US 101	NB	San Antonio Rd.	Oregon Expy.	5	3	2	F	E	6900	3300	3	0	No	No
2018 Freeway LOS PM														
Facility	Dir	From/To	From/To	Number of Lanes			LOS		Capacity		Project Trips		> 1% Volume Increase?	
				Total	Mixed	HOV	Mixed	HOV	Mixed	HOV	Mixed	HOV	Mixed	HOV
US 101 -- Southbound														
US 101	SB	Oregon Expy.	San Antonio Rd.	5	3	2	F	D	6900	3300	5	1	No	No
US 101	SB	San Antonio Rd.	Rengstorff Av.	5	3	2	F	D	6900	3300	12	2	No	No
US 101	SB	Rengstorff Av.	Shoreline Blvd.	5	3	2	F	D	6900	3300	24	4	No	No
US 101	SB	Shoreline Blvd.	SR 85	4	3	1	F	E	6900	1650	24	4	No	No
US 101 -- Northbound														
US 101	NB	SR 85	Shoreline Blvd.	6	4	2	F	D	9200	3300	7	1	No	No
US 101	NB	Shoreline Blvd.	Rengstorff Av.	6	4	2	F	D	9200	3300	7	1	No	No
US 101	NB	Rengstorff Av.	San Antonio Rd.	5	3	2	F	D	6900	3300	3	1	No	No
US 101	NB	San Antonio Rd.	Oregon Expy.	5	3	2	F	F	6900	3300	18	3	No	No

Appendix E: San Antonio Precise Plan Intersection Volume and Trip Generation Comparison

Table 1: San Antonio Village Phase III MTA AM Peak Hour Existing Volumes

North/South	East/West	Northbound				Southbound				Eastbound				Westbound				Grand Total
		Left	Thru	Right	Total	Left	Thru	Right	Total	Left	Thru	Right	Total	Left	Thru	Right	Total	
Arastradero Rd-Charleston Rd	El Camino Real	175	359	173	707	98	543	213	854	140	604	177	921	351	951	155	1457	3939
Del Medio Avenue	El Camino Real	0	0	0	0	59	0	186	245	121	762	0	883	63	1165	121	1349	2477
San Antonio Road	El Camino Real	199	631	70	900	247	675	167	1089	241	594	149	984	366	968	199	1533	4506
Showers Drive	El Camino Real	15	11	17	43	140	18	129	287	213	832	81	1126	53	1231	182	1466	2922
Ortega Avenue	El Camino Real	2	0	0	2	121	0	66	187	31	951	4	986	26	1441	145	1612	2787
Rengstorff Avenue	El Camino Real	0	0	0	0	359	2	182	543	55	1064	0	1119	52	1575	256	1883	3545
San Antonio Road	California Street	50	902	68	1020	340	1141	145	1626	289	68	26	383	101	61	377	539	3568
Pacchetti Way	California Street	77	9	11	97	13	9	90	112	39	245	127	411	13	370	6	389	1009
Showers Drive	California Street	110	53	75	238	28	90	59	177	17	199	64	280	151	293	28	472	1167
Ortega Avenue	California Street	57	64	50	171	68	61	26	155	7	270	53	330	22	412	48	482	1138
Rengstorff Avenue	California Street	44	372	33	449	173	385	197	755	153	250	70	473	39	272	204	515	2192
Rengstorff Avenue	Central Expressway	180	550	99	829	63	429	79	571	64	456	112	632	270	1264	175	1709	3741
San Antonio Road	Middlefield Road	370	914	386	1670	118	1005	81	1204	72	370	294	736	495	569	129	1193	4803

Table 2A: Counted Volumes used in the San Antonio Precise Plan EIR

North/South	East/West	Northbound				Southbound				Eastbound				Westbound				Grand Total
		Left	Thru	Right	Total	Left	Thru	Right	Total	Left	Thru	Right	Total	Left	Thru	Right	Total	
Arastradero Rd-Charleston Rd	El Camino Real	190	341	3	534	94	290	180	564	132	743	153	1028	406	1713	140	2259	4385
Del Medio Avenue	El Camino Real	4	0	2	6	89	4	296	389	120	1085	8	1213	113	1595	76	1784	3392
San Antonio Road	El Camino Real	236	791	48	1075	185	780	243	1208	351	645	152	1148	251	1212	134	1597	5028
Showers Drive	El Camino Real	10	2	12	24	104	19	96	219	195	922	68	1185	37	1459	130	1626	3054
Ortega Avenue	El Camino Real	0	1	1	2	86	7	31	124	33	1041	8	1082	35	1642	114	1791	2999
Rengstorff Avenue	El Camino Real	2	0	0	2	238	12	164	414	133	1053	3	1189	68	1657	229	1954	3559
San Antonio Road	California Street	40	1195	81	1316	230	976	125	1331	221	53	27	301	166	109	356	631	3579
Pacchetti Way	California Street	80	4	14	98	7	5	76	88	12	209	109	330	20	519	3	542	1058
Showers Drive	California Street	135	31	55	221	35	74	65	174	9	163	84	256	91	365	18	474	1125
Ortega Avenue	California Street	41	26	23	90	58	56	19	133	8	224	34	266	50	437	31	518	1007
Rengstorff Avenue	California Street	37	346	38	421	72	267	123	462	109	207	58	374	40	353	127	520	1777
Rengstorff Avenue	Central Expressway	212	539	107	858	81	379	97	557	101	1121	63	1285	109	1317	116	1542	4242
San Antonio Road	Middlefield Road	310	1021	181	1512	106	650	25	781	133	401	177	711	259	566	317	1142	4146

Table 2B: Difference between Recent Counts and Counted Volumes used in the San Antonio Precise Plan EIR

North/South	East/West	Northbound				Southbound				Eastbound				Westbound				Grand Total
		Left	Thru	Right	Total	Left	Thru	Right	Total	Left	Thru	Right	Total	Left	Thru	Right	Total	
Arastradero Rd-Charleston Rd	El Camino Real	15	-18	-170	-173	-4	-253	-33	-290	-8	139	-24	107	55	762	-15	802	446
Del Medio Avenue	El Camino Real	4	0	2	6	30	4	110	144	-1	323	8	330	50	430	-45	435	915
San Antonio Road	El Camino Real	37	160	-22	175	-62	105	76	119	110	51	3	164	-115	244	-65	64	522
Showers Drive	El Camino Real	-5	-9	-5	-19	-36	1	-33	-68	-18	90	-13	59	-16	228	-52	160	132
Ortega Avenue	El Camino Real	-2	1	1	0	-35	7	-35	-63	2	90	4	96	9	201	-31	179	212
Rengstorff Avenue	El Camino Real	2	0	0	2	-121	10	-18	-129	78	-11	3	70	16	82	-27	71	14
San Antonio Road	California Street	-10	293	13	296	-110	-165	-20	-295	-68	-15	1	-82	65	48	-21	92	11
Pacchetti Way	California Street	3	-5	3	1	-6	-4	-14	-24	-27	-36	-18	-81	7	149	-3	153	49
Showers Drive	California Street	25	-22	-20	-17	7	-16	6	-3	-8	-36	20	-24	-60	72	-10	2	-42
Ortega Avenue	California Street	-16	-38	-27	-81	-10	-5	-7	-22	1	-46	-19	-64	28	25	-17	36	-131
Rengstorff Avenue	California Street	-7	-26	5	-28	-101	-118	-74	-293	-44	-43	-12	-99	1	81	-77	5	-415
Rengstorff Avenue	Central Expressway	32	-11	8	29	18	-50	18	-14	37	665	-49	653	-161	53	-59	-167	501
San Antonio Road	Middlefield Road	-60	107	-205	-158	-12	-355	-56	-423	61	31	-117	-25	-236	-3	188	-51	-657

Note: Difference is calculated as Recent Counts (from Table 1) - Counted Volumes from the San Antonio Precise Plan EIR (from Table 2A). A negative value indicates the San Antonio Precise Plan counts are less than recent counts.

Table 2C: Percent Difference between Recent Counts and Counted Volumes used in the San Antonio Precise Plan EIR (Only showing for turn movements greater than 150 vehicles)

North/South	East/West	Northbound				Southbound				Eastbound				Westbound				Grand Total	
		Left	Thru	Right	Total	Left	Thru	Right	Total	Left	Thru	Right	Total	Left	Thru	Right	Total		
Arastradero Rd-Charleston Rd	El Camino Real	8%	-5%		-32%		-87%	-18%	-51%		19%	-16%	10%	14%	44%		36%	10%	
Del Medio Avenue	El Camino Real						30%	37%			30%		27%				24%	27%	
San Antonio Road	El Camino Real	16%	20%		16%	-34%	13%	31%	10%	31%	8%	2%	14%	-46%	20%		4%	10%	
Showers Drive	El Camino Real								-31%		10%		5%		16%		10%	4%	
Ortega Avenue	El Camino Real									9%		9%		12%		10%	7%		
Rengstorff Avenue	El Camino Real					-51%		-11%	-31%		-1%		6%		5%	-12%	4%	0%	
San Antonio Road	California Street		25%		22%	-48%	-17%		-22%	-31%			-27%	39%		-6%	15%	0%	
Pacchetti Way	California Street										-17%		-25%		29%		28%	5%	
Showers Drive	California Street				-8%				-2%				-9%		20%		0%	-4%	
Ortega Avenue	California Street										-21%		-24%		6%		7%	-13%	
Rengstorff Avenue	California Street		-8%		-7%		-44%		-63%		-21%		-26%		23%		1%	-23%	
Rengstorff Avenue	Central Expressway		15%	-2%	3%		-13%		-3%		59%		51%		4%		-11%	12%	
San Antonio Road	Middlefield Road		-19%	10%	-113%	-10%		-55%		-54%		8%	-66%	-4%	-91%	-1%	59%	-4%	-16%

Note: Percent Difference is calculated as Difference between Recent Counts and Counted Volumes from the San Antonio Precise Plan EIR (from Table 2B) divided by Counted Volume in San Antonio Precise Plan EIR (from Table 2A).

Table 3A: Cumulative Volumes used in the San Antonio Precise Plan EIR

North/South	East/West	Northbound				Southbound				Eastbound				Westbound				Grand Total
		Left	Thru	Right	Total	Left	Thru	Right	Total	Left	Thru	Right	Total	Left	Thru	Right	Total	
Arastradero Rd-Charleston Rd	El Camino Real	223	479	423	1125	177	290	236	703	293	2003	192	2488	406	1873	182	2461	6777
Del Medio Avenue	El Camino Real	114	0	8	122	89	7	364	460	173	2365	183	2721	173	1621	76	1870	5173
San Antonio Road	El Camino Real	240	1300	108	1648	574	1005	325	1904	639	1629	163	2431	251	1212	139	1602	7585
Showers Drive	El Camino Real	10	2	12	24	335	19	102	456	573	1973	68	2614	37	1459	172	1668	4762
Ortega Avenue	El Camino Real	0	1	1	2	221	7	71	299	174	2375	8	2557	35	1642	149	1826	4684
Rengstorff Avenue	El Camino Real	2	0	0	2	291	12	187	490	349	2305	3	2657	68	1658	289	2015	5164
San Antonio Road	California Street	40	1313	542	1895	976	1325	125	2426	221	93	27	341	433	114	487	1034	5696
Pacchetti Way	California Street	80	4	29	113	28	23	29	80	16	1397	167	1580	39	897	3	939	2712
Showers Drive	California Street	300	91	232	623	122	93	121	336	45	1204	208	1457	93	547	34	674	3090
Ortega Avenue	California Street	90	28	111	229	94	69	19	182	11	1413	158	1582	102	568	31	701	2694
Rengstorff Avenue	California Street	90	667	143	900	184	392	206	782	314	1191	183	1688	42	423	127	592	3962
Rengstorff Avenue	Central Expressway	229	877	145	1251	151	633	142	926	186	1714	87	1987	124	1317	173	1614	5778
San Antonio Road	Middlefield Road	392	1115	181	1688	106	1012	46	1164	451	467	592	1510	259	649	317	1225	5587

Table 3B: Difference between Recent Counts and Cumulative Volumes used in the San Antonio Precise Plan EIR

North/South	East/West	Northbound				Southbound				Eastbound				Westbound				Grand Total
		Left	Thru	Right	Total	Left	Thru	Right	Total	Left	Thru	Right	Total	Left	Thru	Right	Total	
Arastradero Rd-Charleston Rd	El Camino Real	48	120	250	418	79	-253	23	-151	153	1399	15	1567	55	922	27	1004	2838
Del Medio Avenue	El Camino Real	114	0	8	122	30	7	178	215	52	1603	183	1838	110	456	-45	521	2696
San Antonio Road	El Camino Real	41	669	38	748	327	330	158	815	398	1035	14	1447	-115	244	-60	69	3079
Showers Drive	El Camino Real	-5	-9	-5	-19	195	1	-27	169	360	1141	-13	1488	-16	228	-10	202	1840
Ortega Avenue	El Camino Real	-2	1	1	0	100	7	5	112	143	1424	4	1571	9	201	4	214	1897
Rengstorff Avenue	El Camino Real	2	0	0	2	-68	10	5	-53	294	1241	3	1538	16	83	33	132	1619
San Antonio Road	California Street	-10	411	474	875	636	184	-20	800	-68	25	1	-42	332	53	110	495	2128
Pacchetti Way	California Street	3	-5	18	16	15	14	-61	-32	-23	1152	40	1169	26	527	-3	550	1703
Showers Drive	California Street	190	38	157	385	94	3	62	159	28	1005	144	1177	-58	254	6	202	1923
Ortega Avenue	California Street	33	-36	61	58	26	8	-7	27	4	1143	105	1252	80	156	-17	219	1556
Rengstorff Avenue	California Street	46	295	110	451	11	7	9	27	161	941	113	1215	3	151	-77	77	1770
Rengstorff Avenue	Central Expressway	49	327	46	422	88	204	63	355	122	1258	-25	1355	-146	53	-2	-95	2037
San Antonio Road	Middlefield Road	22	201	-205	18	-12	7	-35	-40	379	97	298	774	-236	80	188	32	784

Note: Difference is calculated as Cumulative Volumes (from Table 3A) - Counted Volumes from the San Antonio Precise Plan EIR (from Table 2A). A negative value indicates the San Antonio Precise Plan counts are less than recent counts.

Table 3C: Percent Difference between 2020 Volumes and Counted Volumes used in the City Place Santa Clara EIR (Only showing for turn movements greater than 150 vehicles)

North/South	East/West	Northbound				Southbound				Eastbound				Westbound				Grand Total
		Left	Thru	Right	Total	Left	Thru	Right	Total	Left	Thru	Right	Total	Left	Thru	Right	Total	
Arastradero Rd-Charleston Rd	El Camino Real	22%	25%	59%	37%	45%	-87%	10%	-21%	52%	70%	8%	63%	14%	49%	15%	41%	42%
Del Medio Avenue	El Camino Real							49%	47%	30%	68%	100%	68%	64%	28%		28%	52%
San Antonio Road	El Camino Real	17%	51%		45%	57%	33%	49%	43%	62%	64%	9%	60%	-46%	20%		4%	41%
Showers Drive	El Camino Real					58%			37%	63%	58%		57%		16%	-6%	12%	39%
Ortega Avenue	El Camino Real					45%			37%	82%	60%		61%		12%		12%	40%
Rengstorff Avenue	El Camino Real					-23%		3%	-11%	84%	54%		58%		5%	11%	7%	31%
San Antonio Road	California Street		31%	87%	46%	65%	14%		33%	-31%			-12%	77%		23%	48%	37%
Pacchetti Way	California Street										82%	24%	74%		59%		59%	63%
Showers Drive	California Street	63%		68%	62%				47%		83%	69%	81%		46%		30%	62%
Ortega Avenue	California Street				25%				15%		81%	66%	79%		27%		31%	58%
Rengstorff Avenue	California Street		44%		50%	6%	2%	4%	3%	51%	79%	62%	72%		36%		13%	45%
Rengstorff Avenue	Central Expressway	21%	37%		34%	58%	32%		38%	66%	73%		68%		4%	-1%	-6%	35%
San Antonio Road	Middlefield Road	6%	18%	-113%	1%		1%		-3%	84%	21%	50%	51%	-91%	12%	59%	3%	14%

Note: Percent Difference is calculated as Difference between 2020 Volumes and Counted Volumes from the San Antonio Precise Plan EIR (from Table 3B) divided by Counted Volume in San Antonio Precise Plan EIR (from Table 2A).

Table 4: San Antonio Village Phase III MTA PM Peak Hour Existing Volumes

North/South	East/West	PM Peak Hour																Grand Total
		Northbound				Southbound				Eastbound				Westbound				
		Left	Thru	Right	Total	Left	Thru	Right	Total	Left	Thru	Right	Total	Left	Thru	Right	Total	
Arastradero Rd-Charleston Rd	El Camino Real	148	470	461	1079	159	319	176	654	194	1154	181	1529	272	883	189	1344	4606
Del Medio Avenue	El Camino Real	0	2	0	2	46	0	95	141	113	1630	2	1745	91	1139	133	1363	3251
San Antonio Road	El Camino Real	179	687	88	954	364	613	166	1143	420	1179	203	1802	402	923	222	1547	5446
Showers Drive	El Camino Real	63	15	73	151	264	37	176	477	320	1489	100	1909	101	1130	216	1447	3984
Ortega Avenue	El Camino Real	5	3	3	11	75	3	55	133	71	1798	0	1869	12	1270	113	1395	3408
Rengstorff Avenue	El Camino Real	3	0	0	3	364	0	136	500	196	1642	0	1838	123	1378	352	1853	4194
San Antonio Road	California Street	40	1232	96	1368	613	1157	234	2004	227	106	25	358	76	71	591	738	4468
Pacchetti Way	California Street	209	10	40	259	7	7	80	94	20	518	236	774	38	455	5	498	1625
Showers Drive	California Street	163	46	239	448	85	71	55	211	20	403	110	533	173	322	28	523	1715
Ortega Avenue	California Street	35	27	70	132	60	30	22	112	13	730	70	813	33	471	55	559	1616
Rengstorff Avenue	California Street	45	485	63	593	229	500	234	963	302	476	85	863	40	302	134	476	2895
Rengstorff Avenue	Central Expressway	113	621	251	985	103	603	90	796	158	1125	163	1446	269	666	158	1093	4320
San Antonio Road	Middlefield Road	232	1107	390	1729	214	1162	110	1486	113	480	281	874	452	335	133	920	5009

Table 5A: Counted Volumes used in the San Antonio Precise Plan EIR

North/South	East/West	PM Peak Hour																Grand Total
		Northbound				Southbound				Eastbound				Westbound				
		Left	Thru	Right	Total	Left	Thru	Right	Total	Left	Thru	Right	Total	Left	Thru	Right	Total	
Arastradero Rd-Charleston Rd	El Camino Real	176	300	509	985	165	290	123	578	120	1768	184	2072	298	1073	102	1473	5108
Del Medio Avenue	El Camino Real	5	3	19	27	48	0	102	150	129	2038	2	2169	62	1243	129	1434	3780
San Antonio Road	El Camino Real	181	519	123	823	357	757	263	1377	566	1611	236	2413	338	862	159	1359	5972
Showers Drive	El Camino Real	68	29	98	195	232	34	151	417	300	1572	164	2036	89	1087	229	1405	4053
Ortega Avenue	El Camino Real	11	3	13	27	74	5	54	133	42	1952	7	2001	22	1346	79	1447	3608
Rengstorff Avenue	El Camino Real	13	8	6	27	302	2	146	450	224	2012	5	2241	67	1229	205	1501	4219
San Antonio Road	California Street	70	1027	155	1252	394	1091	155	1640	151	123	22	296	135	88	389	612	3800
Pacchetti Way	California Street	176	9	55	240	24	23	25	72	19	418	208	645	40	492	17	549	1506
Showers Drive	California Street	203	41	162	406	79	61	31	171	13	419	79	511	130	341	32	503	1591
Ortega Avenue	California Street	50	27	44	121	51	29	19	99	49	629	20	698	31	461	41	533	1451
Rengstorff Avenue	California Street	58	279	67	404	167	398	170	735	151	504	68	723	49	396	96	541	2403
Rengstorff Avenue	Central Expressway	109	391	118	618	148	471	41	660	119	1256	135	1510	144	1135	140	1419	4207
San Antonio Road	Middlefield Road	276	814	248	1338	220	1051	80	1351	96	545	268	909	291	792	143	1226	4824

Table 5B: Difference between Recent Counts and Counted Volumes used in the San Antonio Precise Plan EIR

North/South	East/West	PM Peak Hour																Grand Total
		Northbound				Southbound				Eastbound				Westbound				
		Left	Thru	Right	Total	Left	Thru	Right	Total	Left	Thru	Right	Total	Left	Thru	Right	Total	
Arastradero Rd-Charleston Rd	El Camino Real	28	-170	48	-94	6	-29	-53	-76	-74	614	3	543	26	190	-87	129	502
Del Medio Avenue	El Camino Real	5	1	19	25	2	0	7	9	16	408	0	424	-29	104	-4	71	529
San Antonio Road	El Camino Real	2	-168	35	-131	-7	144	97	234	146	432	33	611	-64	-61	-63	-188	526
Showers Drive	El Camino Real	5	14	25	44	-32	-3	-25	-60	-20	83	64	127	-12	-43	13	-42	69
Ortega Avenue	El Camino Real	6	0	10	16	-1	2	-1	0	-29	154	7	132	10	76	-34	52	200
Rengstorff Avenue	El Camino Real	10	8	6	24	-62	2	10	-50	28	370	5	403	-56	-149	-147	-352	25
San Antonio Road	California Street	30	-205	59	-116	-219	-66	-79	-364	-76	17	-3	-62	59	17	-202	-126	-668
Pacchetti Way	California Street	-33	-1	15	-19	17	16	-55	-22	-1	-100	-28	-129	2	37	12	51	-119
Showers Drive	California Street	40	-5	-77	-42	-6	-10	-24	-40	-7	16	-31	-22	-43	19	4	-20	-124
Ortega Avenue	California Street	15	0	-26	-11	-9	-1	-3	-13	36	-101	-50	-115	-2	-10	-14	-26	-165
Rengstorff Avenue	California Street	13	-206	4	-189	-62	-102	-64	-228	-151	28	-17	-140	9	94	-38	65	-492
Rengstorff Avenue	Central Expressway	-4	-230	-133	-367	45	-132	-49	-136	-39	131	-28	64	-125	469	-18	326	-113
San Antonio Road	Middlefield Road	44	-293	-142	-391	6	-111	-30	-135	-17	65	-13	35	-161	457	10	306	-185

Note: Difference is calculated as Recent Counts (from Table 4) - Counted Volumes from the San Antonio Precise Plan EIR (from Table 5A). A negative value indicates the San Antonio Precise Plan counts are less than recent counts.

Table 5C: Percent Difference between Recent Counts and Counted Volumes used in the San Antonio Precise Plan EIR (Only showing for turn movements greater than 150 vehicles)

North/South	East/West	PM Peak Hour																Grand Total
		Northbound				Southbound				Eastbound				Westbound				
		Left	Thru	Right	Total	Left	Thru	Right	Total	Left	Thru	Right	Total	Left	Thru	Right	Total	
Arastradero Rd-Charleston Rd	El Camino Real	16%	-57%	9%	-10%	4%	-10%		-13%		35%	2%	26%	9%	18%		9%	10%
Del Medio Avenue	El Camino Real										20%		20%		8%		5%	14%
San Antonio Road	El Camino Real	1%	-32%		-16%	-2%	19%	37%	17%	26%	27%	14%	25%	-19%	-7%	-40%	-14%	9%
Showers Drive	El Camino Real				23%	-14%		-17%	-14%	-7%	5%	39%	6%		-4%	6%	-3%	2%
Ortega Avenue	El Camino Real										8%		7%		6%		4%	6%
Rengstorff Avenue	El Camino Real								-11%	13%	18%		18%		-12%	-72%	-23%	1%
San Antonio Road	California Street		-20%	38%	-9%	-56%	-6%	-51%	-22%	-50%			-21%			-52%	-21%	-18%
Pacchetti Way	California Street	-19%			-8%						-24%	-13%	-20%		8%		9%	-8%
Showers Drive	California Street	20%		-48%	-10%				-23%		4%		-4%		6%		-4%	-8%
Ortega Avenue	California Street										-16%		-16%		-2%		-5%	-11%
Rengstorff Avenue	California Street				-47%	-37%	-26%	-38%	-31%	-100%	6%		-19%		24%		12%	-20%
Rengstorff Avenue	Central Expressway				-59%				-21%		10%		4%		41%		23%	-3%
San Antonio Road	Middlefield Road	16%	-36%	-57%	-29%	3%	-11%		-10%		12%	-5%	4%	-55%	58%		25%	-4%

Note: Percent Difference is calculated as Difference between Recent Counts and Counted Volumes from the San Antonio Precise Plan EIR (from Table 5B) divided by Counted Volume in San Antonio Precise Plan EIR (from Table 5A).

Table 6A: Cumulative Volumes used in the San Antonio Precise Plan EIR

North/South	East/West	PM Peak Hour																Grand Total
		Northbound				Southbound				Eastbound				Westbound				
		Left	Thru	Right	Total	Left	Thru	Right	Total	Left	Thru	Right	Total	Left	Thru	Right	Total	
Arastradero Rd-Charleston Rd	El Camino Real	241	468	509	1218	254	690	386	1330	290	1899	297	2486	535	2520	279	3334	8368
Del Medio Avenue	El Camino Real	8	3	19	30	48	0	261	309	315	2060	4	2379	71	2933	184	3188	5906
San Antonio Road	El Camino Real	207	807	123	1137	624	757	631	2012	595	1611	236	2442	340	2214	576	3130	8721
Showers Drive	El Camino Real	68	29	98	195	281	34	363	678	482	1648	164	2294	89	2652	436	3177	6344
Ortega Avenue	El Camino Real	11	3	13	27	88	5	79	172	42	2008	7	2057	22	3102	119	3243	5499
Rengstorff Avenue	El Camino Real	13	9	6	28	377	4	820	1201	306	2012	5	2323	67	2346	538	2951	6503
San Antonio Road	California Street	85	1346	436	1867	1022	1212	176	2410	160	272	22	454	346	232	1109	1687	6418
Pacchetti Way	California Street	269	9	85	363	28	23	29	80	19	1434	258	1711	45	1490	17	1552	3706
Showers Drive	California Street	286	41	242	569	94	61	35	190	24	1408	135	1567	254	1234	67	1555	3881
Ortega Avenue	California Street	79	27	70	176	55	29	20	104	30	1688	50	1768	37	1500	75	1612	3660
Rengstorff Avenue	California Street	196	543	174	2720	167	711	170	3580	262	1165	397	820	347	1336	199	1630	8750
Rengstorff Avenue	Central Expressway	240	740	153	1133	167	850	77	1094	132	1256	165	1553	211	1737	186	2134	5914
San Antonio Road	Middlefield Road	671	1150	248	2069	220	1209	319	1748	395	586	536	1517	291	815	143	1249	6583

Table 6B: Difference between Recent Counts and Cumulative Volumes used in the San Antonio Precise Plan EIR

North/South	East/West	PM Peak Hour																Grand Total
		Northbound				Southbound				Eastbound				Westbound				
		Left	Thru	Right	Total	Left	Thru	Right	Total	Left	Thru	Right	Total	Left	Thru	Right	Total	
Arastradero Rd-Charleston Rd	El Camino Real	93	-2	48	139	95	371	210	676	96	745	116	957	263	1637	90	1990	3762
Del Medio Avenue	El Camino Real	8	1	19	28	2	0	166	168	202	430	2	634	-20	1794	51	1825	2655
San Antonio Road	El Camino Real	28	120	35	183	260	144	465	869	175	432	33	640	-62	1291	354	1583	3275
Showers Drive	El Camino Real	5	14	25	44	17	-3	187	201	162	159	64	385	-12	1522	220	1730	2360
Ortega Avenue	El Camino Real	6	0	10	16	13	2	24	39	-29	210	7	188	-10	1832	6	1848	2091
Rengstorff Avenue	El Camino Real	10	9	6	25	13	4	684	701	110	370	5	485	-56	968	186	1098	2309
San Antonio Road	California Street	45	114	340	499	409	55	-58	406	-67	166	-3	96	270	161	518	949	1950
Pacchetti Way	California Street	60	-1	45	104	21	16	-51	-14	-1	916	22	937	7	1035	12	1054	2081
Showers Drive	California Street	123	-5	3	121	9	-10	-20	-21	4	1005	25	1034	81	912	39	1032	2166
Ortega Avenue	California Street	44	0	0	44	-5	-1	-2	-8	17	958	-20	955	4	1029	20	1053	2044
Rengstorff Avenue	California Street	151	58	111	2127	-62	211	-64	2617	-40	689	312	-43	307	1034	65	1154	5855
Rengstorff Avenue	Central Expressway	127	119	-98	148	64	247	-13	298	-26	131	2	107	-58	1071	28	1041	1594
San Antonio Road	Middlefield Road	439	43	-142	340	6	47	209	262	282	106	255	643	-161	480	10	329	1574

Note: Difference is calculated as 2020 Volumes (from Table 6A) - Counted Volumes from the City Place Santa Clara EIR (from Table 5A). A negative value indicates the City Place counts are less than recent counts.

Table 6C: Percent Difference between 2020 Volumes and Counted Volumes used in the City Place Santa Clara EIR (Only showing for turn movements greater than 150 vehicles)

North/South	East/West	PM Peak Hour																Grand Total
		Northbound				Southbound				Eastbound				Westbound				
		Left	Thru	Right	Total	Left	Thru	Right	Total	Left	Thru	Right	Total	Left	Thru	Right	Total	
Arastradero Rd-Charleston Rd	El Camino Real	39%	0%	9%	11%	37%	54%	54%	51%	33%	39%	39%	38%	49%	65%	32%	60%	45%
Del Medio Avenue	El Camino Real							64%	54%	64%	21%		27%		61%	28%	57%	45%
San Antonio Road	El Camino Real	14%	15%		16%	42%	19%	74%	43%	29%	27%	14%	26%	-18%	58%	61%	51%	38%
Showers Drive	El Camino Real				23%	6%		52%	30%	34%	10%	39%	17%		57%	50%	54%	37%
Ortega Avenue	El Camino Real								23%		10%		9%		59%		57%	38%
Rengstorff Avenue	El Camino Real					3%		83%	58%	36%	18%		21%		41%	35%	37%	36%
San Antonio Road	California Street		8%	78%	27%	40%	5%	-33%	17%	-42%	61%		21%	78%	69%	47%	56%	30%
Pacchetti Way	California Street	22%			29%					64%	9%		55%		69%		68%	56%
Showers Drive	California Street	43%		1%	21%				-11%		71%		66%	32%	74%		66%	56%
Ortega Avenue	California Street				25%					57%			54%		69%		65%	56%
Rengstorff Avenue	California Street	77%	11%	64%	78%	-37%	30%	-38%	73%	-15%	59%	79%	-5%	88%	77%	33%	71%	67%
Rengstorff Avenue	Central Expressway	53%	16%	-64%	13%	38%	29%		27%		10%	1%	7%	-27%	62%	15%	49%	27%
San Antonio Road	Middlefield Road	65%	4%	-57%	16%	3%	4%	66%	15%	71%	18%	48%	42%	-55%	59%		26%	24%

Note: Percent Difference is calculated as Difference between Cumulative Volumes and Counted Volumes from the San Antonio Precise Plan EIR (from Table 6B) divided by Counted Volume in San Antonio Precise Plan EIR (from Table 5A).

Table: SAPP TIA Trip Generation Comparison

Project	Land Use Amount				Trip Generation			
	Resi. (du)	Retail (ksf)	Office (ksf)	Hotel (rm)	AM In	AM Out	PM In	PM Out
San Antonio Precise Plan Trip Generation (A)	1112	554.074	934.857	167	1232	794	1621	2022
San Antonio Center Phase III (Project) (B)		12.97	169.382		117	20	40	144
San Antonio Village Phase I	330	69			75	160	256	205
San Antonio Village Phase II (as built)		149.668	360.909	167	364	98	256	466
250 San Antonio Circle			3.35		5	1	1	4
2580 California Street	632	-33	-70		-51	233	178	-13
400 San Antonio Road	583	11.171			66	242	255	148
394 Ortega Avenue	143				15	58	58	31
2645-2655 Fayette Drive	38				4	16	15	8
590 Showers Drive		14.3			9	5	25	28
334 San Antonio Road	63	2			8	26	29	18
Approved & Constructed Projects (C)	1789	213.139	294.259	167	495	839	1073	895
Net Difference (A-B-C)	-677	327.965	471.216	0	620	-65	508	983

Appendix F: Background Project Trip Generation

Table F-1: Background Project Trip Generation

ID	City	Address	Description	Project Status	Land Use 1	Land Use 1 Size	Land Use 2	Land Use 2 Size (ksf)	Existing Land Use 1	Existing Land Use 1 Size 1 (ksf)	Existing Land Use 2	Existing Land Use 2 Size 2 (ksf)	Existing AM Trips In	Existing AM Trips Out	Existing PM Trips In	Existing PM Trips Out	Approved AM Trips In	Approved AM Trips Out	Approved PM Trips In	Approved PM Trips Out	Net AM Trips In	Net AM Trips Out	Total Net AM Trips	Net PM Trips In	Net PM Trips Out	Total Net PM Trips
MV53	MV	2300 West El Camino Real	Replace existing 71-room hotel with a new 4-story 75,824 sq. ft. 153-room hotel with an expanded one-level underground parking garage	Approved	Hotel	153			Hotel	71			20	14	22	21	42	29	47	45	23	16	39	25	24	49
MV44	MV	1958 Latham Street	6-unit rowhouse	Approved	Single Family Homes	6							0	0	0	0	1	3	4	2	1	3	4	4	2	6
MV63	MV	2700 West El Camino Real	Replace existing motel and vacant restaurant buildings with 211 apartment units and 2,000 sq. ft. of ground floor commercial space with underground parking	Under construction	Multifamily Housing (Mid-Rise)	211	Retail	2	High-turnover (sit-down) restaurant	9.6	Hotel	98	80	62	88	64	21	57	60	40	-59	-5	-64	-28	-24	-52
MV79	MV	250 San Antonio Circle	Replace existing two auto repair buildings and associated shed to construct a new 3,350 sq. ft. building for the Community School of Music and Arts	Under construction	Junior/Community College	3.35			Automobile Parts and Service Center	8.367			12	4	8	11	5	2	3	3	-7	-3	-9	-4	-8	-13
MV58	MV	2580 and 2590 California Street / 201 San Antonio Circle	Replace existing 70 ksf office building and 53 ksf of retail with 632 new residential units and 20 ksf of commercial space	Under construction	Multifamily Housing (Mid-Rise)	632	Retail	20	Office	70	Retail	53	101	30	110	173	71	176	206	148	-30	145	115	96	-25	72
MV71	MV	315 and 319 Sierra Vista Avenue	15-unit rowhouse	Under construction	Single Family Homes	15							0	0	0	0	3	8	9	5	3	8	11	9	5	15
MV68	MV	1998 - 2024 Montecito Avenue	Replace 3 apartments and a single-family home to construct a new 3-story 17-unit condominium development with underground parking	Under construction	Multifamily Housing (Mid-Rise)	17			Single Family Homes	1	Multifamily Housing (Low-Rise)	3	1	2	2	1	2	5	5	3	1	3	4	3	2	5
MV73	MV	1950 Montecito Avenue	33-unit rowhouse	Under construction	Single Family Homes	33							0	0	0	0	6	18	21	12	6	18	24	21	12	33
MV62	MV	2044 and 2054 Montecito Avenue	52-unit rowhouse	Under construction	Single Family Homes	52							0	0	0	0	10	29	32	19	10	29	38	32	19	51
MV81	MV	410 - 414 Sierra Vista Avenue	14-unit rowhouse	Under construction	Single Family Homes	14							0	0	0	0	3	8	9	5	3	8	10	9	5	14
MV76	MV	2005 Rock Street	8 rowhouse units and 7 townhome units	Under construction	Single Family Homes	15							0	0	0	0	3	8	9	5	3	8	11	9	5	15
MV77	MV	2310 Rock Street	Replace 59 existing multi-family units with a new 55-unit rowhouse project	Under construction	Single Family Homes	55			Multifamily Housing (Low-Rise)	59			6	21	21	12	10	31	34	20	4	10	14	13	8	21
MV49	MV	1555 West Middlefield Road	Replace existing 116-unit apartment complex to create a new 115-unit rowhouse development	Approved	Single Family Homes	115			Multifamily Housing (Low-Rise)	116			12	41	41	24	21	64	72	42	9	23	32	31	18	49
MV57	MV	828 and 836 Sierra Vista Avenue	Replace 3 existing single-family homes and one duplex with a new 20 rowhome development	Approved	Single Family Homes	20			Single Family Homes	5			1	3	3	2	4	11	12	7	3	8	11	9	5	15
MV43	MV	851 - 853 Sierra Vista Avenue	Replace 3 existing single-family homes and a warehouse building with a new 9-rowhouse development	Approved	Single Family Homes	9			Single Family Homes	3			1	2	2	1	2	5	6	3	1	3	4	4	2	6
MV64	MV	858 Sierra Vista Avenue	Replace an existing single-family home with four new small-lot single-family homes	Under construction	Single Family Homes	4			Single Family Homes	1			0	1	1	0	1	2	2	1	1	2	2	2	1	3
MV50	MV	2019 Leghorn Street	Replace 5 existing residential units and associated accessory structures with a new two-story 12,050 sq. ft. office building	Approved	Office	12.05			Single Family Homes	5			1	3	3	2	12	2	2	12	11	-1	10	-1	10	9
PA	PA	4256 El Camino Real	Replace an existing 3,300 sq. ft. commercial building with a new five-story approximately 51,300 sq. ft. 96-room hotel.		Hotel	96			Retail	3.3			2	1	6	7	27	18	29	28	25	17	42	23	22	45
PA	PA	3406 Hillview Avenue	Demolition of existing 62,500 sf R&D Building and construction of a new 82,030 Office and R&D Building		Research and Development Center		62.5		Research and Development Center	82.03			26	9	6	34	0	0	0	0	-26	-9	-34	-6	-34	-40
PA	PA	3215 Porter Drive	20,833 sq. ft. two-story office building with below grade parking		Office	20.833							0	0	0	0	21	3	4	20	21	3	24	4	20	24
PA	PA	788 San Antonio Avenue	Demolition of two existing on-site one-story commercial structures and construction of a four-story mixed-use structure with 102 dwelling units and 1,803 of retail space.		Multifamily Housing (Mid-Rise)	102	Retail	1.803	General Light Industrial	22.718			14	2	2	12	11	28	31	21	-3	26	23	29	9	37
PA	PA	1451 - 1601 California Avenue	New 180-unit housing development		Single Family Homes	68			Multifamily Housing (Mid-Rise)	112			10	30	30	19	13	38	42	25	2	8	10	12	6	18
PA	PA	380 Cambridge Avenue	New three-story 35,000 sq. ft. commercial building		Retail	35							0	0	0	0	20	13	64	69	20	13	33	64	69	133
PA	PA	180 El Camino Real	Demolition of existing 76,300 sq. ft. Macy's Men's retail and existing parking replaced by 78,500 sq. ft. of new retail and approximately 28,714 sq. ft. of other new retail.		Retail	107.214			Retail	76.3			44	27	140	151	62	38	196	212	18	11	29	57	61	118
PA	PA	620 Emerson St	New 2,756 sq. ft. restaurant		High-turnover (sit-down) restaurant	2.756							0	0	0	0	15	12	17	10	15	12	27	17	10	27
LA	LA	962 Acacia Avenue	3-story mixed use building with 600 sq. ft. of commercial space and 2 condominium units	Approved	Multifamily Housing (Mid-Rise)	2	Retail	0.6					0	0	0	0	1	1	2	2	1	1	1	2	2	3
LA	LA	4856 El Camino Real	Replace two commercial buildings with a new five-story 52-unit multiple family building	Approved	Multifamily Housing (Mid-Rise)	52							0	0	0	0	5	14	14	9	5	14	19	14	9	23
LA	LA	425 First Street	Replace existing 4,500 sq. ft. two-story office building with a new three-story 20-unit multiple-family building	Approved	Multifamily Housing (Mid-Rise)	20			Office	4.5			4	1	1	4	2	5	5	3	-3	5	2	5	-1	4
LA	LA	5150 El Camino Real	Replace existing 78,950 sq. ft. three-story office building with a new 196-unit multiple-family development (24 three-story townhouse units and 172 condominium units)	Approved	Multifamily Housing (Mid-Rise)	196			Office	78.95			79	13	15	76	18	52	53	34	-60	39	-21	38	-43	-5
LA	LA	4898 El Camino Real	Replace existing two-story commercial building with a new five-story 21-unit (or 28 unit) multiple-family building (indicated as to be selected in 2019)	Approved	Multifamily Housing (Mid-Rise)	28							0	0	0	0	3	7	8	5	3	7	10	8	5	12
LA	LA	444-450 First Street	Replace existing 10,000 sq. ft. office building with new 4-story 27-unit multiple-family building	Approved	Multifamily Housing (Mid-Rise)	27			Office	10			10	2	2	10	3	7	7	5	-7	6	-2	5	-5	0
LA	LA	385, 387, & 389 First Street	Replace existing one-story commercial building (approximately 3,160 sq. ft.) with a new three-story mixed use building with 2,800 sq. ft. of office space and 10 condominium units	Under construction	Multifamily Housing (Mid-Rise)	10	Office	2.8	Retail	3.16			2	1	6	6	4	3	3	4	2	2	4	-3	-2	-4
LA	LA	4880 El Camino Real	New five-story 21-unit multiple-family building	Under construction	Multifamily Housing (Mid-Rise)	21							0	0	0	0	2	6	6	4	2	6	8	6	4	9
LA	LA	97 Hillview Avenue (New Community Center)	24,500 sq. ft. of community center space including a community room, multipurpose rooms, meeting rooms, catering kitchen, and dedicated spaces for seniors, teens, and the City-run preschool program.	Under construction	Recreational Community Center	24.5							0	0	0	0	28	15	27	30	28	15	43	27	30	57
LA	LA	517 Tyndall Street	New two-story multiple-family building with three residential townhouse condominium units	Under construction	Multifamily Housing (Low-Rise)	3							0	0	0	0	0	1	1	1	0	1	1	1	1	2
LA	LA	170 State Street	Interior renovation of an existing two-story mixed-use building for a new restaurant food court and office space. Building is currently vacant.	Under construction	High-turnover (sit-down) restaurant	16.505	Office	16.495					0	0	0	0	107	77	103	77	107	77	183	103	77	180

[this page left blank intentionally]

Appendix E
Utility Impact Study

San Antonio Center – Phase III Utility Impact Study

Prepared for
ICF

and

City of Mountain View
500 Castro Street
Mountain View, CA 94041



A handwritten signature in blue ink, appearing to read "LM Coponen", is written over a horizontal line.

Leif M Coponen, California RCE No. 70139



July 23, 2021

Schaaf & Wheeler
CONSULTING CIVIL ENGINEERS

1171 Homestead Road, Suite 255
Santa Clara, CA 95050
(408) 246-4848
FAX (408) 246-5624
fsalamanca@swhsv.com

Table of Contents

Executive Summary	1
Chapter 1. Introduction	1-1
1.1. Project Description	1-1
1.2. Water System Analysis Approach	1-1
1.3. Sewer System Analysis Approach	1-2
1.4. Storm Drain System Analysis Approach	1-3
1.5. Report Organization	1-3
Chapter 2. Water Demand Projections	2-1
2.1. Project Water Demand	2-1
2.1.1. Project Fire Flow Requirement	2-1
2.2. Existing Condition (2010)	2-2
2.2.1. Pre-Project (Baseline) Land Use and Demand	2-2
2.2.2. Post-Project Incremental Demand	2-2
2.3. Future Cumulative Condition (2030)	2-3
2.3.1. Pre-Project (Baseline) Land Use and Demand	2-3
2.3.2. Post-Project Land Use and Demand	2-3
Chapter 3. Water System Impact	3-1
3.1. Demand Scenarios and Performance Criteria	3-1
3.2. Water Supply Analysis	3-1
3.3. Water Storage Analysis	3-2
3.4. Existing Condition (2010) Results	3-2
3.4.1. Hydraulic Model Information	3-2
3.4.2. Peak Hour Demand (PHD) – Pre and Post Project	3-3
3.4.3. Maximum Day Demand with Fire Flow (MDD+FF) – Pre and Post Project	3-3
3.4.4. Deficiencies – Pre and Post Project	3-3
3.5. Future Cumulative Condition (2030) Results	3-4
3.5.1. Hydraulic Model Information	3-4
3.5.2. Peak Hour Demand (PHD) – Pre and Post Project	3-4
3.5.3. Maximum Day Demand with Fire Flow (MDD+FF) – Pre and Post Project	3-4
3.5.4. Deficiencies – Pre and Post Project	3-4
Chapter 4. Sewer Flow Projections	4-1
4.1. Project Sewer Flow	4-1
4.2. Existing Condition (2010)	4-1
4.2.1. Pre-Project (Baseline)	4-1
4.2.2. Post-Project	4-2
4.3. Future Cumulative Condition (2030)	4-2
4.3.1. Pre-Project (Baseline)	4-2
4.3.2. Post-Project (Baseline)	4-3
Chapter 5. Sewer System Impact	5-1
5.1. Scenarios and Performance Criteria	5-1
5.2. Sewer Treatment, Joint Interceptor, and San Antonio Interceptor Capacity	5-1
5.3. Existing Condition (2010) Results	5-2

5.3.1.	Hydraulic Model Information.....	5-2
5.3.2.	Peak Wet Weather Flow (PWWF) Scenario – Pre and Post Project.....	5-3
5.3.3.	Deficiencies – Pre and Post Project.....	5-3
5.4.	Future Cumulative Condition (2030) Results.....	5-3
5.4.1.	Hydraulic Model Information.....	5-3
5.4.2.	Peak Wet Weather Flow (PWWF) Scenario – Pre and Post Project.....	5-3
5.4.3.	Deficiencies – Pre and Post Project.....	5-3
5.4.4.	Alma Recorder Contractual Limit.....	5-4
Chapter 6.	Storm System Impact.....	6-1
6.1.	Impervious Area Change and Hydrologic/Hydraulic Change.....	6-1
6.2.	Project Contribution to Existing Deficiencies.....	6-1

List of Figures

Figure 1R: Water Model Simulations

Figure 2R: Sewer Model Simulations

Figure 1: Project Location

Figure 2: Peak Hour Demand (PHD) – Without Project – Existing Condition

Figure 3: Peak Hour Demand (PHD) – With Project – Existing Condition

Figure 4: MDD with Fire Flow (MDD + FF) – Without Project – Existing Condition

Figure 5: MDD with Fire Flow (MDD + FF) – With Project – Existing Condition

Figure 6: Peak Hour Demand (PHD) – Without Project – Future Cumulative Condition

Figure 7: Peak Hour Demand (PHD) – With Project – Future Cumulative Condition

Figure 8: MDD with Fire Flow (MDD + FF) – Without Project – Future Cumulative Condition

Figure 9: MDD with Fire Flow (MDD + FF) – With Project – Future Cumulative Condition

Figure 10: Peak Wet Weather Flow (PWWF) – Without Project – Existing Condition

Figure 11: Peak Wet Weather Flow (PWWF) – With Project – Existing Condition

Figure 12: Peak Wet Weather Flow (PWWF) – Without Project – Future Cumulative Condition

Figure 13: Peak Wet Weather Flow (PWWF) – With Project – Future Cumulative Condition

Figure 14: Storm Drain System – 10 Year Results

List of Tables

Table 2-1: Project Water Demand..... 2-1

Table 2-2: Anticipated Project Fire Flow Requirement..... 2-2

Table 2-3: Baseline Demand for Existing Condition (Based on Model)..... 2-2

Table 2-4: Incremental Project Demand for Existing Condition..... 2-2

Table 2-5: Baseline Demand for Future Cumulative Condition (Based on Model).....	2-3
Table 2-6: Incremental Project Demand for Future Cumulative Condition.....	2-3
Table 3-1: Peaking Factors	3-1
Table 3-2: Water System Performance Criteria	3-1
Table 3-3: Future Cumulative Condition Demand versus Supply	3-2
Table 3-4: DDW Storage Requirements	3-2
Table 3-5: Existing Condition Evaluated Project Fire Flow Nodes	3-3
Table 3-6: Existing Condition Fire Flow Deficient Nodes Pre- and Post-Project	3-3
Table 3-7: Future Cumulative Condition Evaluated Project Fire Flow Nodes.....	3-4
Table 3-8: Selected Future Cumulative Condition Fire Flow Deficient Nodes Pre- and Post-Project.....	3-5
Table 4-1: Project Sewer Flow.....	4-1
Table 4-2: Baseline Flow for Existing Condition (Based on Model)	4-2
Table 4-3: Incremental Project Flow for Existing Condition.....	4-2
Table 4-4: Baseline Flow for Future Cumulative Condition (Based on Model).....	4-3
Table 4-5: Incremental Project Flow for Future Cumulative Condition	4-3
Table 5-1: Sewer System Performance Criteria	5-1
Table 5-2: RWQCP Join Facilities Capacity Rights	5-2
Table 5-3: Capacity Rights Comparison.....	5-2
Table 5-4: Existing Condition Model Results – Pre and Post Project	5-5
Table 5-5: Future Cumulative Condition Model Results – Pre and Post Project.....	5-6
Table 5-6: Pipes Recommended for Upsizing and Percentage of Flow Contribution	5-7
Table A-1: Additional Considered Projects for Future Cumulative Condition	A-1

Executive Summary

Schaaf & Wheeler has been retained by ICF to determine impacts from the San Antonio Center – Phase III Development (Project) on the City of Mountain View's (City) water, sanitary sewer, and storm drainage systems. The Project site is located within the San Antonio Precise Plan at the south east corner of the intersection of San Antonio Road and California Street (Figure 1). The Project proposes to build a single seven story mixed-use building with four levels of underground parking, up to 15,000 square feet of retail, and 167,352 square feet of commercial and office space. The Project will demolish two existing single-story buildings on-site currently utilized as office and retail.

The Project site is located within the P-(40) San Antonio Precise Plan (adopted December 2014) encompassing the San Antonio Change Area identified in the 2030 General Plan Update at the northeast intersection of San Antonio Road and California Street (Figure 1). The Project is also within the City's Sanitary Sewer system Alma Recorder Tributary Area; flow from this area is contractually limited to two million gallons per day of peak wet weather flow (PWWF). The San Antonio Change Area Subsequent Environmental Impact Report (SEIR) analyzed the change in allowable development beyond what was analyzed in the 2030 General Plan Environmental Impact Report. The analysis herein is evaluating the incremental increase in development levels above the San Antonio Change Area. This Project proposes an amendment to remove the 400,000 gsf limit of net new office space within the Northwest San Antonio Master Plan and to facilitate a transfer of 150,000 gsf from the Los Altos School District.

Project impacts are analyzed for both Existing (2010) and Future Cumulative (2030) Condition for the sewer and water system. Hydraulic models simulating pre- and post-Project development scenarios are performed to examine hydraulic deficiencies. The Existing Condition water model is based on the *2010 Water Master Plan (WMP)* and the Future Cumulative Condition is created from the *2030 General Plan – Updated Water System Modeling (GP-UWSM; Schaaf & Wheeler, June 2014)* model. Both the Existing Condition model and the Future Condition model include the land use and corresponding water demands from the San Antonio Change Area SEIR. The Future Cumulative Condition model also includes City approved projects since the 2030 General Plan Update UIS (GPUUIS) was adopted. The Existing Condition and Future Cumulative Condition sewer models are based on the model developed as part of the *Wastewater Capacity and Alignment Study El Camino Real & San Antonio Change Areas Project 14-48 (West Yost, 2017)* model. The Future Cumulative Condition sewer model includes recommended improvement projects from the West Yost (2017) report but does not include Capital Improvement Projects (CIPs) in the 2010 SMP or 2030 GPUUIS.

Impacts to the storm drain system resulting from Project development are evaluated with the *2017 Storm Drain Master Plan (2017 SDMP)* developed model. The proposed Project land use is compared with pre-Project land use to determine changes in the drainage pattern resulting from Project development.

Water System Project Impacts

The Project development does not significantly impact the water system at Existing Condition or during Future Cumulative Condition assuming all the recommended CIPs in the GP-UWSM have been constructed. The Project

specific fire flow requirement is anticipated to be 1,750 gpm based on building square footage, construction type, and a 50% reduction to be approved by the City Fire Marshal based on the installation of an approved fire sprinkler system. This is a conservative reduction assumption, as buildings have the potential for a 75% reduction of the required fire flow according to the California Fire Code (2019), if approved. The required fire flow is met during Existing Condition and Future Cumulative Condition. The actual fire flow requirement may change as the planning process continues and Project specific requirements are determined by the City Fire Marshal. If Project conditions require higher fire flow than what is analyzed, revised modeling should be conducted.

Sewer System Project Impacts

In the Existing Condition pipes downstream of the Project are surcharging during PWWF according to model results. The Project adds flow to the existing deficiencies, but does not increase the number of deficient pipes.

In the Future Cumulative Condition, the sewer system does not have adequate capacity pre- or post-Project with the CIPs recommended in the *Wastewater Capacity and Alignment Study El Camino Real & San Antonio Change Areas Project 14-48* (West Yost, 2017). In the report, the capacity of the sewer system within the Alma Recorder tributary area was evaluated and new infrastructure was recommended. The new infrastructure was recommended to divert flow from surcharged pipes along Songroth Way. Schaaf & Wheeler recommends that several pipes in the West Yost CIPs are upsized from 10-inch and 12-inch diameter to 15-inch diameter to meet the City's d/D criteria. With these pipes upsized, all pipes meet the d/D criteria in both pre- and post-Project conditions. The Project contribution to the recommended CIPs is determined and may be used to estimate developer impact fees for fair share impact to the system.

The Project is located within the portion of the City referred to as the Alma Recorder Area that contributes flow to the Los Altos Inceptor Sewer and has a contractual limitation of two million gallons per day of PWWF. In the Existing Condition, pre-Project flow to the Alma Recorder during PWWF is 14% below the contractual limit and 13% below the contractual limit post-Project. In the Future Cumulative Condition, pre-Project flow to the Alma Recorder during PWWF is 8% below the contractual limit pre- and post-Project.

Storm System Project Impacts

The proposed Project development does not significantly impact downstream storm drain pipes. An increase in peak runoff with Project development is expected based on the increased impervious land use area compared to the existing site. However, the Project is not anticipated to result in any additional deficiencies because the post-Project peak flow is only 3% higher than pre-Project peak. Model results show that the hydraulic grade at the connection to the existing 30-inch storm main in California Street increases by 0.01 foot and does not result in additional deficiencies downstream.

The SDMP identifies some flooding downstream of the Project, and recommends one CIP between San Antonio Road and Adobe Creek. This CIP upsizes a 6.5-foot diameter storm drain pipe to 8-foot diameter storm drain pipe to alleviate flooding during the 10-year event when Adobe Creek levels are high. The increase in runoff does increase the modeled surcharge depth at existing locations with surcharging.

Chapter 1. Introduction

1.1. Project Description

The San Antonio Center – Phase III Project (Project) proposes the construction of a mixed-use development and the demolition of existing buildings based on the Project Plan Set dated January 5, 2021, and Project Description provided March 11, 2021. The Project includes a constructing a new 7-story building, with four levels of underground parking on a 0.99 acre site. The building will provide up to 15,000 square feet of retail and 167,352 square feet of commercial/office. The new building will be dual-plumbed for future recycled water use if/when it is available in the future. The Project will demolish 2 existing buildings within the San Antonio Precise Plan Area (adopted December 2014), which provides detailed development standards set forth in the 2030 General Plan Update.

The Project also proposes an amendment to remove the 400,000 gsf limit of new office space within the Northwest San Antonio Change Area, while maintaining the total office within the San Antonio Precise Plan at 600,000 gsf of office.

1.2. Water System Analysis Approach

Project impacts are analyzed using the City’s water model for two conditions: Existing (2010) and Future Cumulative (2030). As a baseline for system performance, each condition is evaluated pre-Project for existing hydraulic deficiencies. The estimated incremental water demand resulting from Project development is added to the model and post-Project deficiencies are examined. In total, four model simulations of the water system are performed, as shown in Figure 1.

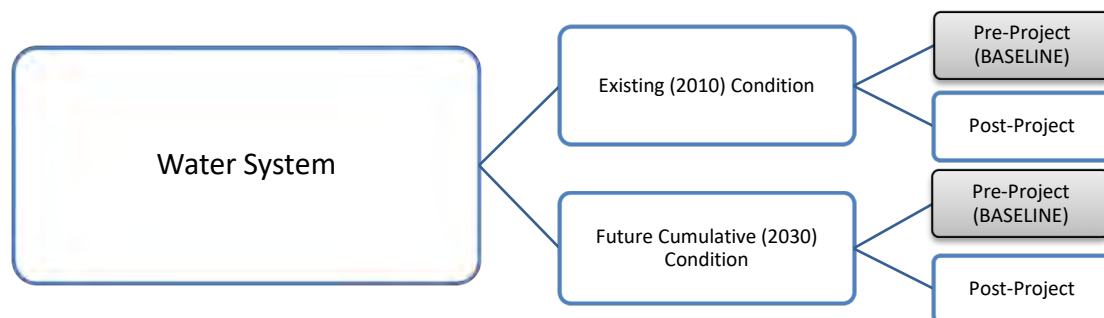

Figure 1R. Water Model Simulations

The Existing Condition model consists of the existing distribution system and operating parameters along with water demands based on existing land use from the *2010 Water Master Plan (WMP)*. The Future Cumulative Condition water demand is based on the 2030 General Plan Update (GPU) land use and has since been revised to include recent City approved projects not accounted for or in exceedance of the 2030 GPU projections. Table A-1 in Appendix A provides a list of the additional considered development projects for the Existing and

Future Cumulative Conditions. The Future Cumulative Condition model includes the operating parameters from the *2030 General Plan Update (GPU) – Updated Water System Modeling (GP-USWM; Schaaf & Wheeler, June 2014)* model and assumes all of the recommended CIPs in the GP-UWSM have been constructed.

1.3. Sewer System Analysis Approach

Project impacts to the sewer system are analyzed using the City’s sewer model for two conditions: Existing (2010) and Future Cumulative (2030). As a baseline for system performance, each condition is evaluated pre-Project for existing hydraulic deficiencies. The estimated incremental sewer flow resulting from Project development is added to the model and post-Project deficiencies are examined. In total, four model simulations of the sewer system are performed, as shown in Figure 2.

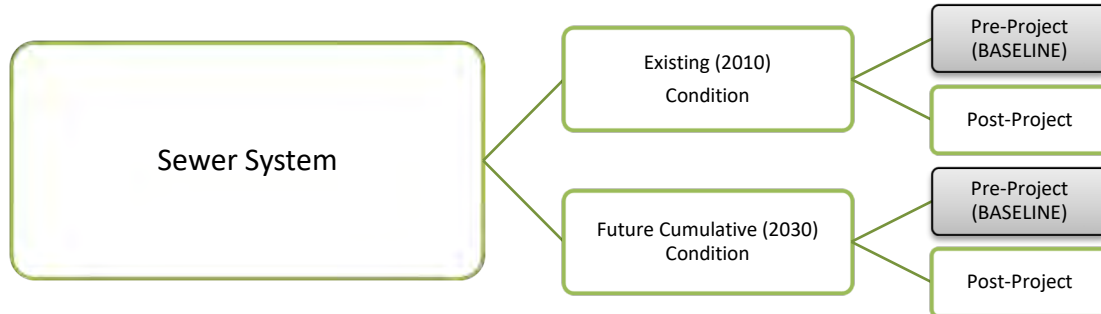

Figure 2R. Sewer Model Simulations

The Existing Condition and Future Cumulative Condition models for the sewer system are based on the model developed as part of *Wastewater Capacity and Alignment Study El Camino Real & San Antonio Change Areas Project 14-48* (West Yost, 2017). This model is used in this analysis because it was developed to model the Alma Recorder tributary area in more detail than previous studies. Both the Existing Condition and Future Cumulative Condition models have been updated to reflect incremental flow increases from recent development along El Camino Real within the Alma Recorder tributary area. Table A-1 in Appendix A provides a list of the additional considered development projects for the Existing and Future Cumulative Conditions. The Future Cumulative Condition model includes incremental increases in flow from the Greystar MVSA Project and assumes the CIPs recommended in the West Yost (2017) report have been constructed per the *Showers Drive Sanitary Sewer Improvement Project 35% Design Submittal* (2017), which includes the relocation of the Alma Recorder further north of Alma Street. The Future Cumulative Condition also assumes a portion of CIP #32 from the GPUUIS is included – as recommended as part of the Greystar MVSA Project.

1.4. Storm Drain System Analysis Approach

The storm drain system is evaluated for anticipated drainage pattern changes at the Project site after development. Pre-Project conditions are assumed to match site conditions modeled as part of the Existing Condition model developed as part of the *City of Mountain View Storm Drain Master Plan* (SDMP; Schaaf & Wheeler, 2019). For the post-Project condition, the catchment covering the Project site is updated with the proposed site characteristics, both in terms of land use changes and piping. Anticipated changes to the drainage patterns with the proposed site characteristics are evaluated and runoff rates after Project development are calculated. The performance of the storm drain infrastructure under both pre-Project and post-Project conditions are analyzed against a 10-year design storm based on the City's design standards.

1.5. Report Organization

This report is organized into five following sections. Chapter 2 discusses the water demand estimates for the Project and Chapter 3 covers the impacts and capital improvement recommendations for the water system. Chapter 4 provides the sewer demand estimates and Chapter 5 presents the sewer system impacts. Chapter 6 discusses the storm drain system impacts.

Chapter 2. Water Demand Projections

This chapter discusses the water demand estimates and required fire flow for the Project development and provides a comparison to pre-Project baseline conditions. The incremental Project demand is determined for both Existing (2010) and Future Cumulative (2030) Condition, as discussed in the following sections. To remain consistent with the City-wide model, this analysis uses the estimated water demand and duty factors at the Project site from the City's hydraulic models.

Water demand in this section represents Average Daily Demand (ADD). Water use patterns vary for different customers and at different times of the day and year. The ADD is an estimated daily average of these variations by land use type.

2.1. Project Water Demand

Parcel-level water demand for the proposed Project is estimated using the maximum square footage of retail and commercial/office identified in the Draft Project Description Provided March 11, 2021. The proposed building will include a maximum of 15,000 square feet of retail and 167,352 square feet of commercial/office space. The water demands are determined by taking the square footage for each type of usage and multiplying by the correct duty factor. The water unit duty factor for retail is taken from Table 2-1 in the 2030 GPUUIS. The water unit duty factor for commercial/office is taken from the NBSPP II Table 2-2, general office is assumed for the duty factor. Table 2-1 details the estimated Project demand.

Table 2-1: Project Water Demand

Usage Type	Square Feet Or Dwelling Units	Duty Factor (gpd/1000 sq ft)	Water Demand (gpd)
Retail	15,000	130	1,950
General Commercial/office*	167,352	90	15,062
Total			17,012

**Assumes general office for the duty factor*

2.1.1. Project Fire Flow Requirement

The anticipated project-specific fire flow requirement at the site is based on the 2019 California Fire Code (CFC) Appendix B, which gives the minimum fire flow requirement based on the fire-flow area and building construction type. Construction type and floor area for the Project is based on the Project Description provided March 11, 2021

Based on the California State Fire Marshal Code Interpretation 11-015 for mixed use construction, the fire flow requirement for the Project is calculated using the largest three floor areas for Construction Type 1-B. The calculated fire flow is 3,500 gpm. A 50 percent reduction of the fire flow rate is used as the project-specific fire flow requirement in this evaluation. This is a conservative reduction estimate as up to a 75 percent reduction is allowed upon approval of an automatic sprinkler system according to CFC Section B105; the resulting fire flow

cannot be less than 1,500 gpm. The actual fire flow requirement may change as the planning process continues and Project-specific requirements are determined by the City Fire Marshal.

Table 2-2 – Anticipated Project Fire Flow Requirement

Construction Type	Fire-Flow Calculation Area (sf)	CFC Required Fire Flow (gpm)	Fire Flow with 50% Reduction (gpm)	Fire Flow with 75% Reduction (gpm)
I-B	109,350	3,500	1,750	1,500

2.2. Existing Condition (2010)

2.2.1. Pre-Project (Baseline) Land Use and Demand

The pre-Project (baseline) condition includes parcel-level demand adopted from the City’s InfoWater model, developed as part of the 2010 WMP. The demand in the model is calibrated against water billings records from 2005 and 2006, as further explained in the 2010 WMP. Table 2-3 details the model demands at the parcels, which were zoned as commercial-retail. Parcel numbers have been revised, the parcel numbers from the GPU and the newly revised parcel numbers are provided on Table 2-3.

Table 2-3: Baseline Demand for Existing Condition (Based on Model)

Address	APN	2010 Master Plan Land Use Designation	Acreage	Existing Condition Water Demand (gpd)
2595 California Street	147-45-021/ 148-22-006	Com-Retail	0.39	413
2595 California Street	147-45-022/ 148-22-007	Com-Retail	0.24	534
365 San Antonio Rd	147-45-013/ 148-22-005	Com-Retail	0.3	97
405 San Antonio	147-45-016/ 148-22-023	Com-Retail	.06	256
Total			0.99	1,300

2.2.2. Post-Project Incremental Demand

For Project impact analysis in the Existing Condition, Project demand is added to the Existing model as an incremental difference from the pre-Project demand, as shown in Table 2-4.

Table 2-4: Incremental Project Demand for Existing Condition

	Existing Condition Demand (gpd)
Pre-Project (Baseline) Demand	1,300
Project Demand	17,012
Incremental Project Demand	+ 15,712

2.3. Future Cumulative Condition (2030)

2.3.1. Pre-Project (Baseline) Land Use and Demand

Future Cumulative (baseline) demand for the Project is adopted from the City’s InfoWater model developed as part of the 2030 GPUUIS. In the 2030 GPUUIS model, water demands are based on the 2030 General Plan Update (GPU) land use; these demands have since been updated to include recent City approved projects which were not accounted for or were in exceedance of the 2030 GPU projections. Table 2-5 presents the parcel level pre-project demand from the model. Whereas the Existing Condition model was populated with demand based on billing records, the Future Cumulative Condition model has a higher projected future demand for both parcels.

Table 2-5: Baseline Demand for Future Cumulative Condition (Based on Model)

Address	APN	Zoning	Acreage	Future Cumulative Condition Water Demand (gpd)
2595 California Street	147-45-021/ 148-22-006	(P)-40 San Antonio Precise Plan	0.39	640
2595 California Street	147-45-022/ 148-22-007		0.24	399
365 San Antonio Rd	147-45-013/ 148-22-005		0.3	371
405 San Antonio	147-45-016/ 148-22-023		.06	524
Total			0.99	1,934

2.3.2. Post-Project Land Use and Demand

The Project demand is added to the Future Cumulative Condition model as an incremental difference from the pre-Project scenarios as shown in Table 2-6.

Table 2-6: Incremental Project Demand for Future Cumulative Condition

	Future Cumulative Condition Demand (gpd)
Pre-Project Demand	1,934
Project Demand	23,706
Incremental Project Demand	21,772

Chapter 3. Water System Impact

Project impacts to water supply, water storage, hydraulic conveyance, and fire flow requirements are evaluated in this chapter to ensure the Project demand can be adequately met. Hydraulic conveyance and available fire flow are assessed for both Existing (2010) and Future Cumulative (2030) Condition. Water supply and water storage are evaluated for the Future Cumulative Condition.

3.1. Demand Scenarios and Performance Criteria

Hydraulic deficiencies within the water system consider two demand scenarios: Peak Hour Demand (PHD) and Maximum Day Demand with Fire Flow (MDD + FF). The MDD and PHD peaking factors from the 2010 Water Mater Plan (WMP) are used for this analysis. As detailed in the 2010 WMP, MDD and PHD peaking factors are developed using SCADA data from peak usage months in 2006 and 2007. The peak hour occurred on the day with the largest daily demand, which was observed to be August 8, 2007. The calculated peaking factors, presented in Table 3-1, are applied to Average Day Demand (ADD).

Table 3-1: Peaking Factors

Category	Peaking Factor
Maximum Day	1.71
Peak Hour	2.79

Established design criteria used to evaluate the Project impact for all scenarios are summarized in Table 3-2.

Table 3-2: Water System Performance Criteria

Criteria	PHD	MDD + FF
Minimum Allowable Pressure (psi)	40	20

3.2. Water Supply Analysis

The water demand from Project development in the Future Cumulative Condition is compared with the City's supply turnouts and well capacities to ensure demand can be met. The Mountain View water system is divided into three pressure zones to maintain reasonable pressures throughout the City's rising topography moving south, further form the Bay. The Project is located in Pressure Zone 2, which is supplied by two San Francisco Public Utilities Commission (SFPUC) turnouts.

Water demand versus supply capacity by Pressure Zone is given in Table 3-3. Total capacity for Pressure Zone 2 includes peak hour turnout capacity from SFPUC Turnouts #7 and #14 and additional supply from Wells #17, #19, #22, and #20. Demand in Pressure Zone 2 can be sufficiently supplied by the turnouts; however, as discussed in the *2030 General Plan Update Utility Impact Study* (IEC, 2011) surplus supply in Pressure Zone 2 will need to be routed to Pressure Zone 1 to make-up the supply deficiency in the lower Zone. The Project demand does not exceed the SAPP demand allocations, therefore it does not impact the City's ability to meet total system demand.

Table 3-3: Future Cumulative Condition Demand Versus Supply

Pressure Zone	2030 Future Cumulative Demand			Total Capacity (mgd) *
	Pre-Project		Post-Project	
	ADD (mgd)	PHD (mgd)	PHD (mgd)	
1	7.98	22.26	22.26	16.56
2	8.41	23.46	23.46	30.53
3	1.62	4.52	4.52	5.10
Total	18.01	50.25	50.25	52.19

* Total Capacity from Table 3-8 in the General Plan Update Utility Impact Study (IEC, 2011)

3.3. Water Storage Analysis

Project impact to water storage volume requirements is evaluated according to the State Water Resources Control Board Division of Drinking Water (DDW). DDW requires storage equal to 8 hours of Maximum Day Demand (MDD) plus fire flow storage in each pressure zone. The required storage versus active storage in the City is detailed in Table 3-4 pre- and post-Project. The maximum active storage in the City is 17 MG. However, the City currently operates with only the operational active storage of 14.3 MG. Since the City has the storage volume available to meet DDW requirements in the Future Cumulative Condition pre- and post-Project, no additional storage improvements are recommended. In the future, when City demand and storage requirements exceed the current operating storage, the City may need to alter reservoir operation schemes.

Table 3-4: DDW Storage Requirements

Pressure Zone	Maximum Active Storage* (MG)	Operational Active Storage (MG)	Fire Flow (MG)	Future Cumulative Condition Demand					
				Pre-Project			Post-Project		
				ADD (mgd)	8 Hours of MDD (MG)	DDW Requirement (MG)	ADD (mgd)	8 Hours of MDD (MG)	DDW Requirement (MG)
1	6.00	5.1	1.2	7.98	4.55	5.25	7.98	4.55	5.25
2	8.00	6.5	1.2	8.41	4.79	6.30	8.41	4.79	6.30
3	3.00	2.7	1.2	1.62	0.92	2.12	1.62	0.92	2.12
Total	17.00	14.3	3.6	18.01	10.27	13.67	18.01	10.27	13.67

* Active Storage from Table 4-2 in the General Plan Update Utility Impact Study (IEC, 2011)

3.4. Existing Condition (2010) Results

3.4.1. Hydraulic Model Information

Existing water system performance is analyzed with the demands and land use type in the City's InfoWater model developed for the City's 2010 WMP. It is assumed domestic and fire services for the Project will connect to the existing 10-inch diameter water main in California Street.

The Existing Condition pre-Project fire flow requirement is taken from the 2010 WMP model. The planning level (non-reduced) fire flow requirement for the pre-Project land use classification of (P)-40 San Antonio Precise Plan

is 3,500 gpm. After Project development, the Project specific required fire flow at the site is anticipated to be 1,750 gpm with an applied 50% reduction for the assumed approval of an approved automatic sprinkler system.

3.4.2. Peak Hour Demand (PHD) – Pre and Post Project

At Existing Condition, the system meets performance criteria system-wide pre-Project. The Project development does not impact system hydraulic performance under PHD.

3.4.3. Maximum Day Demand with Fire Flow (MDD+FF) – Pre and Post Project

The pre-Project fire flow is set to 5,000 gpm based on parcel specific fire flows identified in the 2010 WMP. This fire flow is not met at the existing hydrant location on California Street and San Antonio Road (Model Node ID J-246). After Project development, the anticipated Project-specific fire flow requirement of 1,750 gpm can be met at the evaluated locations as detailed in Table 3-5. The node is still shown as deficient in the attached figures due to adjacent parcel specific fire demands still being 5,000 gpm.

Table 3-5: Existing Condition Evaluated Project Fire Flow Nodes

Node ID	Location	Required Fire Flow Rate (gpm)	Available Flow Pre-Project (gpm)	Available Flow Post-Project (gpm)
J-246	Project Location – California Street	Pre-Project: 5,000*	4,340	4,316
		Post-Project: 1,750		

*Fire flow of 5,000 gpm from adjacent parcels

3.4.4. Deficiencies – Pre and Post Project

With Existing Condition demands, the water system meets system design criteria under PHD and is able to adequately supply the increased Project demand. Available fire flow pre- and post-Project at selected deficient nodes is presented in Table 3-6. These deficiencies are independent of the Project and show minimal (<1%) impact with Project development.

Table 3-6: Selected Existing Condition Fire Flow Deficient Nodes Pre- and Post-Project

Node ID	Location	Required Fire Flow Rate (gpm)	Available Flow Pre-Project (gpm)	Available Flow Post-Project (gpm)
J-317	San Antonio Rd and El Camino Real	3,500	3,437	3,420
J-279	2630 California Street	5,000	3,597	3,579
J-259	San Antonio Rd and California St	5,000	4,412	4,386
J-225	Pachetti Way and California St	5,000	4,421	4,398
J-229	San Antonio Rd and Miller Ave	5,000	4,464	4,439
J-254	Miller Ave	5,000	4,025	4,004
J-195	462 San Antonio Rd	5,000	4,369	4,344

3.5. Future Cumulative Condition (2030) Results

3.5.1. Hydraulic Model Information

The Future Cumulative Condition model is created using water demand based on the 2030 General Plan Update (GPU) land use and includes the additional projects which were not accounted for or were in exceedance of the 2030 GPU projections. System performance is analyzed under the assumption that all recommended CIPs in the *2030 General Plan – Updated Water System Modeling (GP-UWSM; Schaaf & Wheeler, June 2014)* have been constructed.

Domestic and fire services for the Project are assumed to connect to the existing 10-inch diameter water main in California Street. The Future Cumulative Condition pre-Project fire flow requirement is set to 5,000 gpm based on planning level fire demands for General Commercial Mixed-Use. The planning level flow requirement is met under pre-Project conditions. After Project development, the Project specific required fire flow at the site is anticipated to be 1,750 gpm with an applied 50% reduction for the assumed approval of an approved automatic sprinkler system. The Project specific fire flow requirement can be met under post-Project conditions.

3.5.2. Peak Hour Demand (PHD) – Pre and Post Project

In the Future Cumulative Condition, the system meets performance criteria system-wide Pre-Project. The Project development does not impact system hydraulic performance under PHD.

3.5.3. Maximum Day Demand with Fire Flow (MDD+FF) – Pre and Post Project

The pre-Project fire flow of 1,750 gpm is met at existing hydrant location on California Street and San Antonio Road (Model Node ID J-246). The node is shown as deficient due to high planning level fire flow requirement for adjacent parcels. After Project development, the anticipated Project-specific fire flow requirement of 1,750 gpm can be met at the evaluated locations as detailed in Table 3-7.

Table 3-7: Future Cumulative Condition Evaluated Project Fire Flow Nodes

Node ID	Location	Required Fire Flow Rate (gpm)	Available Flow Pre-Project (gpm)	Available Flow Post-Project (gpm)
J-246	Project Location – California Street	Pre-Project: 5,000* Post-Project: 1,750	5,106	5,083

*Fire flow of 5,000 gpm from adjacent parcels

3.5.4. Deficiencies – Pre and Post Project

With the Future Cumulative Condition demand, the water system meets system design criteria at PHD and is able to adequately supply the increased Project demand. Available fire flow pre- and post-Project at selected deficient nodes is presented in Table 3-8. These deficiencies are independent of the Project development. Several CIPs from the GPU are in the vicinity of the Project and provide additional conveyance to the system, including CIP #31 on Miller Avenue and CIP #32 on California Street which include upsizing 405 LF of 10-inch diameter pipe to 12-inch diameter pipe, and upsizing 375 LF of 8-inch diameter pipe to 12-inch diameter pipe respectively.

Table 3-8: Selected Future Cumulative Condition Fire Flow Deficient Nodes Pre- and Post-Project

Node ID	Location	Required Fire Flow Rate (gpm)	Available Flow Pre-Project (gpm)	Available Flow Post-Project (gpm)
J-279	2630 California Street	5,000	4,991	4,968
J-254	Miller Ave	5,000	4,929	4,906

Chapter 4. Sewer Flow Projections

This chapter discusses the sewer flow estimate for Project development and provides a comparison to pre-Project baseline condition and post-Project conditions in sewer flow generation. The incremental Project flow is determined for both Existing (2010) and Future Cumulative Condition, as discussed in the following sections. The sewer generation factor for estimating Project sewer flow is taken from previous technical studies (2010 WMP, 2030 GPUUIS, and NBPPII) to remain consistent with the City-wide flow projections used in the hydraulic models.

Three types of sewer flow loading are used to model the sewer system: base wastewater flow, groundwater infiltration (GWI), and rainfall-dependent infiltration/inflow (RDI/I). GWI includes base infiltration (BI) and pumped groundwater discharged to the sewer system. RDI/I is stormwater that enters the sewer system. GWI and RDI/I values are modeled as constant flows.

Base wastewater flow (BWF) is from residential, commercial, institutional, office, and industrial sources. As described in the 2010 Sewer Master Plan (SMP), BWF is developed on an individual parcel level using the 2005 and 2006 water billing records and applying a return-to-sewer (RTS) ratio calculated for land use type. Change in BWF throughout the day due to daily use patterns is known as diurnal variation and is accounted for by applying residential and non-residential diurnal curves. BWF and diurnal curves used in this analysis are taken from the 2010 SMP to remain consistent with previous City-wide modeling. The sewer flows discussed in this section are the BWF values representing average flows and are not peaked.

4.1. Project Sewer Flow

Project generated sewer flow is estimated from the square footage provided in the Project Description provided on March 11, 2021, as shown in Table 4-1. A return-to-sewer (RTS) ratio of 0.75 is applied to the retail and commercial/office water duty factor in Table 2-1 based on the 2010 Sewer Master Plan (SMP) RTS ratio. Project sewer flow is assumed to discharge to the 8-inch public main in California Street.

Table 4-1: Project Sewer Flow

Usage Type	Square Feet Or Dwelling Units	Sewer Duty Factor (gpd/1000 sq ft)	Sewer Flow (gpd)
Retail	15,000	100	1,600
General Commercial/office	167,352	70	11,715
Total			13,215

**Assumes general office for the duty factor*

4.2. Existing Condition (2010)

4.2.1. Pre-Project (Baseline)

The pre-Project (baseline) condition includes parcel-level sewer flow developed as part of *Wastewater Capacity and Alignment Study El Camino Real & San Antonio Change Areas Project 14-48* (West Yost, 2017). Table 4-2 presents the Existing Condition pre-Project sewer flows.

Table 4-2: Baseline Flow for Existing Condition (Based on Model)

Address	APN	Zoning	Acreage	Existing Condition Water Demand (gpd)
2595 California Street	147-45-021/ 148-22-006	(P)-40 San Antonio Precise Plan	0.39	413
2595 California Street	147-45-022/ 148-22-007		0.24	534
365 San Antonio Rd	147-45-013/ 148-22-005		0.3	36
405 San Antonio	147-45-016/ 148-22-023		.06	256
Total			0.99	1,239

4.2.2. Post-Project

For the Project impact analysis in the Existing Condition, Project sewer flow is added to the Existing Condition model as an incremental difference from Pre-Project demand. The Project incremental sewer flow is given in Table 4-3.

Table 4-3: Incremental Project Flow for Existing Condition

	Sewer Flow (gpd)
Pre-Project Flow	1,239
Project Flow	13,215
Incremental Project Flow	+11,976

4.3. Future Cumulative Condition (2030)

4.3.1. Pre-Project (Baseline)

The pre-Project (baseline) condition includes parcel-level sewer flow developed as part of *Wastewater Capacity and Alignment Study El Camino Real & San Antonio Change Areas Project 14-48* (West Yost, 2017). Table 4-4 presents the Future Cumulative Condition pre-Project sewer flows.

Table 4-4: Baseline Flow for Future Cumulative Condition (Based on Model)

Address	APN	Zoning	Acreage	Future Cumulative Condition Water Demand (gpd)
2595 California Street	147-45-021/ 148-22-006	(P)-40 San Antonio Precise Plan	0.39	447
2595 California Street	147-45-022/ 148-22-007		0.24	279
365 San Antonio Rd	147-45-013/ 148-22-005		0.3	260
405 San Antonio	147-45-016/ 148-22-023		.06	367
Total			0.99	1,354

4.3.2. Post-Project (Baseline)

For the Project impact analysis in the Future Cumulative Condition, Project sewer flow is added to the Future Cumulative Condition model as an incremental difference from Pre-Project demand. The Project incremental sewer flow is given in Table 4-5.

Table 4-5: Incremental Project Flow for Future Cumulative Condition

	Sewer Flow (gpd)
Pre-Project Flow	1,354
Project Flow	13,215
Incremental Project Flow	+11,861

Chapter 5. Sewer System Impact

The impact of Project development on the sewer system is analyzed under both Existing (2010) and Future Cumulative (2030) Conditions. The specific affected area of the sewer system begins at the Project site and continues east along California Street, north along Pachetti Way, west at the intersection of Pachetti Way and Sondgroth Way toward San Antonio Rd, north along San Antonio Rd, ultimately flowing to the Alma Recorder.

5.1. Scenarios and Performance Criteria

Sewer capacity is analyzed under Peak Wet Weather Flow (PWWF) and Average Dry Weather Flow (ADWF). PWWF is used to determine hydraulic deficiencies according to the performance criteria in Table 5-1. ADWF is used to determine adequacy of treatment capacity.

The ADWF scenario is developed in the model by adding BWF and GWI. Since the ADWF scenario models average daily flows, BWF and GWI are not peaked. The PWWF scenario applies the diurnal peaking curves for residential and non-residential flows and simulates system response to rainfall dependent inflow and infiltration. The diurnal peaking curves are adopted from the City's 2010 SMP. Groundwater Infiltration (GWI) and rainfall-dependent infiltration/inflow (RDI/I) are included, but are not peaked.

Table 5-1: Sewer System Performance Criteria

Criteria	Pipe Diameter ≤ 12 inch	Pipe Diameter > 12 inch
Maximum Flow Depth/Pipe Diameter (d/D)	0.50	0.75

5.2. Sewer Treatment, Joint Interceptor, and San Antonio Interceptor Capacity

Sewage generated within the City is treated at the Regional Water Quality Control Plant (RWQCP) in Palo Alto. The sewer collection system is a gravity system with the majority of flow discharging into three main trunk lines that convey flow from the south to the north and terminate at the Shoreline Pump Station (SPS) located within the City's Shoreline Park. Flow is then pumped to the gravity Joint Interceptor Sewer that conveys flow to the RWQCP. The remaining flow not received at the SPS is discharged to the Los Altos' San Antonio Interceptor that also conveys flow into the Joint Interceptor.

The City entered into a joint agreement, referred to as the Basic Agreement, with the cities of Palo Alto and Los Altos in 1968 for the construction and maintenance of the joint sewer system addressing the need for conveyance, treatment, and disposal of wastewater to meet Regional Board requirements. In accordance with the Basic Agreement, Palo Alto owns the RWQCP and administers the Basic Agreement with the partnering agencies purchasing individual capacity rights in terms of an average annual flow that can be discharged to the RWQCP. Capacity rights of the three cities can be rented or purchased from other neighboring agencies and each partnering agency can sell their capacity to others. Contractual capacity is based upon the 1985 Addendum No. 3 of the 1968 Joint Sewer System agreement that revised capacity rates in relationship to facility expansion and is based upon Average Annual Flow (defined as 1.05 times Average Dry Weather Flow). Separate service agreements with the RWQCP have since reallocated current capacity rights to include six partnering agencies. Table 5-2 presents the current capacity rights for each agency.

Table 5-2: RWQCP Joint Facilities Capacity Rights

Partner Agency	Treatment Capacity	72-inch Joint Interceptor Capacity
	Average Annual Flow (MGD)	Peak Wet Weather Flow (MGD)
Palo Alto	15.3	14.59
East Palo Alto Sanitary District	3.06	0
Los Altos Hills	0.63	3.41
Stanford University	2.11	0
Mountain View	15.1	50
Los Altos	3.8	12
Total	40	80

Source: Long Range Facilities Plan for the Regional Water Quality Control Plant (Carollo, May 2012)

The City's total capacity rights include flow leaving the City through the SPS and the amount of flow that the City discharges into the Los Altos' San Antonio Interceptor, per the 1970 Los Altos San Antonio Trunk Sewer Capacity Agreement between the two cities. The total system-wide contractual capacity for Mountain View is evaluated in the Existing and Future Cumulative Conditions with increased Project flow. Table 5-3 shows the City's projected flows compared to the RWQCP Joint Facilities capacity rights.

Per the Basic Agreement, the partnering agencies agree to conduct an engineering study when their respective service area reaches 80% of their contractual capacity rights. The Future Cumulative Condition estimates that the projected demand pre-Project and post-Project will exceed the 80% capacity threshold. The required engineering study when the City reaches 80% of their capacity shall redefine the anticipated future needs of the treatment plant.

Table 5-3: Capacity Rights Comparison

RWQCP Joint Facility	Mountain View Contractual Capacity (MGD)	Pre-Project		Post-Project	
		2010 Existing (MGD)	2030 Future Cumulative (MGD)	2010 Existing (MGD)	2030 Future Cumulative (MGD)
Treatment	15.1	10.51	14.15	10.53	14.15
Joint Interceptor	50.0	17.3	21.91	17.34	21.91

* Treatment = Average Annual Flow (AAF), Joint Interceptor = PWWF

5.3. Existing Condition (2010) Results

5.3.1. Hydraulic Model Information

The Existing Condition sewer system is modeled using the *Wastewater Capacity and Alignment Study El Camino Real & San Antonio Change Areas Project 14-48* (West Yost, 2017). Project sewer flow is assumed to discharge into the 8-inch diameter public sewer main in California Street

5.3.2. Peak Wet Weather Flow (PWWF) Scenario – Pre and Post Project

The sewer system does not have sufficient capacity downstream of the Project with the pre-Project or post-Project flows in the Existing Condition, as shown in Figure 10.

5.3.3. Deficiencies – Pre and Post Project

Existing Condition model results comparing pre- and post-Project d/D are presented in Table 5-4. In pre-Project conditions, there are deficient pipes downstream of the Project along Pachetti Way, Songdroth Way, and San Antonio Circle. Several of the deficient pipes are surcharging ($d/D \geq 1$). The Project adds flow to these deficient pipes, but does not increase the number of deficient pipes. The Project also increases the deficiency in existing deficient pipes along Pachetti Way, but does not result in an increase in the number of deficient pipes.

5.4. Future Cumulative Condition (2030) Results

5.4.1. Hydraulic Model Information

The Future Cumulative Condition model is created based on the West Yost (2017) model assuming the CIPs recommended in the West Yost (2017) report have been constructed per the *Showers Drive Sanitary Sewer Improvement Project 35% Design Submittal* (2017), which includes the relocation of the Alma Recorder further north of Alma Street. CIP#32 under the 2030 General Plan Update Utility Impact Study (2030 GPUUIS; IEC, October 2011) is assumed to be constructed for the Future Cumulative Condition. Previous UIS studies conducted by Schaaf & Wheeler within the San Antonio Precise Plan (SAPP) indicate that this CIP is still required to meet d/D performance Criteria for the FCC sewer flows. Project sewer flow is assumed to discharge into the 8-inch diameter public main in California Street.

5.4.2. Peak Wet Weather Flow (PWWF) Scenario – Pre and Post Project

The system does meet d/D performance criteria downstream of the Project in the Future Cumulative Condition pre-Project with the CIPs recommended in the West Yost (2017) report and with CIP #32 from the GPUUIS. The system does not meet d/D performance criteria under post-Project conditions for one pipe, the deficient pipe corresponding Pipe ID is 3737.

5.4.3. Deficiencies – Pre and Post Project

Table 5-4 presents the comparison of d/D criteria pre- and post-Project for pipes downstream of the Project development in the Future Cumulative Condition. The West Yost (2017) report identified several sewer mains along the flow path to be upsized, including pipes along San Antonio Circle and crossing Central Expressway. An additional pipe (Pipe ID 3746) from CIP #32 of the GPUUIS has been recommended for upsizing to meet d/D requirements under pre-Project conditions. West Yost (2017) recommended pipe diameters are given in bold purple font in Table 5-5, the recommended pipe diameter for CIP #32 is given in bold green font.

Under post-Project conditions, one newly deficient pipe does not meet d/D performance criteria in the Future Cumulative Condition. Schaaf & Wheeler recommends upsizing Pipe ID 3737 from an 8-inch diameter to a 10-inch diameter pipe to accommodate additional sewer flows. This recommended CIP is identified as SW_SAPP01 in Table 5-6.

5.4.4. Alma Recorder Contractual Limit

The Project is located in the Alma Recorder tributary area; flow from this area is contractually limited to two million gallons per day of PWWF. In the Existing Condition, flow to the Alma Recorder during PWWF is 14% and 13% below the contractual limit for pre-Project and post-Project respectively. In the Future Cumulative Condition, flow to the Alma Recorder is 8% below the contractual limit both pre- and post-Project.

Table 5-4: Existing Condition Model Results – Pre and Post Project

Sewer Main ID	Upstream MH ID	Downstream MH ID	Existing Diameter (in)	Length (ft)	Slope (%)	ADWF				PWWF				
						Pre-Project		Post-Project		Pre-Project		Post-Project		
						Max Flow (MGD)	d/D	Max Flow (MGD)	d/D	Max Flow (MGD)	d/D	Max Flow (MGD)	d/D	Pipe Capacity Remaining (% of Allowed d/D)
821	F1-056	F1-101	8	298	0.351	0.069	0.2587	0.087	0.2889	0.106	0.3209	0.132	0.3598	28
868	F1-101	F1-017	8	309	0.461	0.073	0.3498	0.090	0.3723	0.111	0.4218	0.137	0.4512	10
867	F1-017	F2-058	8	263	0.694	0.247	0.3787	0.264	0.3925	0.339	0.4531	0.364	0.4718	6
795	F2-058	F2-104	8	50	2.423	0.252	0.3142	0.269	0.3251	0.351	0.3768	0.376	0.3918	22
785	F2-104	F2-272	8	19	2.183	0.255	0.3826	0.272	0.3961	0.355	0.4622	0.380	0.4812	4
3737	F2-272	F2-284	8	108	0.694	0.257	0.3980	0.274	0.4120	0.360	0.4788	0.385	0.4976	0
754	F2-284	F2-282	8	96	2.011	0.258	0.2839	0.275	0.2934	0.361	0.3382	0.386	0.3505	30
3744	F2-282	F2-276	8	25	10.164	0.258	0.2734	0.275	0.2879	0.362	0.6288	0.387	0.6333	0
725	F2-276	F1-034	10	269	0.298	0.709	0.6813	0.726	0.6935	0.981	1.0000	1.003	1.0000	0
686	F1-034	F1-028	10	259	0.367	0.718	0.6813	0.735	0.6926	0.995	1.0000	1.017	1.0000	0
659	F1-110	F1-108	10	23	0.516	0.736	0.6447	0.753	0.6595	1.024	1.0000	1.046	1.0000	0
3717	F1-028	F1-110	10	17	0.006	0.736	0.6386	0.753	0.6462	1.023	1.0000	1.045	1.0000	0
3746	F1-108	F1-018	10	261	0.307	0.737	0.7867	0.754	0.8041	1.025	1.0000	1.047	1.0000	0
618	F1-018	F1-012	10	312	0.337	0.767	0.7284	0.784	0.7400	1.083	0.8993	1.105	0.9024	0
580	F1-012	E1-033	15	108	0.554	1.238	0.4832	1.238	0.4873	1.724	0.5775	1.746	0.5919	21
570	E1-033	E1-037	15	13	0.171	1.487	0.3671	1.508	0.3701	2.493	0.4405	2.556	0.4497	40
567	E1-037	E1-035	15	23	10.448	1.223	0.2036	1.241	0.2051	1.846	0.2534	1.868	0.2547	66
564	E1-035	SPS	30	38	20.814	1.224	0.0711	1.241	0.0716	1.864	0.0871	1.881	0.0874	88

Table 5-5: Future Cumulative Condition Model Results – Pre and Post Project

Sewer Main ID	Upstream MH ID	Downstream MH ID	Model Diameter (in)	Length (ft)	Slope (%)	ADWF				PWWF				
						Pre-Project		Post-Project		Pre-Project		Post-Project		
						Max Flow (MGD)	d/D	Max Flow (MGD)	d/D	Max Flow (MGD)	d/D	Max Flow (MGD)	d/D	Pipe Capacity Remaining (% of Allowed d/D)
821	F1-056	F1-101	8	298	0.351	0.069	0.2587	0.087	0.2887	0.106	0.3216	0.132	0.3602	28
868	F1-101	F1-017	8	309	0.461	0.073	0.3505	0.090	0.3729	0.112	0.4240	0.138	0.4532	9
867	F1-017	F2-058	8	263	0.694	0.249	0.3814	0.265	0.3951	0.344	0.4577	0.368	0.4762	5
754	F2-284	F2-282	8	96	2.011	0.265	0.2877	0.281	0.2970	0.372	0.3437	0.397	0.3558	29
3737	F2-272	F2-284	8/10	108	0.694	0.264	0.4034	0.281	0.4171	0.370	0.4869	0.395	0.5055/ 0.3645	0/14
785	F2-104	F2-272	8	19	2.183	0.261	0.3877	0.278	0.4010	0.366	0.4703	0.391	0.4892	2
795	F2-058	F2-104	8	50	2.423	0.258	0.3182	0.275	0.3289	0.362	0.3831	0.387	0.3979	20
3744	F2-282	F2-276	8	25	10.164	0.265	0.2204	0.282	0.2273	0.373	0.2617	0.398	0.2705	46
725	F2-276	F1-034	10	269	0.372	0.288	0.4029	0.297	0.4095	0.388	0.4774	0.400	0.4858	3
686	F1-034	F1-028	10	259	0.367	0.300	0.4106	0.309	0.4169	0.407	0.4857	0.419	0.4936	1
659	F1-110	F1-108	12	23	0.516	0.319	0.3572	0.328	0.3616	0.436	0.4126	0.449	0.4179	16
3717	F1-028	F1-110	10	17	0.006	0.319	0.4204	0.327	0.4259	0.435	0.4897	0.447	0.4966	1
3746	F1-108	F1-018	15	261	0.384	0.319	0.3153	0.328	0.3193	0.438	0.3788	0.450	0.3838	49
618	F1-018	F1-012	15	312	0.337	0.792	0.4394	0.809	0.4436	1.126	0.5430	1.151	0.5489	27
580	F1-012	E1-033	15	108	0.433	1.297	0.5159	1.314	0.5200	1.846	0.6532	1.859	0.6567	12
WY-01	E1-033	E1-037	15	13	0.333	1.298	0.5518	1.315	0.5562	1.848	0.7001	1.861	0.7039	6
WY-02	E1-037	E1-035	15	23	0.301	1.299	0.4795	1.315	0.4832	1.849	0.5981	1.862	0.6010	20
WY-03	JCT-12	E1-035	15	16	0.500	1.299	0.4538	1.315	0.4569	1.849	0.5477	1.862	0.5498	27
WY-04	JCT-14	JCT-12	15	214	0.836	1.299	0.4090	1.315	0.4120	1.849	0.5015	1.862	0.5036	33
WY-05	E1-035	SPS	30	38	17.323	1.299	0.0764	1.316	0.0768	13.849	0.2397	13.863	0.2399	68

Notes: Pipe diameter in purple denotes West Yost CIP, pipe diameter in green denotes CIP #32 from the GPUUIS, pipe diameter in blue denotes new Project specific Schaaf & Wheeler CIP

Table 5-6 Pipes Recommended for Upsizing and Percentage of Contributed Flow

CIP	Sewer Main ID	Upstream MH ID	Downstream MH ID	Existing Diameter (in)	Proposed Diameter (in)	Total Future Cumulative ADWF Flow With Project (MGD)	Project Incremental Contribution		City of Mountain View Contribution	
							ADWF Flow (MGD)	Percentage of Total Flow (%)	ADWF Flow (MGD)	Percentage of Total Flow (%)
SW_SAPP01	3737	F2-272	F2-284	8	10	0.281	0.017	6	0.264	94
CIP #32	3746	F1-108	F1-018	10	15	0.328	0.009	3	0.319	97
West Yost CIP	659	F1-110	F1-108	10	12	0.328	0.009	3	0.319	97
	618	F1-018	F1-012	10	15	0.809	0.017	2	0.792	98
	580	F1-012	E1-033	15	15	1.314	0.017	1	1.297	99
	WY-01	E1-033	E1-037	#N/A	15	1.315	0.017	1	1.298	99
	WY-02	E1-037	E1-035	#N/A	15	1.315	0.017	1	1.299	99
	WY-03	JCT-12	E1-035	#N/A	15	1.315	0.017	1	1.299	99
	WY-04	JCT-14	JCT-12	#N/A	15	1.315	0.017	1	1.299	99
WY-05	E1-035	SPS	#N/A	30	1.316	0.017	1	1.299	99	

Notes: Pipe diameter in purple denotes West Yost CIP, pipe diameter in green denotes CIP #32 from the GPUUIS, pipe diameter in blue denotes new Project specific Schaaf & Wheeler CIP

Chapter 6. Storm System Impact

The storm drain system analysis for Project impact is based on the MIKE URBAN (MU) model developed as part of the *City of Mountain View Storm Drain Master Plan (SDMP; Schaaf & Wheeler, 2019)*, which analyzed existing 12-inch and larger diameter storm drainage pipe. The Project site is within the Adobe Creek watershed, discharging to Adobe Creek near Alma Street. The Project is assumed to maintain the existing drainage direction by connecting to the existing 30-inch storm drain pipe along California Street. The Project's impact is evaluated for the 10-year design storm.

6.1. Impervious Area Change and Hydrologic/Hydraulic Change

The existing site impervious percentage is 79%, the Project development will increase the impervious percentage to 95% based on the Project Description provided March 11, 2021. This increase in impervious area results in an increase in peak runoff; the estimated incremental increase in flow to the existing storm drain network due to Project development is 0.09 cfs, or approximately 3% of the existing runoff peak flow. Model results show the hydraulic grade line at the connection point to the City's storm drain system increases by 0.01 ft with Project development.

6.2. Project Contribution to Existing Deficiencies

The SDMP identifies the California Street and San Antonio storm drain system as having sufficient capacity to convey site runoff. However, there are existing drainage deficiencies downstream of the Project. The existing 6.5-foot diameter trunk line connecting the San Antonio Road storm drain trunk line to Adobe Creek does not have the capacity to convey the 10-year runoff when creek levels are high. The existing line currently operates in a surcharged condition in the hydraulic model at various points along its length. Additional conveyance capacity is required to convey existing runoff and maintain the 10-year service level. The SDMP recommends a Capital Improvement Project (CIP) that includes upsizing the 6.5-foot diameter pipe to an 8-foot diameter pipe or adding a parallel line which provides the equivalent capacity.

The Project is not anticipated to have a significant impact on the existing storm drain network or result in additional deficiencies downstream of the Project. With Project development, the peak runoff is anticipated to increase by approximately 0.03 cfs, or approximately 3% of the existing runoff peak flow. Additionally, model results indicate that the hydraulic grade line at the connection point to the City's storm drain system increases by 0.01 ft with Project development. At existing surcharge locations downstream of the Project, surcharge levels remain approximately equal to the pre-Project levels (i.e., less than 0.01 ft different).

APPENDIX A:

Additional Considered Projects

Table A-1: Additional Considered Projects

ID	Address	Project Description	Status
29	2645 - 2655 Fayette Drive	Mixed-use; 44-unit condominium building and a 6,900 square foot commercial building	Approved
35	369 North Whisman Road	Two office buildings totally 180,773 square feet	Approved
36	1411 – 1495 West El Camino Real	53-unit condominium building	Approved
37	701 West Evelyn Avenue	commercial building; 6,500 square feet retail and 28,090 square feet of office	Approved
38	851 - 853 Sierra Vista Avenue	9 unit rowhouse development	Approved
39	1958 Latham Street	6 unit rowhouse development	Approved
40	231 - 235 Hope Street	8 unit condo	Approved
44	1555 West Middlefield Road	115-unit rowhouse development	Approved
45	410 - 414 Sierra Vista Avenue	14-unit rowhouse development	Approved
46	2019 Leghorn Street	12,050 square-foot office building	Approved
47	855 - 1023 West El Camino Real	mixed-use 60-bed senior memory care facility with 5,883 square feet of ground floor retail and restaurant uses	Approved
49	2300 West El Camino Real	75,824 square foot, 153-room hotel	Approved
50	1313 and 1347 West El Camino Real	mixed-use project with 24 apartment units above ground floor commercial space	Approved
52	676 West Dana Street	20,166 square foot mixed-use project with three floors of residential condominiums, 4,791 square feet of ground-floor commercial	Approved
53	828 and 836 Sierra Vista Avenue	20 unit rowhouse development	Approved
54	2580 and 2590 California Street / 201 San Antonio Circle	632 residential units and 20,000 square feet of commercial space	Under Construction
56	257 - 279 Calderon Avenue	16-unit rowhouse development	Under Construction
58	2044 and 2054 Montecito Avenue	52-unit rowhouse development	Under Construction

Source: ICF

Table A-1: Additional Considered Projects (Continued)

ID	Address	Project Description	Status
59	2700 West El Camino Real	211 apartment units and 2,000 square feet of ground floor commercial	Under Construction
60	858 Sierra Vista Avenue	4 small-lot, single-family homes	Under Construction
64	1045 - 1085 La Avenida	Renovate existing office buildings and construct an additional office building. The net new square footage is 128,000 square feet added to the existing 515,000 square feet of office space	Under Construction
67	315 and 319 Sierra Vista Avenue	15-unit rowhouse development	Under Construction
70	1950 Montecito Avenue	33-unit rowhouse development	Under Construction
71	950 West El Camino Real	71-unit affordable studio apartment development	Under Construction
72	1720 Villa Street	226-unit apartment complex	Under Construction
73	2005 Rock Street	8 rowhouse units and 7 townhome units	Under Construction
74	2310 Rock Street	55-unit rowhouse development	Under Construction
75	982 Bonita Avenue	8 condominium units	Under Construction
76	250 San Antonio Circle	3,350 square foot building for the Community School of Music and Arts	Under Construction

Source: ICF

APPENDIX B:

Figures

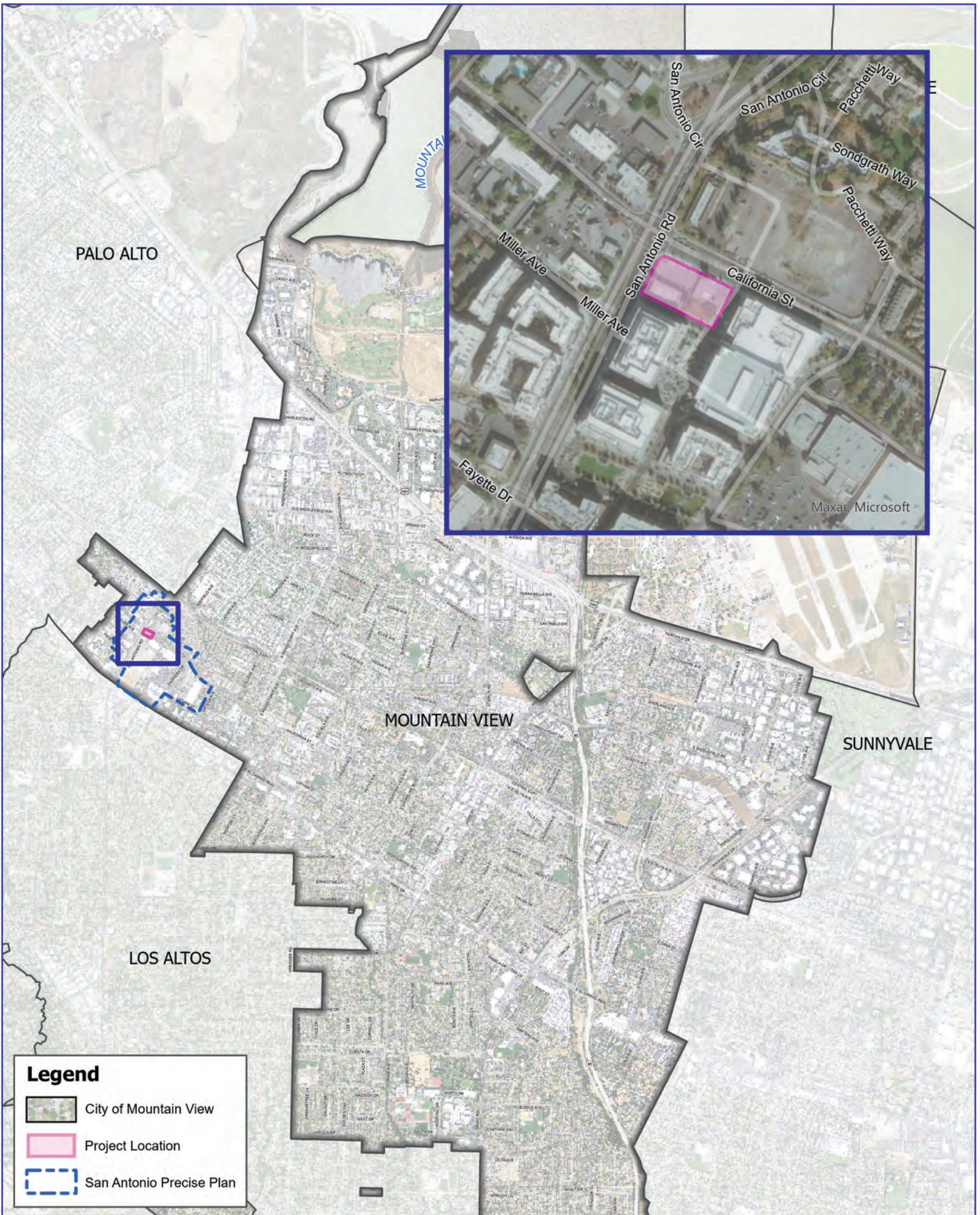

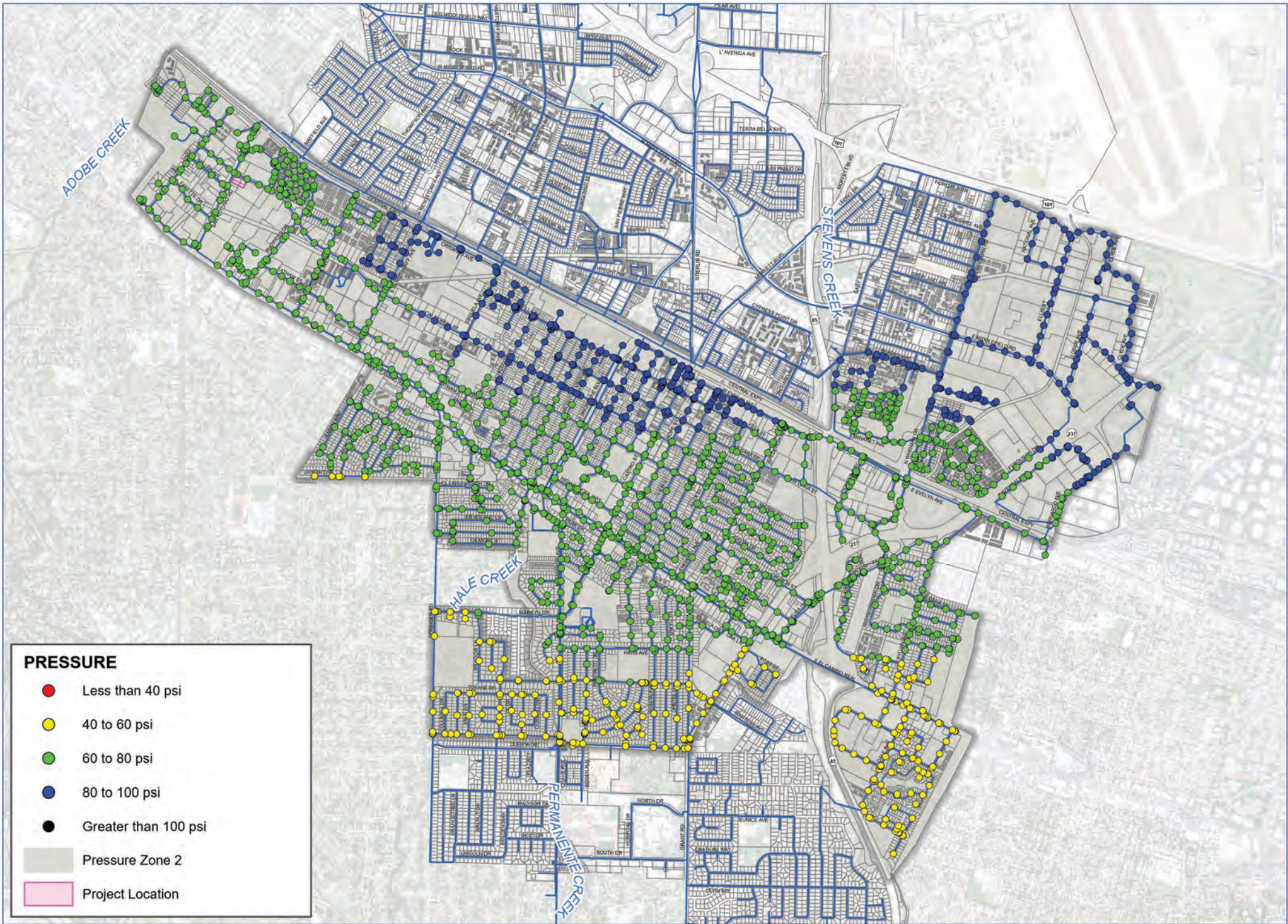

FIGURE 2:

July

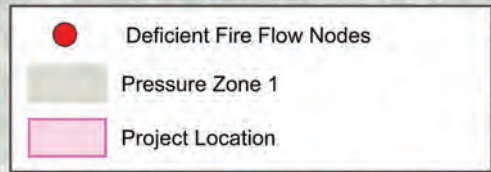
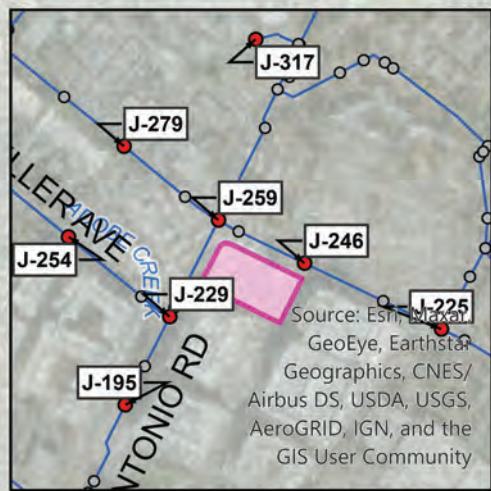
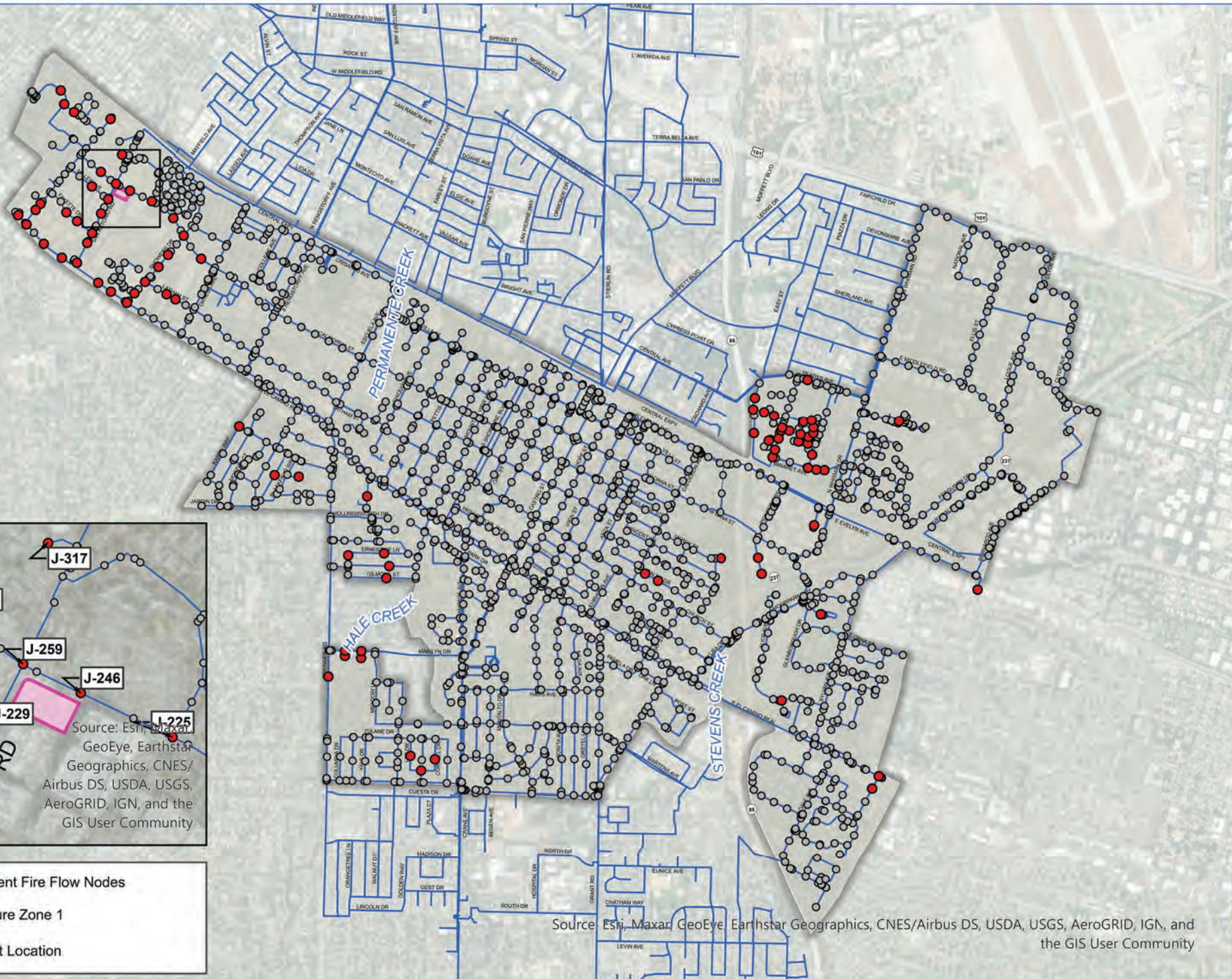

FIGURE 3:

Fire Flow Analysis (MDD+FF)
Water System Model - Existing Condition



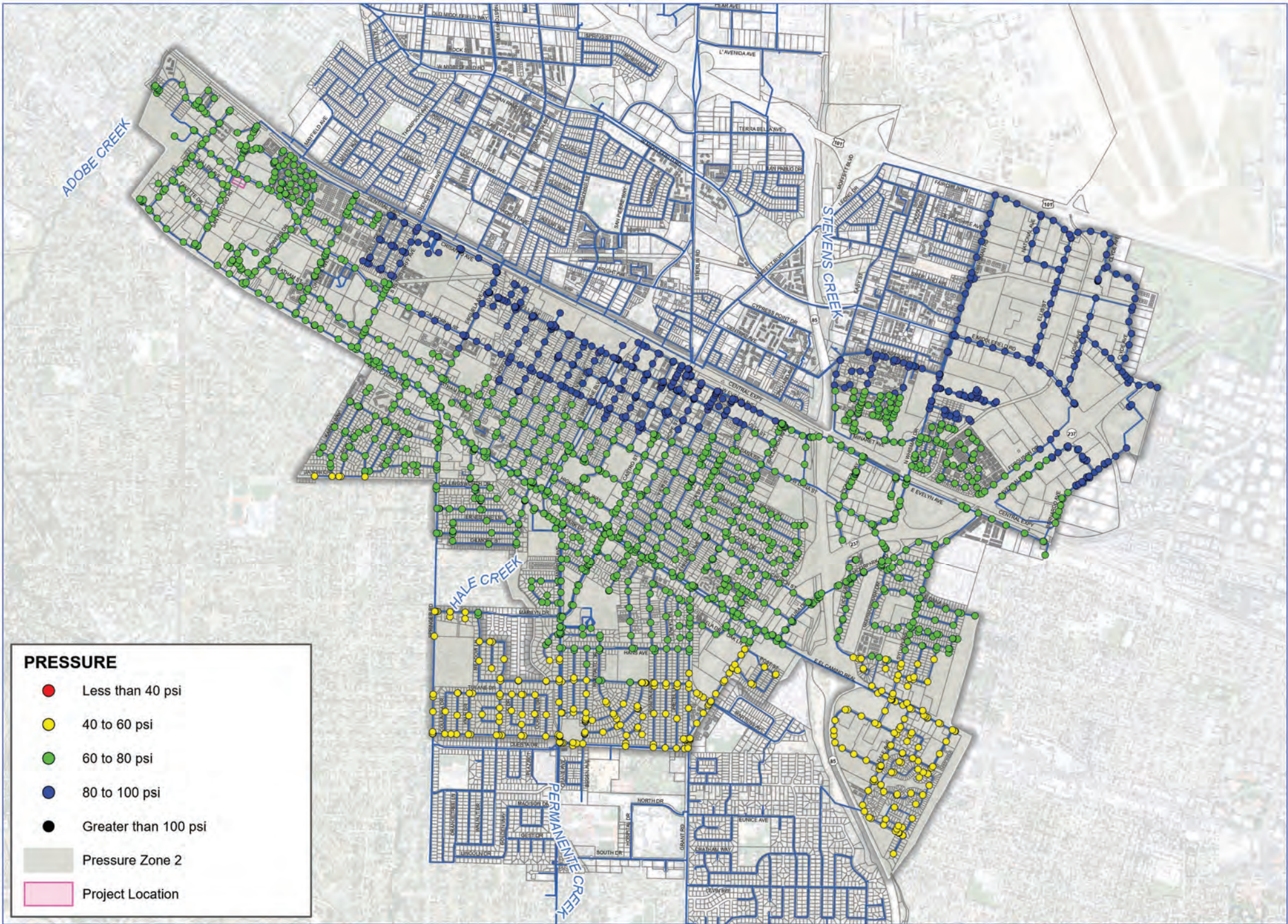
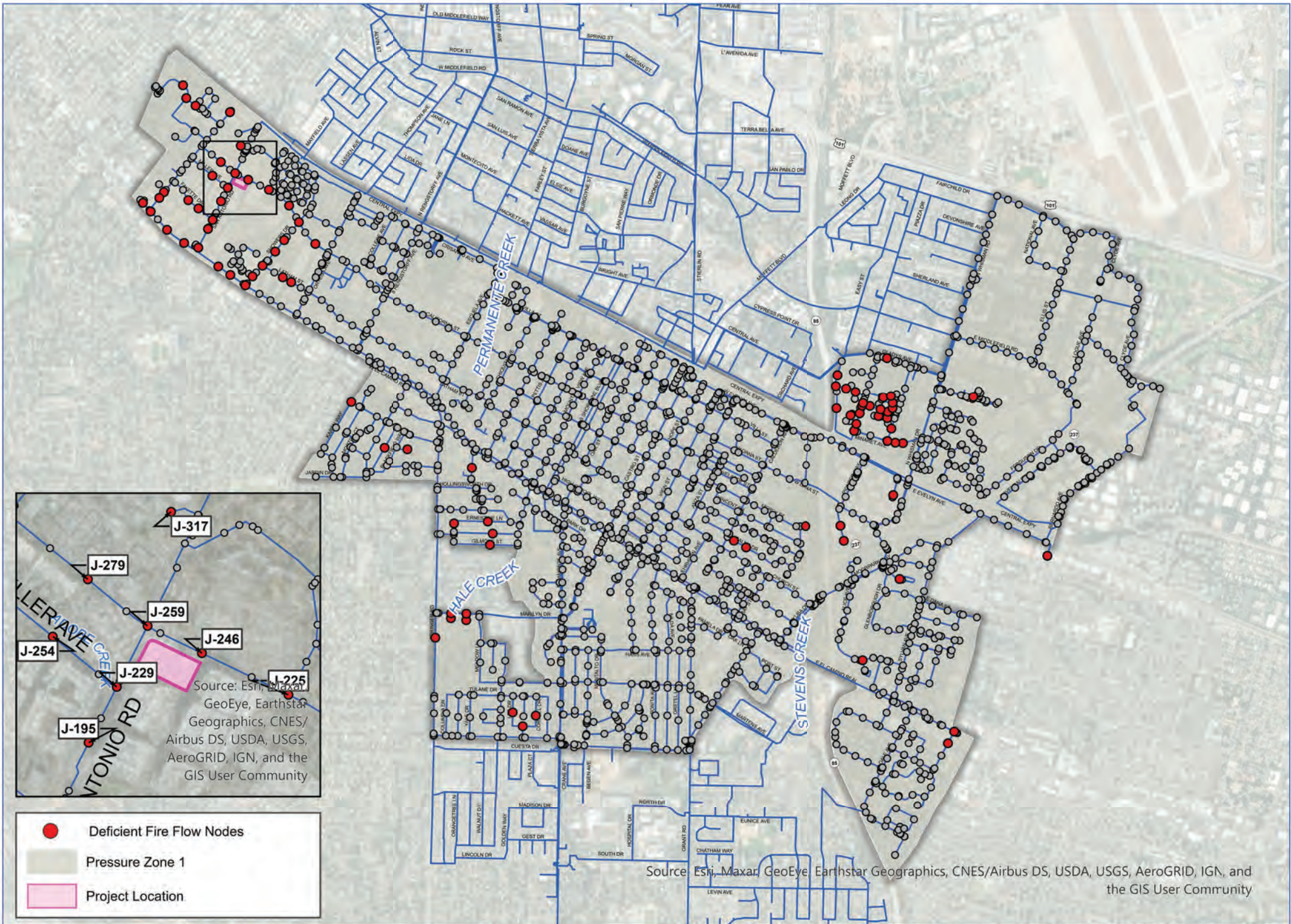

FIGURE 4:



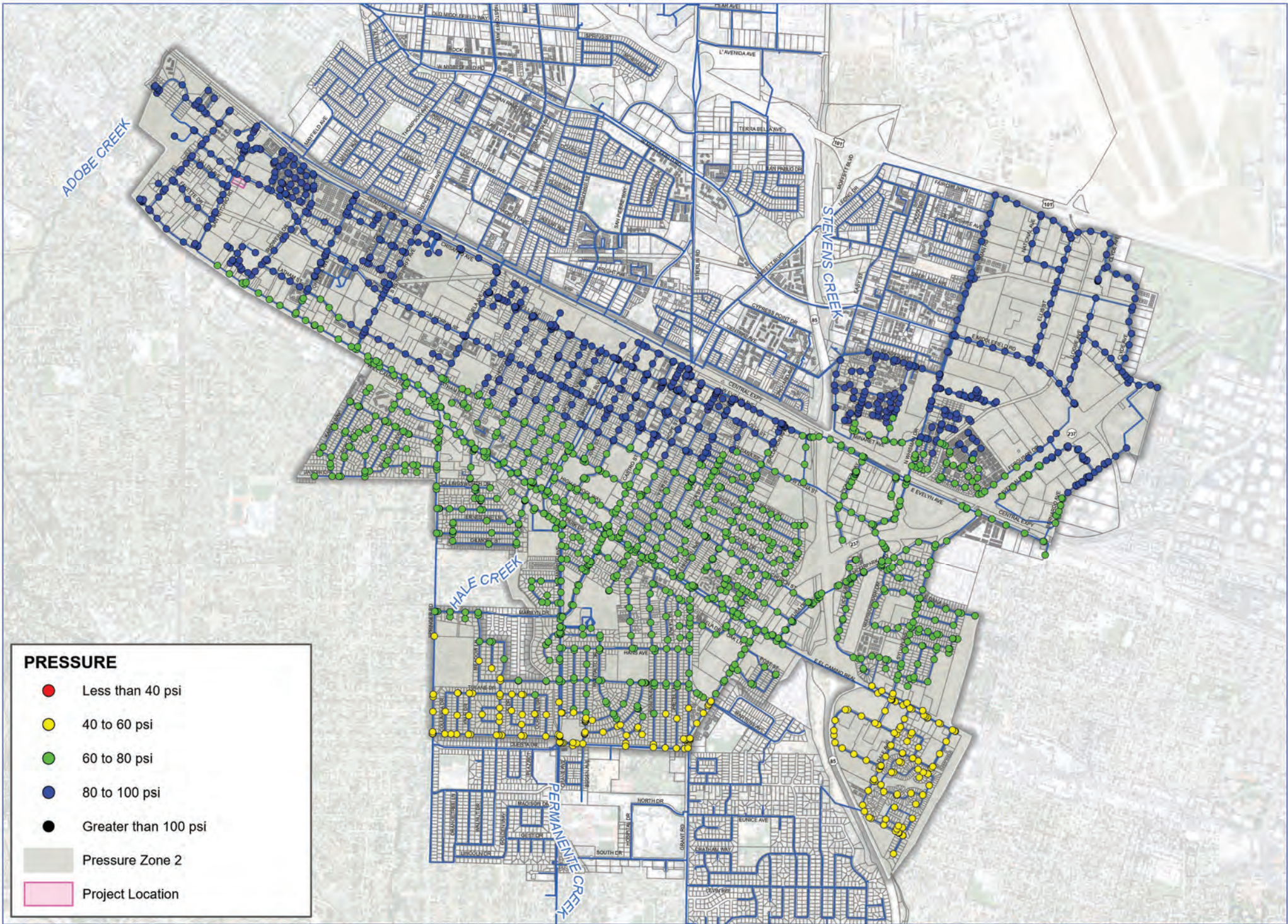

FIGURE 6:

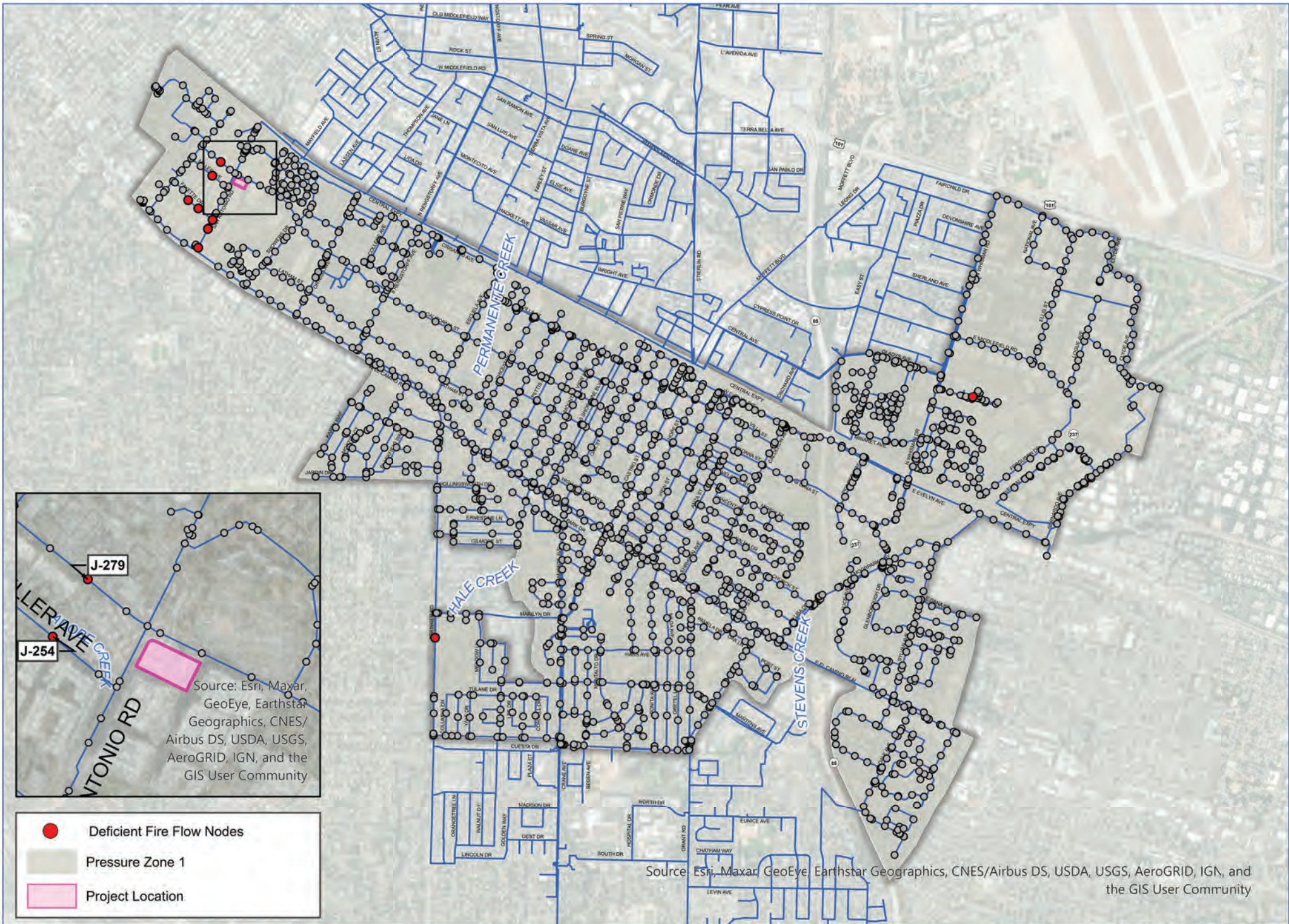

FIGURE 7:

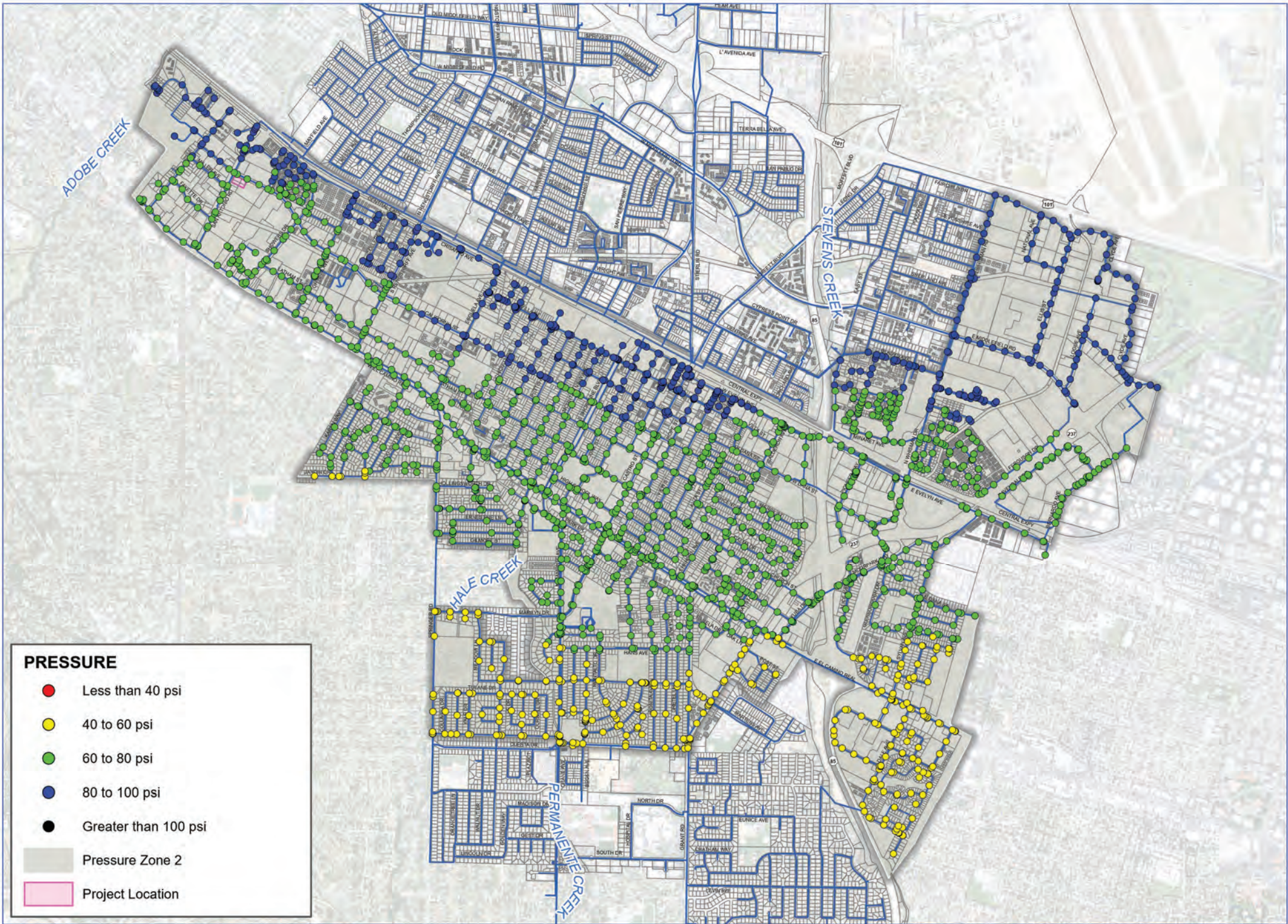

FIGURE 8:

Peak Hour Demand (PHD) with Project
Water System Model - Future Condition

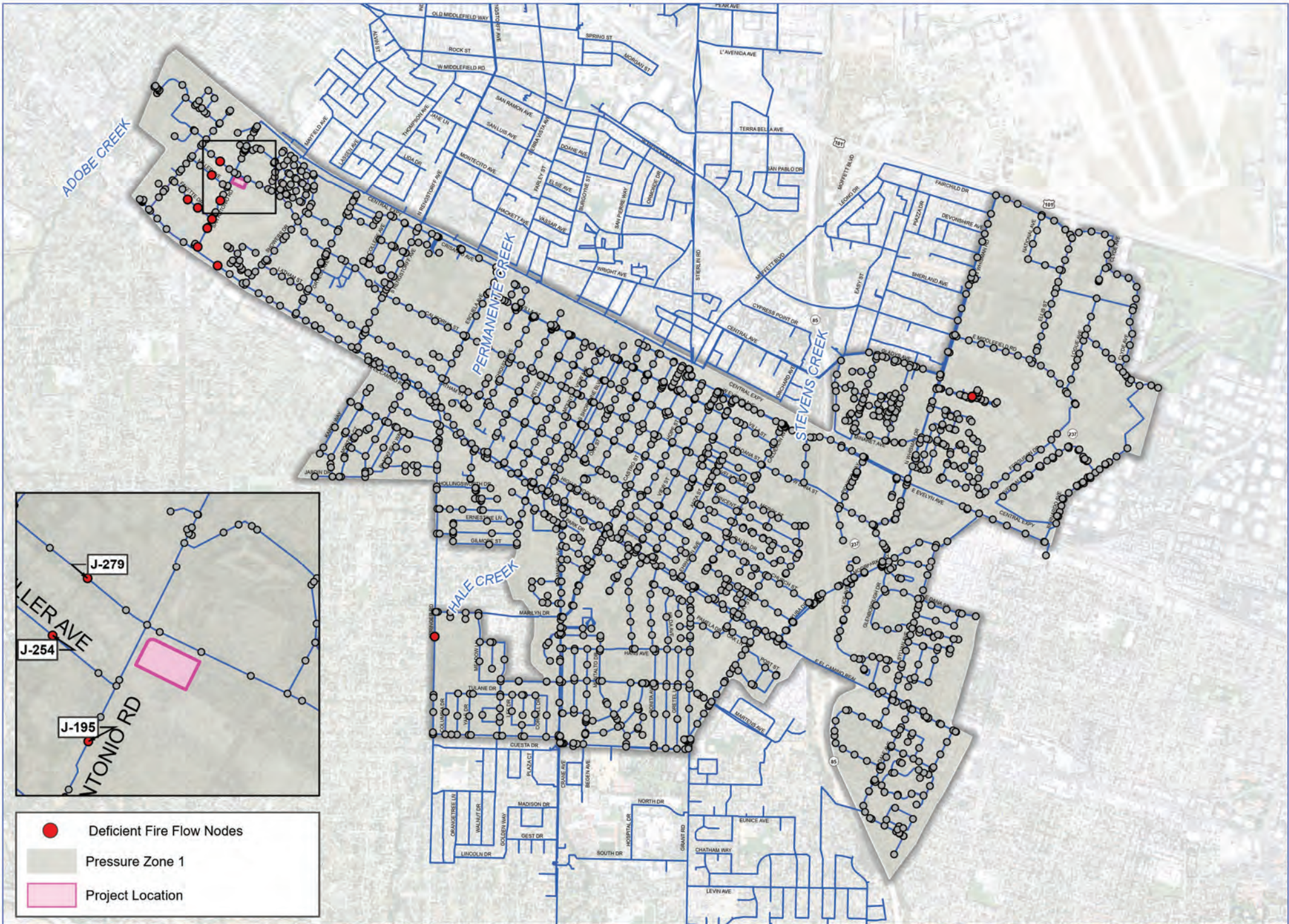
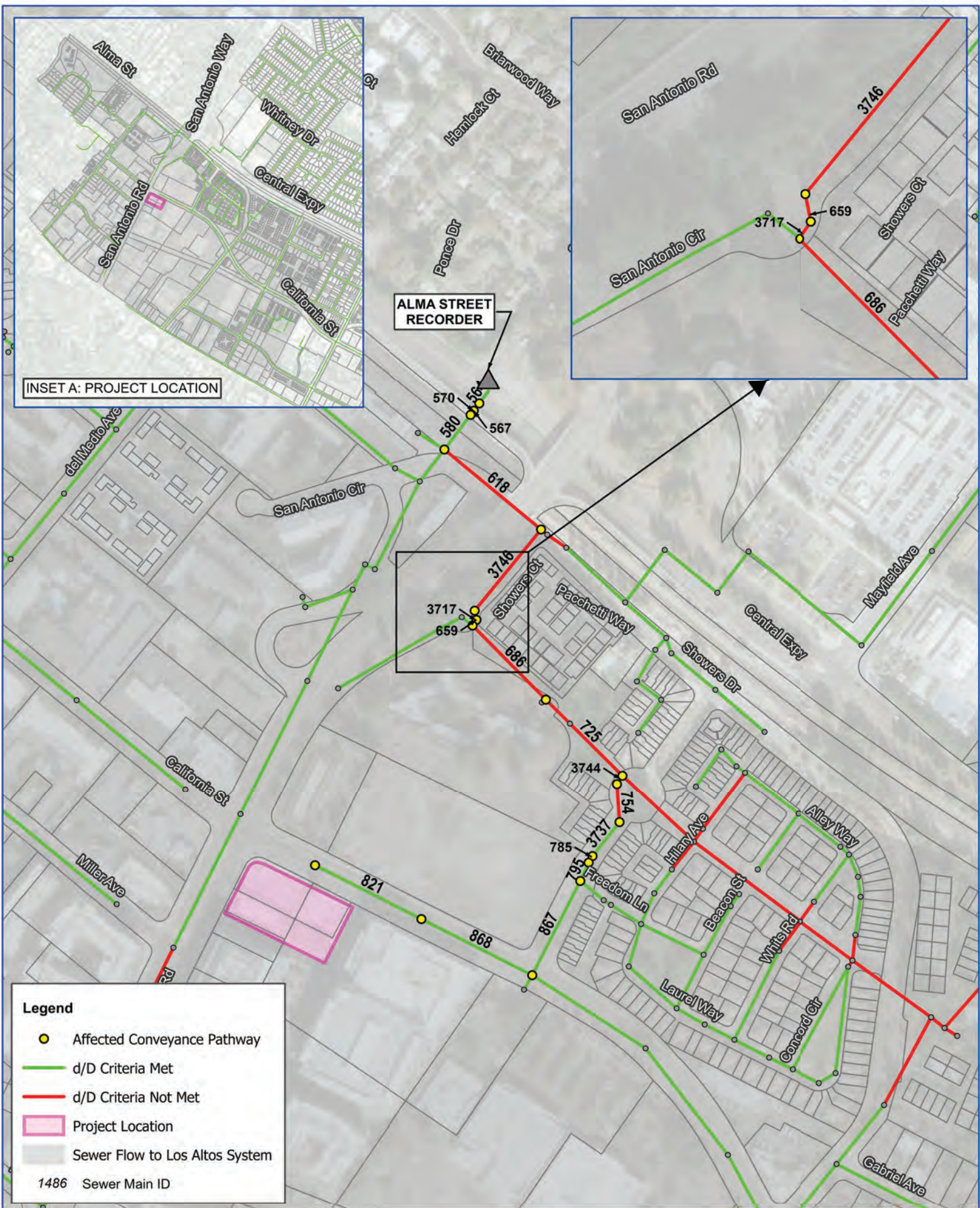
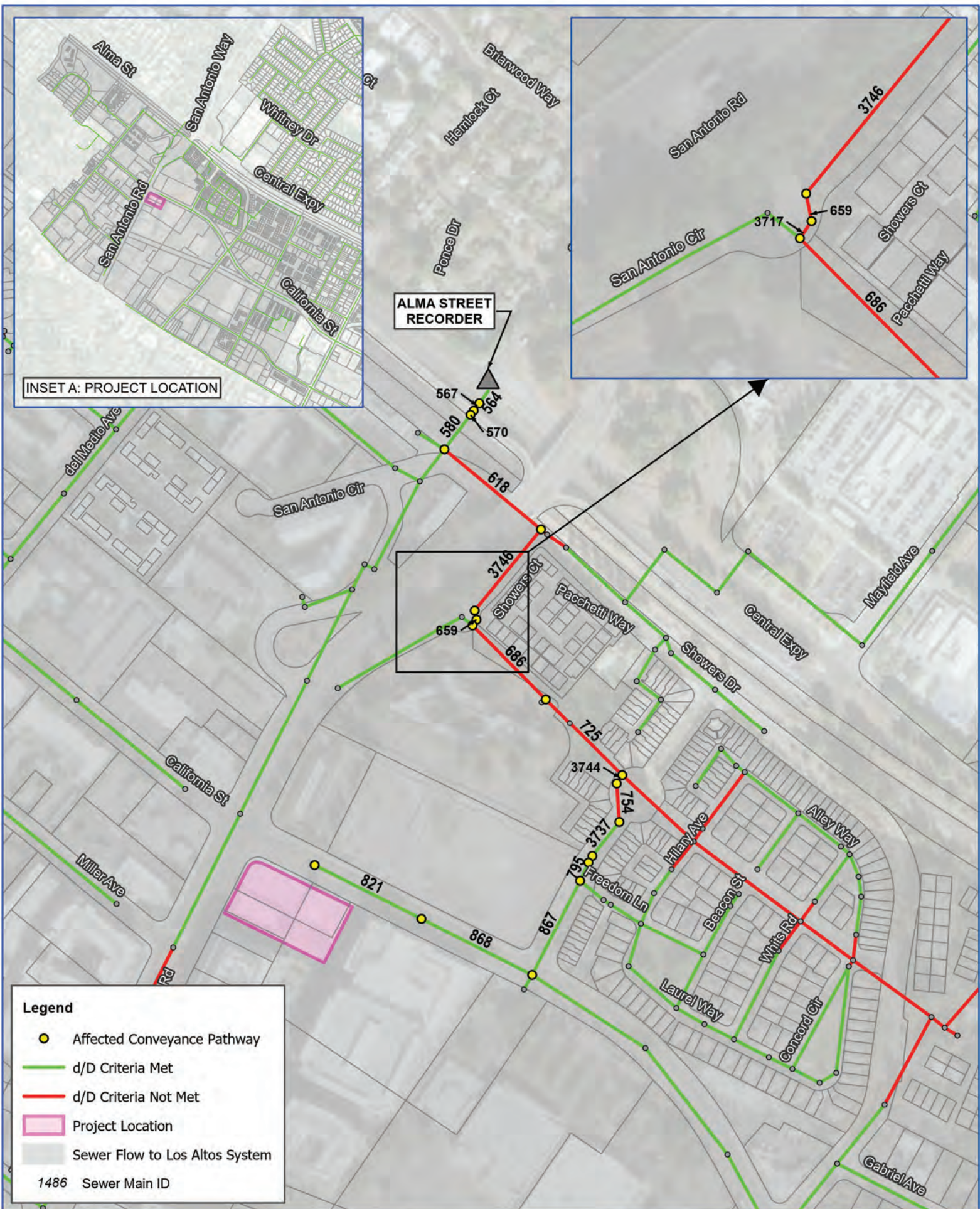
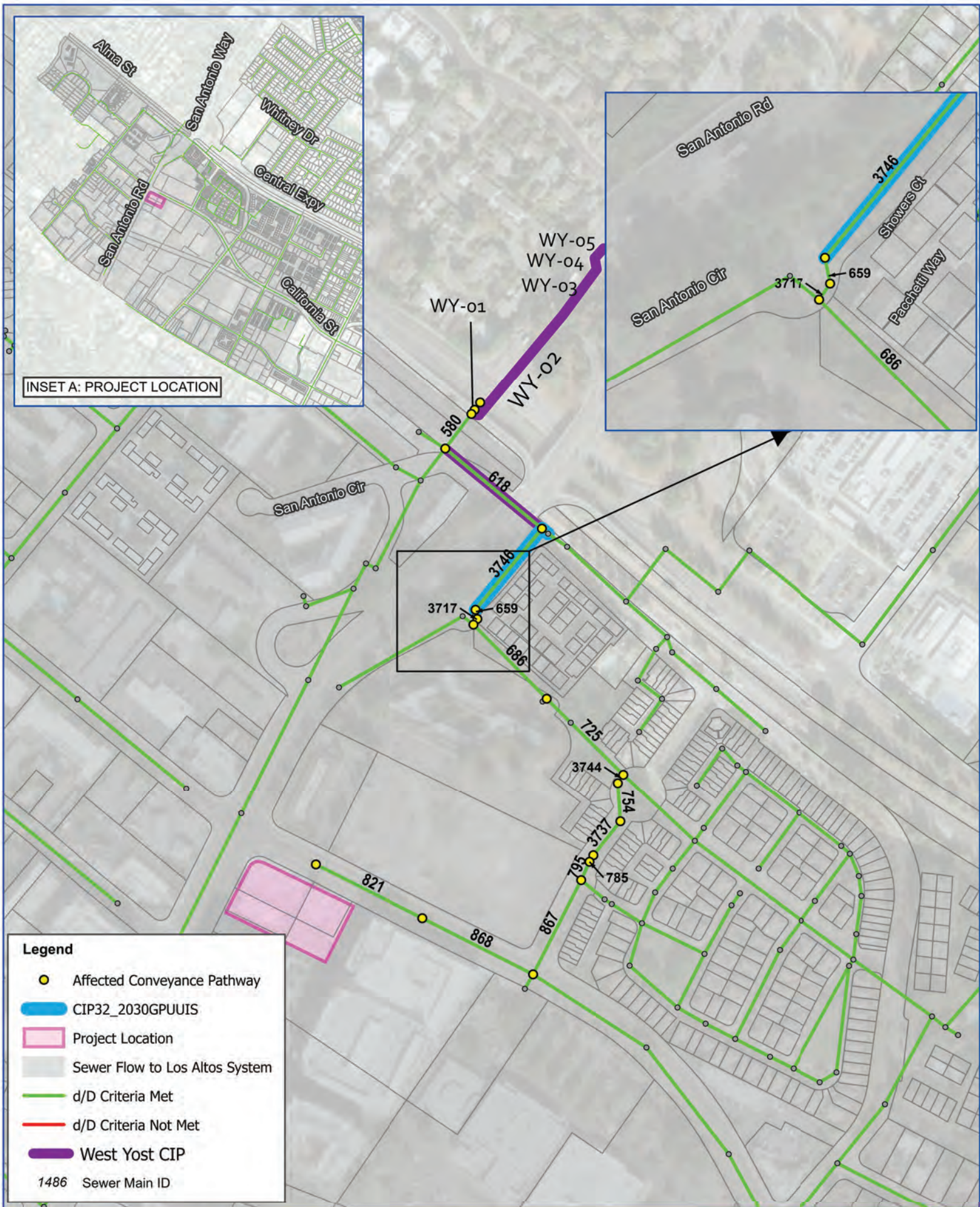

FIGURE 9:

Fire Flow Analysis (MDD+FF) with Project
Water System Model - Future Condition







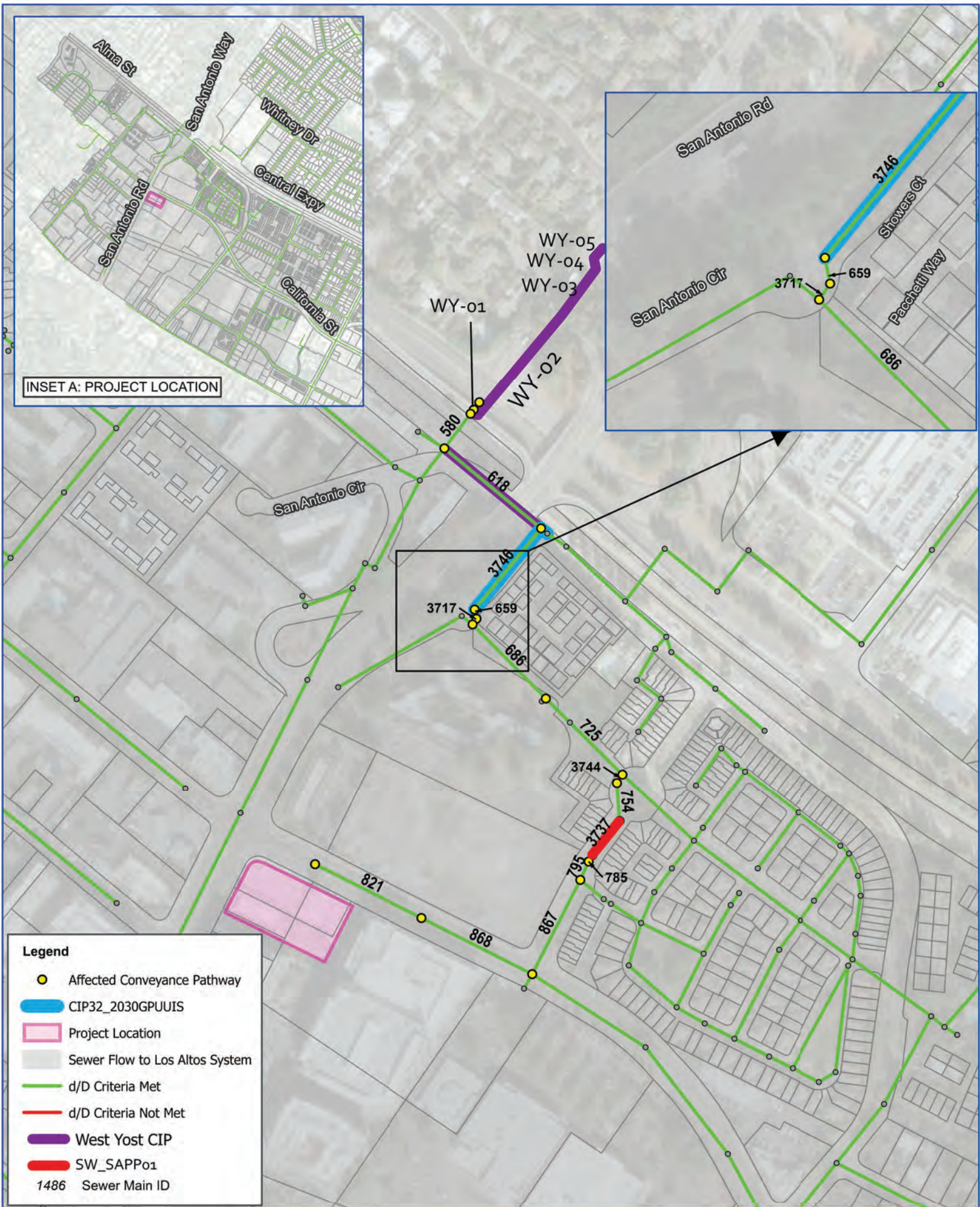

INSET A: PROJECT LOCATION

- Legend**
- Affected Conveyance Pathway
 - CIP32_2030GPUUIS
 - Project Location
 - Sewer Flow to Los Altos System
 - d/D Criteria Met
 - d/D Criteria Not Met
 - West Yost CIP
 - SW_SAPP01
 - 1486 Sewer Main ID



FIGURE 13:

PWWF - With Project

Future Condition - Sewer System Model

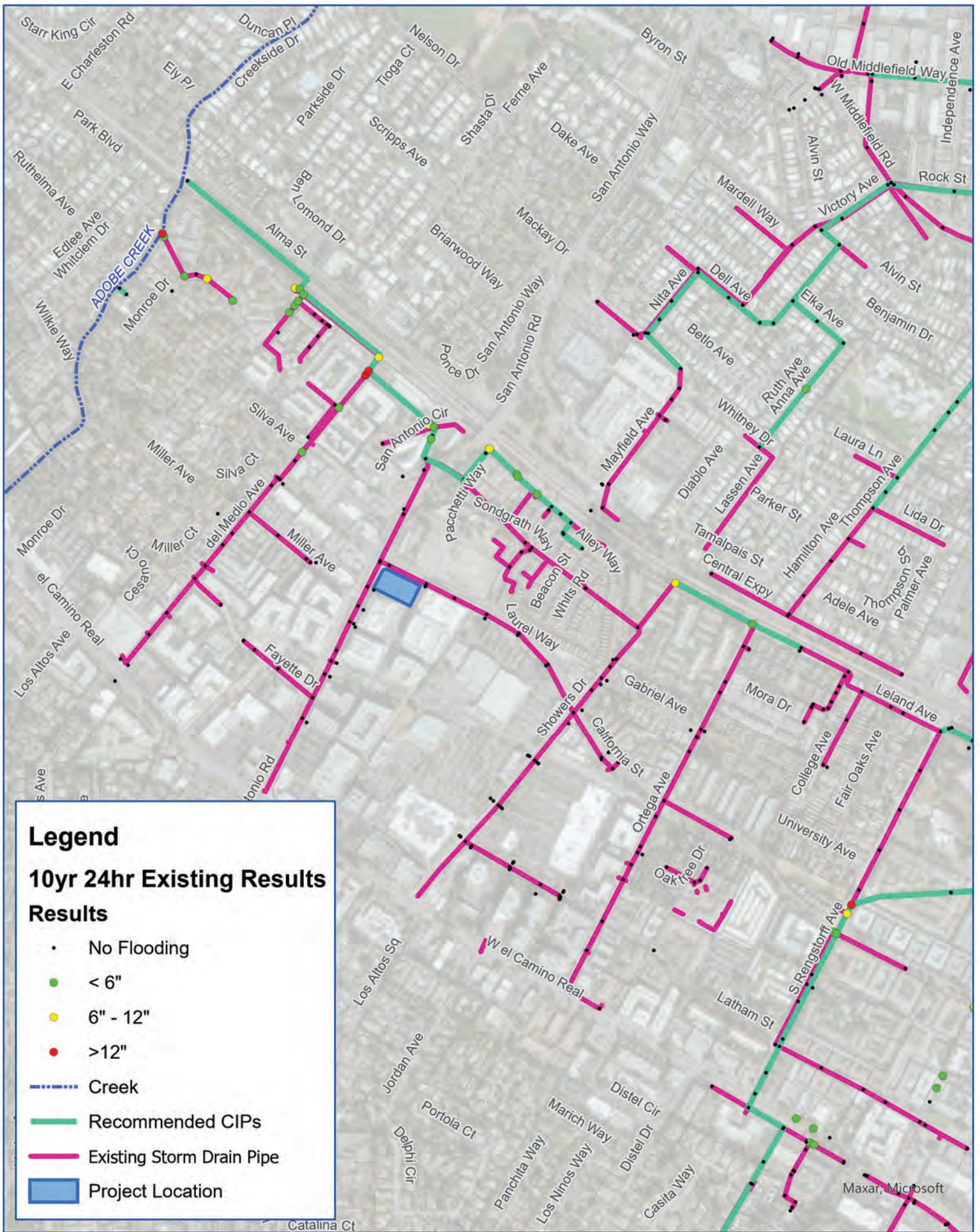

FIGURE 14: Storm Drain Existing 10yr Results