

HOTEL VALET PARKING MEMO

2300 WEST EL CAMINO REAL
MOUNTAIN VIEW, CALIFORNIA

SHORT TERM VALET PARKING

Patrons are able to check in or park for a short amount of time on the first parking level as one enters the hotel. These parking spaces are located close to the valet kiosk to make check in and valet accommodations work smoothly.

VALET STAFFING

There will be one person stationed permanently at the valet kiosk on the lobby level to greet arriving vehicles, open the vehicles doors, and hand over the claim ticket to the patron. In addition, there will be two alternating valet staff driving cars down to the valet only underground parking garage and retrieving vehicles from the Park Lifts. The valet kiosk and two valet parking staff will be in radio contact between the two levels, to create a fluid valet operation. The valet staff will access the two parking levels by the east stairwell by foot if needed.

SCHEDULING OF VALET STAFF

Scheduling of valet staff will be determined by both the hourly activity levels for arriving and departing the hotel, and the time needed to park and retrieve vehicles.

FIRST LEVEL VALET PARKING PLAN

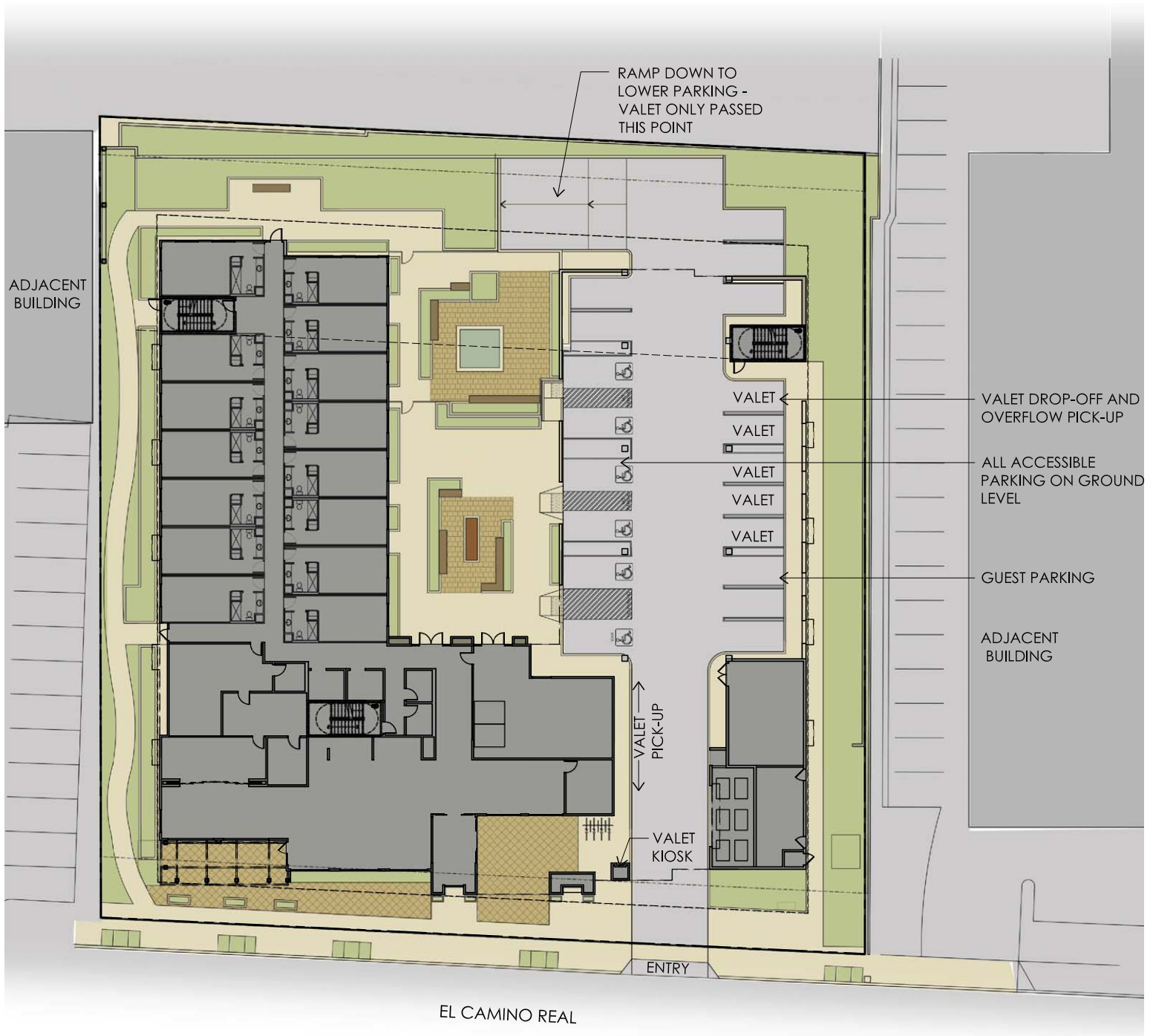

ARRIVAL

There are three guest parking spaces, and valet drop-off overflow parking for temporary parking while checking into the hotel. Once the claim ticket is given to the patron, the valet attendant would then call for a valet driver to park the vehicle. The valet driver would drive the vehicle down the ramp located at the rear of the site to the underground valet only parking garage. Once in the underground parking garage, the valet driver will park the car in an available space or on the Park Lift. When the first vehicle is parked in each Park Lift, the driver will lift the car up into the high position so the lift is ready to receive the second vehicle.

BASEMENT LEVEL VALET PARKING PLAN

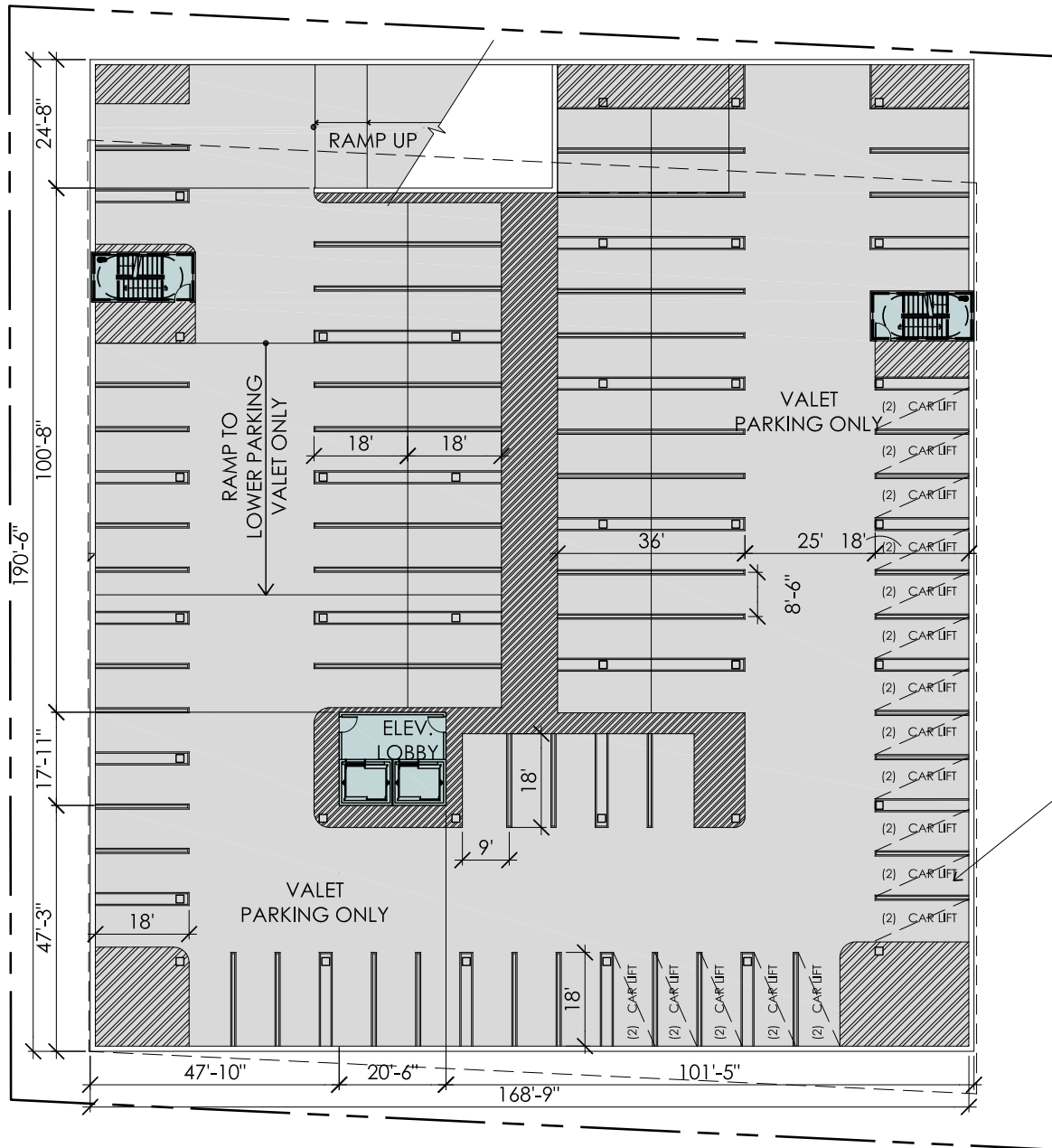

DEPARTURE

Once the patron is ready to retrieve their vehicle, the claim ticket will be given to the attendant at the valet kiosk on the first parking level. The attendant will radio the driver in the underground parking garage to retrieve the appropriate vehicle. Once the vehicle is off the Park Lift, the vehicle will be driven up the rear ramp and parked in the temporary valet parking spaces or pulled up along side the valet kiosk for curbside delivery.

VALET PARKING HIERARCHY

The single stall parking in the underground parking level will be used for guest vehicles staying for a short amount of time at the hotel and these spaces will be filled first. Next, the tandem parking will be utilized for vehicles that do not plan on retrieving their vehicle during their stay at the hotel. These cars will be parked in a tandem configuration and moved around during the day if a vehicle is needed from the inside stall. Lastly, the Park Lifts will be used for long term guests and as overflow valet parking. The vehicles will first be added to the Park Lift, which will eventually become the upper level vehicles. Once a vehicle is added to the Park Lift, the car will be raised up, to make room for a second vehicle.

PARKING LIFT DETAILS

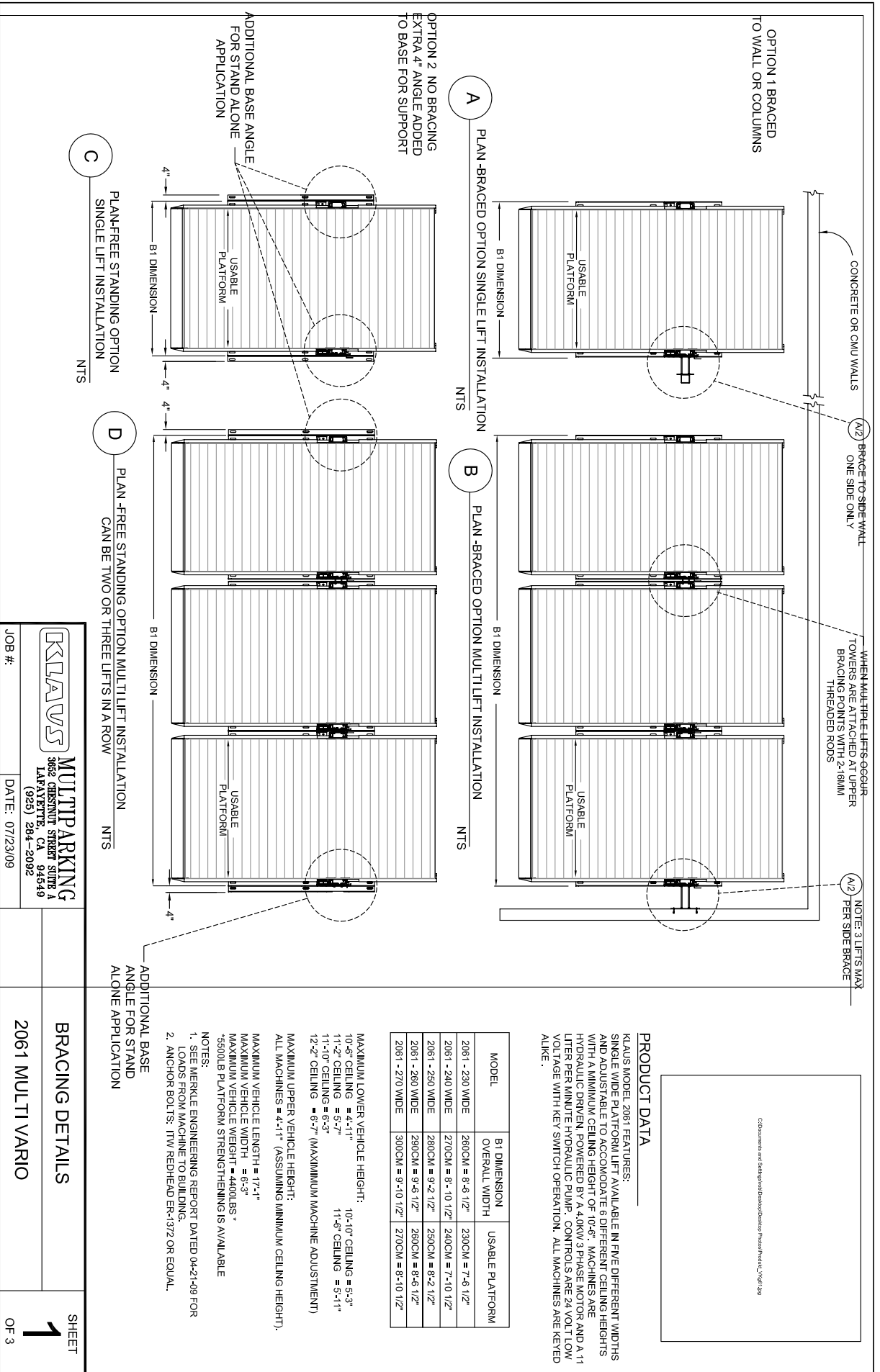

KLAVUS MULTIPARKING
 3652 CHESTNUT STREET SUITE A
 LAFAVETTE, CA 94549
 (925) 264-2092

JOB #: _____ DATE: 07/23/09

BRACING DETAILS

2061 MULTI VARIO

SHEET **1** OF 3

PARKING LIFT DETAILS

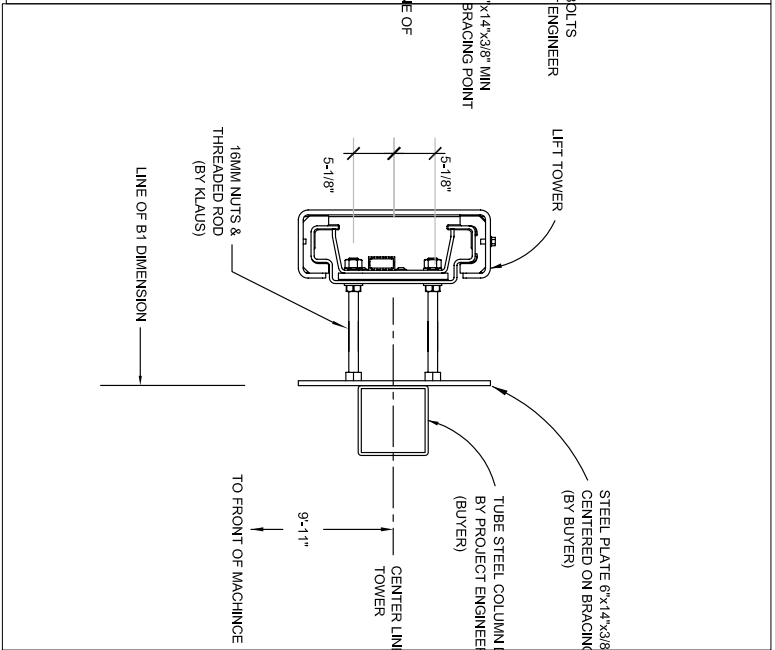
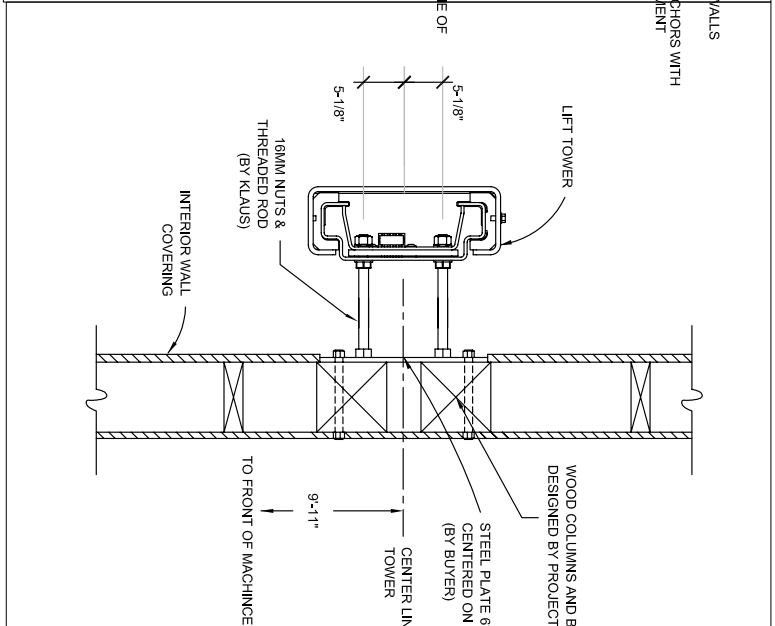
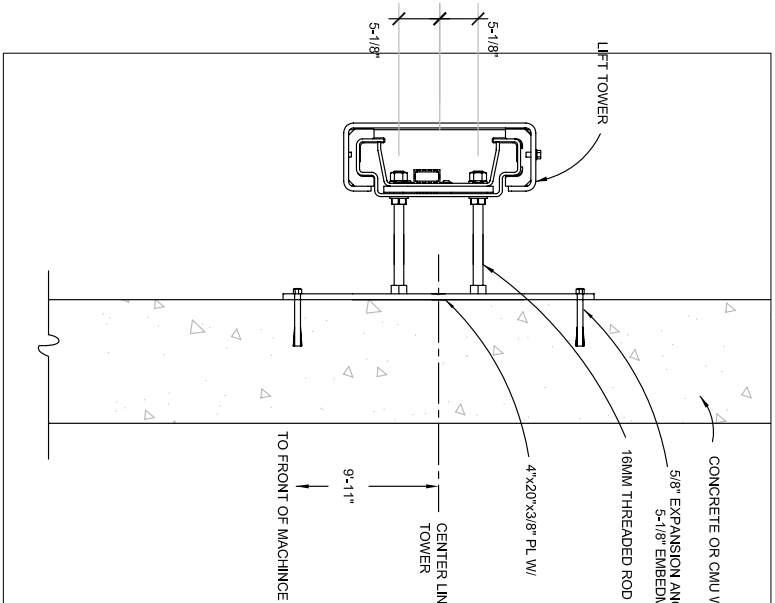

KLAUS
MULTIPARKING
3652 CHRISTOPHER STREET SUITE A
LAFAYETTE, CA 94549
(925) 284-2092

JOB #:
DATE: 07/23/09

BRACING DETAILS
2061 MULTI VARIO

SHEET
2
OF 3

PARKING LIFT SPECIFICATIONS

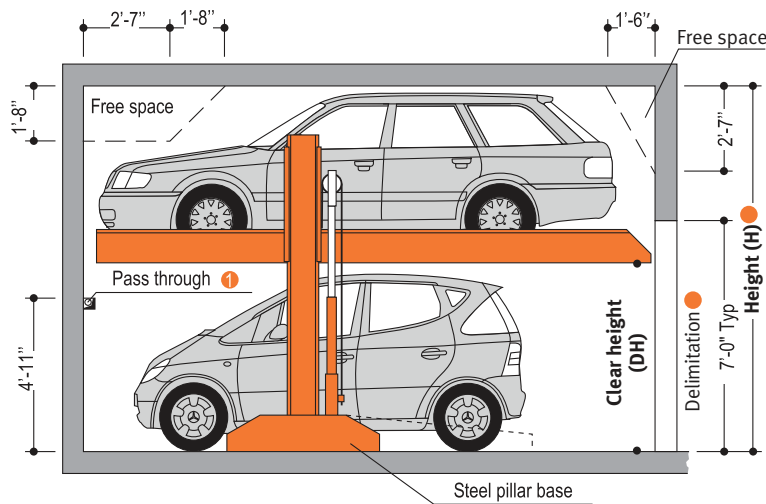

Before lowering the platform, the vehicle parked in the lower parking space must be driven off!

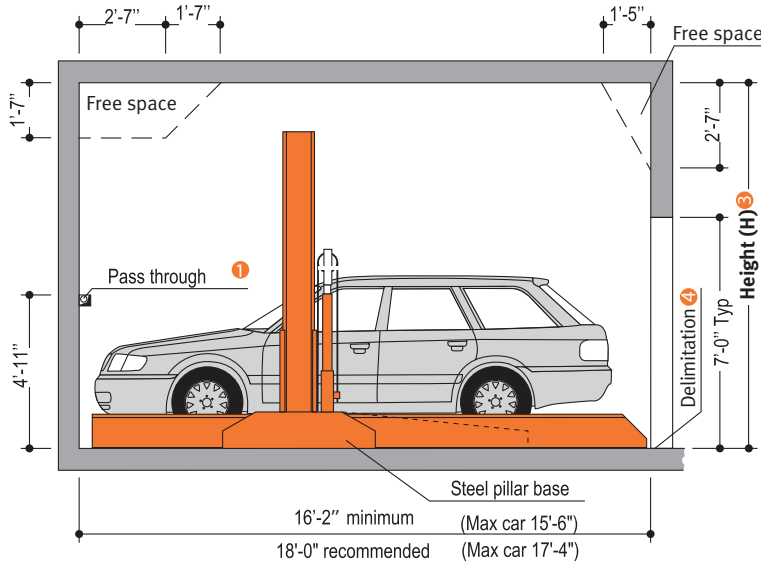

Garage with door in front of the parking machine.

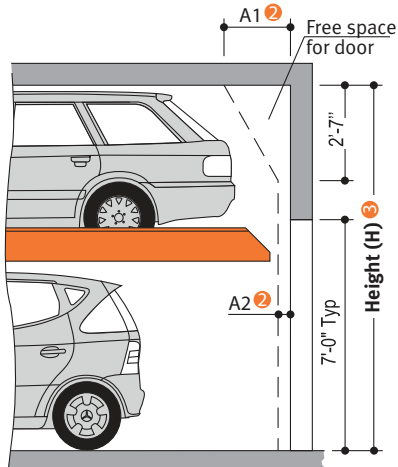

- 1 4" x 4" pass through at walls
- 2 Dimensions A1, and A2 must be coordinated with the door supplier.
- 3 If the total height is greater, the max. vehicle height for the upper parking space increases accordingly.
- 4 4" wide yellow stripe recommended at edge of machine (Buyer)
- 5 Standard is 4,400lbs; 5,600lbs is available

Product Data
Singlevario
G61



Loadable
up to 5,600 lb
A system for
any height

DIMENSIONS

All space requirements are minimum finished dimensions. Tolerances are plus 1 inch & minus zero.

TYPE	H	DH **
2061-160	10'-6"	5'-3"
2061-170*	10'-10"	5'-7"
2061-180	11'-2"	5'-11"
2061-190	11'-6"	6'-3"
2061-200	11'-10"	6'-7"
2061-210	12'-2"	6'-11"

* = standard type

** = without car

SUITABLE FOR:

Standard passenger car, station wagon/
van. Height and length according
to contour.

CAR HEIGHT

TYPE	H	UPPER	LOWER
2061-160	10'-6"	4'-11"	4'-11"
2061-170	10'-10"	4'-11"	5'-3"
2061-180	11'-2"	4'-11"	5'-7"
2061-190	11'-6"	4'-11"	5'-11"
2061-200	11'-10"	4'-11"	6'-3"
2061-210	12'-2"	4'-11"	6'-7"

* = standard type

WIDTH 6'-3"

WEIGHT Max. 4400/5600 LBS

WHEEL LOAD Max. 1100/1375 LBS

Standard passenger car

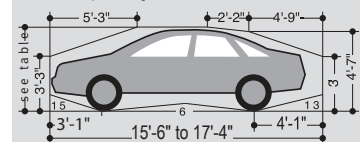

Standard station wagon/Van/SUV

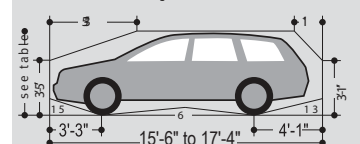

Standard passenger cars are vehicles
without any sports options such as
spoilers, low-profile tires etc.

KLAUS
multiparking

KLAUS MULTIPARKING INC
3652A CHESTNUT STREET
LAFAYETTE, CA 94549

Phone 925-284-2092

Fax 925-284-3365

WEB parklift.com

PARKING LIFT SPECIFICATIONS

Dividing walls

Single Platform (EB)



Useable platform width	B1
7'-6" (230cm) *	8'-7"
7'-10" (240cm)	8'-11"
8'-2" (250cm)	9'-3"
8'-6" (260cm)	9'-7"
8'-10" (270cm)	9'-10"

Double arrangement (2 x EB)

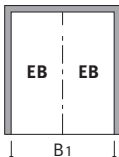

Useable platform width	B1
7'-6" (230cm) *	17'-1"
7'-10" (240cm)	17'-9"
8'-2" (250cm)	18'-5"
8'-6" (260cm)	19'-1"
8'-10" (270cm)	19'-9"

Triple arrangement (3 x EB)

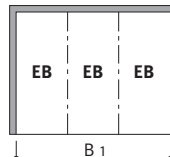

Useable platform width	B1
7'-6" (230cm) *	25'-8"
7'-10" (240cm)	26'-7"
8'-2" (250cm)	27'-3"
8'-6" (260cm)	28'-7"
8'-10" (270cm)	29'-7"

Drive aisle in accordance with local regulations, 24 ft recommended

Columns in system zone

Single Platform (EB)

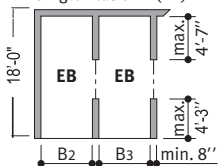

Useable platform width	B2	B3
7'-6" (230cm) *	8'-5"	8'-3"
7'-10" (240cm)	8'-9"	8'-7"
8'-2" (250cm)	9'-1"	8'-11"
8'-6" (260cm)	9'-5"	9'-3"
8'-10" (270cm)	9'-9"	9'-7"

Double arrangement (2 x EB)

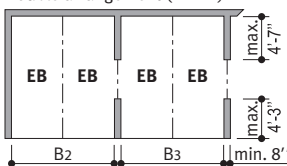

Useable platform width	B2	B3
7'-6" (230cm) *	16'-11"	16'-9"
7'-10" (240cm)	17'-7"	17'-5"
8'-2" (250cm)	18'-3"	18'-1"
8'-6" (260cm)	18'-11"	18'-9"
8'-10" (270cm)	19'-7"	19'-5"

Triple arrangement (3 x EB)

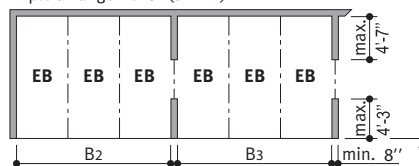

Useable platform width	B2	B3
7'-6" (230cm) *	25'-6"	25'-4"
7'-10" (240cm)	26'-5"	26'-3"
8'-2" (250cm)	27'-5"	26'-11"
8'-6" (260cm)	28'-5"	27'-11"
8'-10" (270cm)	29'-5"	29'-3"

Drive aisle in accordance with local regulations, 24 ft recommended

Columns outside of system zone

Single Platform (EB)

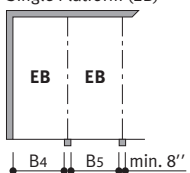

Useable platform width	B4	B5
7'-6" (230cm) *	8'-2"	7'-10"
7'-10" (240cm)	8'-6"	8'-2"
8'-2" (250cm)	8'-10"	8'-6"
8'-6" (260cm)	9'-2"	8'-10"
8'-10" (270cm)	9'-6"	9'-2"

Double arrangement (2 x EB)

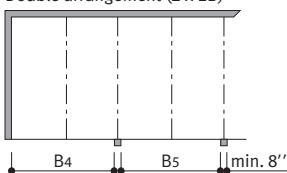

Useable platform width	B4	B5
7'-6" (230cm) *	16'-9"	16'-5"
7'-10" (240cm)	17'-5"	17'-1"
8'-2" (250cm)	18'-0"	17'-8"
8'-6" (260cm)	18'-8"	18'-4"
8'-10" (270cm)	19'-4"	19'-0"

Triple arrangement (3 x EB)

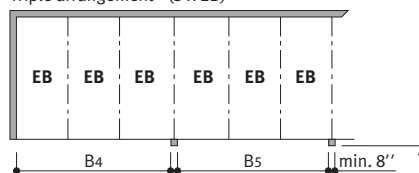

Useable platform width	B4	B5
7'-6" (230cm) *	25'-3"	24'-11"
7'-10" (240cm)	26'-3"	25'-11"
8'-2" (250cm)	26'-11"	26'-7"
8'-6" (260cm)	27'-10"	27'-3"
8'-10" (270cm)	29'-2"	27'-10"

Drive aisle in accordance with local regulations, 24 ft recommended

Single platform (EB)

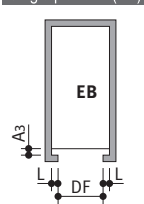

Useable platform width	Door entrance width DF	L	S
7'-6" (230cm) *	7'-9"	5"	10"
7'-10" (240cm)	7'-10"	5"	10"
8'-2" (250cm)	8'-2"	6"	12"
8'-6" (260cm)	8'-6"	6"	12"
8'-10" (270cm)	8'-10"	6"	12"

* = Standard width (parking space width of 7'-6")

Double arrangement (2 x EB)

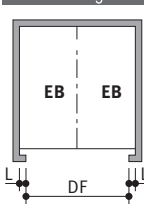

Useable platform width	Door entrance width DF	L	S
7'-6" (230cm) *	15'-7"	9"	1'-6"
7'-10" (240cm)	16'-5"	8"	1'-4"
8'-2" (250cm)	17'-1"	8"	1'-4"
8'-6" (260cm)	17'-8"	8"	1'-4"
8'-10" (270cm)	18'-4"	8"	1'-4"

Drive aisle in accordance with local regulations, 24 ft recommended

A₃ = seat-engaging surface (dimensions require coordination with door supplier.)

Allround door dimensions require coordination between door supplier and local agency of Klaus Multiparking.

NOTE



End parking spaces are generally more difficult to drive into. Therefore we recommend wider platforms for end parking spaces. Parking on standard width platforms with larger vehicles may make getting into and out of the vehicle difficult. This depends on type of vehicle, approach and above all on the drivers skill. Use the widest platform possible.

PARKING LIFT SPECIFICATIONS

APPROACH

! The illustrated maximum approach angles must not be exceeded. Exceeding these slopes will cause maneuvering problems and will restrict car sizes on the parking system.

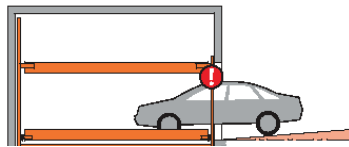

Maximum descending slope of 4%

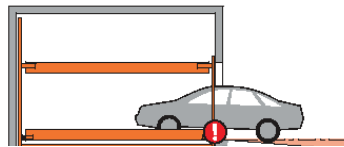

Maximum ascending slope of 14%

ELECTRICAL INSTALLATION

Suitable electrical supply to the main switch and the control wire line must be provided by the customer during installation. One motor control box is suitable for controlling a chain of up to ten lifts.

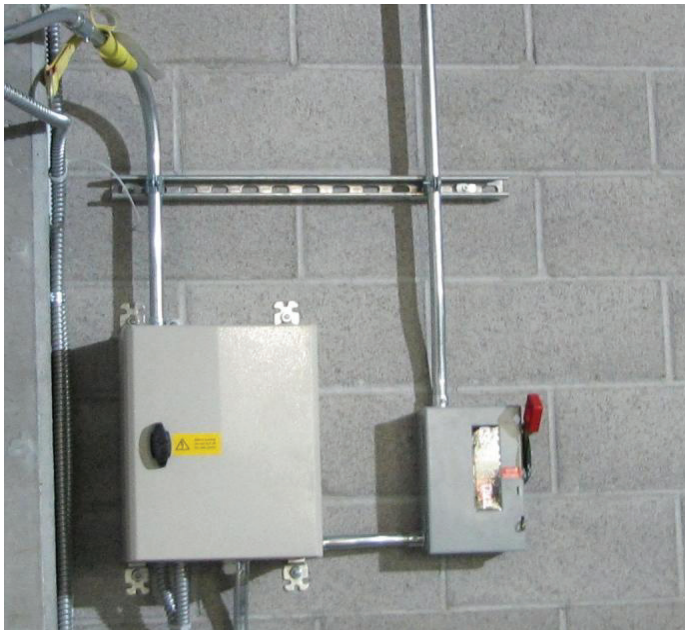

LONGITUDINAL FREE SPACE

Free space for longitudinal and vertical ducts (e.g. ventilation). This free space is valid for cars which drive in forward with drivers door on left side

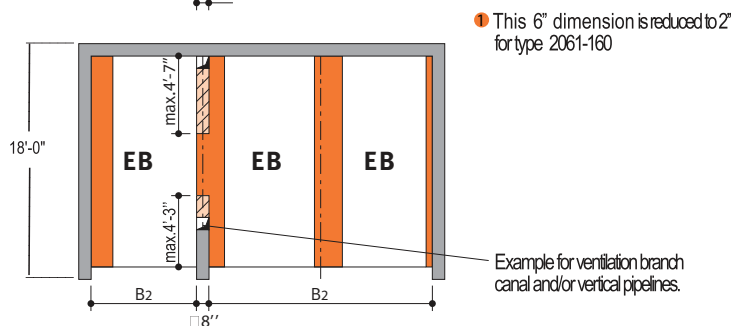
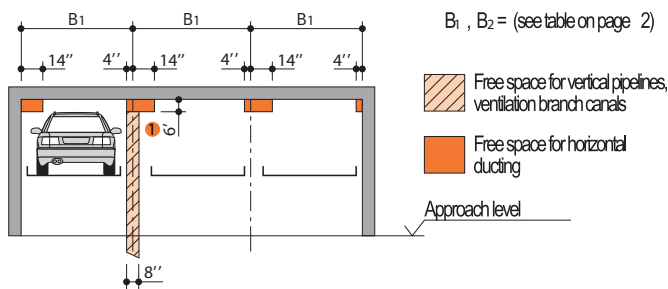

PARKING LIFT SPECIFICATIONS

FUNCTION



PLEASE NOTE: THE LOWER CAR MUST BE MOVED BY A PERSON TO LOWER THE UPPER CAR

SEISMIC BRACING IS DONE AT THE TOP OF THE TOWER

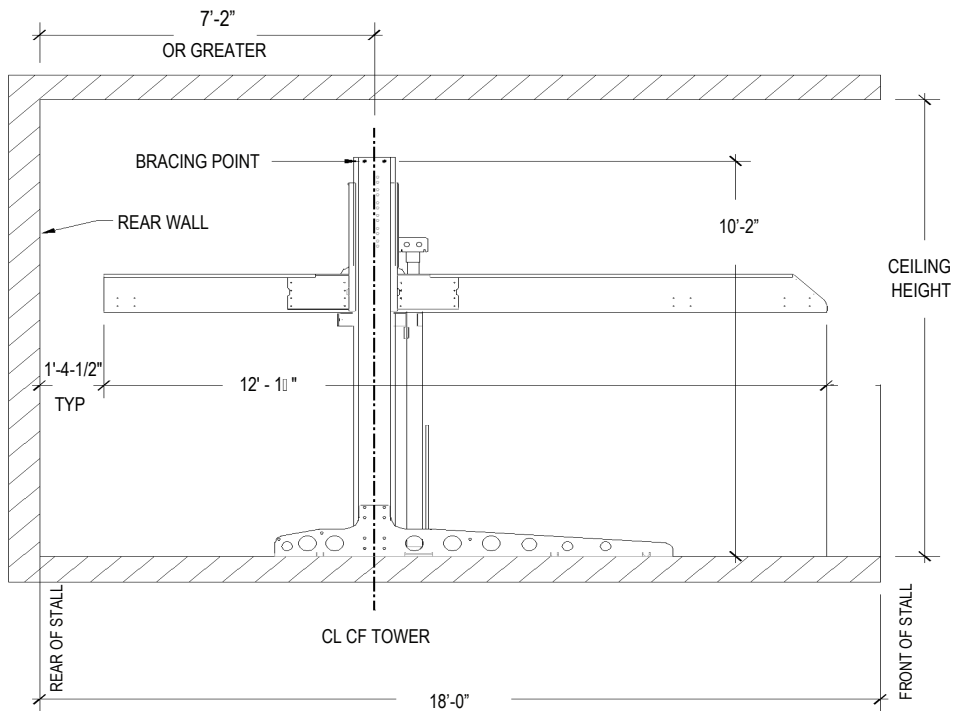

PARKING LIFT SPECIFICATIONS

GENERAL DESCRIPTION

The Klaus SingleVario G61 provides dependent access to all cars parked on the system. The lower car must be moved manually to allow the upper car to come down spaces are arranged on two levels, with the lower level parked on the garage slab. Each individual parking bay must be accessible from the drive aisle. The drive aisle must comply with local regulations, but is typically 24' wide. The parking spaces are arranged on two levels, with the lower level parked on the garage slab.

TECHNICAL DATA

RANGE OF APPLICATION

This parking system is suitable for self parking by owners, renters, regular employees or anyone that can be trained on the system. The public may not park this system without a valet.

ENVIRONMENTAL CONDITIONS

Environmental conditions for the systems: Temperature range 14° to 104°F. The system may be installed indoors or outdoors. If lifting times are specified, they refer to an environmental temperature of 72°F and with system setup directly next to the hydraulic unit. At lower temperatures or with longer hydraulic lines, these times increase.

CONTROL SYSTEMS

The machine comes standard with 2 keys per parking space. The key is inserted in user control and turned one way to raise the platform and the other way to lower it. The key is spring loaded and the machine will stop if the operator lets go of the key. A remote control is not available for this machine (due to safety considerations).

SPRINKLER SYSTEM

The sprinklers may be mounted at the rear of each level and between machines if needed.

ELECTRICAL REQUIREMENTS AND HYDRAULIC UNIT

The hydraulic power unit is normally installed against the back wall on a metal motor and hydraulic oil reservoir in one unit. It consists of an electric motor, hydraulic motor and hydraulic oil reservoir in one unit. The hydraulic oil is biodegradable and environmentally friendly. The electric motor can be supplied in a 208 volt three phase (preferred) or a 240 volt single phase. Both types require a 30 amp circuit. One hydraulic power unit can run up to 25 lifts. KLAUS will provide the motor and motor controller. BUYER to provide a fused disconnect. BUYER to provide conduit and wiring; a.) from fused disconnect (supplied by BUYER) to motor controller (supplied by KLAUS); b.) from motor controller to motor (supplied by KLAUS). KLAUS to furnish and install control wiring.

CORROSION PROTECTION

The platforms should be cleaned annually to maximize their life. The platforms are galvanized and the steel framing members are powder coated.

SERVICE

To maintain safe and reliable operation of the machine, it must be serviced twice per year if located outside in the weather or a minimum of once per year if located inside a garage.

WARRANTY

To machine has a complete one year parts and labor warranty. Klaus provides extended warranties.

SOUND CONTROL

Numerous sound control features are standard. The hydraulic power unit is mounted on rubber pads. Steel hydraulic lines are mounted with rubber pipe supports. A rubber hose isolates the power unit from the steel hydraulic lines.

Sound tests at the front of the machine show about 67dB to 69dB (A weighting) noise levels (similar to a garage door). An optional power pack cover can reduce the noise to 56dB to 58dB.

In multifamily podium construction, normally no special construction for sound is performed. other sound issues. For residential or wood frame construction, placement of the power unit is critical. Klaus designers will assist with power unit placement and other sound issues.

STRUCTURAL

The machine has steel framing and is anchor bolted to the floor slab with wedge anchors. The framework consists of steel columns and cross members. Galvanized decking spans the framing left to right and creates a liquid tight deck which will not allow drips onto the lower vehicle. In addition to anchor bolts to the floor slab, the machine must be braced in the left / right direction especially for seismic loads.

This can be done in one of two ways:

- 1.) One of the machine columns can be braced against a wall or column.
- 2.) Additional angles can be added at the floor level to provide additional support. Please see the G61 bracing details drawing and the Merkle Engineers report for more details.

The lifting mechanism for the upper platform consists of hydraulic cylinder which raises one side of the platform. The other side of the platform is raised via a chain. There are safety switches that stop the machine in the event the chain goes loose for any reason.

SCOPE OF WORK CLARIFICATIONS

1. The garage floor and surrounding walls, columns and beams to provide support for the machine are provided by the customer.
2. All drainage is provided by the customer.
3. General lighting in the garage is provided by the customer. Extra lighting may be needed to light the area below the platform.
4. Klaus will supply design assistance and will confirm in writing that the proposed machine will fit in the space provided.
5. Klaus will prepare shop drawings showing the location of all components.
6. In the event that there is no rear wall, Klaus will provide a stand for the electrical junction box. No fencing is required.
7. The customer must provide a 30 amp 3 phase 208V (or 240V single phase) circuit and fused disconnect for each machine group and power must be available before installation begins.
8. Klaus provides all control wiring.
9. All space numbering and striping is to be provided by the customer.

WE RESERVE THE RIGHT TO CHANGE THIS SPECIFICATION WITHOUT FURTHER NOTICE

The Klaus company reserves the right in the course of technical progress to use newer or other technologies, systems, processes, procedures or standards in the fulfillment of their obligations other than those originally offered provided the customer derives no disadvantage from their doing so.

ZERTIFIKAT ◆ CERTIFICATE ◆ 認証証書 ◆ CERTIFICADO ◆ CERTIFICAT



Industrie Service

Certificate concerning the examination of conformity

Certificate no.: KP 005

Notified body: TÜV SÜD Industrie Service GmbH
Westendstr. 199
80686 München – Germany

**Applicant/Manufacturer
Certificate holder:** Klaus Multiparking GmbH
Hermann-Krumm-Str. 2
88319 Aitrach – Germany

Date of application: 2009-09-03

Product: Parking system

Type: SingleVario 2061

Test laboratory: TÜV SÜD Industrie Service GmbH
Prüflaboratorium für Produkte der Fördertechnik
Prüfbereich Maschinen der Fördertechnik
Gottlieb-Daimler-Str. 7
70794 Filderstadt – Germany

**Date and
number of the test report/
mark of conformity:** 2009-12-04
TÜ SW-08-226 DG

Test specifications: 2006 / 42 / EC
DIN EN 14010

Valid from: 2009-12-29
Valid until: 2014-09-30

Result: The equipment fulfills the safety requirements of the EC-Directive for the scope of application stated in the test report.

Note: This certificate is based on state-of-the-art-technology which is documented by the harmonized standards that are valid at the moment.
If these norms are changed or completed or if the state-of-the-art-technology is further developed, a renewal of the certificate might be necessary.

Date of issue: 2009-12-04

Certification body for lifts and safety components

S. Melzer

Siegfried Melzer

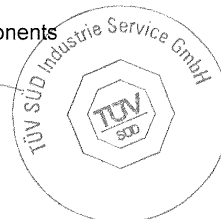

TUV®