

Middlefield Park Master Plan

OCTOBER 2022

Project team

PROJECT APPLICANT / PROPERTY OWNER

GOOGLE

APPLICANT REPRESENTATIVE

LENDLEASE SILICON VALLEY DEVELOPMENT LLC

DESIGN + CONSULTANT TEAM

SERA ARCHITECTS: Master Planning

HASELL: Urban Design

CMG: Landscape Design

KRISTEN HALL CITY DESIGN: Planning

SHERWOOD: Civil and Infrastructure

H.T. HARVEY & ASSOCIATES: Ecology

SAN FRANCISCO ESTUARY INSTITUTE (SFEI): Ecology

ARUP: Transportation and District Systems

FEHR & PEERS: Transportation

ALLEN MATKINS: Land Use and Entitlements

EPS: Fiscal Impact Analysis

HORTSCIENCE: Arborist Report

Table of Contents

1. INTRODUCTION	1	5.5	Jobs-Housing Linkage Plan	49	7.6	Transit network and stops	103	
1.1	Document guide	2	5.6	Affordable housing	50	7.7	Street network	104
1.2	Terminology	3	5.7	Bonus floor area ratio	50	7.8	Street design	108
1.3	Location summary	4	6. OPEN SPACE	53	7.9	Parking strategy	112	
2. DESIGN CONCEPT	5	6.1	Open space approach	54	7.10	Curb management plan	115	
2.1	Vision for a connected community	6	6.2	Open space network	58	8. BUILDINGS	117	
2.2	Community process	8	6.3	Open space programming	59	8.1	Architectural vision	118
2.3	Delivering Precise Plan guiding principles	9	6.4	Green connections	60	8.2	Built form approach	120
2.4	Design framework	12	6.5	Ecological function and experience	61	8.3	EWPP Building Design Standards	122
3. PROGRAM SUMMARY	25	6.6	Canopy phasing	64	8.4	Solar studies	129	
3.1	Program summary	27	6.7	Planting	66	8.5	EWPP Building Design Guidelines	130
4. EXISTING CONDITIONS	29	6.8	Plant palettes	68	8.6	Site planning flexibility	137	
4.1	Site context	30	6.9	Land and easement dedication	72	8.7	Garage strategy	139
4.2	Open space and ecological context	33	6.10	City parks	73	9. UTILITY INFRASTRUCTURE	143	
4.3	Circulation and mobility context	34	6.11	Introduction to Ellis Park	74	9.1	Infrastructure at a district scale	144
4.4	Relationship to other regulatory documents	37	6.12	Ellis Park and Ellis Plaza scale comparisons	79	9.2	Thermal energy	147
5. LAND USE	39	6.13	Ellis Park design	82	9.3	Power	147	
5.1	Land use	40	7. CIRCULATION AND MOBILITY	93	9.4	Water	148	
5.2	Block structure	42	7.1	District approach	94	10. PROJECT BENEFITS	149	
5.3	Development program	43	7.2	Mobility futures	96	10.1	Community Benefits	150
5.4	Ground floor uses	46	7.3	A multimodal network	97	10.2	Fiscal impact	150
			7.4	Pedestrian network	98			
			7.5	Bicycle network	101			

Please see the accompanying Implementation Plan document for supporting materials.

Tables and Figures

Figure 1.1.1	Middlefield Park Implementation Plan	2	Figure 3.1.2	Program summary	27	Figure 6.1.2	Open space key plan	55
Table 1.3.1	Site	4	Figure 4.1.1	Existing area map	30	Figure 6.1.3	Open space concept	55
Table 1.3.2	General Plan/Zoning framework	4	Figure 4.1.2	665 Clyde Avenue	31	Figure 6.2.1	Open space plan	58
Figure 1.3.3	Site parcel map	4	Figure 4.1.3	Photos of existing site conditions	32	Figure 6.3.1	Key open spaces	59
Figure 2.1.1	Google's Principles of Place	6	Figure 4.2.1	Existing planting and hardscape	33	Figure 6.3.2	Potential programming	59
Figure 2.1.2	Middlefield Park Master Plan Principles	6	Figure 4.3.1	Street Typologies per EWPP	35	Figure 6.4.1	Green connections diagram	60
Figure 2.1.3	Components of place	7	Figure 4.3.2	Existing transit network	36	Figure 6.5.1	Ecological connections	61
Figure 2.2.1	Illustrative rendering of open space character	8	Figure 5.1.1	Comparative site coverage: Middlefield Park today and transformed tomorrow	40	Figure 6.5.2	Proposed tree species composition	61
Figure 2.4.1	Middlefield Park location between downtowns and VTA stations	12	Figure 5.1.2	Existing and future land use	40	Figure 6.5.3	Ecological typologies	62
Figure 2.4.2	Middlefield Park location within the East Whisman Precise Plan boundary	13	Figure 5.1.3	Existing general land use	41	Figure 6.5.4	Contribution of East Whisman to ecological context	62
Figure 2.4.3	Middlefield Park land use framework	15	Figure 5.1.4	Land use plan	41	Figure 6.6.1	Canopy phasing diagrams	64
Figure 2.4.4	Illustrative rendering of a landscaped pathway	16	Figure 5.2.1	Transforming the East Whisman block structure	42	Figure 6.7.1	Planting design precedent images	67
Figure 2.4.5	Illustrative rendering of Ellis Plaza	16	Table 5.3.1	Proposed unit count	43	Figure 6.8.1	Ecological typologies	68
Figure 2.4.6	Range of open space experiences	17	Table 5.3.2	Proposed Active Uses	43	Figure 6.8.2	Street trees	68
Figure 2.4.7	Middlefield Park open space framework	17	Table 5.3.3	Proposed open space areas	44	Figure 6.8.3	White alder mix	69
Figure 2.4.8	Examples of human-scale building design	18	Table 5.3.4	Proposed office area	45	Figure 6.8.4	Oak mix	69
Figure 2.4.9	Bird's eye view of massing concept	19	Figure 5.4.1	Conceptual ground floor activation strategy	47	Figure 6.8.5	Canyon mix	70
Figure 2.4.10	Physical and digital strategies for supporting sustainable mobility	21	Figure 5.4.2	Examples of neighborhood-serving uses	48	Figure 6.8.6	High canopy mix	70
Figure 2.4.11	Circulation and mobility framework	21	Figure 5.5.1	Jobs-Housing Linkage phasing	49	Figure 6.8.7	California sycamore mix	71
Figure 2.4.12	Indicative resource management strategies	23	Figure 5.5.2	Jobs-Housing Linkage plan	49	Figure 6.8.8	Pollinator meadow mix	71
Figure 2.4.13	District systems precedent	23	Figure 5.7.1	EWPP Bonus FAR Tiers	51	Table 6.9.1	Public access and dedication	72
Figure 2.4.14	Examples of proposed sustainable infrastructure improvements	23	Table 5.7.2	Development Reserve entitlement	52	Figure 6.9.2	Public park dedication and easements	72
Figure 2.4.15	CLT precedent	23	Table 5.7.3	Proposed office FAR	52	Figure 6.10.1	Landscaped multi-use path vignette	73
Table 3.1.1	Middlefield Park program summary	26	Table 5.7.4	Proposed residential/mixed-use FAR	52	Figure 6.11.1	Ellis Plaza + Ellis Walk = Ellis Park	74
			Figure 5.7.5	Middlefield Park FAR by character area	52	Figure 6.11.2	Character gradient from vivid arrival to immersive garden	74
			Figure 6.1.1	Open space character images	54			

Figure 6.11.3	Complementing nearby parks and park elements	75	Table 7.1.2	Googlers in Mountain View today	95	Figure 8.2.3	Open space	121
Table 6.11.4	City of Mountain View demographics	76	Figure 7.3.1	Middlefield Park multimodal network	97	Figure 8.2.4	Built form	121
Table 6.11.5	Outreach organizations	78	Figure 7.4.1	Middlefield Park AM peak-hour pedestrian flow	98	Figure 8.3.1	Maximum building height	123
Table 6.11.6	Proposed program areas	78	Figure 7.4.2	Proposed pedestrian network improvements	99	Table 8.3.2	Building heights summary	124
Figure 6.12.1	1-acre Ellis Plaza scale comparisons	79	Figure 7.4.3	Residential Paseos	100	Figure 8.3.3	Maximum average street wall height standards	125
Figure 6.12.2	Design precedent photos of Bay Meadows	80	Figure 7.4.4	Non-residential Paseo	100	Figure 8.3.4	Maximum average street wall height standards in axon	126
Figure 6.12.3	Ellis Park scale comparison of Bay Meadows	80	Figure 7.5.1	Proposed bike network improvements	101	Figure 8.3.5	Setback standards applied to the Master Plan	126
Figure 6.12.4	Design precedent photos of Klyde Warren Park	81	Table 7.5.2	Bicycle parking per land use	102	Figure 8.3.6	Indicative development envelopes	127
Figure 6.12.5	Ellis Park scale comparison of Klyde Warren Park	81	Figure 7.7.1	Street network typology	105	Figure 8.3.7	Visual studies	128
Figure 6.13.1	Open space design character images	82	Figure 7.7.2	Truck access and routing	106	Figure 8.4.1	Solar studies	129
Figure 6.13.2	Ellis Park plan	83	Figure 7.7.3	EVA network	107	Figure 8.5.1	Examples of corner buildings and Key Corner architectural treatments	130
Figure 6.13.3	Ellis Park programming plan	84	Figure 7.8.1	Typical section - Middlefield Road	109	Figure 8.5.2	Key Corner design and corner buildings	131
Figure 6.13.4	Ellis Plaza vignette	85	Figure 7.8.2	Typical section - Ellis Street	109	Figure 8.5.3	Key Corner precedents	131
Figure 6.13.5	Ellis Plaza section view looking north	86	Figure 7.8.3	SR 237 frontage road with two-way cycle track	109	Figure 8.5.4	Building relationship to open space	132
Figure 6.13.6	Ellis Plaza plan enlargement	86	Figure 7.8.4	Typical section - Logue, Maude, and Clyde Avenues	110	Figure 8.5.5	Examples of residential building ground floor relationships to open space	133
Figure 6.13.7	Precedent images	86	Figure 7.8.5	Typical section - Service Streets	111	Figure 8.5.6	Examples of residential building ground floor relationships to open space	133
Figure 6.13.8	Ellis walk at Residential 2 vignette	87	Figure 7.9.1	Examples of parking and car-sharing strategies	113	Figure 8.5.7	Examples of building relationship to open space	133
Figure 6.13.9	Ellis walk at Residential 2 plan	88	Table 7.9.2	Proposed Off-Street parking ratios	113	Figure 8.5.8	Examples of building differentiation	134
Figure 6.13.10	Ellis walk at Residential 2 section, view looking north	88	Table 7.9.3	Parking locations and capacity	113	Figure 8.5.9	Building massing breaks	135
Figure 6.13.11	Precedent images	88	Figure 7.9.4	Approximate AM parking flows and distribution	114	Figure 8.5.10	Example building massing breaks	135
Figure 6.13.12	Ellis Walk at Office 1 vignette	89	Figure 7.9.5	Approximate PM parking flows and distribution	114	Figure 8.5.11	Examples of office/R&D buildings where street frontage lengths are limited to 300 feet	136
Figure 6.13.13	Ellis Walk at Office 1 plan	90	Figure 7.10.1	Curb management plan	115	Figure 8.5.12	Examples of building massing breaks	136
Figure 6.13.14	Ellis Walk section at Office 1 fit lot and bridge	90	Table 7.10.2	Expected loading space for private transit	116			
Figure 6.13.15	Precedent images	90	Figure 8.1.1	Building design precedents	119			
Table 7.1.1	Citywide mode share in Mountain View	95	Figure 8.2.1	Height zones	120			
			Figure 8.2.2	Development blocks	120			

Figure 8.6.1	Example options of site planning for residential and office buildings	138
Figure 8.7.1	Proposed P2 garage section	140
Figure 8.7.2	Garage, Site Frameworks	140
Figure 8.7.3	Garage structure goals	141
Figure 8.7.4	Garage facade treatment precedents	142
Figure 8.7.5	District garage parking strategy	142
Figure 9.1.1	Alignment with City of Mountain View sustainability goals	144
Figure 9.1.2	Overview of District Systems in a mixed-use development	145
Figure 9.1.3	Potential district system corridor and CUP location	146
Figure 9.3.1	East Carolina Central Utility Plant	147
Figure 9.3.2	Barangaroo Plantroom (Sydney, Australia)	148
Figure 9.4.1	Water balance concept	148



1. INTRODUCTION

“The East Whisman Area advances as a sustainable, transit-oriented residential neighborhood and employment center with an increased diversity of land uses, multiple mobility choices, numerous high-quality open spaces, vibrant local and local serving businesses, and housing options for all incomes and stages of life.”

— East Whisman Precise Plan

1.1 Document guide

A master plan is required to fulfill the criteria set forth by the City of Mountain View (CMV) for the site that includes the Neighborhood Park described in the East Whisman Precise Plan. The Middlefield Park Master Plan describes the vision and proposal for re-development of this area around the Valley Transportation Authority's (VTA) Middlefield Station, and is compliant with all East Whisman Precise Plan requirements for a Neighborhood Park Master Plan, including submittal requirements in Precise Plan Section 6.3.2.1.b.

This project also requires a master plan under the East Whisman Precise Plan, as the development proposes district parking, net new commercial square footage qualified through the Jobs-Housing Linkage Program, phased construction, and

a site that spans multiple character areas within the Precise Plan.

The Middlefield Park Master Plan document starts with the design vision and concepts, a summary of the development program, and a description of existing conditions. It then lays out strategies for land use, open space and ecological communities, circulation and mobility, buildings and massing, utility infrastructure, and implementation.

The Implementation Plan document contains additional information demonstrating compliance with the East Whisman Precise Plan, Mountain View Municipal Code, and other key information for the implementation of the Master Plan.

Within the Implementation Plan, the Urban Design Objectives provides additional detail and direction to future

development teams to apply the Master Plan vision at the individual building level. The section includes detailed guidance on implementing the placemaking vision, open space character, and architectural character through examples of ground floor frontages, street walls and key corners and conceptual block-scale elevations. Through imagery, diagrams and text, future designers are provided a rich and diverse range of inspirations to fulfill the placemaking ambitions of the Middlefield Park Master Plan.

Companion documents and Approvals

Supporting the Middlefield Park Master Plan are the following companion documents and approvals, including:

- Project Environmental Impact Report;
- Development Agreement;

- Vesting Tentative Map and subdivision conditions of approval;
- Vacation of a portion of Logue Avenue;
- Park Land credit for a Privately Owned, Publicly Accessible (POPA) Open Space;
- Master Plan Conditions of Approval.

Implementation Plan

This document contains more detailed content for implementing the Master Plan:

- Phasing Plan;
- Precise Plan Compliance;
- POPA Compliance;
- Urban Design Objectives;
- Master Plan Level Arborist Report;
- Planting Design;

- Tree Framework Plan;
- Affordable Housing Plan;
- Fire Access;
- Logue Avenue Diagrams;
- Transportation Demand Management Plan;
- District Systems Concept Plan;
- Review and Approval Framework.



Figure 1.1.1 Middlefield Park Implementation Plan

1.2 Terminology

East Whisman Precise Plan (EWPP)

This document presents the City's vision, guiding principles, plan strategies, and development standards for the East Whisman Precise Plan area ("Precise Plan" or "EWPP"). The EWPP was adopted by the City of Mountain View on November 5, 2019.

Middlefield Park Master Plan (MPMP)

"Middlefield Park" describes a ± 40 acre area surrounding VTA Middlefield Station; and the "Middlefield Park Master Plan" (MPMP) refers to Google's master plan proposal for this area. Throughout this document, "the Project" is also used to describe the Middlefield Park Master Plan. Elements of the Project are anticipated to be funded and delivered by multiple parties – including but not limited to Google, Lendlease, or other private entities or landowners, as well as the City of Mountain View or other public agencies or jurisdictions – in compliance with the Precise Plan or other documents, ordinances, statutes, etc., as applicable.

Document notes

- **Figures:** All figures in this document are provided for illustrative purposes only. The conceptual renderings used throughout the Middlefield Park Master Plan, and other supporting documents, are representative of architectural design concepts or design intent for new mixed-use and office buildings. They are provided to give a general impression of the buildings' scale and massing relative to the public open spaces and streetscapes that their ground floor uses' help to frame and activate. Building and site-specific architectural designs will be provided with each phase of permit entitlements.
- **Measurement:** Unless otherwise noted, all area measurements throughout this document indicate gross square feet (GSF).
- **Residential units:** Total units shown are targets within the range provided, are

represented in total as minimums and maximums, and are subject to further refinement in future permit entitlements.

- **Office Square Footage:** Total office square footages are targets, and are represented in total as minimums and maximums, and are subject to further refinement in future permit entitlements.
- **Active Uses:** Total active use square footages are also targets, and are represented in total as minimums and maximums, and are subject to further refinement in future permit entitlements. Active uses collectively encompass all community, civic, retail and neighborhood commercial uses currently contemplated in the plan area.
- **District Systems:** District Systems are contemplated as a design option within the framework of this Master Plan and are at Google's full discretion whether or not to pursue.

- **Parks:** New parks have been given placeholder names, inspired by the local context, to be used during the planning process. Final names of publicly dedicated parkland shall be determined by the City of Mountain View. Privately owned accessible public spaces (POPAs) shall be named by the land owner with approval by the City.

- **Parcel Names:** The naming of each residential/mixed-use location directly pairs with the parcelization in the Tentative Map (e.g. R1 is Parcel R1). For each public park, the Middlefield Park Master Plan and Tentative Map names align with the following parcels:

Bridge Open Space at Ellis
Street: Parcel Park 1

Bridge Open Space at Logue
Avenue: Parcel Park 2

Maude Park: Parcel Park 3

Gateway Park: Parcel Park 4.

1.3 Location summary

Table 1.3.1 Site	
Address/APN:	440 Logue Avenue 160-58-001
	500 East Middlefield Road 160-58-016
	401 Ellis Street 160-58-017
	433 Clyde Avenue 160-57-004
	485 Clyde Avenue 160-57-006
	495 Clyde Avenue 160-57-007
	500, 510, 520, 530 Logue Avenue, 500-506, 510, 516, 520, 526 Clyde Avenue 160-57-008
	440 – 450 Clyde Avenue 160-57-009
	420 Clyde Avenue 160-57-010
	880 Maude Avenue 160-57-011
	800, 830, 840-850 Maude Avenue 160-57-012
	441 Logue Avenue 160-57-013
	885 – 889 Maude Avenue 160-59-005
	891 Maude Avenue 160-59-006
Site Area:	39.88 acres/1,736,969 sf

Table 1.3.2 General Plan/Zoning framework	
General Plan:	East Whisman Mixed-Use High Intensity Office
Zoning Map:	Planned Community/Precise Plan
East Whisman Precise Plan:	Mixed-Use Character Area <ul style="list-style-type: none"> • High Intensity Sub-Character Area • Medium Intensity Sub-Character Area Employment Character Area <ul style="list-style-type: none"> • Low Intensity Sub-Character Area



Figure 1.3.3 Site parcel map

2. DESIGN CONCEPT

The Middlefield Park Master Plan builds on the East Whisman Precise Plan to envision a transit-oriented, mixed-use community at VTA Middlefield Station, complete with stores, services, and restaurants for residents, neighbors, and workers, as well as a range of plazas and open spaces.

2.1 Vision for a connected community

The vision for a new community at Middlefield Park is conceived from Google's Principles of Place, which inform the Master Plan Principles. These Principles guide the elements and implementation of this proposal.

Google's Principles of Place

Community

Places are about people and the connections between them. We want to contribute to vibrant places that promote well-being, inclusion and interconnectivity.



Innovation

Have a healthy disregard for the impossible. We design for adaptability and flexibility.

Nature

The wellbeing of people depends on the health of the planet. We aspire to build spaces and places that are resilient and circular, connect people to nature, and help us conserve resources and reduce waste.

Economics

We invest in bold ideas that create replicable solutions for a better future. We want our designs to give something back to the world that wasn't already there.

Figure 2.1.1 Google's Principles of Place

Middlefield Park Master Plan Principles



Shared

Activating a range of shared places to create an authentic and vibrant community.



Active + Connected

Creating a setting that increases connectivity and promotes health and wellbeing through active mobility.



In Nature

Healing this area through ecology, creating a meaningful connection to place.



Diverse + Inclusive

Attracting people from diverse backgrounds, offering a range of choice in housing and recreation.

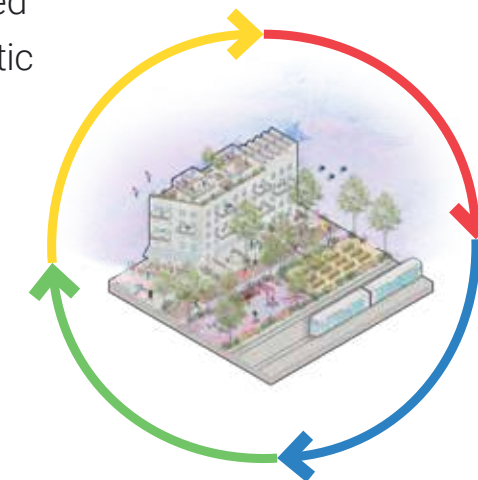

Figure 2.1.2 Middlefield Park Master Plan Principles

Connections are at the core of Middlefield Park: physical connections to invite the surrounding communities to access transit and new parks, and social connections for future residents, employees, and visitors to form new communities and robust social bonds. A mix of uses will bring life and diversity to what is currently a single-use office area, in the form of a complete neighborhood – with residents and workers filling the streets, supporting local businesses, and enjoying the health and well-being offerings of parks all throughout the week.

The components of place

- **Balanced live and work:** Proportional new housing units for every 1000 gross square feet of net new office;
- **Generous open space:** Over 12 acres of open space for the

- broader East Whisman and Mountain View community;
- **Active VTA transit hub with retail:** Including market and >20,000 square feet of neighborhood services around a new station plaza;
- **Thriving natural canopy:** Aim to plant and preserve trees whose canopy provides shade over the site, and are beginning to restore the native ecology;
- **Connected bike/pedestrian network:** 1.5 miles of safe separated bike/ped paths linking to over 500 miles of the Bay Trail;
- **Sustainable district systems:** Shared infrastructure used to target net-zero carbon and a holistic, healthy place;
- **Inclusive public programming:** To connect a diverse community with shared experiences.

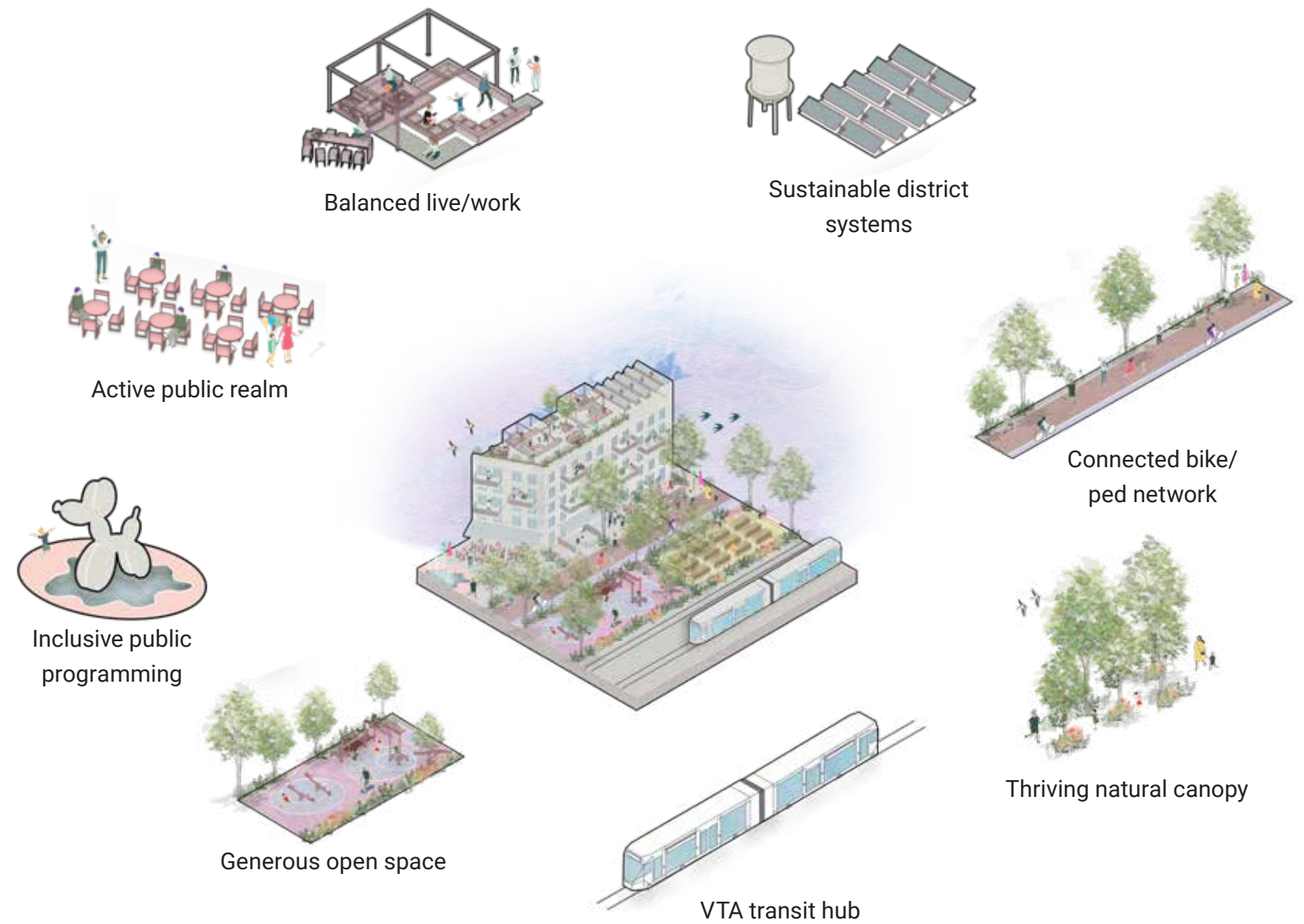

Figure 2.1.3 Components of place

2.2 Community process

Starting in July 2016, the City of Mountain View led a robust public planning process to create a transformational vision for the East Whisman Precise Plan area. City staff convened two community workshops in 2016, and between 2016 and 2019 held twenty public hearings that included public comment periods to receive additional community feedback.

The input from this process informed the Precise Plan, which was formally approved in November 2019. The approved Precise Plan has, in turn, shaped the concepts for the proposed Middlefield Park Master Plan.

Since September 2020, the Project team has conducted over 55 meetings with community members and local groups, representing over 275 unique individuals, to inform and receive feedback on the Master Plan proposal. In addition, three publicly noticed community meetings were held in December 2020, which 50

unique community members attended across the three sessions with identical content. In April 2022, the team held two publicly noticed community meetings with identical content to provide an update on the project and receive additional input, where 60 unique community members attended.

The following City of Mountain View advisory and approving bodies have reviewed the Middlefield Park Master Plan and/or Development Agreement via public meetings:

- Development Review Committee;
- Zoning Administrator (only reviewed Development Agreement);
- Environmental Planning Commission;
- City Council.



Figure 2.2.1 Illustrative rendering of open space character

2.3 Delivering Precise Plan guiding principles

The East Whisman Precise Plan sets out a series of guiding principles that envision the district transformed – from a largely single-use office park – into a vibrant neighborhood, alive with a mix of uses, and oriented to support the rich opportunity of abundant transit, bicycle, and walking connections. The plan for Middlefield Park and corresponding Urban Design Objectives respond directly to the East Whisman Precise Plan guiding principles, and builds on them in the following ways:

Transform East Whisman into a mixed-income community with a balance of renters and owners

Neighborhoods that have a diversity of land uses and incomes make for more vibrant, resilient, and healthy communities – where everyone can benefit from proximity to transit, jobs, and enhanced access to open space and recreation.

Middlefield Park will be a mixed-use community with jobs, housing, and services for a livable, complete, community, one that is open and accessible to all incomes, ages, and lifestyles. The Project takes full advantage of the Precise Plan's density allowances to maximize its housing offer. This includes units that are affordable by deed restriction, and also affordable by design, with units offered at a range of sizes. In addition to offering rental housing units, the project will be condo mapped to allow for future ownership structures should the market support that approach.

Housing is set within a dense, urban neighborhood designed to support connections to transit, open space, and bike and pedestrian networks, in order to increase connections between residents, employees, and visitors.



Create a complete neighborhood

Middlefield Park conceives of a “complete neighborhood” as one where residents, employees, and visitors of all income levels, ages, and abilities can easily access the things they need for daily life – without having to get into their cars. Whether one travels by train, bus, bike, foot, or wheelchair, it will be easy to get to the neighborhood. The existing VTA Light Rail station can become a gateway to a true community, with neighborhood services like a market and restaurants, and opportunities for social connection.

Once there, it will be an easy, enjoyable and safe place to move around, whether on larger streets with generous sidewalks and bike lanes, or on paseos that wind between small, walkable blocks. It will be a place where the streets are alive with ground floor uses that spill onto sidewalks during the day and on into the warm evenings with a variety of activities to bring residents and neighbors together. Parks, promoting physical and mental well-being, will offer abundant opportunities to gather and play with friends young and old, as well as quiet moments of solo respite.

Everywhere, the experience of the public realm will be comfortable, with plenty of places to sit or lock a bike, and a lush canopy of healthy trees overhead offering dappled shade. Throughout the year there will be a variety of ways to observe the passing seasons and connect with nature: the changing colors and textures of the landscape; the migration patterns of birds and butterflies; and the seasonal events that engage fellow residents, workers, and visitors.

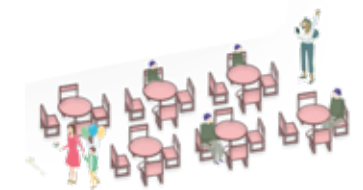

DESIGN CONCEPT



Focus activity and development around VTA Middlefield Light Rail Station

Foundational to this Master Plan is the idea of locating density in proximity to transit. Not only does this create a more walkable community – one where residents, employees, and visitors can easily access transit – it also improves ridership on VTA Light Rail. Ellis Park will also be the first park located immediately adjacent to a VTA Station, which could increase ridership on this system while improving park access for other communities located along the line.

The Project has been designed to support a station experience that is lively, convenient, and walkable. The station will front onto Ellis Plaza, an active urban node of public space ringed by a welcoming mix of eateries, shops, services, and possibly a market, creating a sense of arrival at an urban destination that serves the daily needs of local residents. Extending from Ellis Plaza is an enhanced greenway designed to support safe, easy, and enjoyable bike and walking connections which will also be located immediately adjacent to a VTA Station.



Integrate new housing harmoniously with office uses

One of the most transformative elements of the EWPP is the introduction of housing into what is currently a homogeneous, low-density employment area. The Middlefield Park Master Plan makes maximum benefit of this mix of uses by organizing residential and office zones so that central open spaces are fronted by both uses. This ensures that Maude Park and Ellis Park will be activated by the coming-and-going of residents, employees, and visitors throughout the work week, on weekends, and in the evenings.

The Project is designed to maximize the benefit of mixed-use development while minimizing the impact of office servicing and loading on residential buildings. Parking, loading, equipment, and utilities will be consolidated and located at the perimeter of the site, generally away from residential buildings, or provided within the parking garage of the office buildings.



Maximize land use flexibility while balancing jobs and housing

The MPMP responds to the need for a balance of jobs and housing by providing a mix of uses at the ratios prescribed in the EWPP. Net new office will support the Jobs/Housing Linkage Program which has been specifically designed to facilitate residential development and integrate housing into the East Whisman plan area.

The strategy for the ground floors of these buildings will also support a lively public realm with flexibility for many different types of active uses to inhabit and enliven the edges of streets and parks, thereby inspiring and bringing together the community. Uses found at the ground floor may include: restaurants; cafes; shops; residential lobbies and units; and office social spaces that welcome new concepts and provide an opportunity for local entrepreneurs.

Because connections are at the heart of the MPMP, residential buildings will offer space for community gatherings and events to complement the site's community-focused and connected public realm. This will allow residents and employees to use these spaces to gather with friends, to meet with organizations, to celebrate life events, and connect with one another in many other creative ways that support and strengthen the social bonds of the community.

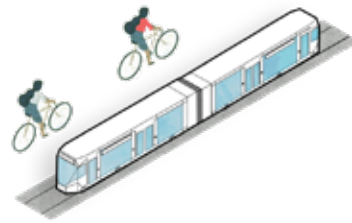

Minimize motor vehicle trips

Middlefield Park is designed around transit, walking, and bike connections. By locating a dense mix of housing, jobs, and services close to transit, the Project will reduce the need for residents and employees to drive to work or to run errands. This will not only reduce greenhouse gas emissions; it will also help commuters avoid the social isolation of spending ever-increasing time alone in the car, stuck in traffic.

The entire site is within a 10-minute walk of VTA Middlefield Station, and all buildings will be just a few steps from one of the site's large parks. A bike path passes through the site that connects to the larger 500-plus miles of Bay Trail. Downtown Mountain View and Downtown Sunnyvale, and their associated Caltrain Stations, are reachable within a safe, 15-minute bike or light rail ride, as are the employment centers at North Bayshore and Moffett Park. A local elementary school (Vargas) is minutes away on foot.

Google is at the forefront of innovating for changes in how people and goods will move around cities in more sustainable and convenient ways. This site captures that thinking and major changes in the future of mobility are anticipated in the Project, including: curbside flex-zones; adaptive parking standards; and accommodating emerging micro-mobility modes.



Build complete streets for active transportation

"Complete streets" are streets that are designed and operated to enable safe access for all users, including pedestrians, bicyclists, motorists, and transit riders of all ages and abilities. They make it easy to cross the street, walk to shops, and bicycle to work. Complete streets also allow buses to run on time and make it safe for people to walk to and from train stations.

The MPMP envisions a complete mobility network where all streets on-site and along the project site frontages are designed as complete streets, enhanced by an expanded network of pedestrian and bicycle paths. The Project's streets and paths have also been organized to convey a sense of hierarchy and easy and intuitive wayfinding.

The MPMP supports the City's idea for a bike/ped bridge over the VTA corridor to further advance the vision for a complete mobility network, not just in Middlefield Park but in all of East Whisman. Accordingly, the Project Applicant has agreed to fund up to \$250,000 toward a design concept/feasibility study for such a bridge within the MPMP area.



Create a highly sustainable community

Designing sustainable master plans — as opposed to individual buildings or open spaces — presents a unique opportunity: to build a holistic set of systems, both environmental and social, that benefit from the connectivity and diversity of the collective place.

A holistic approach to sustainability also brings co-benefits, where interrelationships between systems amplify the benefits of one another. For example, Middlefield Park prioritizes sustainable modes of transit (like walking, biking, and public transit). This strategy alone may reduce carbon emissions. When combined with the strategy of a diverse mix of land uses, it can improve public health by increasing active modes of transit and enhance social and physical connectivity. Paired with opportunities for affordable housing, non-transactional public spaces and a range of neighborhood-serving retail, this is a place where systems of support in the design and program of the place allow everyone to thrive.

Google's sustainability strategy for the Master Plan prioritizes decarbonization, resilience, ecological restoration, resource management, and healthy communities. The sustainability strategy is embedded in all topic areas discussed in the MPMP: land use; parks and open space; circulation and mobility; building design; and opportunities with district infrastructure.

2.4 Design framework

Located between the downtowns of Mountain View and Sunnyvale, NASA Ames, North Bayshore, and Moffett Park, Middlefield Park will be a community at the heart of eastern Mountain View.

Contextual design

The Master Plan site is located within a triangle formed by three freeways: US 101, SR 85 and SR 237. This area is currently defined by a landscape of office parks, parking lots, a lack of services and amenities, and fragmented connections to surrounding jobs and retail. However, just beyond the EWPP boundary are regional job centers, main streets, existing residential neighborhoods, and regional transit connections that the Project will leverage to create a new locus of activity and community.



Figure 2.4.1 Middlefield Park location between downtowns and VTA stations



Building on existing opportunities

The site is served by the existing VTA Orange Line, which stops within the site at VTA Middlefield Station and connects to Downtown Mountain View and Caltrain to the west, and the job center of Moffett Park to the north. It will eventually connect further on to the Bay Area Rapid Transit (BART) connection in Milpitas.

In the area surrounding the site, a growing network of regional bicycle lanes will become available for residents, neighbors and employees wanting to travel safely by bike to Downtown Mountain View, Mountain View Transit Center (including Caltrain Station), major Mountain View and Sunnyvale employment centers, and bayfront open spaces.

This Master Plan looks to unlock the potential of this area to connect to surrounding job centers, existing neighborhoods, and regional bike routes, while adding housing, retail, community uses, and open spaces in a walkable setting of a complete neighborhood.

-  Middlefield Park
-  East Whisman Precise Plan Boundary
-  VTA Route
-  Bike Route
-  Cal Train
-  101 Highway

Figure 2.4.2 Middlefield Park location within the East Whisman Precise Plan boundary

DESIGN CONCEPT

Shaping the Master Plan: three big moves

The Master Plan is shaped by three main strategies to deliver a connected community. These strategies build upon the intent of the Precise Plan and form the structuring elements related to movement, open space and land use.

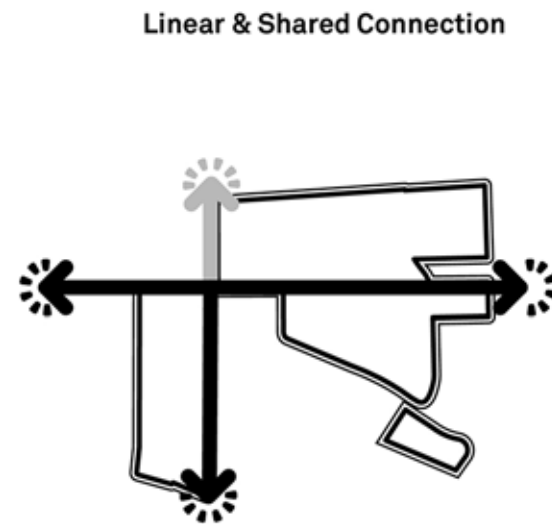

New east-west and north-south connections: Linking neighborhood-wide access to the station, joining regional routes for transit and bike commuting, and connecting adjoining neighborhoods into this place, thereby increasing mobility and promoting active lifestyles.

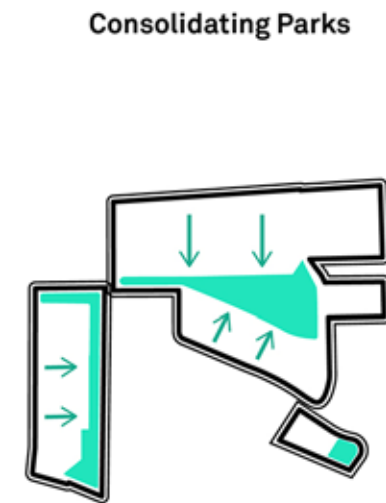

New parks at the heart: Generous shared amenities that connect residents, neighbors, and employees of all ages, incomes, and abilities to opportunities for quiet and restorative spaces in nature along with larger areas to accommodate a wide variety of interests and types of recreation.

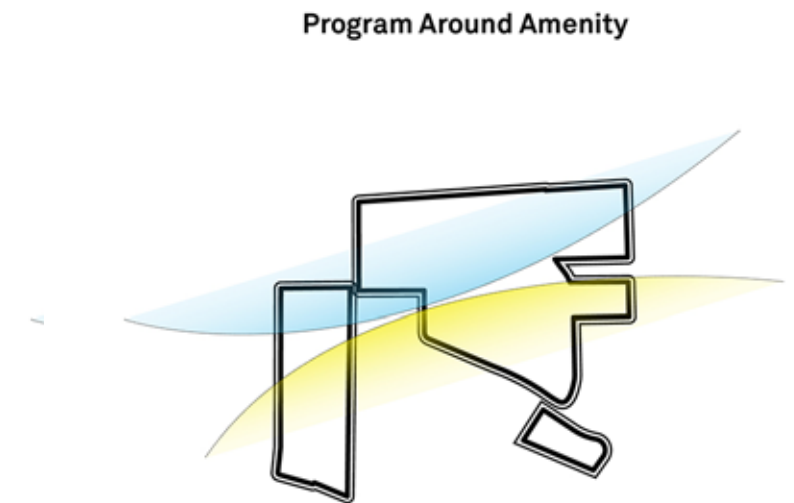

A balanced live/work neighborhood: The introduction of residential uses accessible to a range of incomes into what is currently a single-use office park, in alignment with the jobs/housing target, establishes a balanced neighborhood with greater utilization of new parks and services for a vibrant public life.

Land use framework

A mix of residential, office, retail, and community space uses are proposed for Middlefield Park. This mix of uses is organized to create a complete community that will support a walkable lifestyle, where people can easily access amenities close to where they live and work.

Open spaces and streets will be fronted by a variety of uses, enlivened by a diversity of residents, employees, and visitors coming and going throughout the work week into the evenings and on weekends. Neighborhood retail and services, along with food and beverage options programmed with a range of events, pop-ups, and markets will energize the area around VTA Middlefield Station. These will provide a real town square feel for residents, workers, and visitors to feel welcomed into the community. Residential stoops and/or active ground floor uses around Maude Park could help activate this new destination through events and neighborhood programs that are intriguing and interesting for people of all ages, lifestyles, and abilities.

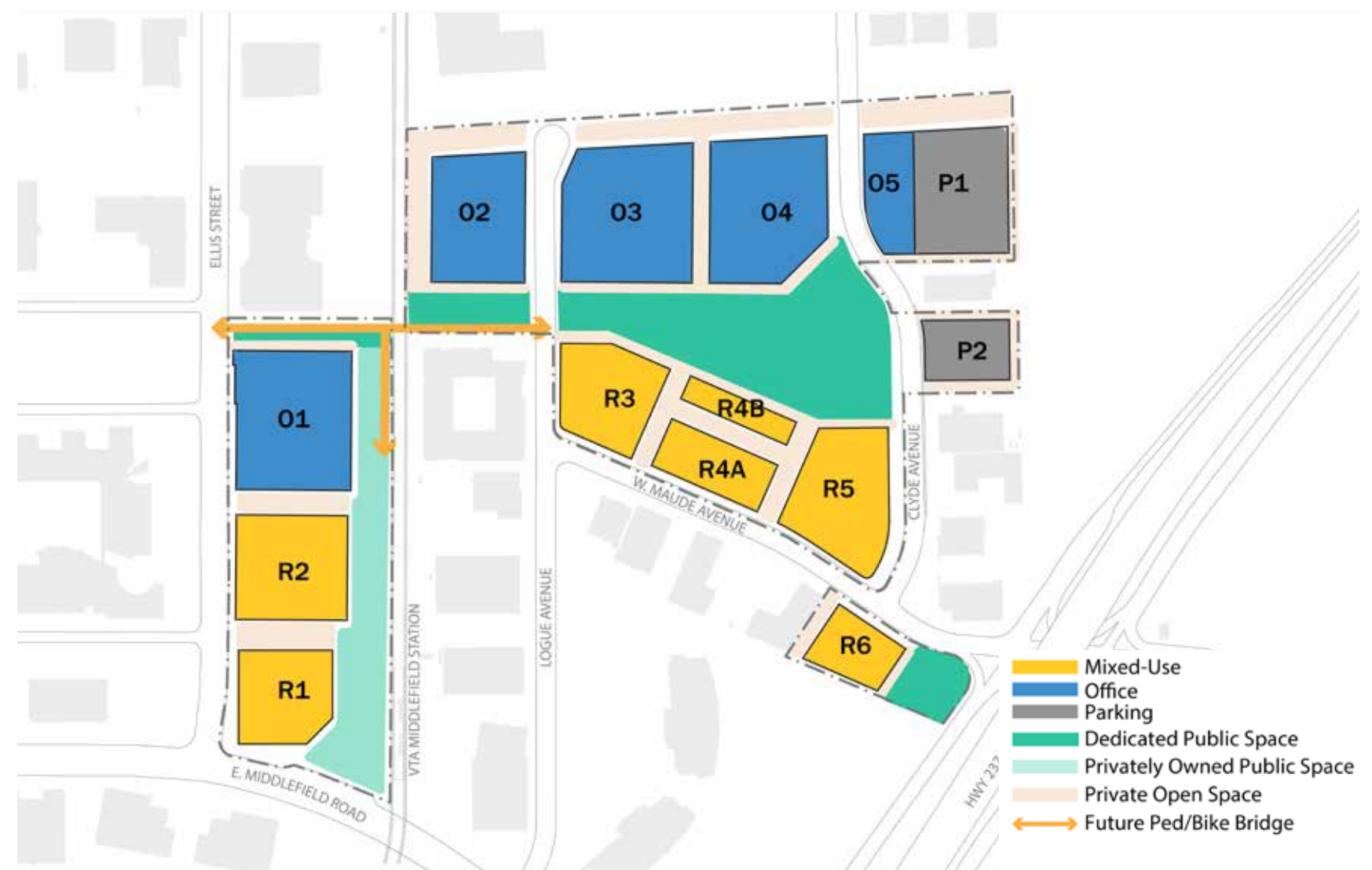

Figure 2.4.3 Middlefield Park land use framework

DESIGN CONCEPT

Open space framework

The site will offer a range of open spaces, from active plazas and promenades hosting a mix of events, to generous green spaces that provide for active recreation and passive recreation. A series of smaller open spaces will link the network and create a variety of inviting places throughout the neighborhood. Overarching the entire network is a lush and expansive tree canopy connects the public realm, creates shade to reduce heat island effect, improves outdoor thermal comfort and air quality, sequesters carbon, and advances ecological goals.

Though important remnants of the Santa Clara Valley's historical ecology persist within Mountain View and surrounding regions today, the current landscape's ability to support native species and ecological communities is extremely limited. To address this, the Project will use a variety of native plant communities to create much-needed and well-connected ecological landscapes across Middlefield Park. The open space network will give a rare opportunity for residents to experience the natural heritage of the region – including lost native ecosystems – as part of their daily life in a resilient and healthy urban landscape. These native plant communities will also help differentiate various open spaces within the plan area.

The continuous tree canopy connecting these spaces is a visual reminder of the site's goals as a green oasis of health for people and the environment. Google's tree farm, started in 2021 in the south bay, will ensure the availability of quality, native tree species of all different sizes to enable the creation of mature or nearly mature landscapes

at the time of planting. Through an expanded urban forest, re-oaking, green corridors, high-value ecological patches, and nature-based enhanced stormwater management systems, the MPMP can regenerate the site's ecological functions and transform the landscape to support native plant communities and beneficial functions.

Ellis Park, a shaded urban plaza ringed by neighborhood retail and transit connections, will offer varied uses and activities throughout the day. The active outdoor programs along the adjacent greenway bring together picnicking families, joggers, book clubs, and many others in a public realm meant for exploration and participation.

The City will lead the design and development of Maude Park, Gateway Park, and the Bridge Open Space within the MPMP area. According to the EWPP, neighborhood parks greater than 3 acres in (as proposed with Maude Park) size are meant to provide larger open space amenities than mini-parks can provide, such as playing fields, restrooms, and playgrounds.



Figure 2.4.4 Illustrative rendering of a landscaped pathway



Figure 2.4.5 Illustrative rendering of Ellis Plaza



Figure 2.4.6 A range of open space experiences



Figure 2.4.7 Middlefield Park open space framework

DESIGN CONCEPT

Building and massing framework

This Master Plan builds on the Principles in the EWPP and is compliant with its Development Standards and Building Design Guidelines to create a context-responsive and connected community.

The urban form of Middlefield Park will be designed to establish a clear set of public, semi-private, and private spaces that integrate harmoniously with public streets, paseos and parks, while enclosing courtyards for local residents and workers. Blocks will be shaped to a walkable scale with a range of building scales in a contemporary design with the use of context-appropriate materials, textures, and tones.

The ground floors of buildings will create a vibrant public realm throughout Middlefield Park, and will be designed to adapt over time. Building entry points will punctuate and activate Ellis Street, Clyde Avenue, Logue Avenue and Maude Avenue, while commercial facade treatments will welcome and engage pedestrian traffic, supporting a lively retail realm. Residential frontages will be activated by a range of housing types and edge conditions with gardens and stoops, as well as by

frontages that are adaptable for live/work opportunities and aging in place.

Buildings will be designed to hold a consistent street wall condition, particularly along Ellis Street and Maude Avenue. This consistent street wall frames a continuous “street room” formed by the height of the building frontages and the width of the street. At the building scale this is given greater variation and interest through building breaks and changes in material. The overall effect is one of a unified district that also provides variety and interest at the human scale.

The Urban Design Objectives included in the supplementary Implementation Plan document provide more detail on the urban and building forms envisioned within the Project area.



Figure 2.4.8 Examples of human-scale building design

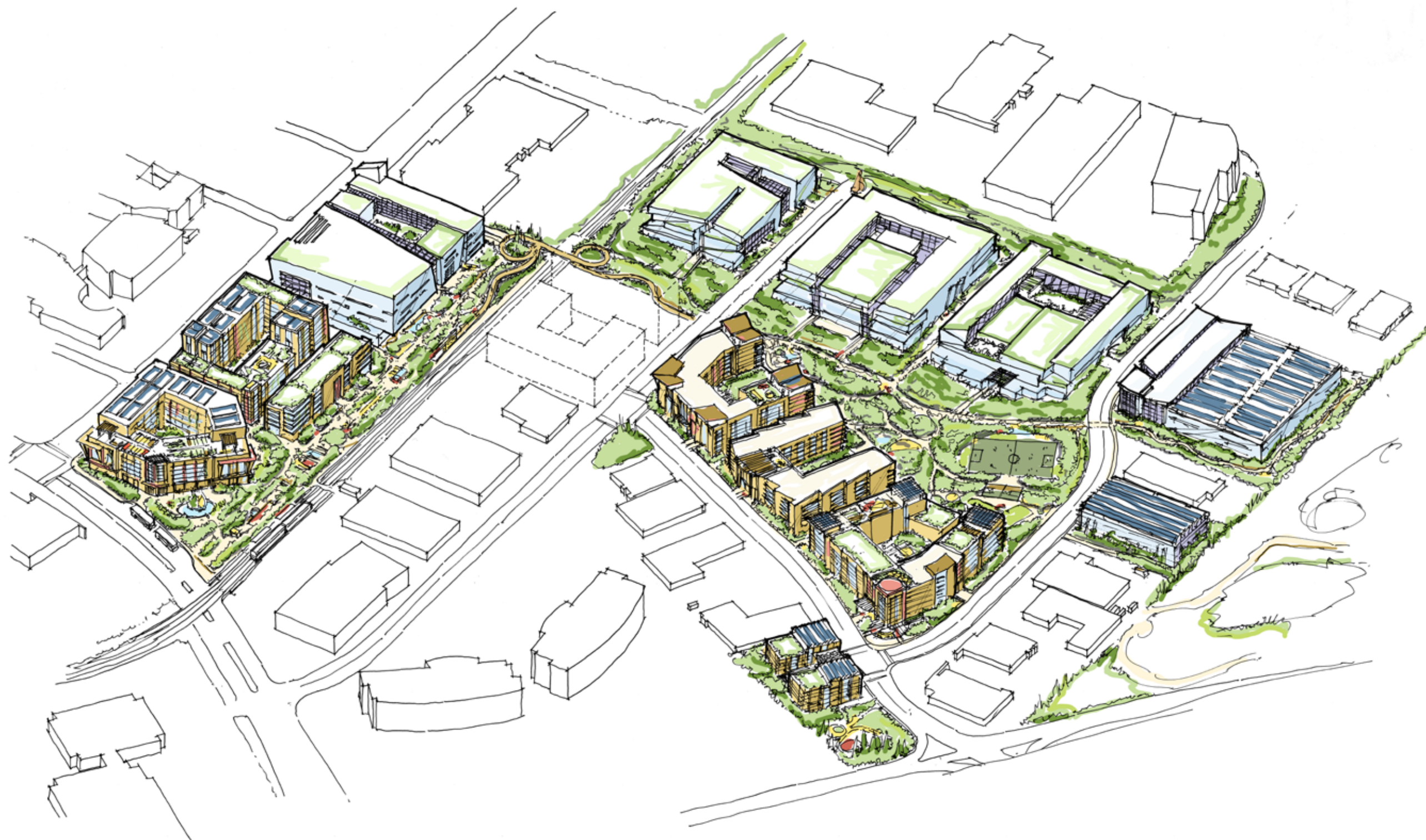

Figure 2.4.9 Bird's eye view of massing concept (Artist's rendering, subject to change)

DESIGN CONCEPT

Circulation and mobility framework

Middlefield Park provides a variety of healthy, affordable, and convenient ways to move around. Walking and biking are encouraged by design. Extensive on-street and off-street infrastructure ensures a variety of routes for people to choose from and allows them to select their desired experience, whether that is the shortest distance from a transit stop, a ramble through open parkland, or an easy detour to shops and restaurants.

Middlefield Park creates a walkable grid of small blocks, making it easy and comfortable to move through the neighborhood on foot, bike, scooter, or via other modes of transportation. The scale of this grid reorients the development away from cars, and focuses on encouraging and rewarding pedestrians. It creates safe places to walk and offers shaded paseos with verdant landscaping. By reserving curb space for drop-off and pickups, residents and visitors have more mobility options, and can more easily avoid driving alone, while keeping cars on the perimeter of the site.

New bike routes through the neighborhood build on existing plans for the region, connecting into high-quality corridors like Ellis Street/ Manila Avenue, Hetch Hetchy Trail/

Stevens Creek Trail (which connects to the Bay Trail), and Sunnyvale's Mary Avenue and Borregas Corridors (via Maude Avenue). Additionally, new protected on-street routes will increase the number of bike commuters. The variety of routes also supports frequent trips within Middlefield Park, offering healthy, active ways for people to run errands, meet with friends or coworkers, and travel between work and home.

Anyone who lives in, works in, or visits Middlefield Park, will find a number of transit options connecting them to the region. As the new neighborhood is centered around the VTA Middlefield Station, stepping onto the Orange Line offers connections to the Mountain View Caltrain Station and the Milpitas BART Station. Bus and light rail service improvements may be planned to

respond to a growing population. Mountain View's MVgo shuttle provides free service between East Whisman and Mountain View Caltrain. Google's GBus employee shuttles already operate in the East Whisman area.

At the core of the vision of Middlefield Park's ambitious plan is a de-emphasis on single-occupancy vehicle transportation. While parking is provided, both office and residential parking rates are planned to be voluntarily lower than the Precise Plan maximums, and retail parking may take advantage of shared parking strategies to reduce the overall amount of parking. Middlefield Park will allow for healthy, accessible options by providing attractive walking, biking, and transit options for everyone.

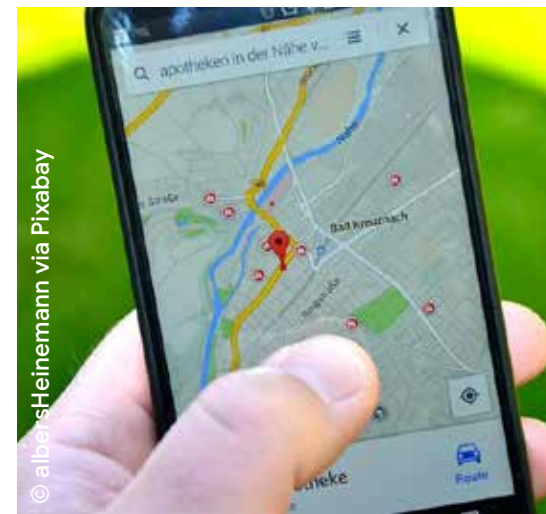

Figure 2.4.10 Physical and digital strategies for supporting sustainable mobility

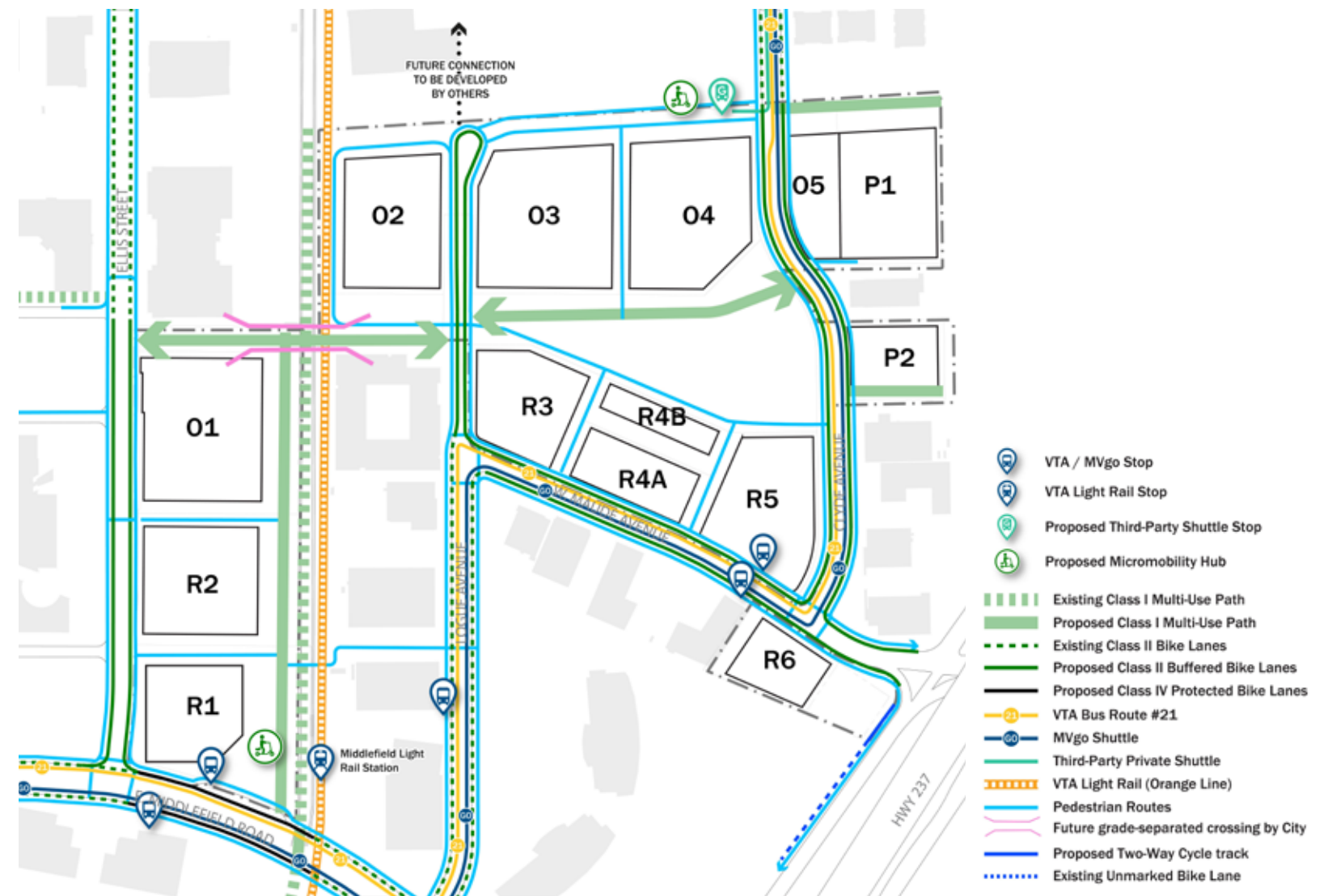

Figure 2.4.11 Circulation and mobility framework

DESIGN CONCEPT

Sustainability framework

The MPMP development will set a high benchmark and a clear precedent for how development in the East Whisman area and beyond can be designed for environmental performance while fostering a deep connection to place. This project's land use, site, and building design will demonstrate and deliver on Google's commitments to water replenishment and restoration and a carbon-free future, with a focus on nature-based solutions.

The plan for Middlefield Park is grounded in a commitment to sustainably building all aspects of the Project. It has been designed in a holistic way to maximize the environmental performance and the benefits to the community through the design of interrelated, mutually supportive systems that make it easy for residents and employees of Middlefield Park to make sustainable choices.

These systems include:

Land uses: By centering the new community around a mixture of housing, neighborhood retail, recreation and community facilities, and employment uses, the Project improves access to everyday needs and reduce commute times, thereby reducing carbon impact. This closely-knit mix of uses also creates a dynamic civic realm that supports an enjoyable and safe environment, and nurtures a rich public life for residents, employees and visitors.

Open spaces: Creating high-quality open spaces accessible to all ages, incomes, and abilities is critical to the long-term health of both the community and regional ecosystems. A robust and connected tree canopy, native drought tolerant plantings, pollinator gardens, and nature-based stormwater solutions will significantly enhance the ecological function and biodiversity throughout the site. The open space design will minimize resource use and sequester carbon while improving health and wellness outcomes through enhanced access to nature, improved air quality, the safety and appeal of active modes of movement and reduced heat island effect. Welcoming public spaces will also foster social bonds and cohesion, creating sturdy relationships and stakeholders who will help sustain the neighborhood and contribute to the stewardship of the natural environment around it.

Circulation and mobility: Middlefield Park is in a prime location for transportation alternatives to single occupancy vehicle trips. The site is close to high quality transit and regional bikeways, located in a developing mixed-use area, and will include on-site services to encourage alternative, carbon-conscious transit behaviors. The site design and the transportation demand management strategies selected for implementation encourage occupants, employees, and visitors to use cycling, walking, transit, and shared rides.

Architecture and building design: Buildings will be designed to carefully manage demand for resources beginning with solar orientation and siting and massing, to systems planning, facade design, and material selection. All office buildings in Middlefield Park will achieve LEED Platinum and all residential buildings will achieve the equivalent of a GreenPoint rating of 120 points or better. Beyond ambitious sustainability ratings

targets, the buildings' relationships to the connected tree canopy and ecologically rich open spaces also create opportunities for biophilia and connection to nature.

District systems: If pursued, this Project will utilize neighborhood-wide district systems to conserve resources, optimize energy and water performance, and increase systems resilience while reducing redundancy within the individual buildings. Further, district-scale utilities would reduce strain on existing city utility systems and deliver better than business-as-usual performance in thermal energy, power, and water. Strategies for efficient building design paired with centralized heating and cooling allow for optimized energy management. Centralization will enable higher efficiency equipment as compared to a building by building approach, driving down energy consumption and associated carbon footprint. Complementary strategies

such as energy storage (both power and thermal) or geothermal piling offer significant economic, environmental, and resilience benefits when combined with an efficient and smart demand and asset management strategy.

Innovative materials: Google is committed to accelerating the market transition to a circular economy. To that end the Project employs a range of design, construction and operational strategies to maximize material efficiency and reuse, minimize waste, use products for their full lifetime, and promote healthy materials and safe chemistry. Multiple buildings are considering the use of prefabricated and Cross-Laminated Timber (CLT) construction materials to sequester and reduce carbon. Compared to the use of concrete and steel structures, CLT provides a transformative building system that is both lightweight, and streamlined in the manufacturing, assembly and delivery processes.

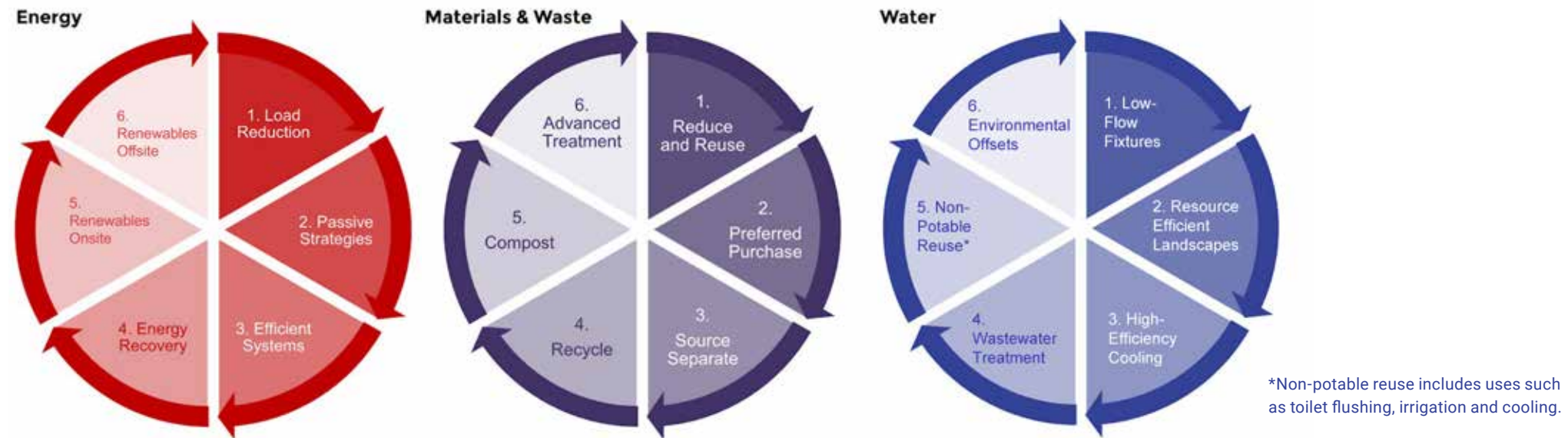

Figure 2.4.12 Indicative resource management strategies



Figure 2.4.13 District systems precedent



Figure 2.4.14 Example of proposed sustainable infrastructure improvements



Figure 2.4.15 CLT precedent

This page intentionally left blank.

3. PROGRAM SUMMARY

The guiding principle for the land use program within the Master Plan is achieving the Precise Plan goal of a balance of jobs and housing in order to foster the creation of a vibrant new community. The two primary uses are complemented by a fine grained mix of others, including retail and service, civic and communal, and passive and active recreation, to create a rich fabric of local place.

3.1 Program summary

Table 3.1.1 Middlefield Park program		
	Existing	Proposed
Residential units ¹	0 DUs	1,675 – 1,900 DUs
Residential (GSF) ¹	0 GSF	1,530,000 – 1,726,000 GSF
Residential Bonus FAR (GSF) ¹	0 GSF	201,937 – 397,936 GSF
Office existing/re-built (GSF)	684,646 GSF	684,646 GSF
Office net new (GSF)	-	558,332 – 632,354 GSF
Office Bonus FAR (GSF)	-	548,904 – 622,925 GSF
Office (GSF)	684,646 GSF	1,242,978 – 1,317,000 GSF
Active Uses (GSF)	-	20,000 – 50,000 GSF
District systems (GSF) ²	-	45,000 GSF
Residential parking (GSF) ³	-	170,000 – 200,000 GSF
TOTAL GSF	684,646 GSF	3,007,978 - 3,338,000 GSF⁴
Site area (sf)	1,736,969 sf	1,740,193 sf ⁵
Public open space area (sf) ⁶	-	350,222 – 397,267 sf

Notes:

Unless otherwise noted, units indicate gross square feet (GSF).

Program ranges shown here are subject to refinement. Throughout this document, the upper end of the range is used to illustrate the maximum potential development.

¹ Total units and areas shown represent an indicative range and are subject to further refinement in future permit entitlements.

² Located partially underground; FAR-exempt.

³ Above-grade parking only shown here; included in residential FAR.

⁴ Total square footage shown represents an indicative range and is subject to further refinement in future permit entitlements.

⁵ Site area increased due to street vacation at Logue Avenue.

⁶ Only includes dedicated parkland and POPA.



12+ acres
NEW OPEN SPACE

2-10 min
WALK TO LIGHT RAIL



3,300-4,000
NEW RESIDENTS



300+
NEW AFFORDABLE
HOMES



50% reduction
OFFICE PARKING
RATIO DECREASE FROM
TODAY

**up to
50,000**
SQUARE FEET OF
ACTIVE USES



Figure 3.1.2 Program summary

This page intentionally left blank.

4. EXISTING CONDITIONS

East Whisman is a major employment center located on the eastern edge of Mountain View that accommodates a substantial portion of the city's office space. It is distinguished from the surrounding neighborhoods by its low density campuses that offer office, R&D, and industrial buildings situated on large parcels of land.

4.1 Site context

East Whisman is largely bound by US 101, SR 237 and North Whisman Road, with East Middlefield Road as the primary east-west connection, and Ellis Street as the primary north-south connection. It sits on the northeastern corner of Mountain View, sharing its northern and eastern borders with Sunnyvale. The San Francisco Bay is roughly two miles north of the area, and Downtown San Jose is about eight miles southeast of the area. Downtown San Francisco is about 30 miles northwest of the area.

Middlefield Park is a ±40-acre site, roughly 1,000 feet wide and 1,900 feet long, bounded by Ellis Street, East Middlefield Road, Logue Avenue, Maude Avenue and Clyde Avenue. The limited amount of existing open space consists of private and residual landscape areas.

Land use context

Older, low-rise office and light industrial buildings with surface parking are the predominant land use in East Whisman today, including all parcels within the Project area. Established residential neighborhoods, including Wagon Wheel, North Whisman, Slater and Whisman Station adjoin East Whisman to the west and south. On the eastern edge of the site is the Sunnyvale Municipal Golf Course, and immediately to the north of the Project area the San Francisco Public Utilities Commission's (SFPUC) pipeline corridor transverses East Whisman from east to west. See Chapter 5 for a plan of existing and proposed uses.



Figure 4.1.1 Existing area map

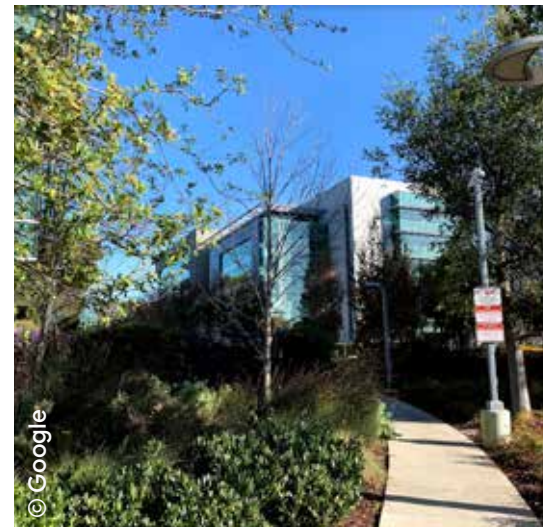

Figure 4.1.2 665 Clyde Avenue

Physical site conditions

Topography within the Project area is generally flat, sloping downward at approximately one percent to the north.

The Project area is located entirely within a FEMA flood zone with reduced flood risk and no established base flood elevations, meaning that buildings do not have a required minimum finished floor elevation. Flood Zone X is defined as areas of 0.2 percent annual chance flood; areas of 1 percent annual chance flood with average depths of less than 1 foot or with drainage areas less than 1 square mile; and areas protected by levees from 1 percent annual chance flood. This area is shown on Flood Insurance Rate Map (FIRM) Number 06085C0045H dated May 18, 2009.

No known significant natural waterways traverse the area, and the site does not have any significant natural areas. The ecological value of existing conditions is minimal. For example, many of the existing trees are non-native and therefore offer limited ecological value. Groundwater within the Project area was encountered between 6 feet to 12 feet below the existing ground surface based on preliminary geotechnical investigations. Variations in groundwater levels should be anticipated. Groundwater mapping of the region indicates that the historic high groundwater level is approximately 5 feet below ground surface in the project area.

Existing utilities serving the area are both publicly and privately owned. The water, storm, and sewer networks are

owned and operated by the City of Mountain View. The electrical and gas networks are owned and operated by PG&E. Communications networks are owned and operated at least in part by AT&T, but verification is needed to determine if there are additional private utilities in the Project area. Additionally, there is an existing nitrogen gas line which runs between Logue Avenue and Clyde Avenue, owned by a third-party.

EXISTING CONDITIONS



520 Clyde Avenue



530 Logue Avenue



401 Ellis Street



Middlefield Road looking west



500 E. Middlefield Road at Ellis Street looking east



Ellis Street near 475 Logue Avenue looking south

Figure 4.1.3 Photos of existing site conditions

4.2 Open space and ecological context

The existing character of the East Whisman landscape and public realm is typified by large streets and parking lots paved in asphalt. Existing trees are predominantly limited to streets and parking areas. However, there are some large scale or dense planting areas today, such as the tree line along the VTA corridor and within buildings' open spaces.

In the district there are few parks or open space amenities, with limited tree canopy. Within the Project area there is no improved public open space; a small, recently improved but unprogrammed open space exists immediately off-site on Ellis Street at the approximate location of Street B in the Precise Plan. Figure 4.2.1 shows the limited extent and fragmented character of the open space context.

The ecological value of existing conditions is minimal. For example,

many of the existing trees are non-native and require more water than locally native alternatives, and therefore offer limited ecological value while requiring more resources.

When supportive of the project's ecological goals of climate resiliency and high biodiversity value, and financially feasible, efforts will be made to preserve or relocate existing trees, especially native and heritage trees, within Middlefield Park. Material reuse opportunities will also be explored for non-ecologically valuable existing trees.

There is great potential to build ecological connections (corridors) and large areas of native vegetation (patches) via conscientious new development. New landscape improvements can bring back missing elements of the Valley's natural heritage, while also building resilience for a warmer climate.

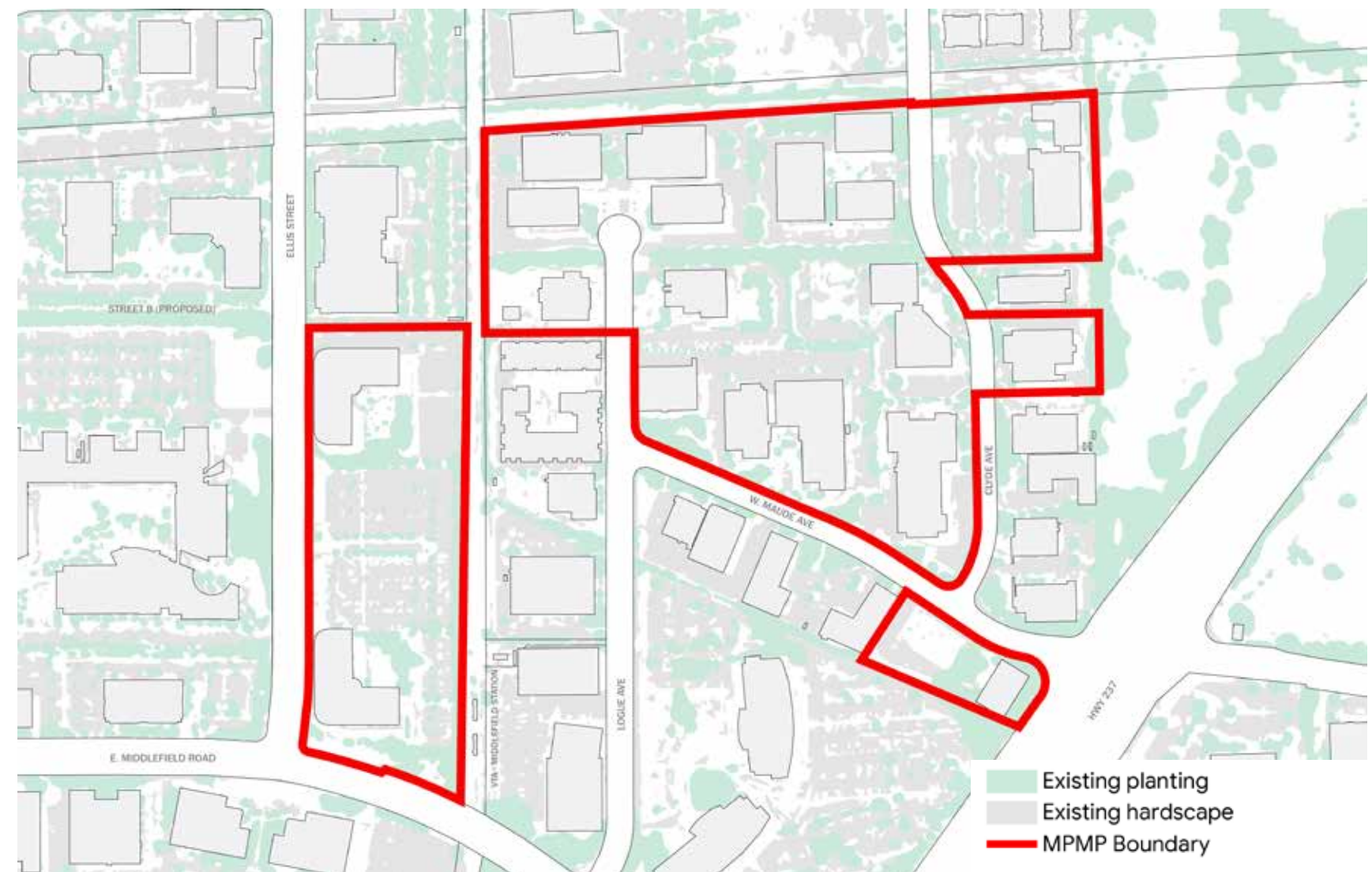

Figure 4.2.1 Existing planting and hardscape

4.3 Circulation and mobility context

The existing site fabric is auto-oriented and prioritizes wide streets and surface parking lots. Where sidewalks are provided, they are small and do not reinforce desire lines between different uses. Access to existing transit connections is limited because of long blocks and surface lots.

Existing street network

The EWPP plan includes two street types for public roadways as follows:

- **Avenues:** Have mixed residential and commercial frontages and are wider than other streets, including a generous landscaped median and dedicated left turn lanes. They balance all modes, with dedicated bicycle facilities, high quality transit stops, and generous sidewalks. Avenues connect regional routes to other street types.
- **Local Streets:** Primarily serve local traffic to adjacent uses. Low travel speeds, wide sidewalks and dedicated bicycle facilities help encourage travel by non-vehicle modes.

The existing street network within the Project area consists of five perimeter streets that are categorized as either Avenues or Local Streets.

- **Ellis Street:** A four-lane north-south arterial street that extends from Manila Avenue to Middlefield Road. It extends through the EWPP area and serves as one of the major access points to US 101. The posted speed limit on Ellis Street is 40 mph.
- **East Middlefield Road:** A four-lane, east-west Avenue that extends through the EWPP area from Central Expressway in Mountain View to Winslow Street in Redwood City. Most of E. Middlefield Road has a raised median near the project area. E. Middlefield Road includes Class II bicycle lanes west of Bernardo Avenue. The posted speed limit on East Middlefield Road is 35 mph.
- **Logue Avenue:** A two-lane, north-south Local Street within Middlefield Park that extends north from Middlefield Road and ends in a cul-de-sac. Logue Avenue provides Class II bicycle lanes and on-street parking south of Maude Avenue and on-street parking

throughout. The posted speed limit on Logue Avenue is 25 mph.

- **Maude Avenue:** A two- to four-lane, east-west Local Street that extends from North Wolfe Road in Sunnyvale to Logue Avenue in Mountain View, providing direct access to Middlefield Park. Maude Avenue provides Class II bicycle lanes west of Borregas Avenue through Middlefield Park. The posted speed limit on Maude Avenue is 25 mph.
- **Clyde Avenue:** A two-lane Local Street along the northeastern edge of the Middlefield Park area that extends between Fairchild Drive and Maude Avenue. Clyde Avenue provides Class II bicycle lanes and on-street parking along its entire extent. The posted speed limit on Clyde Avenue is 25 mph.

Existing transit network

Middlefield Park is well-connected to several transit modes, including

Caltrain, VTA Light Rail, and local and regional bus services. Currently, low frequencies and a lack of integration limit the ridership of the transit network. However, modernization programs such as the electrification of the Caltrain corridor or potential increases in frequency of the VTA Light Rail may support an increase in transit ridership.

Caltrain, the linear backbone of public transit connectivity from San Francisco to San Jose, serves both the Mountain View and Sunnyvale stations, each located approximately 2 miles from Middlefield Park. The Mountain View Station, slightly closer in road network distance and, more importantly, reachable in five minutes by VTA Light Rail, provides a daily service during peak periods of four trains per hour, per direction, including an hourly “Baby Bullet” train linking San Francisco and Mountain View in approximately 45 minutes. The Caltrain Modernization Program, of which the most notable

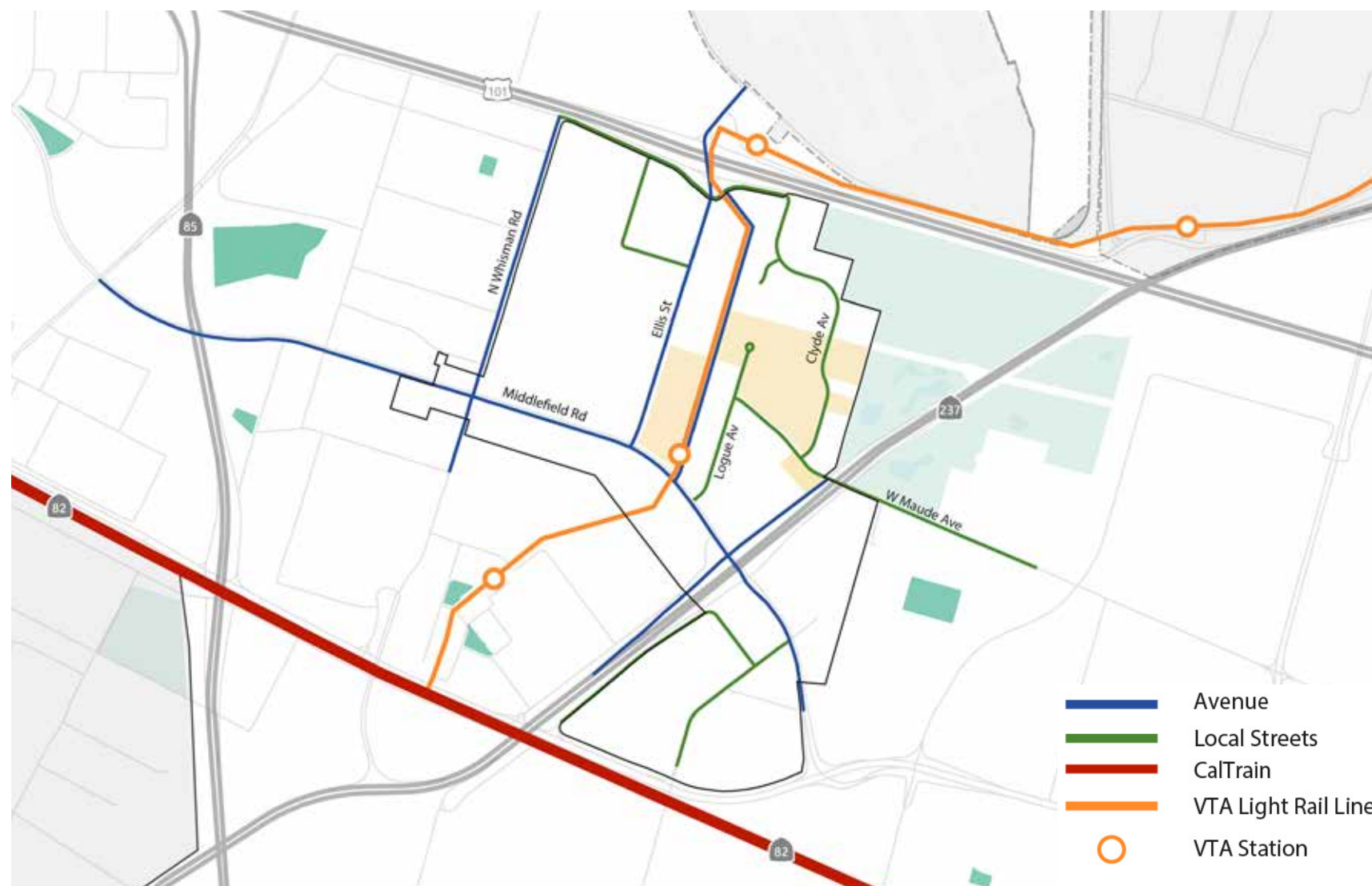

Figure 4.3.1 Street Typologies per East Whisman Precise Plan

component is the electrification of the corridor (currently under construction) from San Francisco to Tamien Station, will include capacity, efficiency, and fleet enhancements in anticipation of shared service with future high-speed rail.

The VTA Middlefield Station is located on the southern edge of the site, equidistant between Ellis Street and Logue Avenue, accessible along both sidewalks and internal bicycle and pedestrian paths. The VTA Orange Line light rail service connects the project site to downtown Mountain View (and Caltrain) to the west, Moffett Park to the east, and beyond Moffett Park to the Milpitas Station, which provides a connection to the BART system in the East Bay. The existing VTA Orange Line also provides connections between the VTA Middlefield Station and downtown San Jose (with transfers to the Blue or Green lines). Trains currently operate with 15-minute headways. The VTA also offers a connection to the Great America Station in Santa

Clara, which provides regional rail connections to Amtrak's Capitol Corridor (to Sacramento) and the ACE train (to the Central Valley/Stockton).

In addition to the light rail, Middlefield Park is also served by one VTA bus line and one free shuttle operated by the Mountain View Transportation Management Association (MTVMA). The following bus services operate within Middlefield Park:

- **VTA Route 21** (Stanford Shopping Center to Santa Clara Caltrain): provides all-day service on Middlefield Road, Logue, and Maude Avenues at 30-minute intervals.
- **East Whisman MVgo shuttle** (Mountain View Caltrain loop): provides free and frequent trips to and from Mountain View Caltrain Station during 3-hour peak periods.

EXISTING CONDITIONS

Private shuttle service

The employers in and around East Whisman, in keeping with increasingly ambitious transportation demand management (TDM) programs, operate private shuttles carrying commuters between local office campuses and residential neighborhoods around the Bay Area. Existing shuttle stops are situated on privately-owned land for loading and unloading operations and are concentrated to the west of Middlefield Park along the Ellis Street corridor.

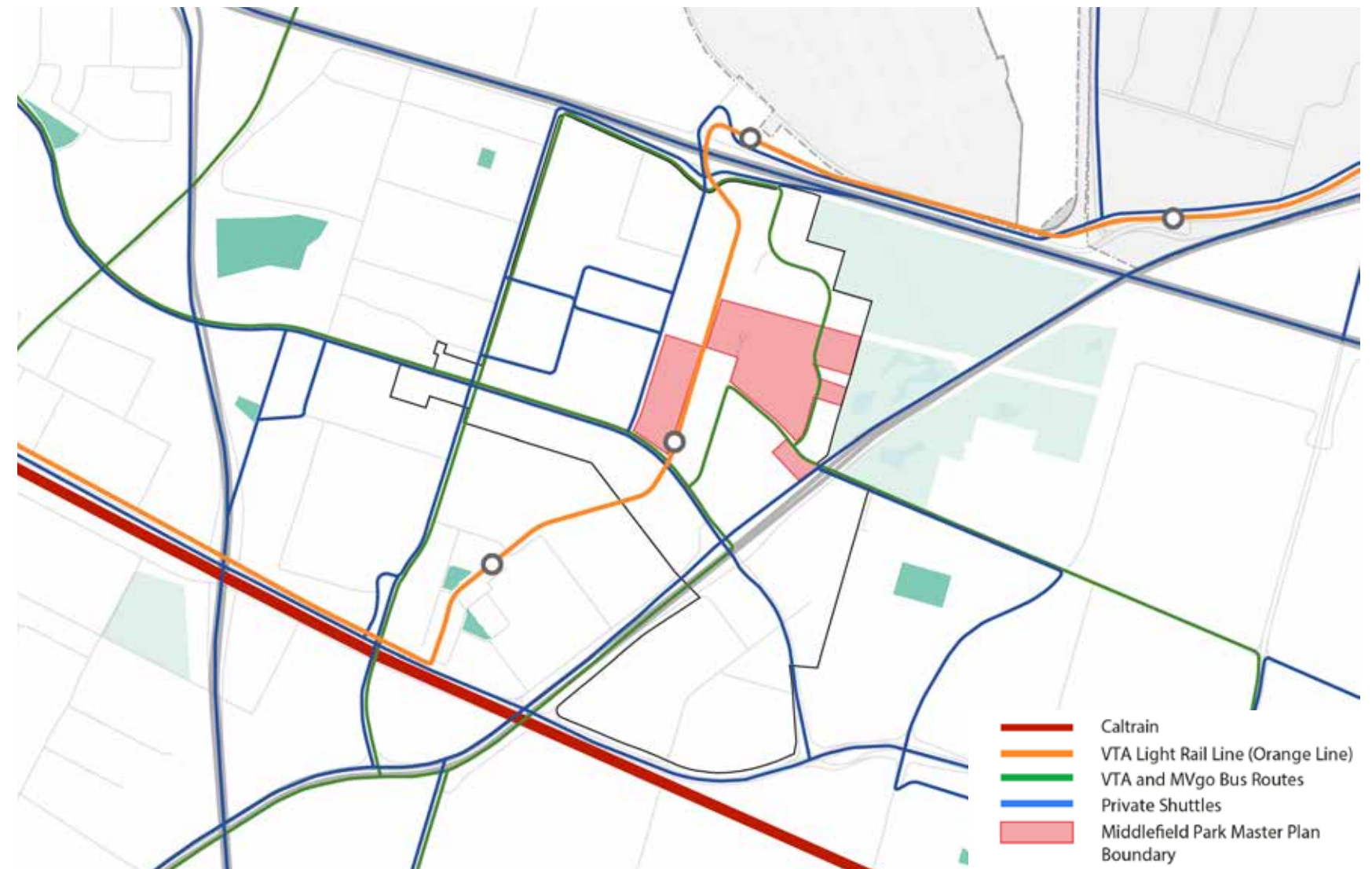

Figure 4.3.2 Existing transit network

4.4 Relationship to other regulatory documents

East Whisman Precise Plan

The Master Plan responds directly to the vision, standards, and guidelines set out in the East Whisman Precise Plan. The EWPP was created through a process of community outreach, as a way to implement the City of Mountain View's 2030 General Plan vision for the area.

The EWPP requires that the area surrounding the Neighborhood Park (named Maude Park in the MPMP) submit a master plan that addresses the development concept for the park and surrounding buildings. This plan is intended not only to satisfy that requirement, but also to provide a holistic planning framework for how this neighborhood will maximize the potential of Middlefield Light Rail Station and Maude Park as important community assets.

The Middlefield Park Master Plan is guided by three EWPP character sub-areas that define scale, form, and character:

- **Mixed-Use Character Area – High Intensity:** Transit-oriented development with residential/mixed-use buildings up to 135 feet tall in the high-rise core, 95-foot tall office buildings, and active retail frontages focused around East Middlefield Rd and the VTA Middlefield Station.
- **Mixed-Use Character Area – Medium Intensity:** Residential/mixed-use and office development up to 75 feet tall, within a walkable block structure, and neighborhood-serving open space.
- **Employment Character Area – Low Intensity:** Lowest intensity office and R&D development, up to 60 feet tall.

General Plan

The East Whisman Change Area of the General Plan establishes the primary vision, goals and policies for the area. The EWPP directs specific development goals and design standards to implement the policies set forth in the General Plan. The redevelopment of this area is therefore guided by the EWPP and, by showing compliance with that document, implements the goals of the General Plan.

Zoning Ordinance

The EWPP sets the zoning, land use and development standards. However, regulations not addressed in the Precise Plan, such as standards for specific land uses, are regulated by the Zoning Ordinance (Chapter 36 of City Code).

Mountain View City Code

The City Code includes general regulations for example; for subdivision, open space dedication, fire safety, and operations of certain activities. These regulations apply to this plan. Note: All proposed construction will meet the code in effect at the time of building permit submittal, including local amendments related to Reach codes.

Mountain View Greenhouse Gas Reduction Program

The Mountain View Greenhouse Gas Reduction Program (GGRP) establishes greenhouse gas reduction targets for the City. The GGRP lists measures to reduce emissions, such as green building performance requirements. This project is expected to comply with the GGRP energy conservation and vehicle trip reductions, see Chapter 7 of this document for more detailed information.

EXISTING CONDITIONS

Citywide Multimodal Improvement Plan, Bicycle Transportation Plan, and Pedestrian Master Plan

This plan complies with the 2018 Citywide Multi-Modal Improvement Plan and subsequent 2021 AccessMV plan, as well as the 2015 Bicycle Transportation Plan and the 2014 Pedestrian Master Plan, which provide strategies and improvements to encourage active transportation. The EWPP requires that specific public benefit or district improvement projects, including those that may relate to active transportation, be identified during the review process for each project, and approved by City Council.

Parks and Open Space Plan

The City-wide Parks and Open Space Plan (POSP) prioritizes park acquisition and improvement strategies for the city. The open space requirements in the EWPP provide specific implementation of the general strategies in the POSP to increase the supply of and access to open space. This plan complies with the EWPP and implements the policies of the POSP.

The City began development of a Parks and Recreation Strategic Plan in 2022. When complete, the PRSP will define a clear vision and action plan for the future of Mountain View's parks and open spaces, trail system, recreation facilities, and recreation programs and services. This plan will update the Parks and Open Space Plan and will provide input in the city's design of the future parks dedicated in this Master Plan area.

Community Tree Master Plan

The Community Tree Master Plan (CTMP) is a guide for managing, enhancing, and growing Mountain View's community tree resource. The CTMP is implemented through the Protection of the Urban Forest ordinance (Heritage Tree preservation in Chapter 32 of the City Code), development review and City activities on public streets and public parks. Compliance with the CTMP will be determined during future planning entitlements.

Plan Bay Area 2040

Plan Bay Area 2040 is a regional plan that aims to integrate sustainable land use, housing, and transportation strategies to reduce congestion, improve livability, and lower transportation-related emissions within the nine counties of the San Francisco Bay Area, which was prepared by the Metropolitan Transportation Commission (MTC) and the Association of Bay Area Governments (ABAG). East Whisman was identified as a Priority Development Area (PDA), defined as a higher-density, mixed-use development area near major public transit stops. The adoption of the EWPP satisfied the legal requirements of the PDA funding. Implementation of this plan, in particular the housing units, will contribute toward Mountain View satisfying its Regional Housing Needs Allocation as required by Plan Bay Area. MTC and ABAG have since adopted Plan Bay Area 2050 in October 2021, an update to the 2040 Plan.

5. LAND USE

The Master Plan envisions a mix of residential, office, recreation, retail, and service uses. Consistent with the vision and controls of the EWPP, these uses will create a lively, walkable community for residents, employees, and visitors alike.

5.1 Land use

Land use approach

The guiding principle for the mix and distribution of land uses within the Master Plan is achieving the EWPP goal of a balance of jobs and housing. The two primary uses are complemented by a fine grained mix of others including retail and service, community and cultural, and passive and active recreation to create a rich fabric of local place. The Master Plan's public realm, including its major open spaces, is fronted by a mix of uses to activate and enliven it on weekdays and weekends, with people coming and going from residential buildings, office buildings, and retail or community establishments.

Catalyzing transformation of the district

The Master Plan builds upon the vision established in the Precise Plan of a transit-oriented neighborhood and employment center, dramatically increasing the diversity of land uses beyond what exists today. The Master Plan places a generous neighborhood park at the heart of the existing single-use district. Along the perimeters of the site, connecting to the surrounding neighborhoods, a heterogeneity of land use fosters a variety of experiences for all. Woven through the park and mix of land uses is an amenitized open space and circulation network, connecting the site and the larger district, offering places and pathways for people of all ages. The transformation of Middlefield Park will be the next step in re-casting East Whisman as a desirable and livable neighborhood.

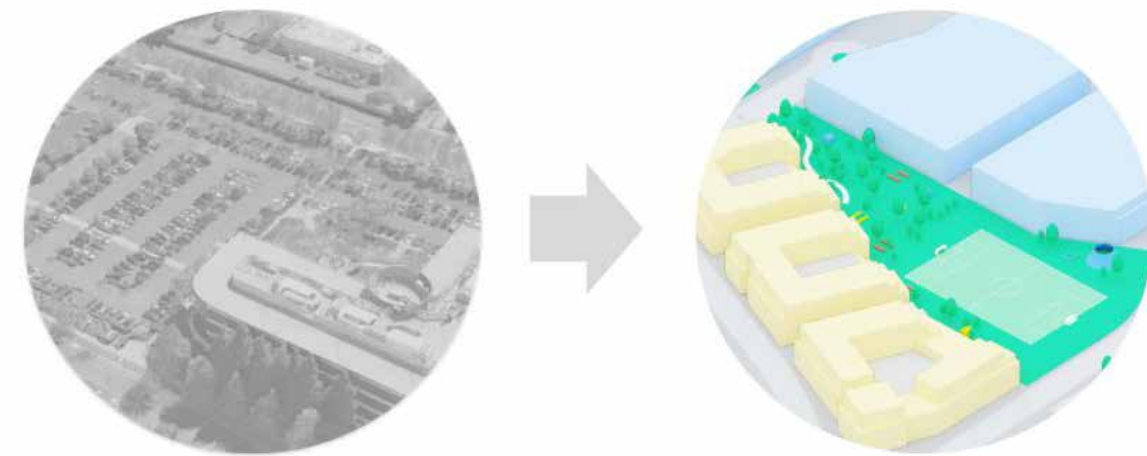

Figure 5.1.1 Comparative site land use: Middlefield Park today and transformed tomorrow

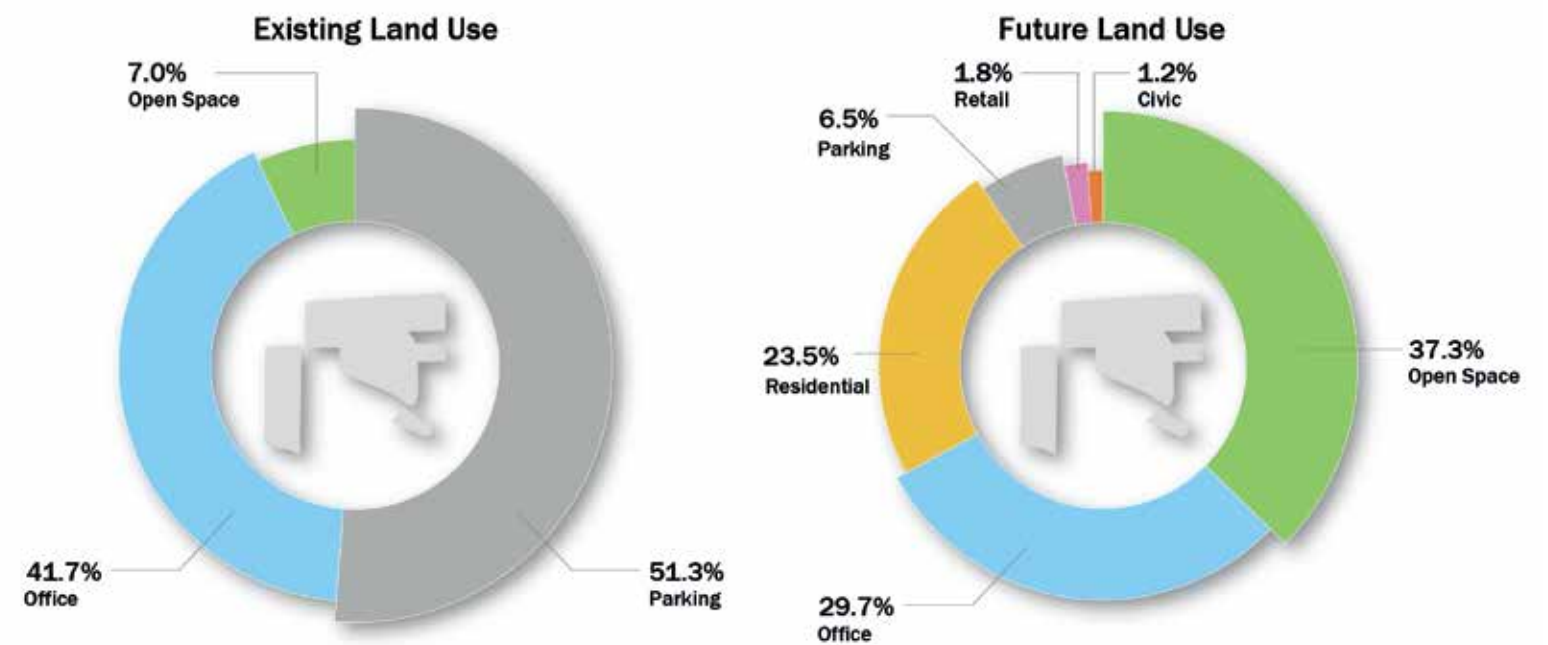

Figure 5.1.2 Existing and future land use

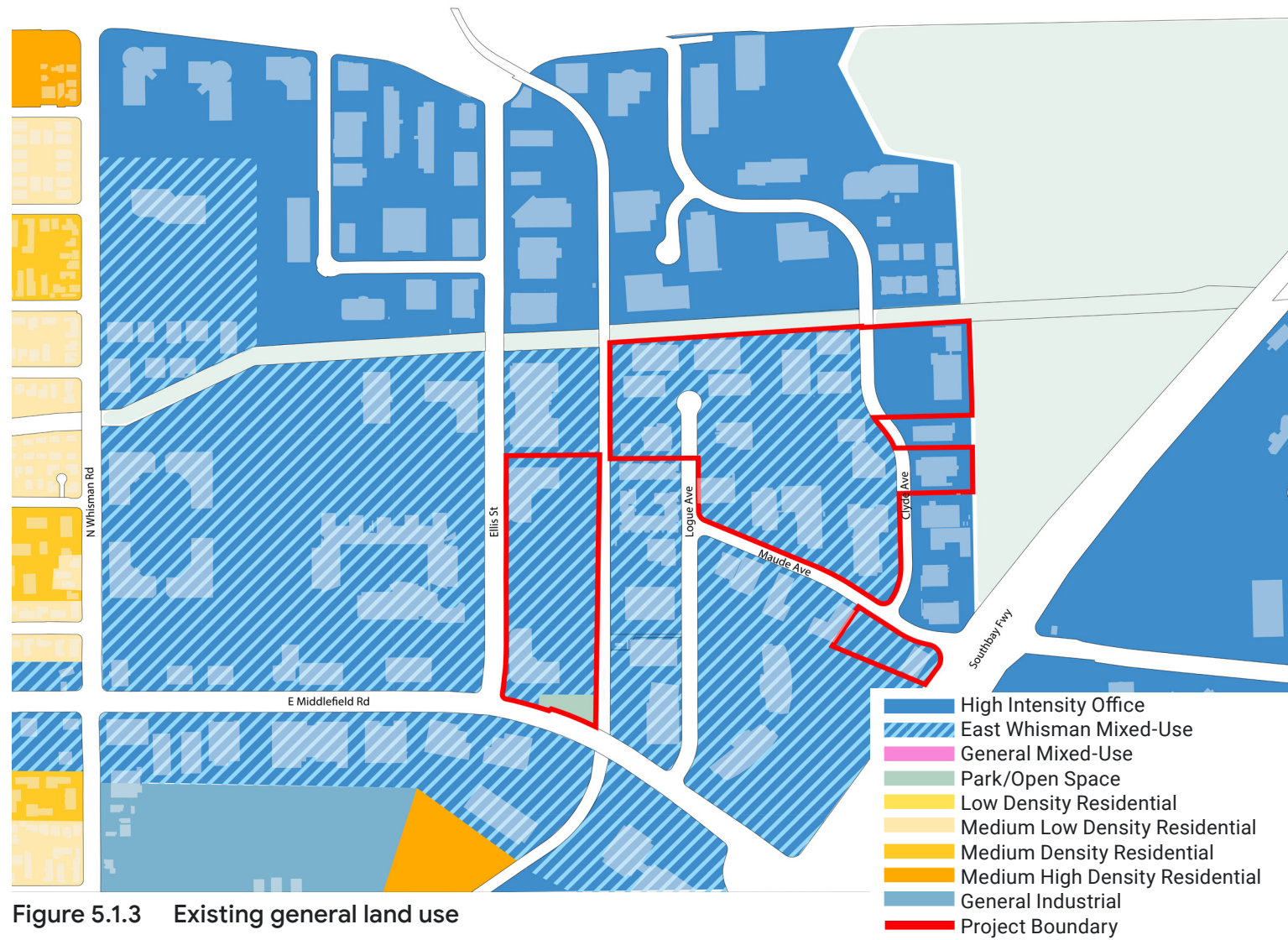

Figure 5.1.3 Existing general land use

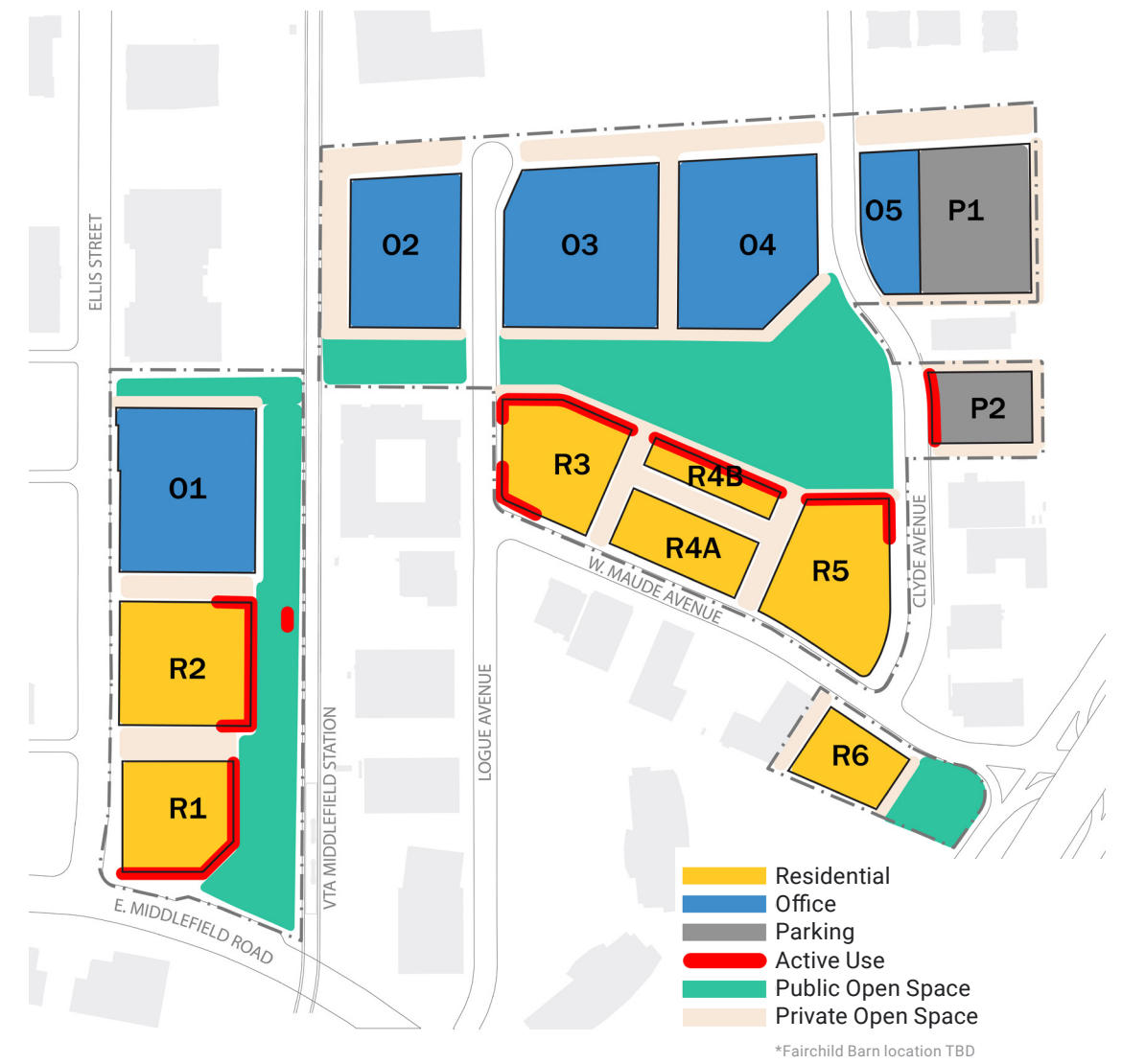

Figure 5.1.4 Land use plan

5.2 Block structure

The block structure of the Master Plan implements the recommendations identified by the Conceptual Public Circulation Map in the Land Use chapter of the Precise Plan. New public streets and other publicly accessible service streets, greenways, multi-use paths, and paseos form a grid pattern that provides new opportunities for pedestrian, bike and vehicular connectivity within the Master Plan area while creating a block structure that builds on the existing geometry within the study area. Consistent with the Precise Plan, maximum block lengths for the proposed Middlefield Park Master Plan are 400 feet in the Mixed-Use Character Area and 500 feet in the Employment Character Area North. The Project also proposes implementation of north-south paseos between the O3/O4 buildings, between the R4/R5 buildings and Maude Park in lieu of the north-south vehicular Street C recommended by the EWPP. For more information on the different street types, see Section 7.7.

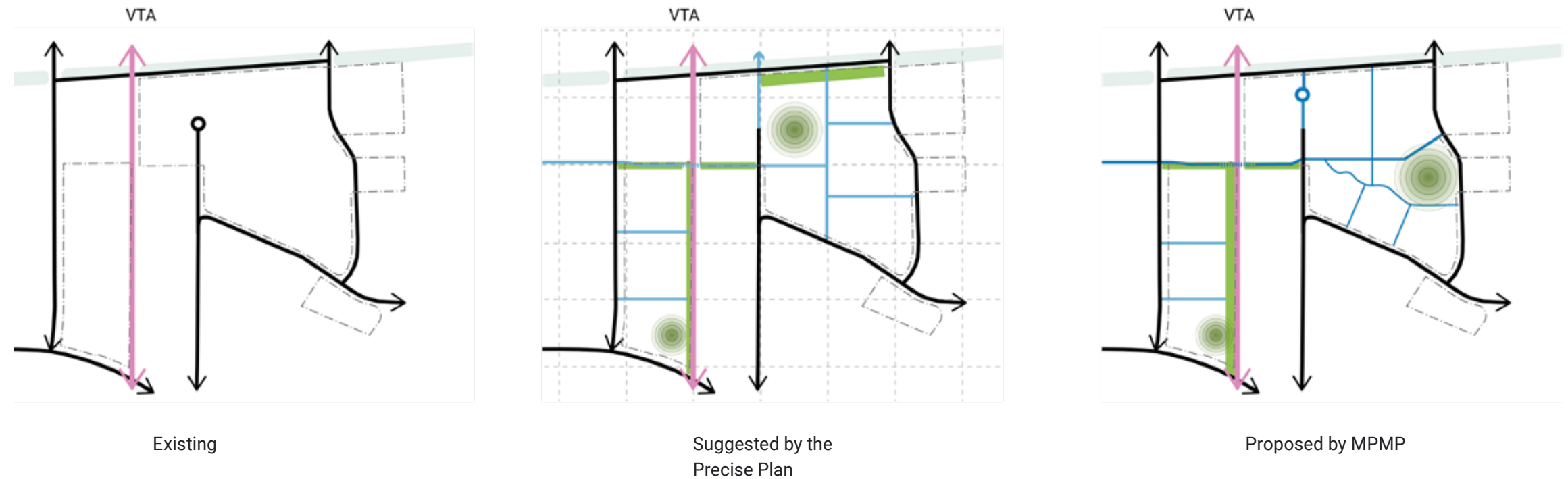

Figure 5.2.1 Transforming the East Whisman block structure

5.3 Development program

The Project proposes a mix of land uses that create a rich tapestry of interactive uses and experiences. While an overall development summary can be found in Chapter 3, more detailed land use information is provided here.

Master Plan Flexibility

The Master Plan includes flexibility to respond to site-specific conditions, development needs, and shifts in the economic market. The following areas of flexibility will be reviewed as part of subsequent permits:

- Design details such as those in Chapter 7 (parking, curb management plan) and Chapter 8 (office building length, building heights, Key Corner);
- Optional district system per Chapter 9;
- The floor area per Character sub-area within the Master Plan may be adjusted across the project site as a whole if the project substantial complies with the purpose and intent of the Precise Plan, including height limits, setbacks and other standards per Precise Plan Section 3.3.2.4. This may result in less floor area in one character sub-area and more floor area in another character area compared to Tables 5.7.3 and 5.7.4 in this Chapter 5;

- Development standard exceptions outlined in Precise Plan Section 6.2.3;
- Once land is dedicated to the City, the City can elect to shift land uses identified in the Master Plan at City Council discretion (for example, swap Gateway Park and R6).

Any of these modifications would be subject to consistency review and compliance with the Master Plan, Precise Plan, other Existing Approvals per the Development Agreement, and environmental review per CEQA.

Residential

As part of fostering a thriving community, approximately 1,900 new homes are planned to be delivered, clustered around the VTA Middlefield Station and the new Maude Park. Consistent with the goals of the Precise Plan, a diversity of housing types at a range of affordability levels are planned.

The proximity of the development to the light rail station provides context for residential buildings within the Master Plan area to be of higher density and smaller product types, ranging from studios to two- and three-bedroom options. Depending on market conditions, innovative housing products such as co-living or live/work units could be considered as a way to expand housing availability and affordability. In accordance with the Precise Plan, the mix of unit product types will be assessed by city staff during permit entitlements; however, the Master Plan targets maximizing yield to address the current supply shortage while maintaining a focus on product supported by market conditions and responsive to the amenities, including public transit, to be provided within the Master Plan area. It is envisioned that lower density projects with larger units will, as specified in

Table 5.3.1 Proposed unit count

Building	Unit Range	Proposed Floor Area
R1	+/- 400	320,000 GSF
R2	+/- 450	363,000 GSF
R3	+/- 270	263,000 GSF
R4a	+/- 210	190,000 GSF
R4b	+/- 90	95,000 GSF
R5	+/- 310	340,000 GSF
R6	+/- 170	155,000 GSF
Total	Up to 1,900 Units	1,726,000 GSF

Note: Residential GSF listed above excludes above-ground parking or active uses.

Table 5.3.2 Proposed Active Uses

Site Area	Active Use Floor Area
R1-R2	+/- 30,000 GSF
R3-R5	Up to 15,000 GSF
Ellis Park	Up to 1,000 GSF
P2	Up to 4,000 GSF
Total	Up to 50,000 GSF

LAND USE

the Precise Plan, be delivered in the Whisman Road Transition Area.

The MPMP will target a mix of rental and ownership residential units. Initial residential phases will deliver multi-family rental accommodation to address immediate housing needs, with ownership units targeted for later phases. The ultimate delivery of ownership units, however, will be determined by market conditions. The project will therefore be condo mapped to allow for such future flexibility in ownership structures. Regardless of the ownership status of the units in later phases of the project, the public realm and community building investments made in the earlier phases of the project will create intrinsic place value for the units in later phases. See Table 5.3.1 for proposed unit counts. Residential floor area above Base FAR is proposed,

via the Bonus FAR program. For more information see Section 5.7.

Active uses

Active ground floor uses are an essential part of a land use mix that fosters the growth of community in East Whisman, and is central to the goals of the EWPP. At Middlefield Park, these uses are grouped together as Active Uses. Active Uses are located at the ground level of buildings with programming that generates pedestrian activity. These uses may be retail, neighborhood, commercial, educational, arts, cultural, civic, community or institutional in nature. Examples include, but are not limited to, food and beverage, grocery stores, personal services, retail, day care centers, libraries, museums, indoor fitness, medical services, nonprofit and small-format offices and art studios. Other uses not named, but similar to listed uses and consistent with the

purpose and intent of the Precise Plan such as entertainment venues, co-working spaces, and startup incubators could be allowed pursuant to evaluation at the time of zoning approvals. By providing a diverse mix of uses in strategic locations throughout the master plan, the daily needs of residents can be met in a way that encourages engagement, interaction, and social and community activity that will help form a self-sustaining neighborhood.

With regard to the EWPP’s allowed Land Uses (Table 5, pp. 54-55) Active Use aligns to a number of permitted and provisionally permitted uses, see the proposed Active Use Types in Section B of the Implementation Plan. Active Uses are clustered primarily around the VTA Middlefield Station including near the corner of Ellis Street and Middlefield Road as required in the Precise Plan, with smaller areas reserved around the edges

Table 5.3.3 Proposed open space areas

	Land Dedicated to City	Privately Owned, Publicly Accessible (POPA)	Other Accessible Open Space	Total
Maude Park	5.11 ac	-	-	5.11 ac
Bridge Open Space	1.36 ac	-	-	1.36 ac
Gateway Park	0.50 ac	-	-	0.50 ac
Ellis Park	-	2.87 ac	-	2.87 ac
Other Open Space	-	-	2.92 ac	2.92 ac
Totals	6.97 ac	2.87 ac	2.92 ac	12.76 ac

Note: Total acreages shown represent maximums and are subject to further refinement in future permit entitlements.

Table 5.3.4 Proposed office area

Building	GSF
01	441,939 GSF
02	190,000 GSF
03	310,000 GSF
04	292,212 GSF
05	82,849 GSF
Total	1,317,000 GSF

of Maude Park. Space for Active Uses is strategically aggregated to increase interaction and activation at community and transit nodes. See Table 5.3.3 for proposed retail and community space land use areas. In order to best respond to changing community needs over time, the exact size and configuration of Active Use spaces will be determined during future permit entitlement processes.

Open space

The open space will be the most significant character-defining feature of the Middlefield Park Project, and presents a unified landscape experience from one end of the district to the other. It acts as social infrastructure, providing opportunities for social engagement, cultural expression and interaction, as well as linkages to the surrounding

neighborhoods. More than 12 acres of publicly accessible open space, located along the Ellis Street side of the site and at the core of the Maude Avenue side of the site, will provide a comprehensive variety of recreational opportunities and public amenities; approximately 6.97 acres of dedicated public open space, and approximately 2.87 acres of Privately Owned Publicly Accessible spaces. Additional privately owned space will also be publicly accessible, including various paseos and greenways totaling approximately 2.92 acres. A description of the open space framework can be found in Section 2.4 of the MPMP and a complete explanation of the design and strategies can be found in Chapter 6 of the MPMP. See Table 5.3.3 for proposed open space areas.

Office

Office uses are proposed along the northern edge of the site, close to anticipated office development in the Northern Employment Character Area of the Precise Plan. This location is close to the VTA Middlefield Station as well as adjacent to the Hetch Hetchy bike connections and existing public and private bus stops, allowing for a multiplicity of commuting options. Clustering the office space further allows for more efficient operations, and reduces areas where buffers may be required to maintain a harmonious relationship. Office floor area above Base FAR is proposed via the Bonus FAR program; see Section 5.7 for more detail. See Table 5.3.4 for proposed areas.

Parking

In support of larger Precise Plan goals, the land use plan is oriented towards a reduction of driving as a mode of transportation. Accordingly, the parking provided will be notably less than the allowed maximum ratios; however, minimum ratios for accessibility and EV chargers will be provided. The Master Plan includes the potential for shared parking between complementary retail, open space, office, and residential uses. Carshare and loading spaces are in addition to the land use ratio types identified in the EWPP. The Master Plan includes the potential for reduced off-street loading spaces for non-residential uses. The number of residential loading spaces will be determined by the

5.4 Ground floor uses

District vision

To create a vibrant, connected place, the Master Plan envisions a wide range of ground floor uses across the site. Such a blend will invite activation and interaction among residents and workers, setting the stage for a rich tapestry of place and experience. These uses further inform the relationship of buildings to public spaces, streets and parks. The Master Plan prioritizes transparency, engagement and socializing in locations where retail and other active uses will be successful and will create the highest quality environment.

Priority frontages and ground floor activation

The Master Plan identifies areas that are the highest priority for ground floor activation, as well as those that are not. Including a mix of active and non-active building frontages in the Plan area will help to ensure a healthy balance of ground floor uses. It will also create a more dynamic public realm by offering pockets of both energy and engagement as well as privacy and reprieve within the Master Plan area.

Active frontages are those that are public and permeable. Examples of ground floor uses and treatments that support active frontages include restaurants and cafes with outdoor dining and indoor/outdoor markets, retail, as well as health and beauty service providers, community

and event spaces. Such uses result in a ground floor and adjacent public realm from which people are constantly coming and going, therefore activating the frontage and adjacent spaces. These types of active frontages are envisioned near transit hubs as well as along many of the Master Plan's parks and plazas as well as at key corners.

While there is a spectrum of activation possible for various building frontages, non-active frontages are generally those that are more private in nature. Examples of ground floor uses and treatments that result in non-active frontages include residential stoops, residential patios, and private office spaces. These types of non-active frontages are envisioned further away from key corners and transit hubs and along residential streets and paseos as well as within office clusters.

Note that "active frontages," as described in this section, do not necessarily directly correlate with the "Active Uses" land use type. See Figure 5.4.2 for the conceptual ground floor activation strategy for locations of frontage types.

Active Priority Frontages

Active Priority Frontages are at all Key Corners and retail storefronts, as well as community space use frontages where transparency and engagement are desired. Along Middlefield Road and Ellis Street, the Master Plan proposes commercial spaces in support of the Precise Plan's vision to create complete neighborhoods. Associated with this are ground floor uses that are related to the residential functions of the buildings such as building lobbies, mail rooms, fitness rooms, and leasing offices.

Along the VTA corridor, the Master Plan envisions buildings engaging with adjacent open spaces. At Ellis Plaza, ground floor uses will be flexibly designed to accommodate a variety of retail and service uses. To the extent possible, residential functions such as lobbies, fitness rooms, egress stairs, etc., will be located off of the plaza. Along the linear park further north, ground floor uses will contain a mix of retail and community space uses with some adaptable residential frontages. Community space uses such as a community center, library, or daycare could be appropriate, as their function supports the development of a complete community. The eastern frontage of R2 may contain portions of Non-Active Priority frontage, depending on final programming.

East of the VTA corridor, active frontages are envisioned for residential entries, at the Key Corner at Logue and Maude Avenues, and along commercial and community space frontages. The active frontage on the north side of R4b is flexible in location along that block, in order to improve functionality based on building design. Offices would have active frontages at entries and potentially along open spaces, depending on final programming.

Non-Active Frontages

Non-Active Priority Frontages are being considered along non-Key Corner residential and office frontages. Included are portions of the residential buildings along Ellis Street which are not Active Frontage, including residential units with their associated private

stoops. The Ellis office building, with the exception of its Key Corner entry, will be a non-active frontage, though certain areas could offer more transparency, depending on final programming.

East of the VTA corridor in the Medium Intensity character area, the Master Plan envisions wider landscape buffers to ground floor uses to reflect the reduction in heights and density. Office buildings would have non-active frontages along Logue Avenue, Clyde Avenue and the Neighborhood Park except as noted in Figure 5.4.1. Residential buildings would feature ground floor units with stoops and private gardens. Access to parking and refuse storage would occur on facades facing service streets.

Other Active Frontages

The Master Plan also envisions several structures in open spaces housing community uses which will provide shelter from the elements: places to congregate and socialize adjacent to companion outdoor spaces. These frontages should function as Active Priority Frontages where possible, considering the need for some storage or loading areas. In Ellis Park these may include small pavilions for community uses such as a community center, library, and daycare, as well as spaces for special events.

In addition, the Master Plan envisions two additional Key Corners beyond those envisioned in the EWPP to acknowledge entry into the district along Maude Avenue from Sunnyvale.

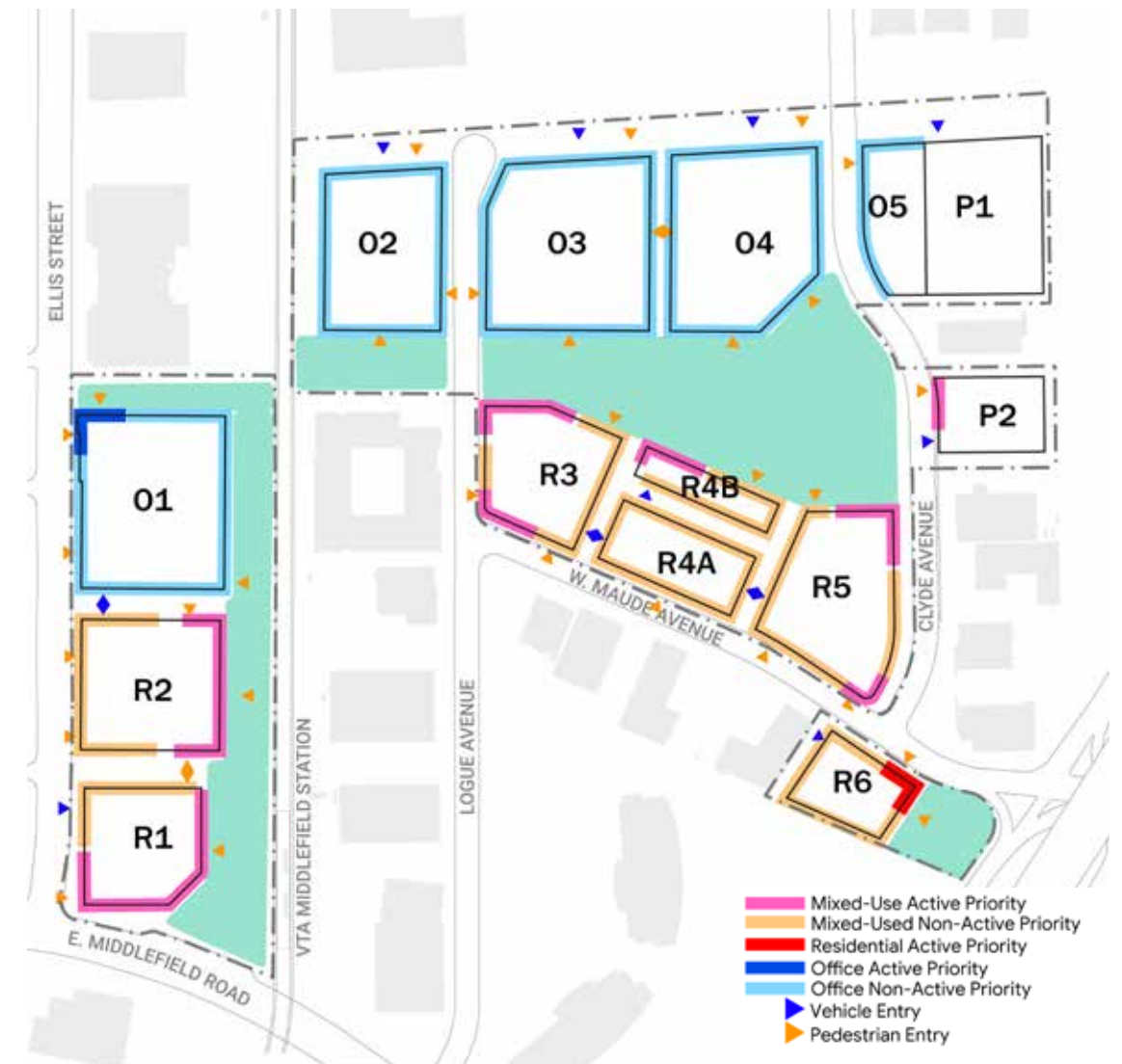

Figure 5.4.1 Conceptual ground floor activation strategy

LAND USE

Both Key corners would be located at the intersection of Maude Avenue and Clyde Avenue (to be considered at future permit entitlements). If approved, the Key Corner will require Active Priority Frontages at R5 and R6.

Potential Middlefield Park neighborhood services:

- Market with fresh produce;
- Family-oriented restaurants;
- Fast-casual dining;
- Neighborhood pub and specialty wine/beer store;
- Medical services and/or drugstore;
- Health and fitness facilities;
- Laundry and/or dry cleaning;
- Personal services.



Figure 5.4.2 Examples of neighborhood-serving uses

5.5 Jobs-Housing Linkage Plan

As an office development requesting Bonus FAR from the Development Reserve, the Project is required to submit a Jobs-Housing Linkage Plan per the EWPP. The Project intends to facilitate new housing in East Whisman by incorporating it as a core element of the proposed development, in proportion to the amount of office being proposed. Middlefield Park's Jobs/Housing Linkage Plan proposes to facilitate the delivery of housing through direct construction of residential units and the dedication of land for affordable housing.

The ratio of three residential units delivered shall be linked to 1,000 square feet of net new office delivered to ensure a balance of new jobs and housing, to support this central EWPP goal. Although the jobs-housing linkage ratio for this project would require 1897 units based on the current office development assumptions, up to 1,900 units are currently proposed.

The entire project is to be implemented with a phasing strategy compliant with the Jobs-Housing Linkage Program. As the Project is built out, it will deliver significant benefits, both through its Community Benefits program and its valuable fiscal contributions. East Whisman will be the focus of both physical and social infrastructure investments for years to come. Further details on Jobs-Housing Linkage Plan compliance is located in the Development Agreement.

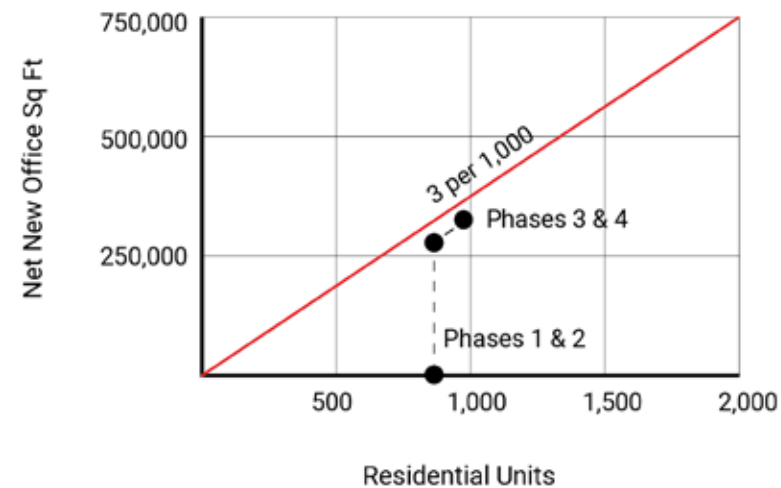
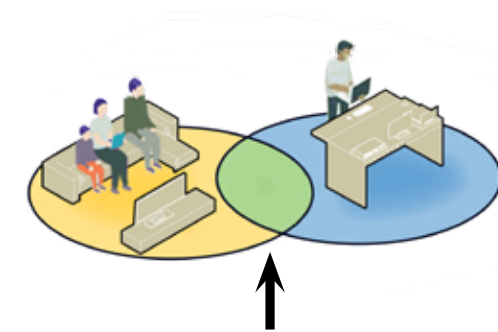

Figure 5.5.1 Jobs-Housing Linkage phasing

Up to 1.726M sf of resi
Up to 1,897 units/~4,000 residents



Up to 1.317M sf Office

Maximizing the value of shared amenity for Google and the broader community

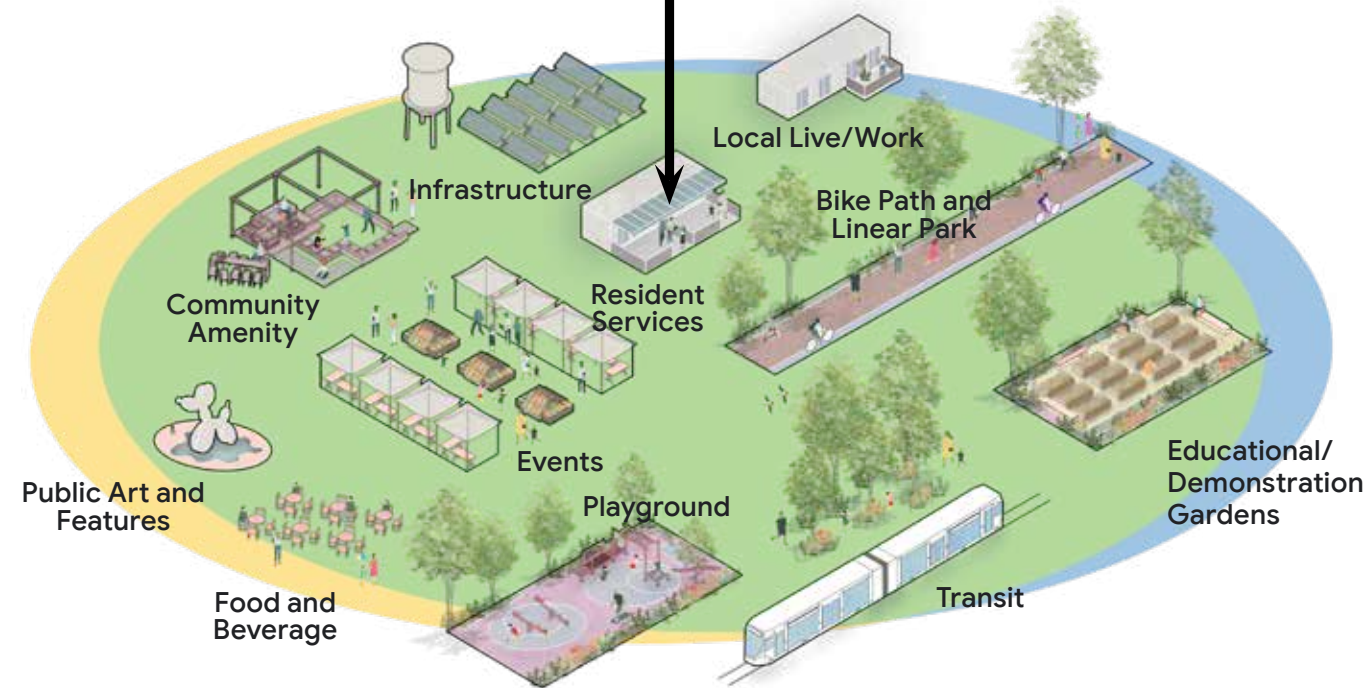

Figure 5.5.2 Jobs-Housing Linkage plan

5.6 Affordable housing

The East Whisman Precise Plan envisions diverse housing to serve mixed-income levels. It establishes a goal of 20 percent affordable housing across the plan area through 15 percent inclusionary below-market rate units and incentives for production of 5 percent additional below-market rate units.

The City of Mountain View’s Below Market Rate Housing Program (Chapter 36, Article XIV of the City Code) requirement for rental units calls for affordability targeted to households with incomes ranging from 50 percent area median income (AMI) to 120 percent AMI, with a weighted average of up to 65 percent AMI between a minimum of two income levels, and with higher averages for ownership units. The code also

offers alternative approaches to support increased affordable housing production.

The Middlefield Park Master Plan seeks to deliver a diverse housing vision in alignment with the East Whisman Precise Plan, and exceed the City code requirement by targeting 20 percent affordable housing within the Master Plan Area.

In order to maximize the number of affordable housing units delivered at Middlefield Park, we propose an alternative mitigation strategy that utilizes land dedication within the Master Plan area. The Alternative Mitigation, per the City’s BMR regulations, is to dedicate 2.40 acres (R4a and R6) to the City for development of approximately

380 units of affordable housing by affordable housing developer(s).

When considered against other potential strategies, dedicating land for an affordable housing provider to develop is likely to enable more residents to receive the benefit from the Master Plan’s affordable component. See the Project’s Affordable Housing Proposal in the Implementation Plan for more information.

5.7 Bonus floor area ratio

Middlefield Park’s development program proposes to entitle gross floor area beyond the Base floor area ratio (FAR) maximum in compliance with the Bonus FAR program described in the Precise Plan. The Project requests new office square footage from the Development Reserve in return for the provision of community benefits, a Jobs-Housing Linkage Program, affordable housing, and the inclusion of green building standards, all as described elsewhere in this document.

The Bonus FAR program contemplates a Development Reserve that allows additional office gross square footages in exchange for implementing key projects and policy goals of the Precise Plan. See Table 5.7.2 for more information.

Bonus FAR calculation

Office entitlement requests Bonus FAR in three different Character Sub-Areas (see Table 5.7.3) while residential and mixed-use entitlement requests Bonus FAR in only one Character Area (See Table 5.7.4). The Base and Bonus FAR entitlements are shown graphically by tier in Figure 5.7.1

FAR exemptions

Section 3.3.2.5 of the Precise Plan allows floor area to be exempt from allowable FAR that is provided for; (a) small businesses or educational, cultural, or other nonprofit uses (up to a maximum of 5 percent of the gross floor area); and space for neighborhood commercial uses. These spaces are not exempt from other development standards or bonus

FAR requirements unless otherwise noted in the Development Agreement.

All qualifying 50,000 square feet of Active Use space is exempt from floor area with execution of a legal agreement recorded on each respective property identifying the approved building gross floor area exemption (location, square footage) and use of the space for a qualified business or organization per the EWPP. Additionally, if pursued, the Central Utility Plant for the District System is exempt from FAR. Actual FAR includes these FAR exemptions.

Should an Active Use not qualify for an FAR exemption, the Total FAR per subarea is listed below each graphical tier. If not exempt from

FAR, these Active Use spaces are not subject to community benefit obligations beyond those approved in the Development Agreement, but may require modifications to a previously-recorded agreement on the property for the FAR exemption. Total FAR includes no FAR exemptions and includes the Central Utility Plant in the High Intensity Mixed Use subarea.

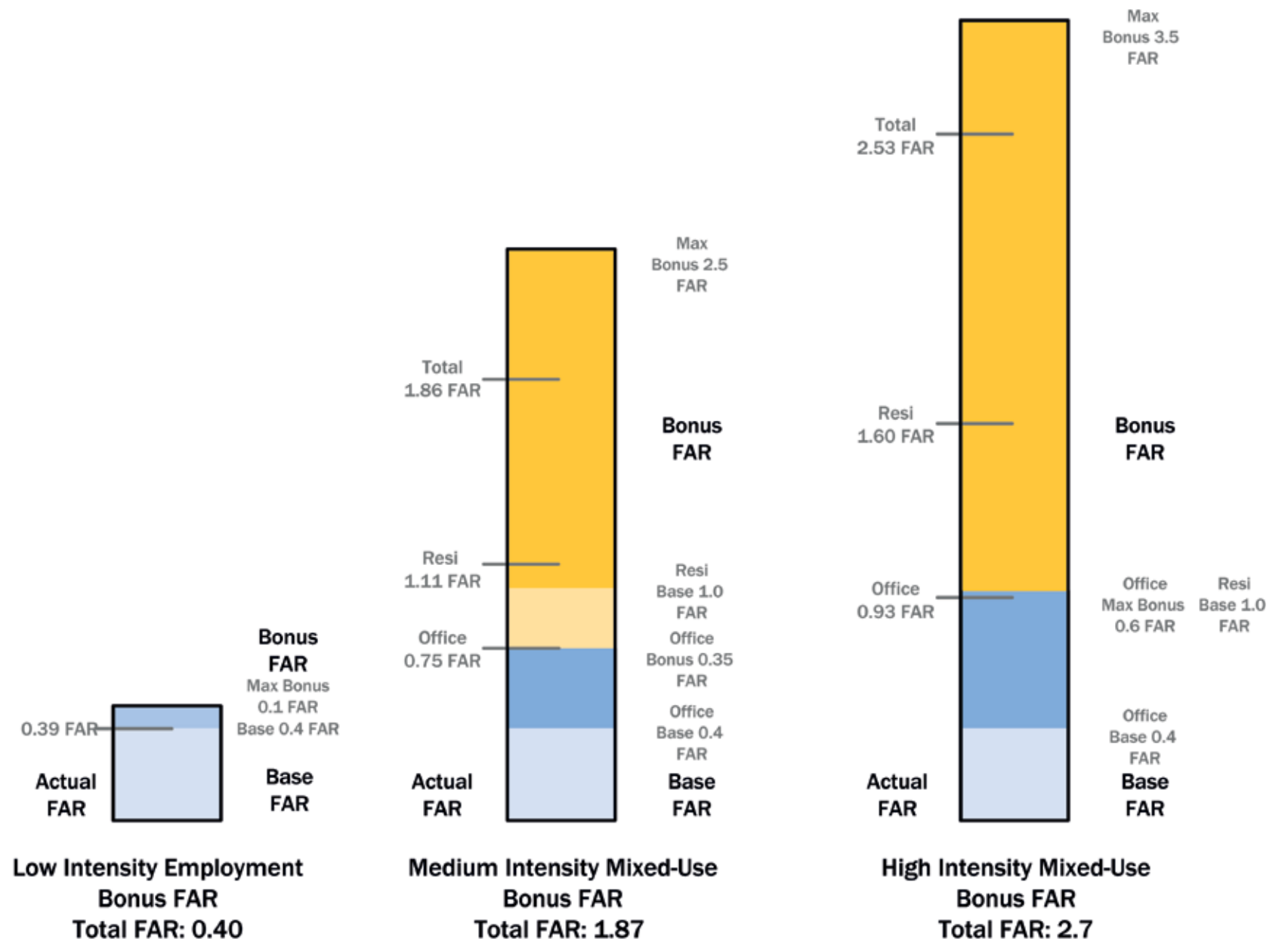

Figure 5.7.1 EWPP Bonus FAR tiers

LAND USE

Table 5.7.2 Development Reserve entitlement				
Land use	Existing	Net new	Total	Required residential units
Development Reserve office	-	632,354 GSF	-	1,897
Set-Aside office	-	-	-	-
Totals	684,646 GSF	632,354 GSF	1,317,000 GSF	1,897

Table 5.7.3 Proposed office FAR							
Character Area	Site area	Base FAR	Base FAR sf	Bonus FAR	Bonus FAR sf	Total FAR	Total building sf
Mixed-Use – High Intensity	472,759 GSF	0.4	189,104 GSF	0.53	252,835 GSF	0.93	441,939 GSF
Mixed-Use – Medium Intensity*	1,055,304 GSF	0.4	422,122 GSF	0.35	370,090 GSF	0.75	792,212 GSF
Employment Area – Low Intensity	212,129 GSF	0.4	82,849 GSF	0	0	0.39	82,849 GSF
Total	1,740,193 GSF		694,075 GSF		622,925 GSF		1,317,000 GSF

Table 5.7.4 Proposed residential/mixed-use FAR							
Character Area	Site area	Base FAR	Base FAR sf	Bonus FAR	Bonus FAR sf	Total FAR	Total building sf
High Intensity Mixed-Use	472,759 GSF	1.0	472,759 GSF	0.60	285,241 GSF	1.60	758,000 GSF
Medium Intensity Mixed-Use*	1,055,304 GSF	1.0	1,055,034 GSF	0.11	112,695 GSF	1.11	1,168,000 GSF
Total	1,528,064 GSF		1,528,064 GSF		397,936 GSF		1,926,000 GSF

*Includes increased project site area for FAR calculations.

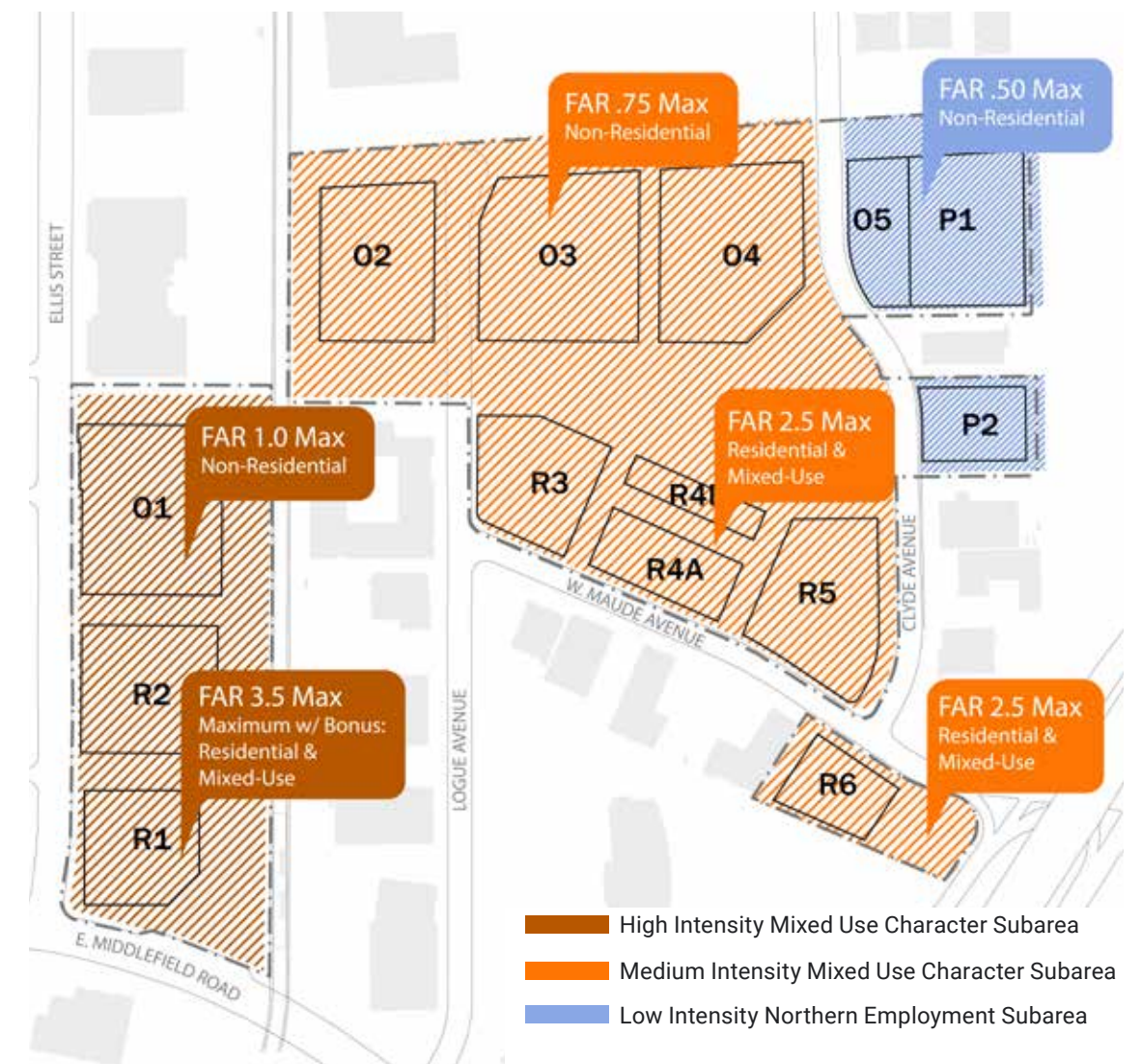

Figure 5.7.5 Middlefield Park FAR by character area

6. OPEN SPACE

The MPMP proposes to transform an urban landscape with few parks and little greenspace or tree canopy into a vibrant ecological oasis with a variety of open space opportunities.

6.1 Open space approach

Occupying the Santa Clara Valley's rich alluvial soils and benefiting from high groundwater levels, Middlefield Park has the potential to revitalize the local landscape, re-integrating the grand oak savannas, lush forests, and flower-filled meadows that occurred at the site before development. The Project seeks to bring back missing elements of the Valley's natural heritage, and create an ecological node that enhances connection to nature and biodiversity while contributing to adjacent ecological features such as the Sunnyvale Municipal Golf Course and Stevens Creek.

The open space will be the most significant character-defining feature of the Middlefield Park project, and presents a unified landscape experience from one end of the district to the other. It acts as a commons, providing opportunities for social engagement, cultural expression and interaction, as well as linkages to the surrounding neighborhoods. While the final design and programming of the dedicated parkland is to be determined by the City of Mountain View, this chapter offers a vision for this unified system on private land.

The Project's diverse open spaces system will be carefully integrated with the ground-floor and massing strategies of the blocks and buildings to create delightful, welcoming, and active places. The unique character and programs will attract visitors and create a lively network of well-

loved public spaces for East Whisman and Greater Mountain View.

Large-scale ecologically beneficial area improvements will be defined and connected by an expansive tree canopy and understory planting. The understory is the layer of small trees, shrubs and groundcover plants that grow closer to the ground below the tree canopy. Google's own local tree farm, which focuses on growing native species, may supply some of the trees and shrubs that are planted.

By designing the open space as an ecological network that connects to surrounding ecological features, the MPMP maximizes both the contribution to local biodiversity, and the health, human experience, and biophilia benefits that accrue to the local community as a result.



Figure 6.1.1 Open space character images

Open space principles

- Design for people;
- Restore and enhance locally native ecological communities;
- Optimize for human health, safety, comfort, happiness, and productivity;
- Create a sense of place for 24/7 activity with a variety of highly-connected pathways and publicly accessible amenities;
- Provide for active mobility away from vehicular streets.



Figure 6.1.2 Open space key plan

- Dedicated public space
- Privately owned public space
- Private open space
- Middlefield Park boundary



Figure 6.1.3 Open space concept

OPEN SPACE

Open space sustainability

Goals and best practices for sustainable landscape development are fully integrated into all aspects of the Master Plan. Four fundamental themes— Community, Ecology, Wellness and Resource use— organize the Master Plan’s open space sustainability strategy and are integral to East Whisman’s sustainability:

Community:

- A variety of outdoor spaces, activities and amenities for social and community interaction;
- Something for everyone, of all ages; intergenerational engagement;
- Educational/demonstration garden;
- Opportunities to cultivate and steward the landscape.

Ecology:

- The site will be covered with a tree canopy that includes existing trees as well as trees planted as part of the project that will mature. This robust tree canopy will be combined with understory planting and together, the over- and understory of the urban forest will provide significant urban ecological areas across the project site;
- Variety of plant communities designed to support resident and migratory birds, pollinators, and other native wildlife;
- Prioritize using a diversity of primarily native plant species that enhances existing biodiversity and foster a resilient landscape;
- Implement bird-safe design guidelines for all new construction;
- Use site lighting optimized for low energy use and dark skies while maintaining pedestrian safety.

Wellness:

- Active mobility in a vehicle-free environment, centered on access to mass transit;
- Immediate access to beauty and nature supports community health and biophilia;
- A balance of active recreation and restorative, contemplative spaces;
- Improved air quality as vehicle emissions are reduced while new trees help remove pollutant particles from the air;
- Reduced heat island effect and enhanced outdoor thermal comfort.

Resource use:

- Low water, drought-tolerant plant species and reclaimed water for irrigation;
- Detention and treatment of stormwater run-off on-site in vegetated swales and basins;
- Carbon sequestration through landscape design;
- Use of materials with low embodied carbon in public realm.

Carbon reduction through open space design

Best practices for carbon reduction are incorporated into the Middlefield Park Master Plan with a goal of sequestering more carbon than emitted in the landscape over the life of the project.

The three primary factors to consider when improving the carbon footprint of the landscape are reduction of embodied carbon from material production and transport; increase of carbon sequestration (storage) in plants and soil; and the reduction of ongoing operational carbon emissions from maintenance or site disturbance.

By implementing the following guidelines, the Master Plan seeks to set a high level framework for voluntarily making a positive contribution to climate change:

Reduce embodied carbon:

- Minimize paving and material use;
- Use materials with lower embodied carbon such as wood – typically the more natural the better;
- Reuse materials from the site (wood from fallen trees, rocks etc.);
- Use local materials;
- Maximize cement substitutions in concrete – slag, flyash, glass pozzolan or silica fume are examples;
- Use organic or eco-friendly binders in materials like stabilized crushed stone paving;
- Specify materials with a high percentage of recycled content;
- Design natural drainage like swales to reduce piping.

Increase carbon sequestration:

- Minimize the removal of existing trees;
- Maximize space devoted to planting of all kinds;
- Within planting areas, decrease spacing between plants by using species that will thrive together in layered conditions (i.e. a natural forest condition);
- Select native or regionally adapted grass species for lawn areas;
- If trees must be removed, consider re-using the wood in buildings, as site furnishings, or sending to a biochar facility.

Reduce operational carbon emissions:

- Minimize soil disturbance to prevent soil carbon release;
- During construction, consider using a cover crop on disturbed soils that will be exposed for an extended length of time;
- Amend soil in place rather than importing new soil;
- Specify organic fertilizers;
- Create an Operations and Maintenance Manual to ensure best practices are followed over time;
- Select plants that require low maintenance;
- Consider use of locally-produced biochar produced from biosolids to amend soils and store carbon and support a circular economy;
- Minimize amount of high maintenance turf and use no-mow grasses or meadows instead.

6.2 Open space network

A connected sequence of open spaces

The publicly accessible open spaces of Middlefield Park connect through and across the site to provide valuable linkages and amenities to the community. These open spaces are provided in dedicated public spaces and in private but publicly accessible spaces.

Ellis Park is an open space providing north-south access and community programming along the west side of the VTA tracks. At the south end of Ellis Park at East Middlefield Road is Ellis Plaza, which provides the district with an entry point and urban core.

Ellis Walk extends north from the plaza and provides a programmed promenade connecting through the district to Bridge Open Space.

Bridge Open Space is envisioned to include a future ped-bike bridge (to be designed and constructed by the City) over the VTA tracks, offering connectivity across all of East Whisman, and linking the two sides of the open space network.

Maude Park is the core dedicated public space connecting from Logue Avenue to Clyde Avenue.

Gateway Park is a dedicated public park at the corner of West Maude Avenue and SR 237.

Note: The the linear park originally envisioned for this site in the EWPP (directly south of the SFPUC right-of-way) has been relocated to expand the scale of Bridge Open Space and Maude Park.



Figure 6.2.1 Open space plan

6.3 Open space programming

A journey with multiple destinations

A diversity of open spaces and amenities create opportunities for residents to have a sense of purpose — a place where they can craft, build, learn from, play in and own their environment. Various distinct open space areas accommodate a wide variety of physical activities and social pursuits to be a part of everyday life in Middlefield Park. The Master Plan proposes a new series of open spaces in East Whisman. These spaces should highlight local ecology and provide new places for workers and neighbors to convene. Activity nodes are created by bringing retail experiences and common space to the buildings at street level.

The character of Middlefield Park’s outdoor environment shifts from a more urban intensity on Ellis (red) to a larger-scale setting at Maude Avenue (blue)(Figure 6.3.1). A plaza at Ellis Street and a large, mixed recreational area off of Maude Avenue bookend

and anchor the Middlefield Park open spaces. The multi-use path in Ellis Park functions as bicycle and pedestrian corridors, connecting all open spaces across the neighborhood and beyond. A journey is available to pedestrians and cyclists that transitions from the active and lively light rail station to the future setting of Maude Park, which could have a mix of recreational activities.

Parks and plazas may include site furnishings such as benches, bicycle racks, and trash receptacles, as well as site lighting and small structures to serve the programmatic, service, and storage functions associated with public use of every part of the open space network.

Potential outdoor programming for Ellis Park includes: dining; growing food and flowers; exercise and play; space that accommodates making, selling, and gathering; and places for small groups and individuals to commune with nature. Program opportunities and



Figure 6.3.1 Key open spaces

amenities shall serve a variety of users ranging in age, health, and interests. Indoor multipurpose spaces and small independent structures in the open space, characterized as Fairchild Barns (inspired by local history, also referred to as Ellis Community Pavilion), will provide flexible places for community uses such as birthday parties, quinceañeras, local “town hall” events, and more.



Figure 6.3.2 Potential programming

6.4 Green connections

The MPMP proposes an accessible, interconnected network of open spaces for the benefit of the East Whisman community: connected to one another, to the neighborhood, and to the rest of Mountain View, and accessible by transit and bicycle. A comprehensive network of off-street circulation ensures universal access to all public open space in Middlefield Park. Active mobility is encouraged by the landscape setting of all paths, while the interconnection between open space and path networks creates shaded pedestrian routes.

Pathways combine in loops for exercise, jogging, or walking meetings for people of all ages. Primary circulation across the site is provided by wide, universally accessible paths that efficiently integrate required emergency vehicle access (EVA) as necessary. These wider paths accommodate pedestrians, bicycles, and micro-mobility.

Smaller paths provide pedestrian circulation through the open spaces, with the narrowest paths affording access to the most heavily planted areas of the landscape as garden walks.

A series of north-south publicly-accessible paseos are proposed between the buildings and Maude Park in lieu of the north-south vehicular Street C recommended in the EWPP.

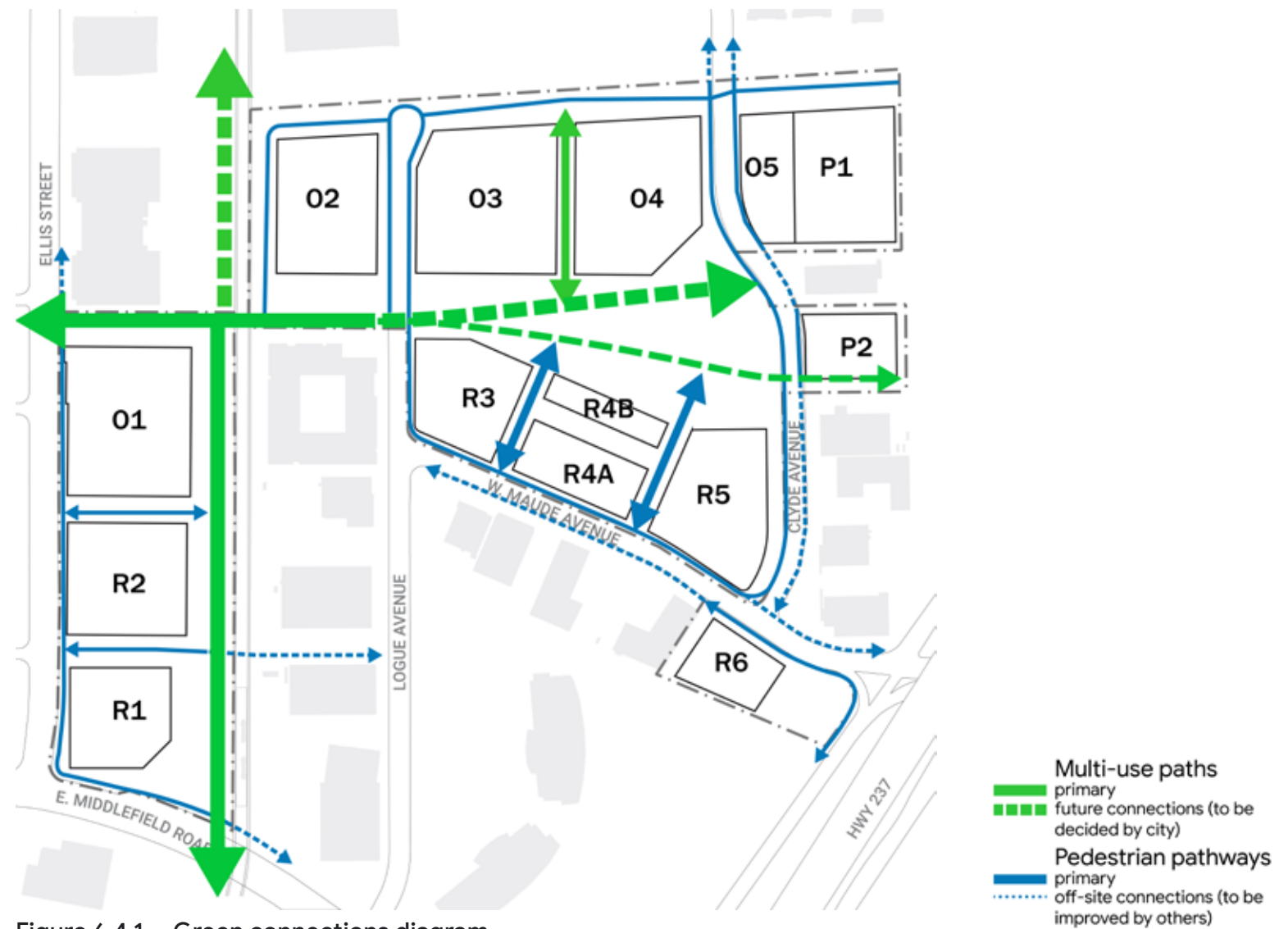

Figure 6.4.1 Green connections diagram

6.5 Ecological function and experience

Middlefield Park’s open space will be an environment designed for the health of native plant and animal communities. The open space design of the Project is an opportunity to begin healing the damage done by decades of manufacturing and single-use zoning. The Project aspires to transform an area extremely limited in both tree canopy and access to nature into a model for integrating nature into a dynamic urban landscape.

This design approach is also intended to improve human health. It draws on research that demonstrates the importance of high-quality outdoor nature experiences, from small daily interactions provided by urban greening features (e.g., stormwater features, plazas) to deeper, immersive experiences provided by larger urban nature nodes.

Improving the ecological fabric of the site is critical to helping build resilience in the face of climate change. A network of landscapes and connected tree

canopy will decrease heat stress, sequester and store carbon, and reduce the risk of flooding during storm events. The open space network is characterized by diverse and plentiful native and climate-appropriate plantings with high value for wildlife. Users will be able to walk through distinctive native plant communities and ecotypes, from the lush canopies of cottonwoods and big leaf maples to dramatic oak savannas to the sunny floral displays of pollinator meadow lands. Landscaping design will be compliant with sight distance requirements for intersections.

Ecological opportunities

Based on its location and surrounding context, Maude Park represents an opportunity to establish greater ecological connectivity throughout the site as well as to adjacent open space areas, such as the Sunnyvale Municipal Golf Course, Stevens Creek, and the SFPUC pipeline corridor.



Figure 6.5.1 Ecological connections

- Ecological corridor
- Canopy connection
- Biotreatment areas
- City-dedicated park



Figure 6.5.2 Proposed tree species composition

- Alder mix
- Canyon mix
- High canopy mix
- Oak mix
- Sycamore mix
- Street trees
- City-dedicated land

OPEN SPACE

Ecological typologies

Located on the rich alluvial soils of the Santa Clara Valley and at the interface of diverse historical ecosystems, Middlefield Park has the potential to draw on a diverse suite of locally-native vegetation communities. Native oaks, upland fringes of wetlands, woodland planting areas, flowering meadows, and plaza and streetscapes all contribute to the character of this important open space network. Transforming Middlefield Park into a high-value ecological node will contribute to the biodiversity of the surrounding urban landscape.



Figure 6.5.3 Ecological typologies

- Alder mix
- Canyon mix
- High canopy mix
- Oak + sycamore mix
- Street trees
- Pollinator meadow
- City-dedicated park

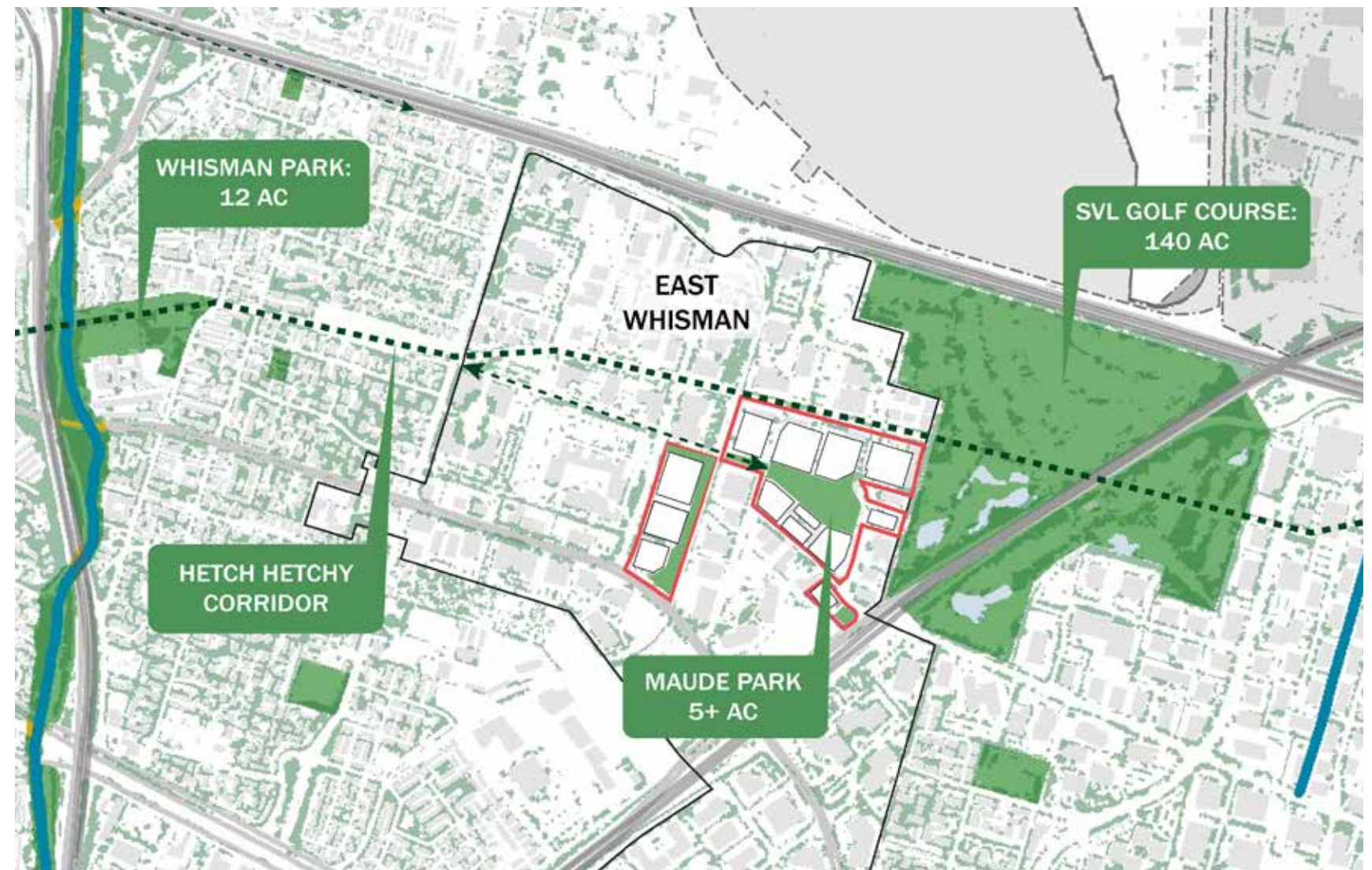

Figure 6.5.4 Contribution of East Whisman to ecological context

Ecological systems

The character of the open space network will be shaped by California native plant communities that are organized in several landscape typologies to create distinctive visitor experiences: meadows, forests, canyons, and connected street tree canopies. Based on native ecosystems that have historically occurred in the surrounding region, each of these typologies includes tree and understory species that relate to key ecological enhancements, and facilitate open space programming. Their species composition is tailored to provide high environmental values for birds and insects and to be sustainable in an urban context with heavily altered hydrology and soils and limited planting areas, as well as anticipated climate conditions.

Vegetated stormwater treatment facilities are incorporated throughout the open spaces to treat runoff from structures and paved surfaces. The

Project will include stormwater treatment for new streets and comply with C.3 requirements for new buildings. The Project intends to pursue unlined treatment facilities where possible in order to promote more robust plant growth and stormwater infiltration. Due to high existing groundwater elevations in some of the Project area, some treatment facilities may be lined and their vegetation should contribute to the ecological goals of the Master Plan.

Converting the extensive existing paved surfaces to permeable surfaces and landscapes will reduce peak stormwater events, greatly reducing the impact on hard-piped infrastructure and engineered flood channels located further downstream in the watershed. Vegetated treatment integrated throughout will filter pollutants and hard minerals at the site level, resulting in higher quality stormwater to support a wider ecological network beyond the Project boundary.

Connected canopy

The tree canopy is the most significant structural element in the Project and provides ecological, social, and biophilic benefits. A lush and expansive tree canopy connects the public and private places within the neighborhood, spreading outwards along major access routes and creating a daily connection with nature for workers and residents.

Hundreds of new trees will sequester carbon, deliver critical relief from increasing temperatures, and provide measurable ecological value. Significantly for East Whisman, canopy foliage can filter air-borne diesel particulates blown from surrounding freeways. The connected canopy strategy can contribute to the goals and objectives of the City of Mountain View Community Tree Master Plan through best practices of tree planting and soil health.

Re-oaking the urban landscape

Re-oaking is an approach to integrating native oaks and native oak-dominated ecological communities into developed California landscapes to provide a range of ecosystem functions and services. A network of oaks, typically spaced no more than 75 to 120 feet between trees, will create a functional, connected network for wildlife. The flexibility in spacing of oak communities, including a variety of ages and sizes, allows the trees to be integrated into open spaces and mobility corridors based on wildlife needs and human needs for open space, shade, and biophilic experiences.

Native oaks are expected to adapt readily to the urban environment of the Project area. Measures will be taken to improve soil quality and drainage where existing soils are poor. After initial establishment, little to no irrigation or routine maintenance is anticipated to be required.

Commitment to the successful urban forest will:

- Develop a forest ecology with healthy soils and sequester carbon;
- Reduce the heat island effect and increase residents' well-being;
- Provide opportunity for hands on stewardship and community building;
- Provide an environment for nature education and learning.

6.6 Canopy phasing

The following compositions illustrate the potential canopy coverage of new trees planted over the development phases of the project. Tree layout is illustrative and subject to change and does not account for trees on new City park land.

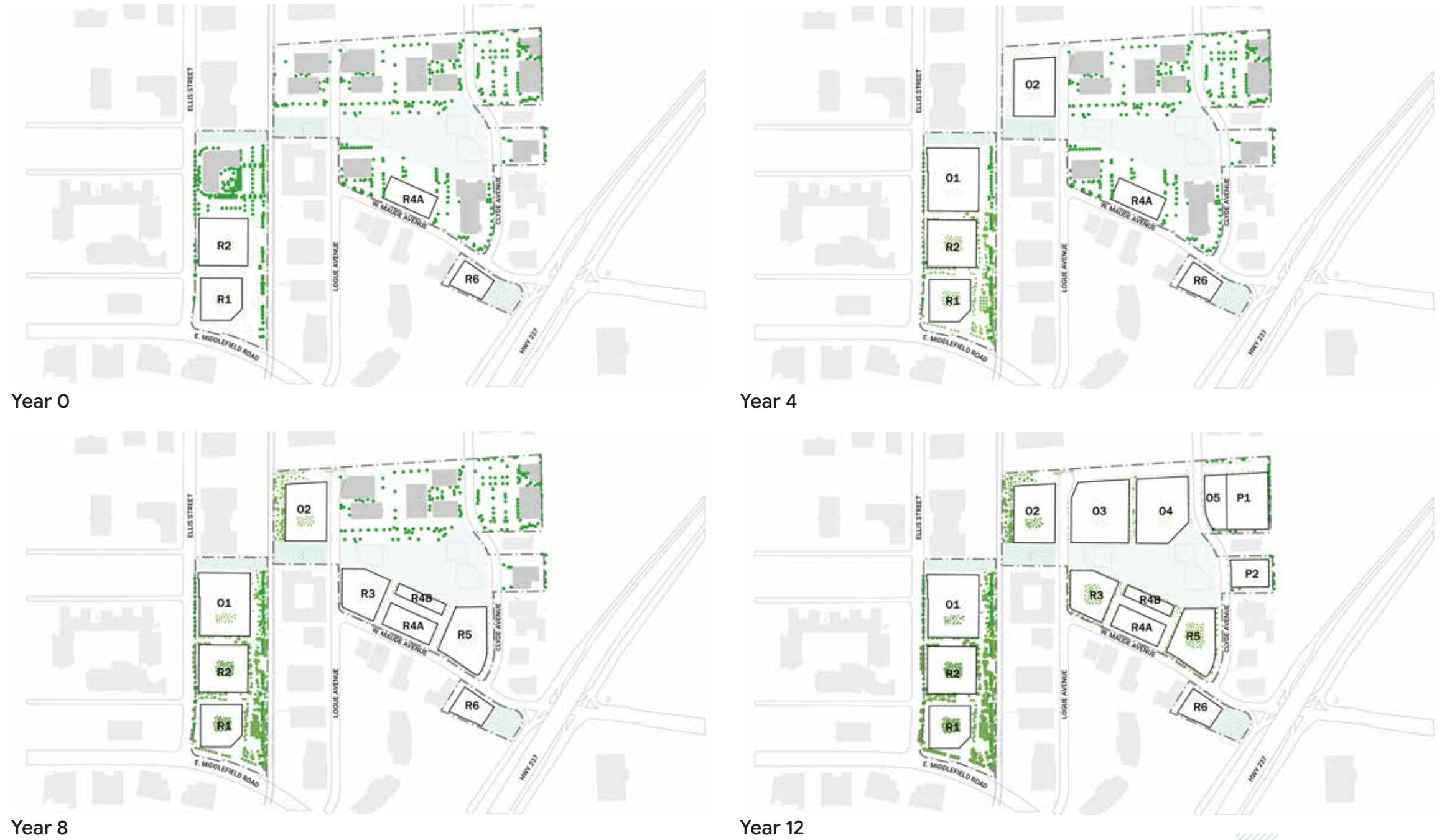

Figure 6.6.1 Canopy phasing diagrams (massing and layout is illustrative and subject to change)



Year 16



Year 20

6.7 Planting

The Master Plan describes an environment that benefits both people and wildlife by incorporating native plant communities throughout the landscape. These ecological enhancements benefit people by creating a more pronounced sense of place, increasing ecological awareness, and improving physical and psychological well-being by providing daily encounters with nature. Wildlife also benefits from increased ecological resources that provide for shelter, nesting, and foraging.

Planting objectives:

- Create ecologically valuable planting areas that will persist and regenerate over time;
- Plan ecological enhancements that will synergistically complement other conservation and restoration plans at a regional level;
- Prioritize the use of native species (which support high wildlife value) in new landscaping to the greatest extent feasible;
- Replace existing trees that are not well suited to the local microclimate or non-native invasive tree species, and trees that do not provide wildlife value;
- Replant any Heritage trees removed per city ordinance;

- Prioritize planting and preserving trees which provide maximum contribution to the tree canopy.

Refer to the Implementation Plan’s Planting Design section for more detailed information.

Benefits of planting objectives:

- Featuring site-appropriate native plants creates a sense of place for human users that fosters ecological awareness and appreciation;
- Using locally native plants helps to protect local ecosystems from invasive species;
- Site-adapted native plants require minimal irrigation due to their adaptation to local climatic patterns and use less water than many non-native species;

- Biophilic benefits are increased by supporting more diverse forms of wildlife that create a more engaging human experience;
- Provide food resources, shelter, nesting, and refuge to native wildlife and beneficial insects;
- Making room for high performance native trees suited to local conditions that are more resilient over time will provide more ecological benefits over the life of the project.

Design aesthetics

The visual aesthetic of native planting areas is generally different than that of conventional manicured landscapes. California native ecological communities are highly seasonal and can be perceived as messy or uncared for, in particular looking overly dry and weedy in late

summer and early fall without human intervention. Designers can soften the more rugged appearance of native planting areas by placing aesthetically pleasing native species in high-use areas and near paths, clustering them densely to mask interior areas of high ecological value that have a rougher appearance. Visual and educational cues can clarify that the native planting area is intentional, special, and cared for.

Tree preservation

Please see the Tree Framework Plan in the accompanying Implementation Plan for information on tree preservation.



Plant species selection principles

Site-appropriate plants should be selected to create ecologically sound areas with high wildlife value.

- Selections will prioritize native species unless there is a compelling reason to include a non-native species without ecological value (for example, specific programmatic goals like edible landscapes, recreation areas, etc.);
- Avoid the use of non-native and invasive plants;
- Avoid or minimize the use of cultivars, as they are less likely to provide the same benefits to wildlife as the pure native species, and may hybridize with native species in the landscape;
- Prioritize water-efficient plant species that compliment the City’s Water Efficient Landscape regulations, and are tolerant of recycled water;

- Plant for seasonality, choosing combinations of species that will provide resources to wildlife throughout the year.

Plant layout principles

Plant layout refers to the arrangement and distribution of plants in a site.

- Strategically place the Project’s largest wildlife-optimized planting areas to maximize connectivity to nearby natural areas;
- Create a diversity of overlapping vertical layers within planting areas;
- Place plants in a way that creates a diversity of plant density within planting areas;
- Space native oaks throughout the landscape to create a network where no oak is typically more than 75-120 feet from its closest neighbor (for more details see: San Francisco

Estuary Institute. (2017). *Re-oaking Silicon Valley: building vibrant cities with nature*. Richmond, CA.);

- Space plants adequately to allow for healthy growth over time;
- Group plants by their water needs to ensure all plants are receiving an appropriate amount of water;
- Choose plants according to microclimatic conditions and program intent;
- Be mindful of plant placement near paths and roads;
- Design for pest prevention;
- Comply with applicable guidelines for bird safe landscape design: and strategically place vegetation to minimize the risk of birds colliding with buildings or other surfaces.

Figure 6.7.1 Planting design precedent images

6.8 Plant palettes

The plant palette is organized by planting zone described in Ecological Typologies, with dominant species composition. See Section H - Planting Design in the Implementation Plan document for more information.



Figure 6.8.1 Ecological Typologies

- Alder mix
- Canyon mix
- High canopy mix
- Oak + sycamore mix
- Street trees
- Pollinator meadow
- City-dedicated park

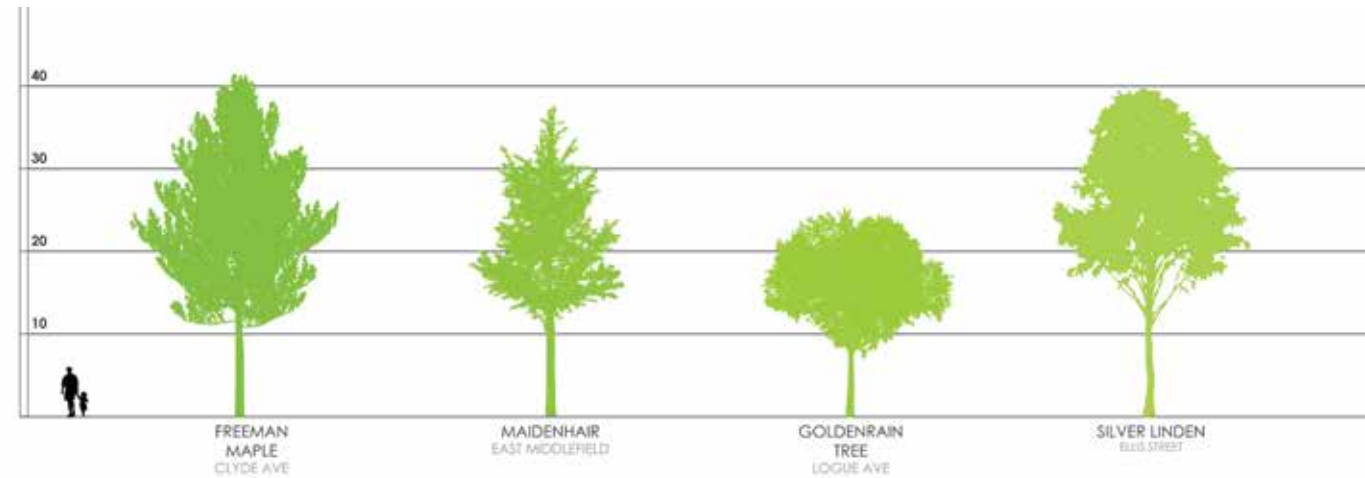

Figure 6.8.2 Street Trees

Street trees

Native species planted along streets extend to the public right-of-way the ecological function, value, and character of the areas described, thereby building a robust network of urban biodiversity that can seed neighboring efforts.

The City of Mountain View City Street Tree Master List identifies these species for the streets adjacent to Middlefield Park: Ellis Street – silver linden; Logue Avenue – goldenrain; East Middlefield Road – maidenhair, Maude Avenue - scarlet oak, Clyde Avenue – freeman maple or black maple. Alternative tree species are requested for the Middlefield Park

Master Plan to extend the ecological framework of the connected canopy to the adjacent streets.

In some cases, it may make sense to retain existing, non-native street trees for reasons such as helping to maintain a mature canopy. Wherever new street trees are needed within the master plan area, Google will coordinate with the City Arborist to either plant species from the adopted Master Street Tree List or obtain approval to select alternative species from a carefully curated palette of trees. Trees will be selected based on street use and exposure to create diverse and appropriate native canopies that provide important benefits such as connected corridors for native wildlife and a strong local sense of place.



For example, large, majestic oaks could shape a strong canopy character along West Maude Avenue. Madrones and other smaller canopy trees can provide a more human scale and traffic-appropriate structure along Ellis Street given its wide and busy lanes and more narrow sidewalk. All of these combined provide for seamless transitions between ecological zones. A continuous native street tree canopy is also both a beneficial connective corridor for a variety of native wildlife and comfortable and enjoyable to pedestrians. Street tree selections will be consistent with the Community Tree Master Plan.

Landscaping design will be compliant with corner and driveway sight distance requirements.

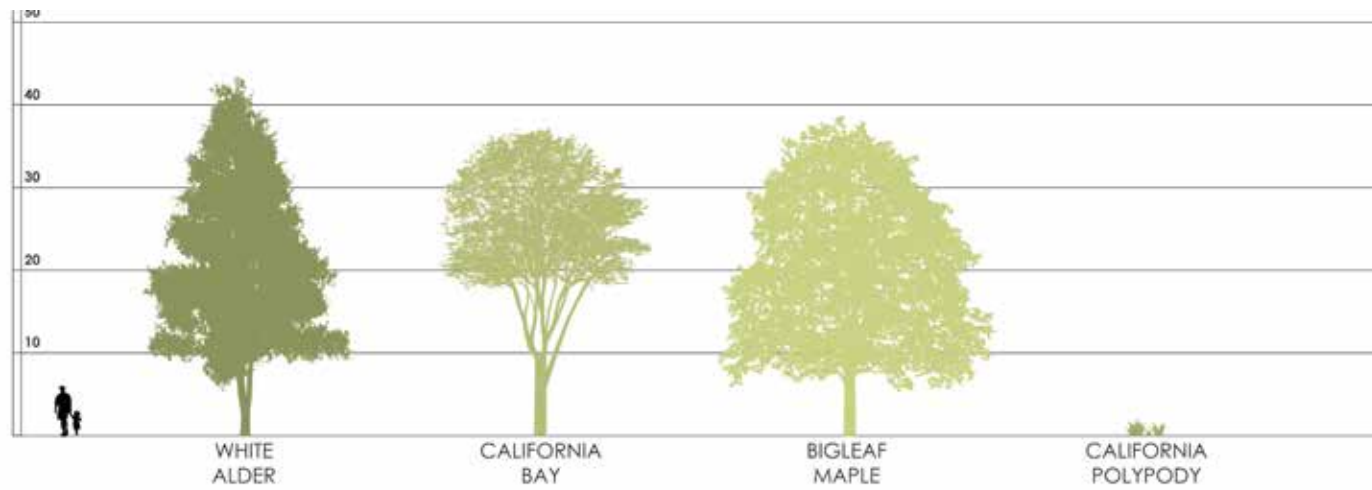

Figure 6.8.3 White alder mix

White alder mix

This mix is dominated by trees such as the fast-growing white alder (*Alnus rhombifolia*), with secondary species of big leaf maple (*Acer macrophyllum*) and California bay (*Umbellularia californica*). It creates a mixed forest transition between the northern boundary and the buildings and more formal programmed areas. These trees can be paired with a range of grasses, ferns, and flowering plants to provide year-round interest to users and host a variety of bird and butterfly species. It is considered a high water usage area – these species are suitable for such places and has good ecological value. This mix should be kept away from any oak species as the California bay tree is a vector for *Phytophthora* species.

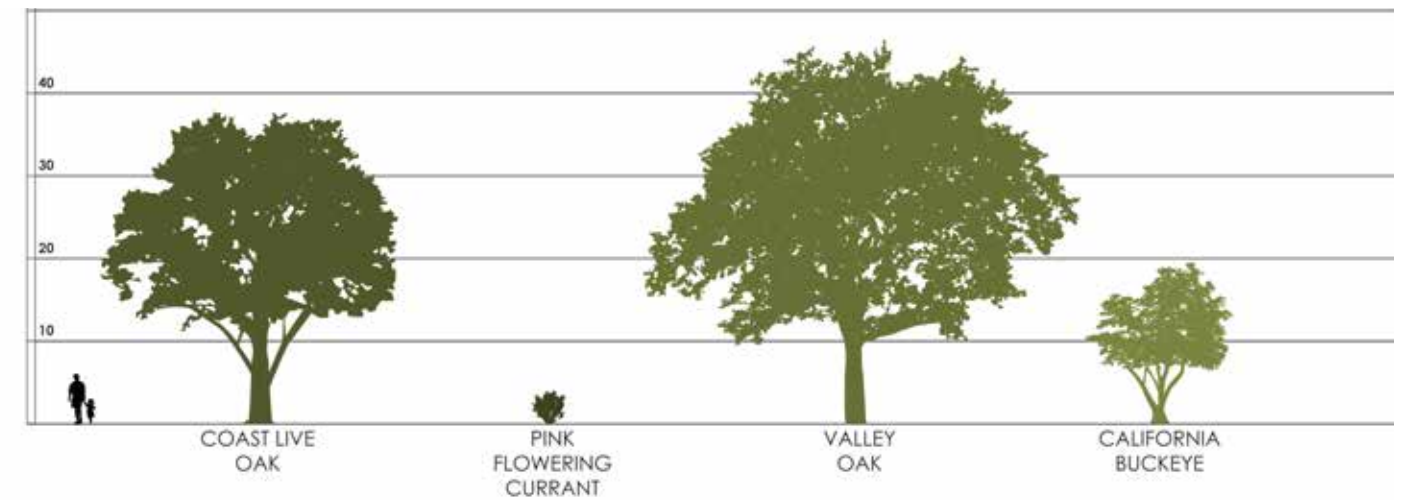

Figure 6.8.4 Oak mix

Oak mix

In immersive open spaces and outdoor rooms, multi-storied oak woodland planting should be implemented to create a sense of transitions and enclosure in a dynamic natural setting, and will contribute to greatly improved wildlife foraging opportunities. This zone is characterized by an open park area interspersed with trees such as the coast live oak (*Quercus agrifolia*), valley oak (*Quercus lobata*), and California buckeye (*Aesculus californica*), all trees with wide, open canopies. The oak mix will provide canopied shade in summer, and mixed shade and sun in the winter. This plant community is dominated by coast live and valley oak, with a diverse understory of low shrubs and herbaceous plants and a mid-story of larger shrubs and small trees. This area can border lawns, but should not have an irrigated lawn understory.



OPEN SPACE



Figure 6.8.5 Canyon mix

Canyon mix

Plantings in shady pedestrian paseos and building courtyards emulate the region’s stream sides and canyons. The deciduous airy canopies provide dappled shade in summer while allowing full sun in winter months. This mix is dominated by trees such as the big leaf maple (*Acer macrophyllum*) and California sycamore (*Platanus racemosa*). This mix can also include other trees such as Pacific dogwood (*Cornus nuttallii*) as a secondary species. This mix of fruiting and flowering plants creates human-scale environments full of texture and color, and is well suited for stormwater management.

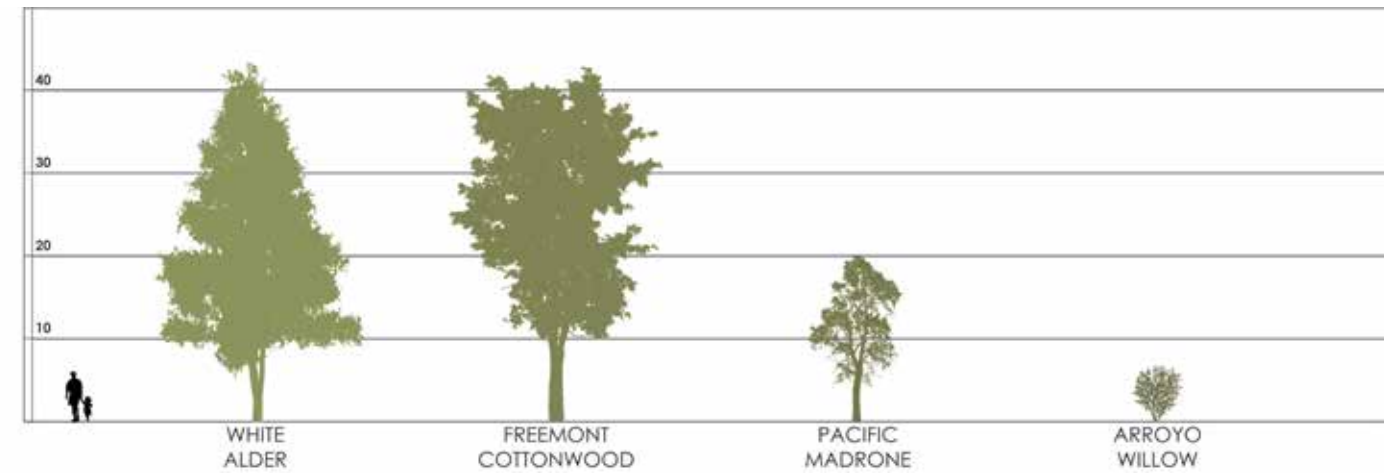

Figure 6.8.6 High canopy mix

High canopy mix

The master plan will seek to establish a tall, dense forest rich with high ecological value trees in locations where such impressive height is environmentally appropriate and attractive. This mix, characterized by larger trees, will provide shade for both people and building facades, and will be a significant part of both the connected canopy and the identity of the district.



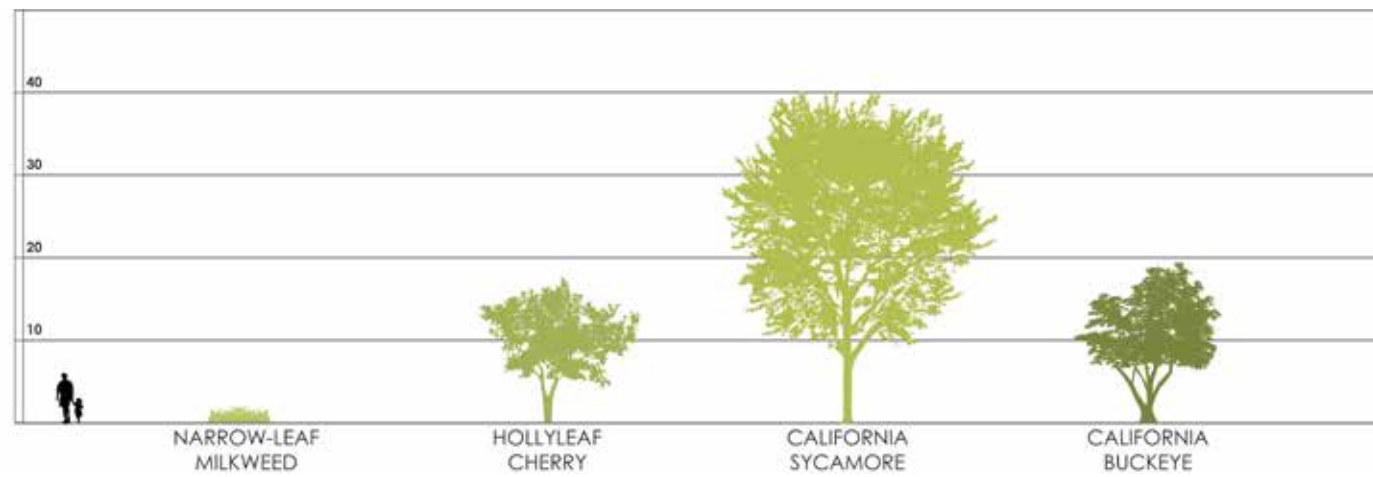

Figure 6.8.7 California sycamore mix

California sycamore mix

This mixture is dominated by trees such as the California sycamore (*Platanus racemosa*), California buckeye (*Aesculus californica*), and hollyleaf cherry (*Prunus ilicifolia*). It provides native trees in sunnier pedestrian paseos to create ecological links to the oak woodland mix found in Ellis Park. This assemblage of native trees supports a variety of birds, insects, and small mammals, creating opportunities for people to have contact with nature in their everyday lives. These species are also well adapted to stormwater management.

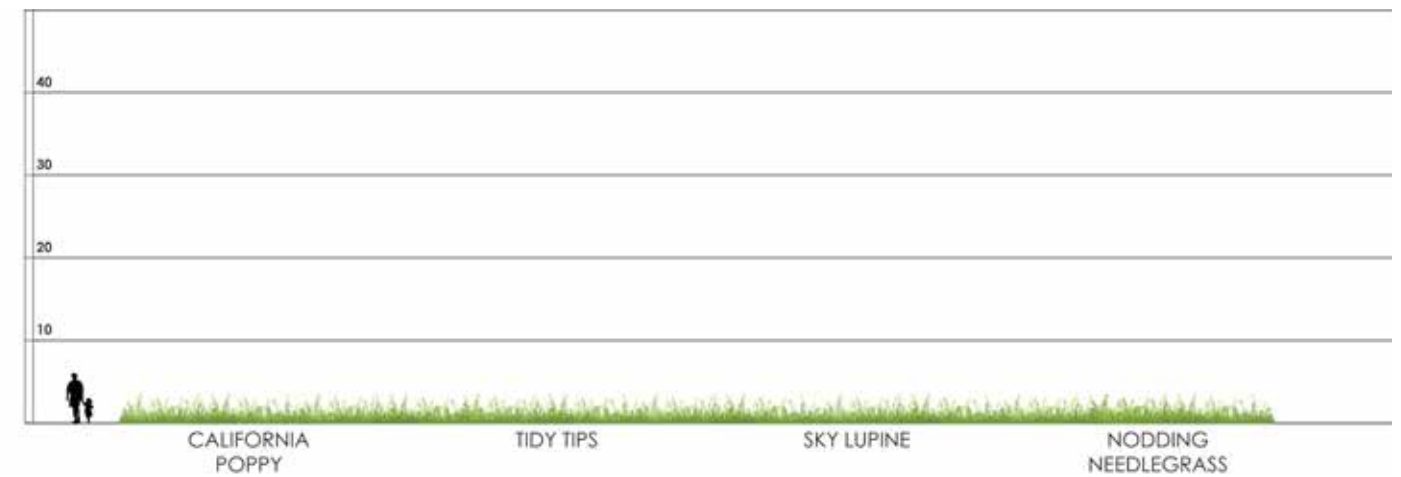

Figure 6.8.8 Pollinator meadow mix

Pollinator meadow mix

A carpet of flowering understory and ground-cover plants can color the northern plan area perimeter. This will expand the width of an existing wildlife corridor connecting the site's open space network to Stevens Creek and regional populations. This mix includes flowering understory plants, grasses, and groundcovers. An open meadow and diversity of plant species would attract and support a wide variety of pollinators in this zone.



6.9 Land and easement dedication

Land dedicated to the City

Approximately 6.97 acres of land will be dedicated to the City of Mountain View for Maude Park, Bridge Open Space, and Gateway Park, per City of Mountain View Ordinance No. 4.97, 3/25/97; Ord. No. 7.15, § 1, 10/13/15 and Ord. No. 3.21, § 1, 4/13/21. See Table 6.9.1 for more information.

Public Access dedicated to the City

Privately Owned Accessible Open Space: Approximately 5.79 acres of public access overlays, comprising 2.87 acres from Ellis Park and 2.92 acres from other open space will be provided. Ellis Park is a privately owned publicly accessible (POPA) open space per the Parkland Dedication Ordinance.

Other dedications: The Project will extend Logue Avenue north to the property of the City and County of San Francisco (also referred to as

SFPUC Hetch Hetchy) as a new street easement. Portions of the existing cul-de-sac will be vacated to provide a linear ROW. Refer to Section 7.7 for additional detail on this extension.

Easements will be required along ROW frontages to accommodate expanded sidewalks and landscaping adjacent to the travelway as described in the EWPP. As proposed in the EWPP, all curb-to-curb roadway widths will not change. Ellis Street will require 14 feet from the curb line for adequate planting and sidewalk widths. Because the property line along the east side of Ellis Street jogs by 5 feet, either a 4-foot or 9-foot street easement will be required along the development edge. A 4-foot street easement will be required along Middlefield Road and a 2-foot street easement will be required along Logue, Maude, and Clyde Avenues. Refer to Section 7.8 for additional detail on the proposed street designs.

Additional public utility easements may be required in order to maintain utility networks that connect through the proposed project site.

Table 6.9.1 Public access and dedication

Land dedication to City	+ 6.97 ac
Vacated ROW	- 0.08 ac
ROW dedication	+ 0.01 ac
New street easement (Logue Avenue)	+ 0.48 ac
New street easements	+ 0.40 ac
Privately owned publicly accessible	+ 2.87 ac
Public access areas	+ 2.92 ac
Total public access	+ 13.57 ac
Total site area	39.9 ac
Percent of total site	34%

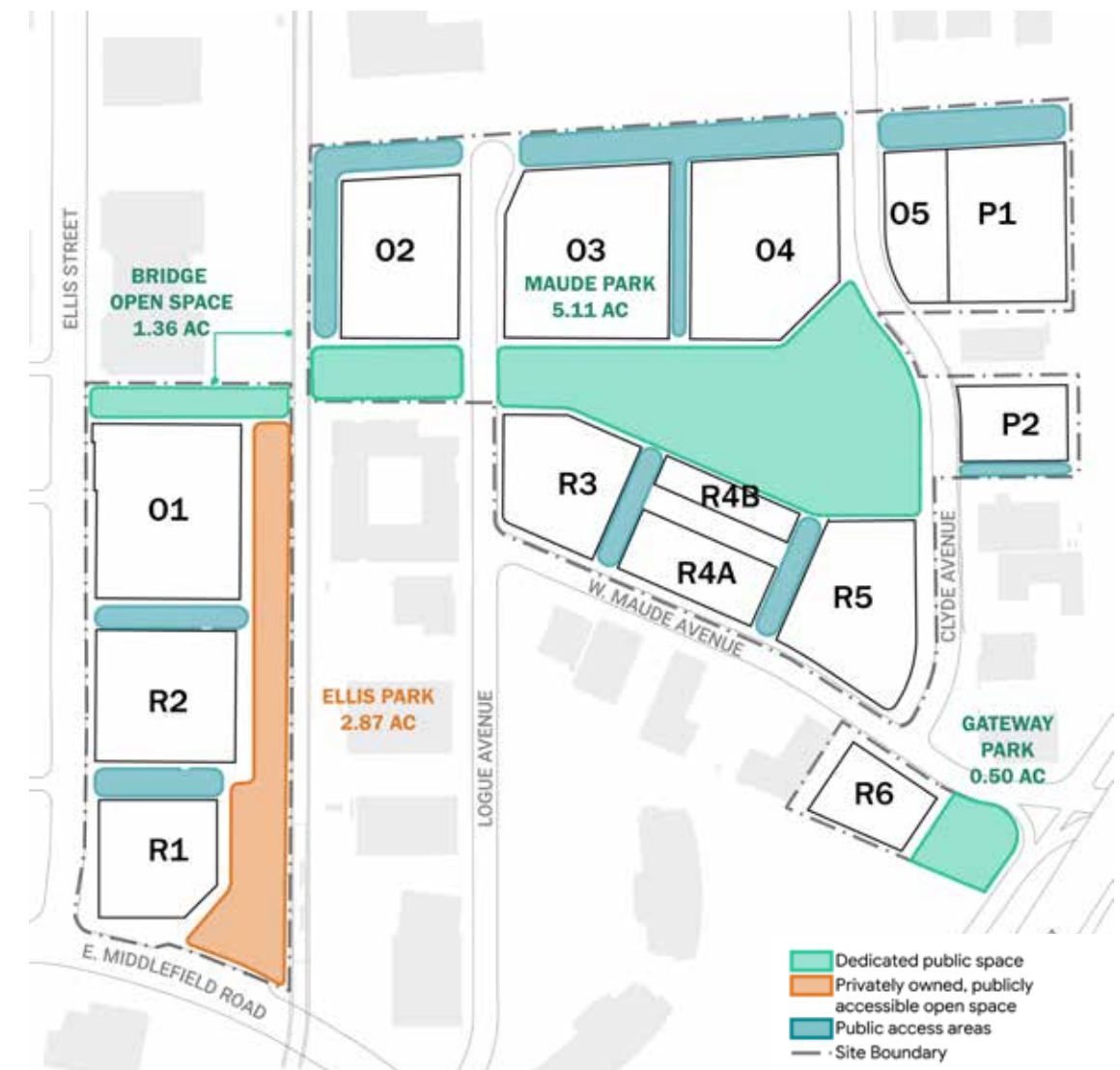
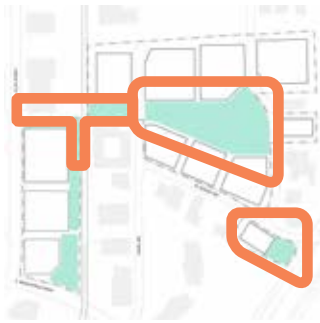

Figure 6.9.2 Public park dedication and easements



6.10 City parks

Bridge Open Space: connecting the district over the VTA

The ped-bike bridge connection over the VTA corridor that was analyzed and proposed in the EWPP is intended to support the EWPP’s goals and objectives of improving pedestrian and bicycle access across East Whisman; it could furthermore be a remarkable experience unique to Middlefield Park.

This dedicated park will be designed by the City. The MPMP is “bridge-ready”.

Maude Park: the heart of a new neighborhood

Maude Park (Precise Plan’s “Neighborhood Park”) will be a year-round amenity for East Whisman and the greater Mountain View community. This dedicated park will be designed by the City.

Maude Park and the community serving amenities will be directly across from a parking garage on Clyde to accommodate visitors to the park.

Its location in the heart of East Whisman can make it an environment where visitors engage with each other and the urban ecology of Maude Park.

Gateway Park: community and ecology

The mini-park at the corner of West Maude Avenue and SR 237 is intended to be a small-scale, neighborhood-oriented park. Existing heritage trees on the park’s perimeter provide a visual buffer between the highway and residential buildings as well as increased ecological value. Gateway Park provides direct access to open space from the residential parcel on the south side of Maude Avenue. This dedicated park will also be designed by the City.



Figure 6.10.1 Landscaped multi-use path vignette

OPEN SPACE

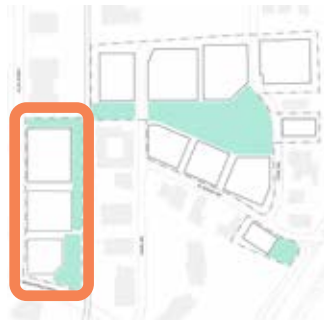

6.11 Introduction to Ellis Park

A new model of open space

Ellis Park runs along the existing VTA corridor to take advantage of light and views unobstructed by buildings. The open space will have an urban character with a high intensity of active uses at the neighborhood square – Ellis Plaza (Precise Plan’s “Central Park”) – as well as the extension of a variety of ground floor and open space activities and amenities along a promenade – Ellis Walk. The entirety of Ellis Park – Ellis Walk and Ellis Plaza together – will be designed, delivered and maintained as a privately owned, publicly accessible space (POPA).

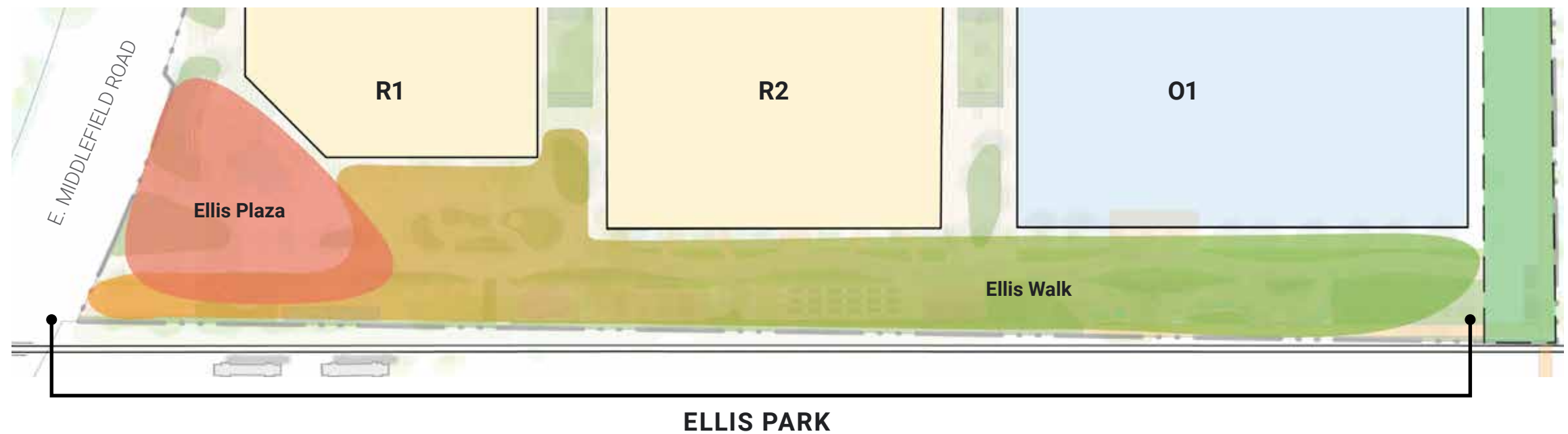

Figure 6.11.1 Ellis Plaza + Ellis Walk = Ellis Park



Figure 6.11.2 Character gradient from vivid arrival to immersive garden



Figure 6.11.3 Complementing nearby parks and park elements

OPEN SPACE

Ellis Park demographic context

While it is not possible to predict the exact residents of the East Whisman Master Plan area, the demographics, mirroring Mountain View as a whole, are expected to be quite diverse. The project is designed to welcome residents of all ages, from young families and working professionals to empty nesters and retirees and the project's open spaces will be designed to serve these diverse populations. A large portion of the population will likely be internationally born and will speak a diversity of languages.

The socio-economics will be similarly diverse with the project expected to provide housing for individuals and families earning anywhere from 30 percent to over 100 percent of the area median income. Household sizes may be slightly smaller than the Citywide averages due to the fact that









multifamily units tend to have fewer bedrooms on average than the single-family homes that currently make up a large portion of the City's housing units. Demographics may also vary over time as the project, City and surrounding areas continue to grow and change.

Ellis Park's programming is designed to serve employees, residents and visitors alike. While the East Whisman Precise Plan area includes no residents today, the Precise Plan EIR studied up to 10,570 new residents for the area in the future, accounting for approximately 12 percent of the City's future residential population.¹ Nearby residents in the South Whisman Precise Plan area, totaling approximately 1,200 residents, will also benefit from Ellis Park. As the East Whisman Precise Plan is realized, the area will grow in jobs, retail services, and homes, accounting for nearly 18 percent of Mountain View's service population.

The park's proposed programming ranges from tot lots to educational/demonstration gardens to picnic areas in an effort to meet the needs of families, residents, visitors, and workers. This range in programming – active and passive, for children and for adults, for commuters and residents – allows Ellis Park to serve both today's population as well as the area's increasingly diverse population in years to come. Adjacent to the VTA Middlefield Light Rail Station, Ellis Park is primed to serve a growing workforce, as well as an aging population that can benefit from walkable, car light lifestyles.

The design of Ellis Park considers the needs of today's nearby residents and adjacent employees, as well as the robust community of employee, residents, and visitors provisioned for in the East Whisman Precise Plan.

Table 6.11.4 City of Mountain View Demographics¹

 City Population	82,739
 Median Household Income	\$139,720
 Age Distribution	
0 - 5: 6%	45 - 54: 12%
5 - 17: 13%	55 - 59: 5%
18 - 24: 7%	60 - 64: 5%
25 - 34: 24%	65 - 74: 6%
35 - 44: 17%	75 + : 5%
	34.8 (median)
 Foreign Born	42.2%
 White alone, not Hispanic or Latino	43.9%
Asian alone	31.8%
Hispanic or Latino	18.3%
Two or more races	1.6%
Black alone	4.6%
American Indian/Alaskan Native alone	0.4%
Native Hawaiian/Pacific Islander alone	0.3%
 High School Degree	92.9%
Bachelor's Degree or Higher	69.5%
 Avg Commute Time	24 mins
69.1% drive alone	
 Poverty Rate	6.7%

¹ Sources: US Census Bureau QuickFacts (July 2019); 2019 American Community Survey 5-Year Estimates

¹ EWPP Integrated Final Environmental Impact Report, January 2020

Community outreach

Over 40 community meetings were conducted during the creation of the Middlefield Park Master Plan, with the involvement of numerous organizations (see Table 6.11.5 for a complete list of participating organizations). During this outreach process, the community was most focused on building community, expanding the ecology, providing recreation, and integrating amenities.

Ellis Park proposed program

Community can be fostered with spaces for gathering and sharing; built elements such as amphitheaters, communal dining areas and community gardens all bring people and cultures together of all ages.

Ecology can be expanded with focus on tree canopy, use of native plant species that are resilient to climate change, and support migration paths.

Recreation can be provided by playgrounds for varying physical abilities, spaces for pickleball, or other small court sports, skating, and exercise for pets at a dog park.

Amenities desired to be integrated ranged from drinking fountains and restrooms to public art and a plaza. Community feedback fell into six broad categories and is summarized here:

General feedback

- Retain flexibility in public space uses to allow for change over time;
- Pair commercial uses with park amenities;
- Fitness;
- Food uses.

Site amenities

- Outdoor seating (benches); outdoor dining (tables and chairs);

- Mix of shade and sun;
- Native ecology, tree canopy, pollinators;
- Bike and pedestrian connections;
- Drinking fountains;
- Public restrooms;
- Waste receptacles (discreet);
- Bike parking;
- Flex-use areas for community events (performances, farmers market);
- Space for food truck parking.

Community uses

- Small food and beverage kiosk (coffee, beer garden);
- Sport court(s) (pickleball);
- Community garden;
- Play area for younger kids (tot lot);
- Play area for older kids (adventure/nature play);
- Dog park;

- Barbecue and picnic area;
- Outdoor fitness area.

Public art

- Interactive art;
- Interesting for kids and adults alike;
- Doesn't have to be 'giant,' can be discoverable;
- Showcase tech, new media, global connectivity;
- Include a water element – stream, pond, bird bath;
- Possible rotating art to showcase local artists;
- Feature local student work.

Ecology and sustainability

- Native plants and pollinator species;
- Reduce hardscape and maximize shade;
- Trees and umbrellas;

- "Dark sky" lighting to minimize wildlife disturbance;
- Protect and enhance ecological corridors;
- Compost and recycling, water conservation.

Mobility and access

- Direct and easy walking and biking routes through and to/from district;
- Bike repair station;
- "Bike garden" to teach kids to ride;
- Desire to underground VTA tracks.

OPEN SPACE

Table 6.11.5 Outreach organizations	
Bay Area Council	Livable MV
Cafecito	MV Chamber of Commerce
California Native Plant Society	MV Coalition for Sustainable Planning
California Station Neighborhood Association	MV YIMBY
Canopy	North Whisman Neighborhood Association
Carbon Free MV	Santa Clara Valley Audubon Society
Community Services Agency	Santiago Villa Neighborhood Association
Costa Mesa Terrace HOA (Sunnyvale)	Sierra Club Loma Prieta Chapter
Day Worker Center of MV	Silicon Valley at Home
Friends of MV Parks	Silicon Valley Bicycle Coalition
Friends of Stevens Creek Trail	Silicon Valley Leadership Group
Graduates of Chinese Civic Leadership Academy	Slater Neighborhood Association
Great Streets MV	Spanish Civic Leadership Academy
Greenbelt Alliance	Wagon Wheel Neighborhood Association
GreenSpaces MV	Whisman Station Neighborhood resident
League of Women Voters	

Table 6.11.6 Proposed program areas*	
Bike parking	2,000 sf
Station garden	1,000 sf
Interactive public art	250-750 sf
Cafe terrace	Interior - 250 sf Exterior - 1,750 sf
Multi-purpose lawn or dog run	2,000 sf
Playground - youth	2,500 sf
Playground - tot	2,500 sf
Game courts**	2,500 sf
Picnic pavilion	750 sf
Community room and restrooms (In Ellis Park or R1/R2)	1,000 sf
Educational/demonstration garden	3,500 sf
Exercise area	1,000 sf

* Program elements and sizes may be adjusted through the permit entitlement process and will comply with the minimum requirements per City Code.

** Proposed game courts will align with the industry-standard size for the proposed sport.

OPEN SPACE

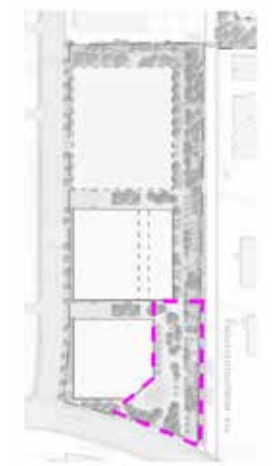

Key: Ellis Plaza

6.12 Ellis Park and Ellis Plaza scale comparisons

Ellis Park scale comparisons

The linear arrangement of Ellis Park is distinctive and has been proven successful in many other public open spaces. The following comparisons of the size and scale of a variety of linear parks provides both a frame of reference for the Ellis Park concept while also demonstrating effective open space design. First, scale comparisons are provided for Ellis Plaza a 1-acre area (shown in Figure 6.12.1 as a dashed line). This multi-use space is the point of arrival and social heart of the west side of the district.



South Park
~0.9 acres, San Francisco



Plaza de Cesar Chavez
~3.0 acres, San Jose



Santana Row
~0.6 acres, San Jose

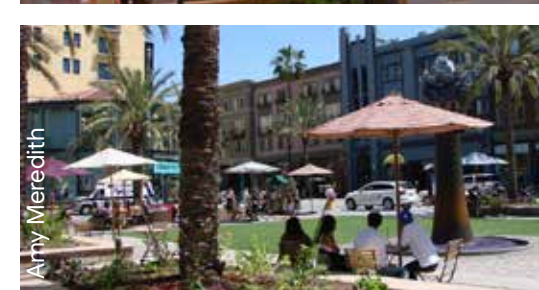

Plaza del Sol
~1.8 acres, Sunnyvale



Figure 6.12.1 1-acre Ellis Plaza scale comparisons

OPEN SPACE

Ellis Park scale comparisons: Bay Meadows - San Mateo, California

The linear arrangement of Bay Meadows in San Mateo offers an example of a successful linear arrangement of open space. The public park (approximately 2.3 acres in area) offers a variety of amenities to support a diverse community and encourage social interaction. The open space is anchored on the main street with a multi-use plaza that host events, including a farmer's market. The plaza is characterized by an interactive art installation. The opposite end of the park is anchored by a nature play area, a picnic pavilion, and a community garden. These very specific, diverse uses ensure that visitors are drawn along the entire length of the park.

Figure 6.12.3 provides a scale comparison between Ellis Park (an area of 2.87 acres, shown in a dashed line) and the 2.3 acres of Bay Meadows' linear public space.



Figure 6.12.2 Design precedent photos of Bay Meadows



Figure 6.12.3 Ellis Park scale comparison of Bay Meadows

**Ellis Park scale comparisons:
Klyde Warren Park -
Houston, Texas**

The linear arrangement of specific programming along one side of this open space illustrates a successful implementation of different programming elements immediately adjacent to one another. The lawn and seating areas anchor one end of the park with multi-purpose social space. The remainder of the park is activated by a series of program pieces which creates a place for a diverse range of visitors and a destination open space. The total area of the park is approximately 5.6 acres.

Figure 6.12.5 provides a scale comparison between Ellis Park (an area of 2.87 acres, shown in a dashed line) and the 5.6 acre Klyde Warren Park.

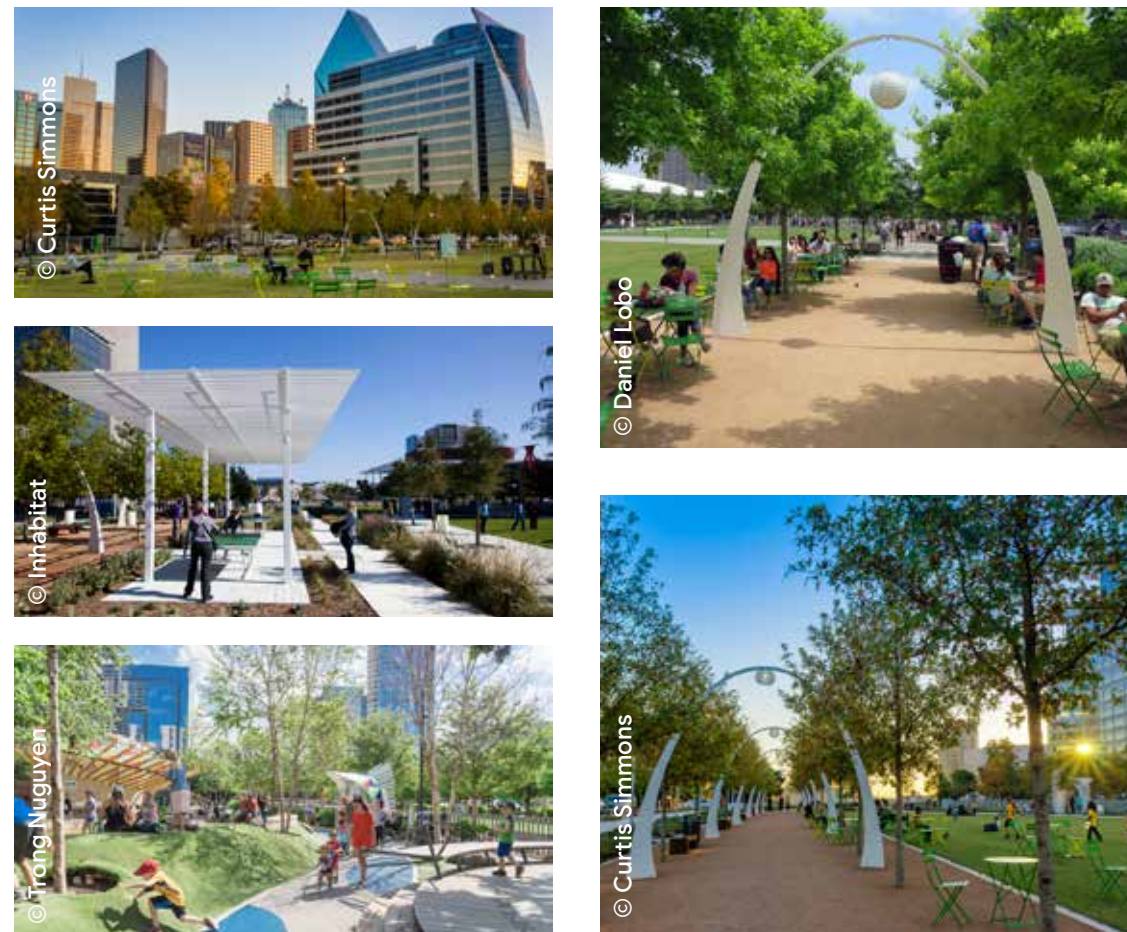

Figure 6.12.4 Design precedent photos of Klyde Warren Park

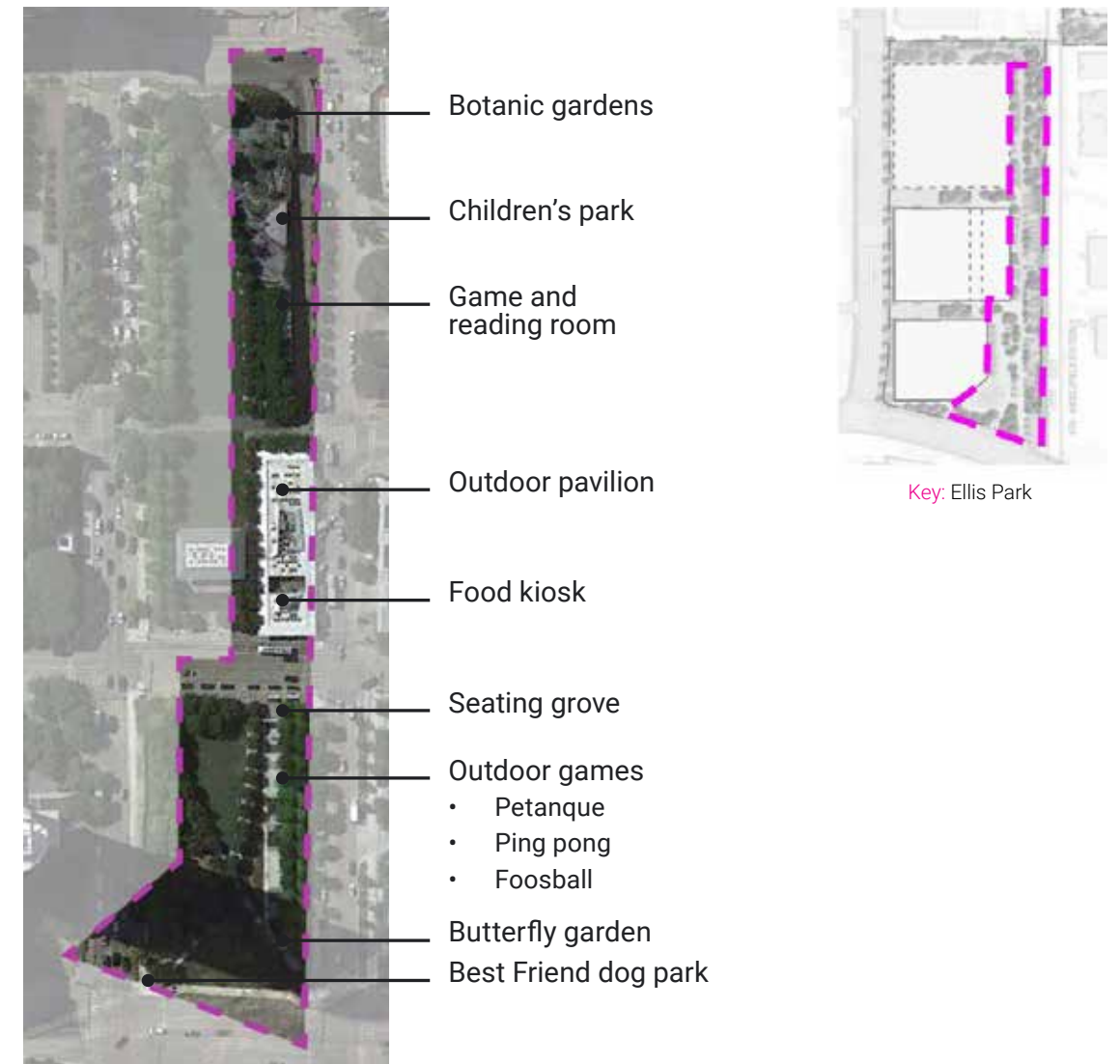

Figure 6.12.5 Scale comparison of Klyde Warren Park

OPEN SPACE



6.13 Ellis Park design

Ellis Park Design Principles

The Design Principles for Ellis Park build upon the Open Space Planning Principles that focus on social life, and ecology with a commitment to:

- A lively park that invites and builds communities;
- A park that utilizes native plants to create a resilient open space;
- A park that is whimsical and promotes play;
- A park that is well-organized, safe, and inviting for all.



Inclusive, accessible, active during the day and in the evening, builds community, fosters ecosystem of care



Native ecology, carbon sequestration, re-oaking, stormwater treatment, pollinators, reduced heat island effect

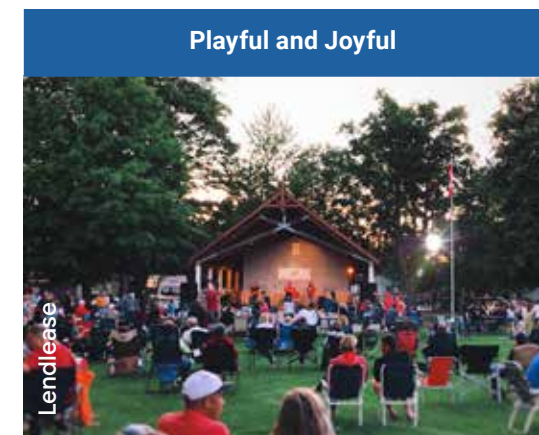

Celebrates play, whimsy, laughter, and joy

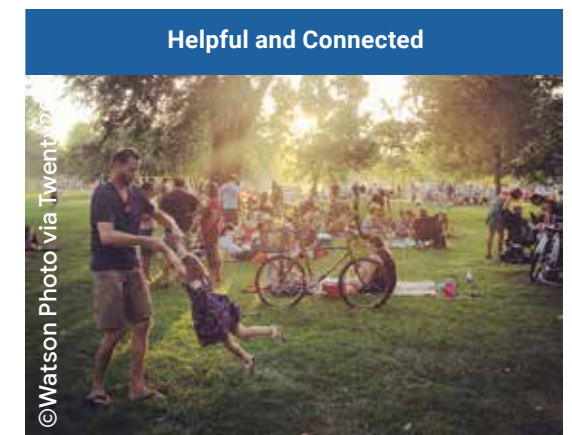

Bike-ped and transit connections, new parks, interpretive signage and wayfinding, events and spaces that bring the community together

Figure 6.13.1 Open space design character images

Ellis Park functions as an enhanced segment of the existing north-south greenway, with connection to a future new bridge over the VTA corridor – Bridge Open Space – connecting east-west across East Whisman.

The character and identity for the Ellis parcels, defined by the open space, will be established from day one:

- Delivers a sense of place with urban identity;
- Well-defined district open space that is fine-grained and walkable;
- Attractive urban complexity and variety of experience unique to the district;
- Multiple uses and amenities are connected to the convenience of the light rail, anchored by Ellis Plaza;
- Efficient open space corridor of flexible zones for various programs, which can relate to adjacent ground floor uses.

Incorporating City and VTA's design feedback

- Ellis Park will incorporate materiality and wayfinding tools to delineate bicyclist routes from pedestrian spaces;
- Ellis Park will incorporate policies and signage in the plaza to avoid potential collisions in this busy space;
- On-street bike lanes will also be provided as alternative travel lanes for fast cyclists;
- Food and beverage kiosk programming will vary over time and is intended to offer refreshments appropriate for all ages and surrounding seating will be family and pet friendly; will not be a 21+ only amenity at all times;
- Explore community food hub, educational/demonstration garden plots, and no or low fencing;

- Explore visual access and low fencing options around sports courts to increase public accessibility and permeability while maintaining safety.

Preliminary VTA feedback included:

- Broad support of a park adjacent to the transit stop;
- Entrance to station to remain clear and highly visible;
- Fencing of the sport courts may need to be taller along the tracks for rail safety;
- No established building setback from rail beyond those required by fire and building codes.

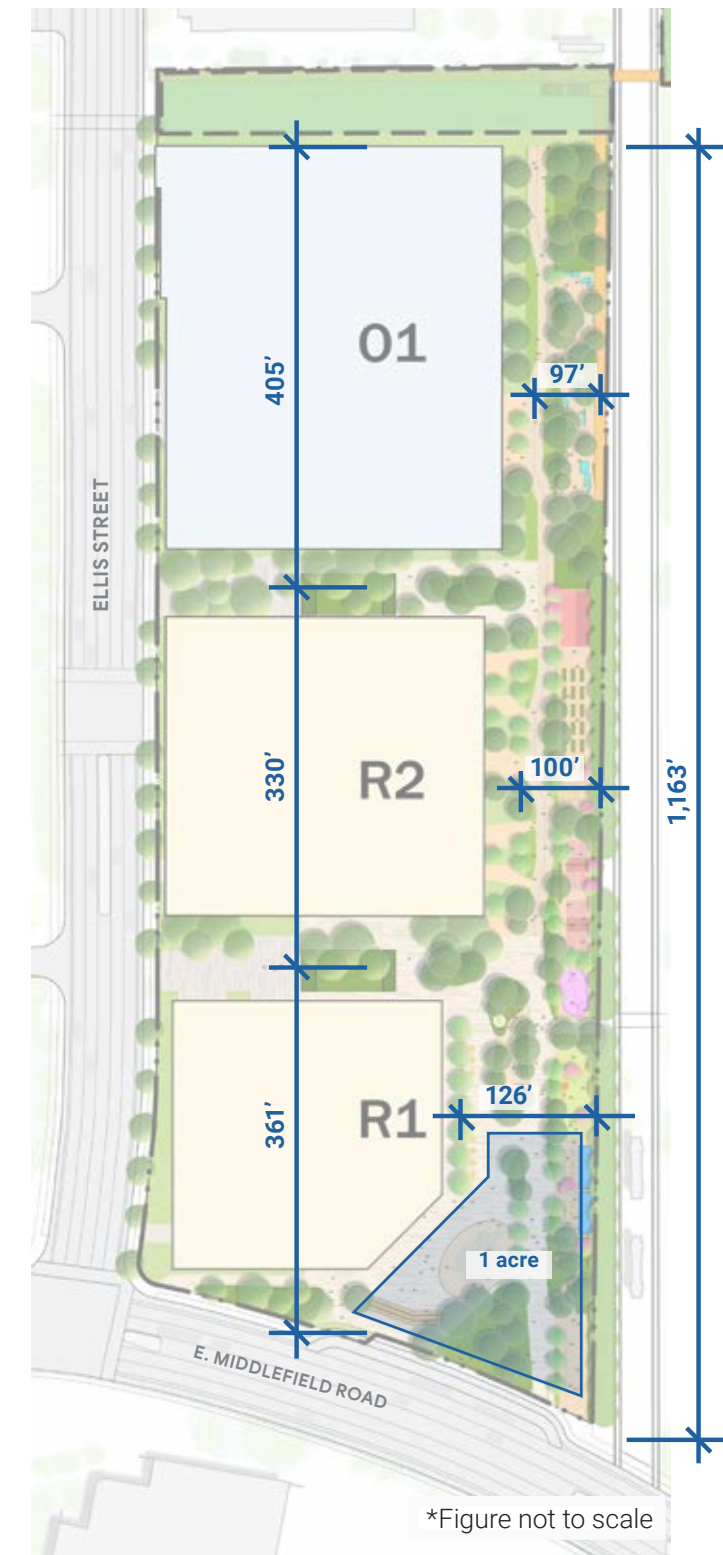

*Figure not to scale

Figure 6.13.2 Ellis Park plan

OPEN SPACE

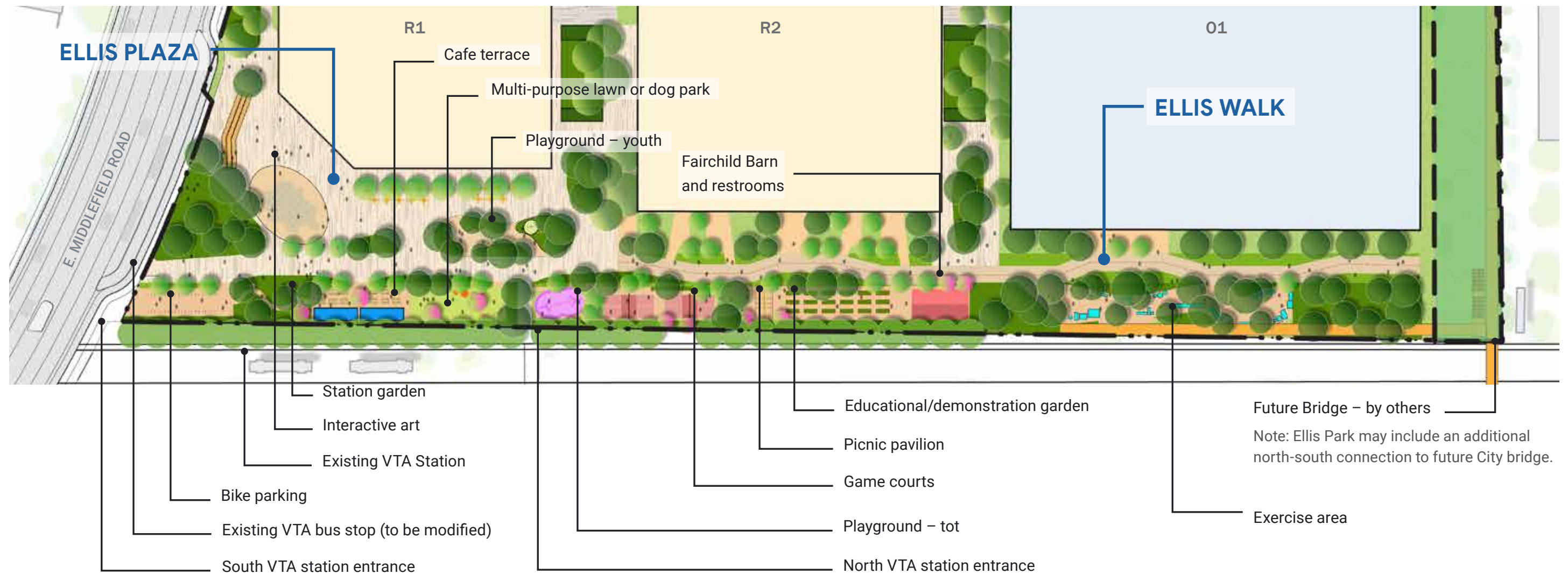

Figure 6.13.3 Ellis Park programming plan



Ellis Plaza: a town square for East Whisman

The centrally located Ellis Plaza will be the urban heart of Middlefield Park and anchors the district's open space network – a destination as well as a beginning and end to visitors' journeys. The civic character of this sunny square, wind-protected and surrounded on all sides by activity, will provide an intimate, welcoming urban moment within the fabric of the developing East Whisman district.

This neighborhood square will balance spatial enclosure with connections to Ellis Walk and the adjacent VTA Middlefield Station. Ellis Plaza will be a public "living room" where cafés and outdoor seating frames an open area large and flexible enough to accommodate temporary uses and events. Public art installations and special events could further create identity and attract people and activity at this destination.



Figure 6.13.4 Ellis Plaza vignette

OPEN SPACE

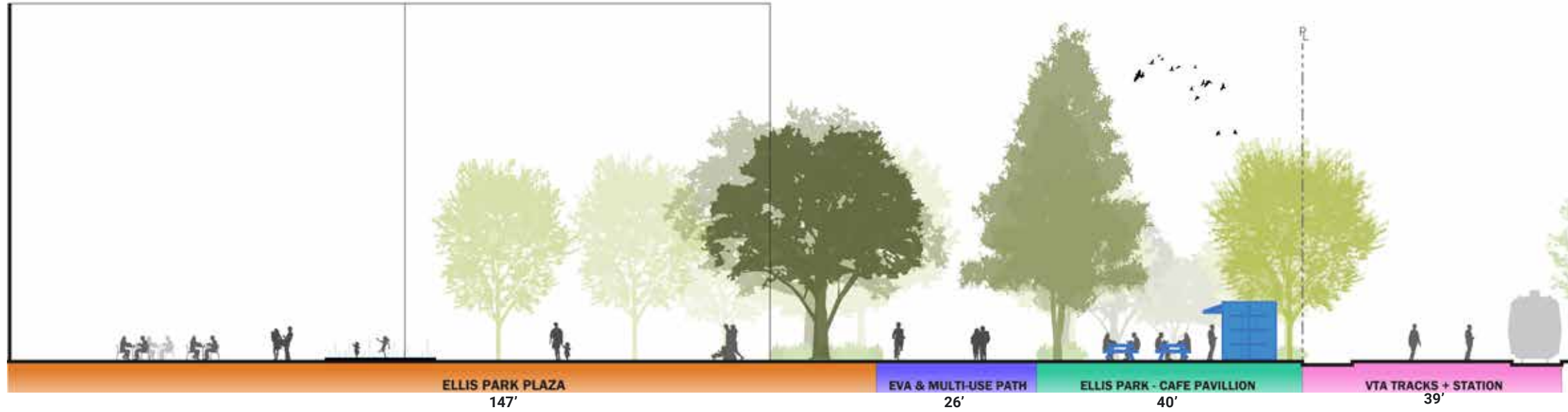

Figure 6.13.5 Ellis Plaza section, view looking north

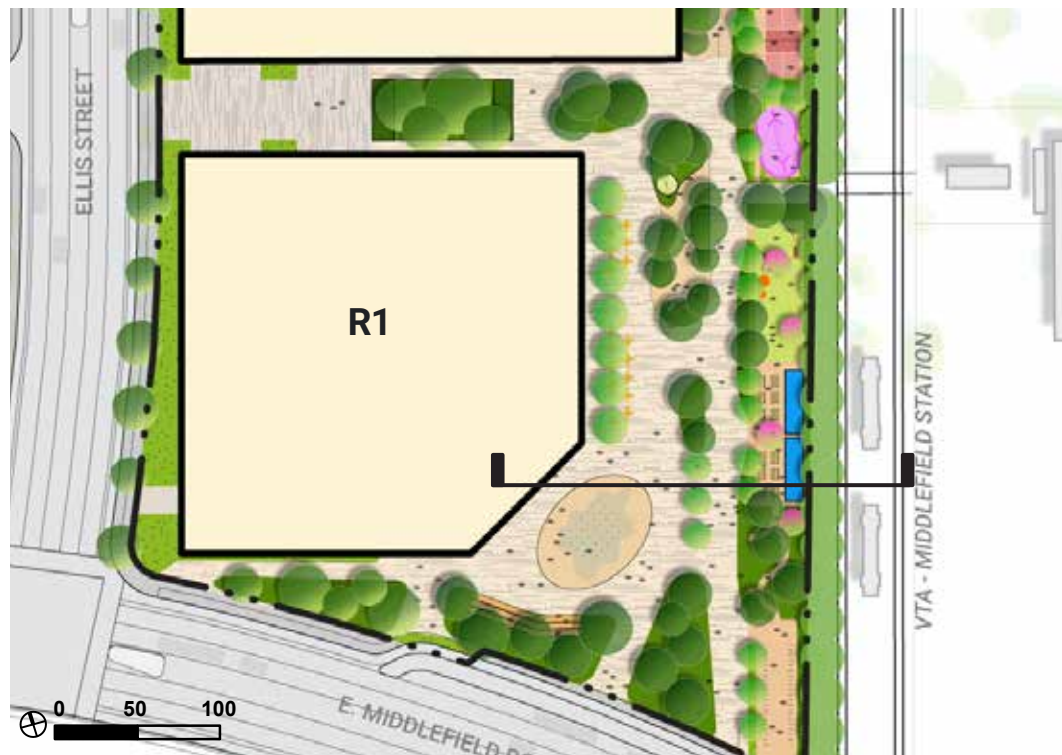

Figure 6.13.6 Ellis Plaza plan enlargement



Figure 6.13.7 Precedent images



Ellis Walk: something for everyone

Ellis Walk will be a lush, programmed promenade linking important site anchors such as Ellis Plaza and Maude Park to site arrival points for light rail, buses, and bicycles. It will be a new model of innovative open space for a pedestrian-friendly urban center, accommodating over time a variety of outdoor uses, at once specific and semi-permanent as well as flexible, to reflect a growing and diverse community. Ellis Walk is a multi-use path fulfilling a section of the greenway in EWPP; it also serves as Emergency Vehicle access (EVA).

Ellis Walk also includes active ground-floor spaces, street rooms for large and small gatherings, stormwater gardens, and various amenities that will create a lively and unique environment under the connected canopy and within extensive planting. Ground floor uses along Ellis Walk will be diverse in design

and program, enlivening the street with storefronts, cafés, and community-serving spaces that will spill out onto the promenade and complementing adjacent open space uses.

A multi-use lawn and station garden offer public areas of respite for visitors and people waiting for the train, as well as spill-out space during events in the plaza. Between the lawn and garden is a café pavilion with outdoor seating, creating both a destination for visitors and a place for commuters to wait and rendezvous. Bike facilities in Ellis Plaza include a fix-it station, bike parking, and a bike share station.

Ellis Walk — Residential Block 2

Community facilities that serve groups as well as individuals may be located in this segment of Ellis Walk. Ideally, the uses in the ground floor of the adjacent residential building support these outdoor uses and are integrated into



Figure 6.13.8 Ellis Walk at Residential 2 vignette

OPEN SPACE

the open space by stoops, patios, and terraces extending from the building.

The Fairchild Barn will provide multi-use space available to the entire community, as well as storage for the adjacent educational/demonstration garden. A picnic pavilion provides a shared area for those working in the garden to rest and gather, and for people to eat together outdoors. Next to the open structure of the picnic pavilion is a tot-lot and a pollinator garden — a place for small children to play with caregivers looking on. Complementing the tot-lot is a youth nature-play area directly across the promenade. Sport-courts complete the social and active use amenities in this segment of Ellis Walk.

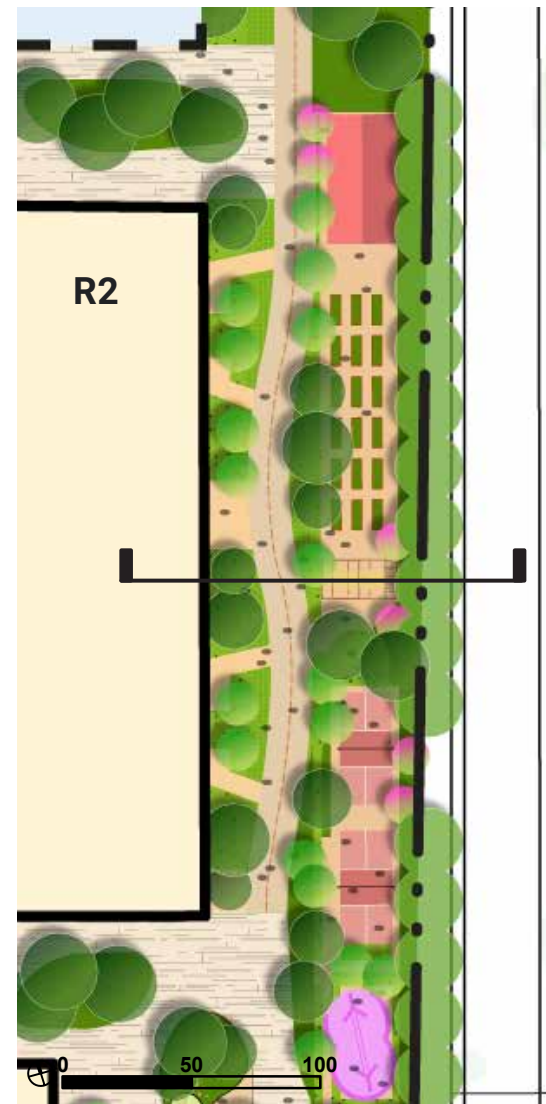

Figure 6.13.9 Ellis Walk at Residential 2



Figure 6.13.10 Ellis Walk at Residential 2 section, view looking north



Figure 6.13.11 Precedent images





Ellis Walk — Office Block 1

A potential ramp to the future pedestrian bridge and abundant trees define this segment of Ellis Walk. The adjacent ground floor of the office building will be visibly accessible and dynamic, to contribute to the vibrant sense of place and the integration of the office with the broader community. Open space under the trees and bounded by the promenade can be activated with publicly accessible fitness equipment, creating an environment conducive to individual and group exercise.



Figure 6.13.12 Ellis Walk at Office 1 vignette

OPEN SPACE

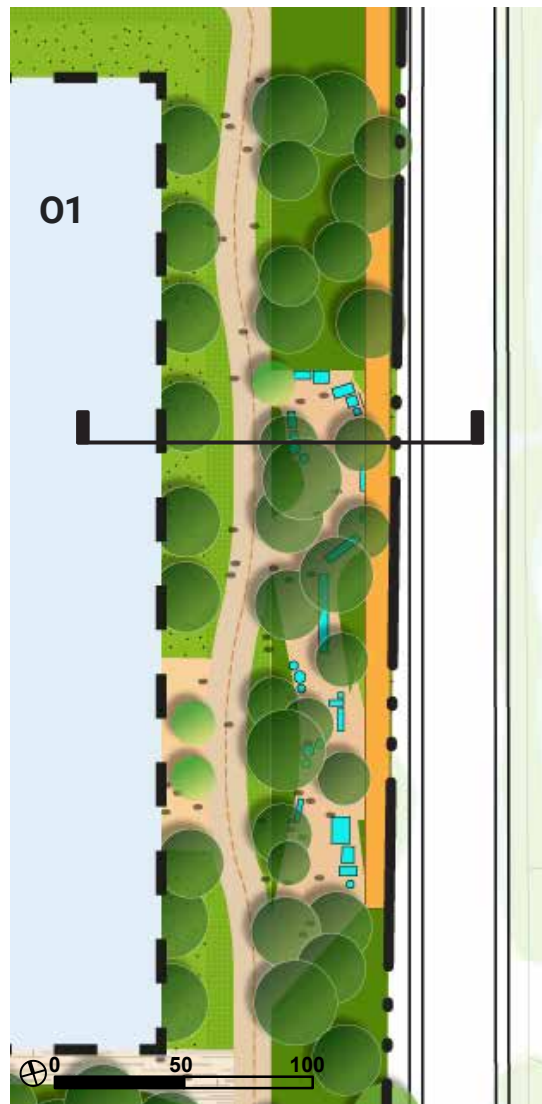

Figure 6.13.13 Ellis Walk at Office 1 plan



Figure 6.13.14 Ellis Walk section at Office 1 fit lot and bridge, view looking north



Figure 6.13.15 Precedent images



Ellis Park maintenance and programming

The Master Plan concept for Ellis Park establishes a framework for open space organization and strategy for locating specific types of uses, with attention to the adjacencies of uses to support social life and interaction, and make a place that invites everyone. This framework is inherently flexible and allows for change of program elements in the future as necessary to accommodate a variety of social uses. Programming of the park is essential to its success: this includes the deployment of movable of site furnishings. To ensure a welcoming open space, attention to regular maintenance is essential for the park to remain inviting and valued.

- Plaza programming and maintenance will be the responsibility of the landowner (or Park Operator designee) in perpetuity;
- As design develops, program elements and their operations will be described in more detail;
- The Park Operator will also own and maintain the spill out spaces associated with the ground floor retail lining the plaza;
- The Park Operator will be highly incentivized to carefully maintain and thoughtfully program these public spaces in order to attract and retain retail and residential tenants in R1 and R2, and for office operations of O1;
- The Project will make best efforts to collaborate with local community groups to tailor programming to local community needs and to support the meaningful work of local nonprofits;
- The Park Operator may also create a security plan to ensure the plaza and park remain safe for all to enjoy.

This page intentionally left blank.

7. CIRCULATION AND MOBILITY

A successful future in Middlefield Park depends on redesigning the district's transportation system to prioritize the efficient movement of people over fewer vehicle trips. Implementing a complete street system that prioritizes access and safety for all users, while integrating the local land use context and supporting flexibility for future technology and innovation will create reliable, healthier, and more sustainable transportation options.

7.1 District approach

Complete Streets approach

The redesigned street network will expand multimodal transportation infrastructure to accommodate all travel modes, with an emphasis on bicyclists and pedestrians. In accordance with design best practices for active mobility and the EWPP, all streets in Middlefield Park – including biking and walking facilities – are designed for all ages and abilities. For bikes, this means wide, physically protected bike lanes (where feasible) that increase overall connectivity and link up with key regional routes. Sidewalks are wide, tree-lined, and include many new routes between residences and offices, creating a dense and flexible network of options for pedestrians. The addition of new crossing improvements will also provide more flexibility for pedestrians and will also have a traffic calming effect on vehicles. Extensive trees and native plantings

along streets will create a pleasant, shaded experience that encourages a broader range of active users.

Great place fosters great mobility

One of the EWPP guiding principles is to prioritize transit, biking and walking to create a district that is connected, accessible, safe and enjoyable. Concentrating a denser mix of land uses and public open spaces around VTA Middlefield Station will establish neighborhood-serving destinations within a 10-minute bicycle-ride and 20-minute walk anywhere within East Whisman. Creating quality places through strategic integration of land use and transportation serves the sustainability of the district and fosters a sense of community.

A coordinated effort

The transportation improvements shown in this document build off of the priority transportation improvements envisioned in the EWPP. The Project promotes a combination of traditional infrastructure solutions and creative transportation demand management (TDM)/parking management solutions to improve mobility in Middlefield Park. The connectivity of open spaces outlined in Chapter 6 also directly supports this plan's vision of a safe, healthy, convenient, and multimodal circulation strategy in Middlefield Park.

Future-ready

The transportation network improvements proposed by this Project embrace the dynamic potential of innovation in transportation systems, as anticipated by the EWPP. The Project focuses on building a complete street system that can be adaptable

to an autonomous future via the provision of on-street flex zones and limited supply of off-street parking.

Providing better choices

A successful transportation system provides convenient and affordable options that are reliable, flexible, and user-focused. The Project fosters the EWPP's vision to increase transit use, walking, and biking within the district by concentrating higher density residential, retail, and office within a 10-minute walk of the VTA Middlefield Station, and committing to expanding the active transportation network by enhancing on-street bike facilities and implementing new off-street shared-use paths. Middlefield Park is also committed to reducing overall gateway automobile demand via projects and programs that support the increased use of transit, cycling and walking with improvements consistent with the

priority transportation projects outlined in the EWPP. The following are key strategies to actively increase transit use, walking, and biking within the district:

- **Active transportation network:** The Project includes components that improve existing facilities and create a more accessible neighborhood, including upgrading bicycle facilities, sidewalks, and pedestrian crossings on Ellis Street, Middlefield Road, and on Logue, Maude, and Clyde Avenues.
- **Additional connectivity:** An element of the EWPP is a new grade-separated crossing over the light rail line north of VTA Middlefield Station, connecting east-west across East Whisman. Such a connection is incorporated into the planning framework of Middlefield Park. The Project also proposes implementing new off-street, multi-use paths through Ellis Park that provide seamless connections to surrounding sidewalks and on-street bicycle lanes.

Transportation Demand Management

(TDM) Plan: Google began operating its first employee shuttle in 2004. Today, Google’s transportation team is recognized as a leader in reducing commuter dependence on the car, with a drive-alone commute mode share of about 42 percent in Mountain View. Google’s shuttle system and significant share of employees that commute via biking are two of its most successful TDM program elements. The Project is committed to multimodal mobility initiatives that support sustainable growth and enhance the surrounding district. Refer to the Middlefield Park TDM Plan, included in the Implementation Plan, for further information.

- **Support the Transportation Management Association:** The Project will join and coordinate with the Mountain View Transportation Management Association (MTMA).

Minimizing parking

It is important to recognize the role parking plays in reducing single-occupancy vehicle (SOV) use. To prioritize non-car trips, Middlefield Park will make parking part of the solution, for which thoughtful parking policy, placement, design and management will be key elements. The Project will reduce residential and office parking below the EWPP maximums. Furthermore, the Master Plan considers potential shared parking configurations for the mixed-use residential and active use buildings, and the office and park users in the district parking structures. The amount of parking spaces that can be shared will be determined by a parking demand study and corresponding demand management plan.

Table 7.1.1 Citywide mode share in Mountain View

Mode	Share
Drive alone	70.5%
Carpool	6.7%
Transit	7.5%
Walk	2.7%
Other (bike, drop-off, etc)	7.7%
Do not commute	4.9%

Source: 2018 American Community Survey Estimates

Table 7.1.2 Googlers in Mountain View today

Sub-Mode	Share
Drive alone	42.2%
Carpool	3.9%
TNC/Drop-off	2.4%
GBus	31.3%
Transit	2.0%
Bike	6.1%
Walk	0.6%
Do not commute	11.5%

Source: Google in Motion Survey 2019

7.2 Mobility futures

The Middlefield Park Master Plan accommodates future modes of transport including both new technologies and operating models and services. Over the coming years, autonomous vehicles and new innovative transport systems have the potential to introduce transformative changes to mobility norms.

Mobility as a Service (MaaS)

The multimodal integration of different services offered by MaaS providers and operators will result in a shift away from car ownership. MaaS will enable users to access transport without the cost of owning and maintaining a vehicle, and transport services will increasingly be shared across the community. The Project will accommodate the expected increase in shared services by strategically designing passenger loading areas for office, residential, and active uses.

Demand-responsive transport

Demand-responsive bus and shuttle services are expected to be rolled out more widely in line with the adoption of MaaS and shared services. These

services will support the use of transit and a reduction in private car use by offering a level of service comparable in availability and routing flexibility to operating a private vehicle. The project design will include passenger loading areas that are conveniently located within walking distance of homes and offices.

Autonomous vehicles

Fully autonomous vehicles (AVs) will be capable of completing journeys safely and efficiently, without a driver, in a range of road and weather conditions. Future shared autonomous vehicles are expected to be hailed on demand, 24 hours per day and may not require parking at travel destinations. The Project includes a curbside management plan to guide

the strategic location and management of loading areas for passengers and goods deliveries (see Section 7.10).

Parking demand

The expected decrease in single-occupancy vehicle (SOV) use and increase in ride hailing services combined with a reduction in car ownership and expected adoption of AVs will significantly affect parking demand on-site. The demand for short-term parking is expected to increase for passenger loading activities and the delivery of goods, while long-term parking demand is expected to decrease. The Project's curbside management plan and overall parking strategy account for these anticipated changes in parking demand.

Micromobility

The continued availability of bike and scooter share systems in urban areas provides additional travel options and first-mile/last-mile connections. This distributes travelers across more modes, reducing excessive demand on any one of them. The Middlefield Park Project design will accommodate and encourage use of micromobility services by providing dedicated on-site spaces for storage and implementing micromobility programs via the TDM Plan.

7.3 A multimodal network

Middlefield Park offers a dense, interconnected, multimodal network that prioritizes the health of residents, employees, visitors, and the environment. By making the healthiest choice for travel the easiest choice for people of all ages, abilities, and incomes, Middlefield Park can be a model for 21st-century mobility in Mountain View.

The EWPP calls for new parks, new streets, and new pedestrian crossings. Prioritizing safe, convenient routes for pedestrians, bicyclists, and transit users will support more sustainable, environmentally responsible modes of travel. Figure 7.3.1 outlines the multimodal network.

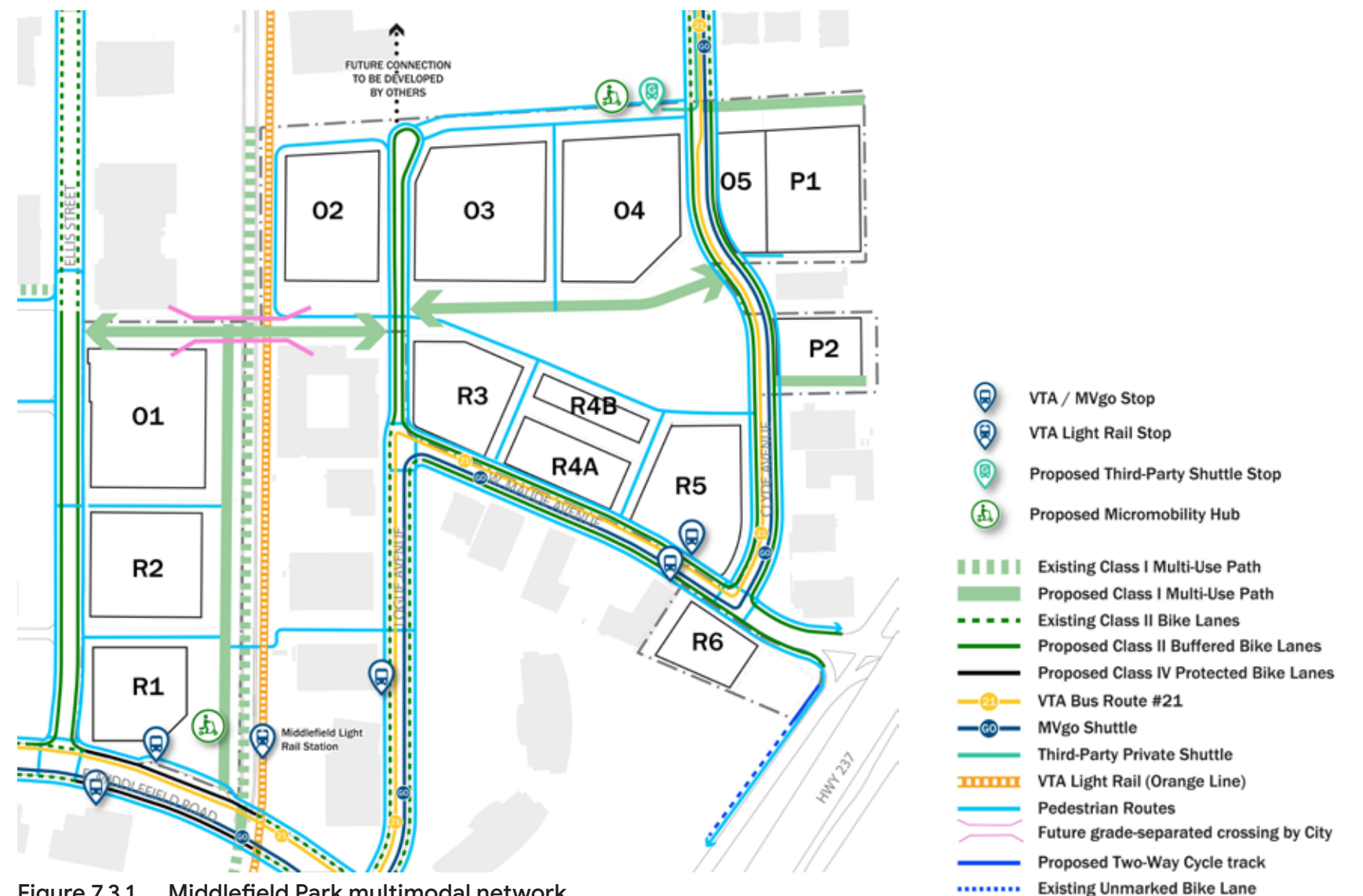

Figure 7.3.1 Middlefield Park multimodal network

7.4 Pedestrian network

New streets, car-free paths, and a potential new pedestrian and bike crossing traversing the VTA corridor will combine to increase the porosity of Middlefield Park and make walking an attractive and convenient way to get around. Internal paths, including new pathways between buildings, provide access to offices, active uses, residences, and through Ellis and Maude Parks. New pedestrian crossings along Middlefield Road, Ellis Street, Logue Avenue, and Clyde Avenue will improve the pedestrian experience and offer varied choices for pedestrians to move from origin to destination. Multi-use paths and paseos wind through the Project, providing safe, social connections between buildings on the site and for people moving from East Mountain View into Sunnyvale.

A pedestrian flow model was developed to assess envisaged future pedestrian flows based on volumes and routing as

shown on Figure 7.4.1, which is based on forecasted pedestrian trip generation, distribution and assignment anticipated for an office campus in a mixed-use environment. The model focuses on the morning peak period and includes the main commuter routes from transit, GBus stops and residential buildings to offices. The prediction of pedestrian flows helped to refine proposed pedestrian infrastructure enhancements such as signalized pedestrian crossings, and path alignment. New pedestrian links have the highest pedestrian volumes, especially those associated with new dedicated off-street pathways and traversing the VTA corridor.

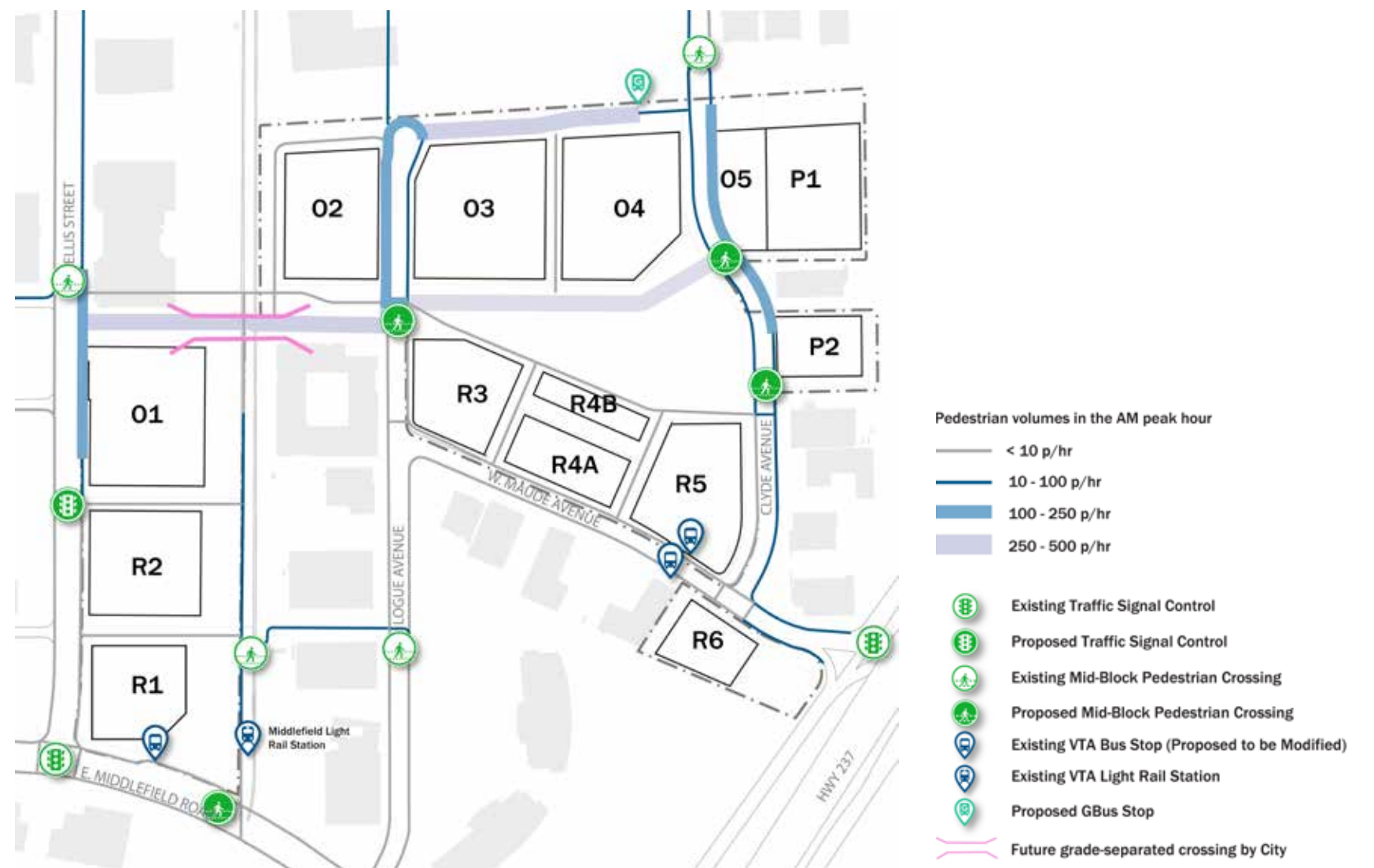

Figure 7.4.1 Middlefield Park AM peak hour pedestrian flow

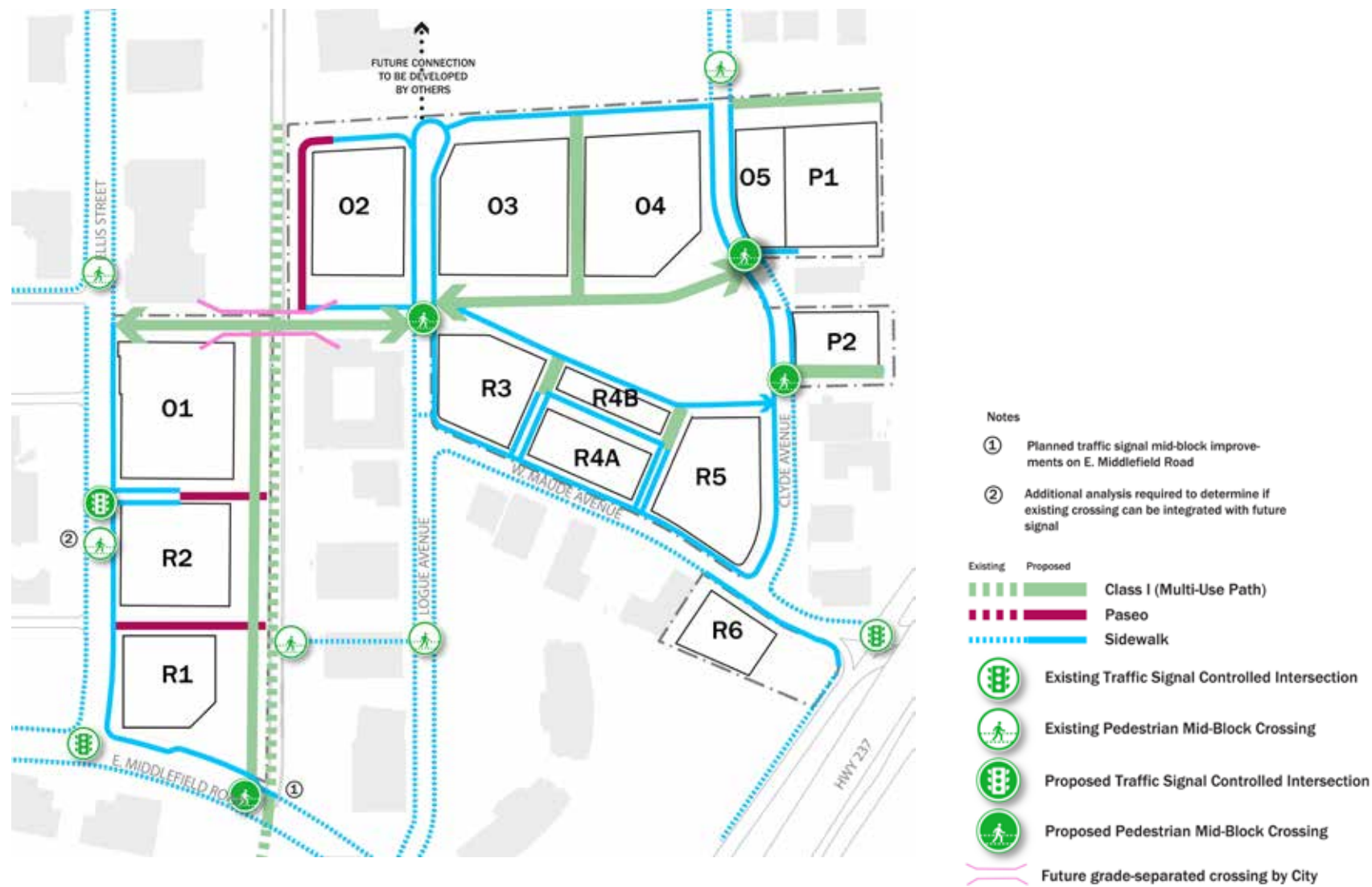

Figure 7.4.2 Proposed pedestrian network improvements

Pedestrian crossings

The Middlefield Park Master Plan incorporates a variety of recommended pedestrian crossing improvements based on a preliminary evaluation and current best practices. The preliminary pedestrian crossing improvements are listed below.

Logue Avenue mid-block crossing:

Installation of a new rectangular rapid flashing beacon (RRFB) controlling the mid-block crossing on Logue Avenue north of Maude Avenue. This improvement is not identified in the EWPP but is recommended to accommodate anticipated pedestrian and bicycle demand across Logue Avenue at the bridge path.

Logue Avenue/Maude Avenue intersection:

Add crosswalks to create a high-visibility pedestrian crossing.

Ellis Street/O1/R2 driveway intersection:

Installation of a new traffic signal controlled intersection.

This improvement is not identified in the EWPP but is recommended to safely manage vehicle and pedestrian demand to and from the O1/R2 building driveway at Ellis Street. The traffic signal controlled intersection will replace the existing pedestrian mid-block crossing just south of the future driveway.

Clyde Avenue mid-block crossings:

Installation of traffic controlled mid-block crossings on Clyde Avenue, one just south of the O5 building and the second just south of the P2 parking structure. These controls may include traffic signals, active controls (e.g. RRFB) or enhanced, highly-visible crosswalks, depending on pedestrian volume. These improvements are not identified in the EWPP but are recommended to provide safe crossing treatments for pedestrians who park in either parking structure on the east side of Clyde Avenue and are required to cross Clyde Avenue.

Bridge across VTA corridor: A grade-separated crossing of the VTA corridor is recommended in the EWPP and is incorporated into the planning framework of Middlefield Park. Although the City of Mountain View has not yet identified a preferred crossing design, the Middlefield Park Master Plan is “bridge-ready”. A new bridge would support the goals and objectives of the EWPP to improve pedestrian and bicycle access across East Whisman.

Pedestrian paseos

Making active mobility the first choice for Middlefield Park residents and visitors is a goal of this plan.

Publicly accessible residential paseos are proposed between a portion of O1/R2. A publicly accessible non-residential paseo is also proposed west of O2.

To provide bike and pedestrian north-south access through the project, in lieu of providing Street C, multi-use pathways are proposed between O3/O4 and portions of R3/R4(a+b)/R5.

See the Urban Design Objectives section in the Implementation document for design intent for transitioning between service streets and paseos or multi-use paths.

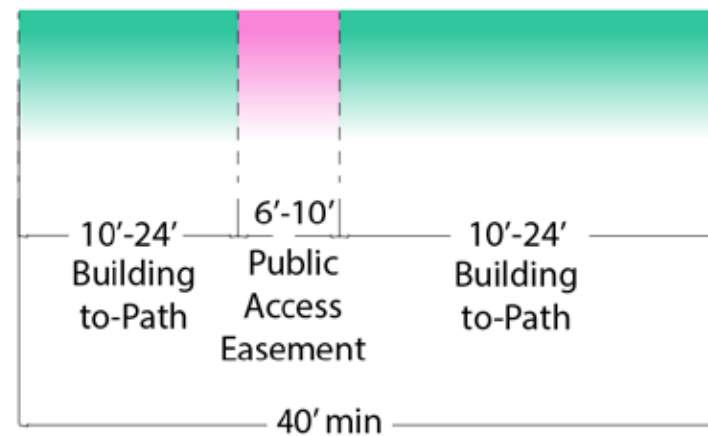
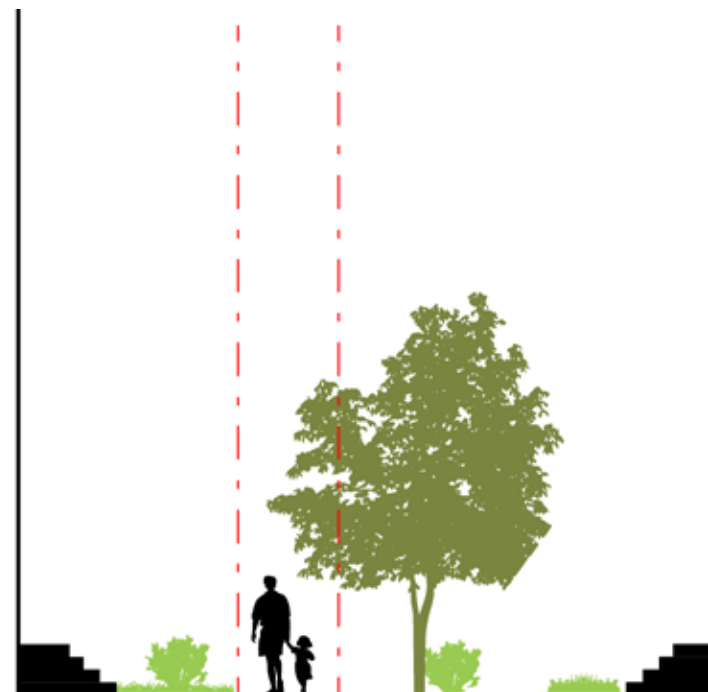

Figure 7.4.3 Residential Paseos

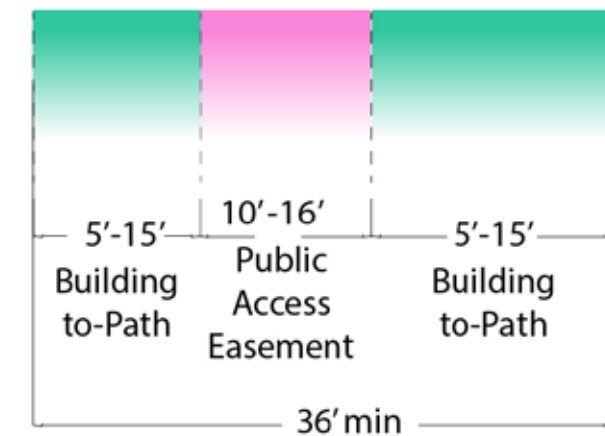
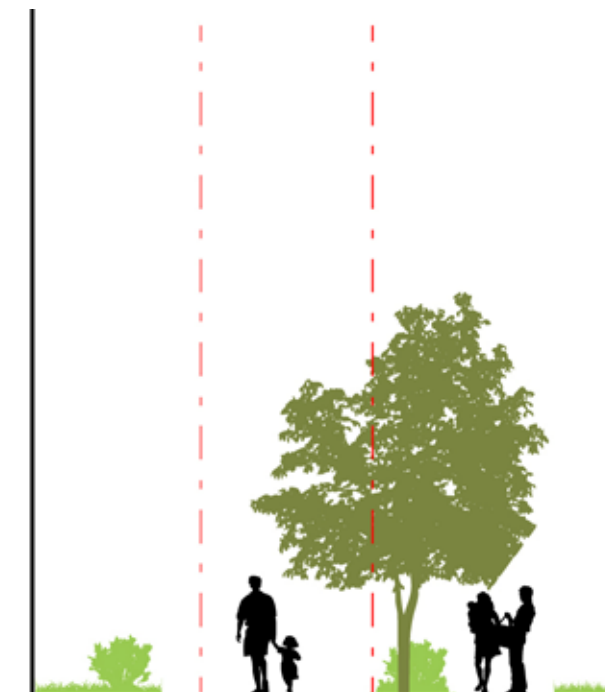

Figure 7.4.4 Non-residential Paseo

7.5 Bicycle network

Regional connections

Building on the bike network improvements identified in the EWPP and VTA’s Santa Clara Countywide Bike Plan (2018), Middlefield Park reinforces access to key cross-region routes. Expanding the Hetch Hetchy Trail eastward into Middlefield Park provides a low-stress, off-street connection to the 21-mile-long Stevens Creek Trail. The Project proposes to dedicate land to the City of Mountain View to contribute to the implementation of a Class I shared-use path between Ellis Street and Clyde Avenue via the future bridge across the VTA tracks and future multi-use path to be implemented by the City through Maude Park. The Project will provide multi-use paths in the following locations: north side of the O5/P1 buildings, on the south side of the P2 parking structure, between O3/O4, and portions between R3/R4(a+b)/R5.

A new north-south shared-use path will also be implemented through Ellis Park, replacing the existing multi-use path parallel to the VTA tracks. The Project also proposes a new pedestrian mid-block crossing on Middlefield Road connecting the Ellis Park multi-use path to the existing multi-use path south of Middlefield Rd parallel to the VTA tracks and future protected bike lanes on Middlefield Road.

The Project proposes implementation of Class II buffered bike lanes on both sides of the Project site frontages of Logue, Clyde, and Maude Avenues. The proposed Maude Avenue improvements will connect to future Maude Avenue bikeway improvements into the City of Sunnyvale at the SR 237 interchange.

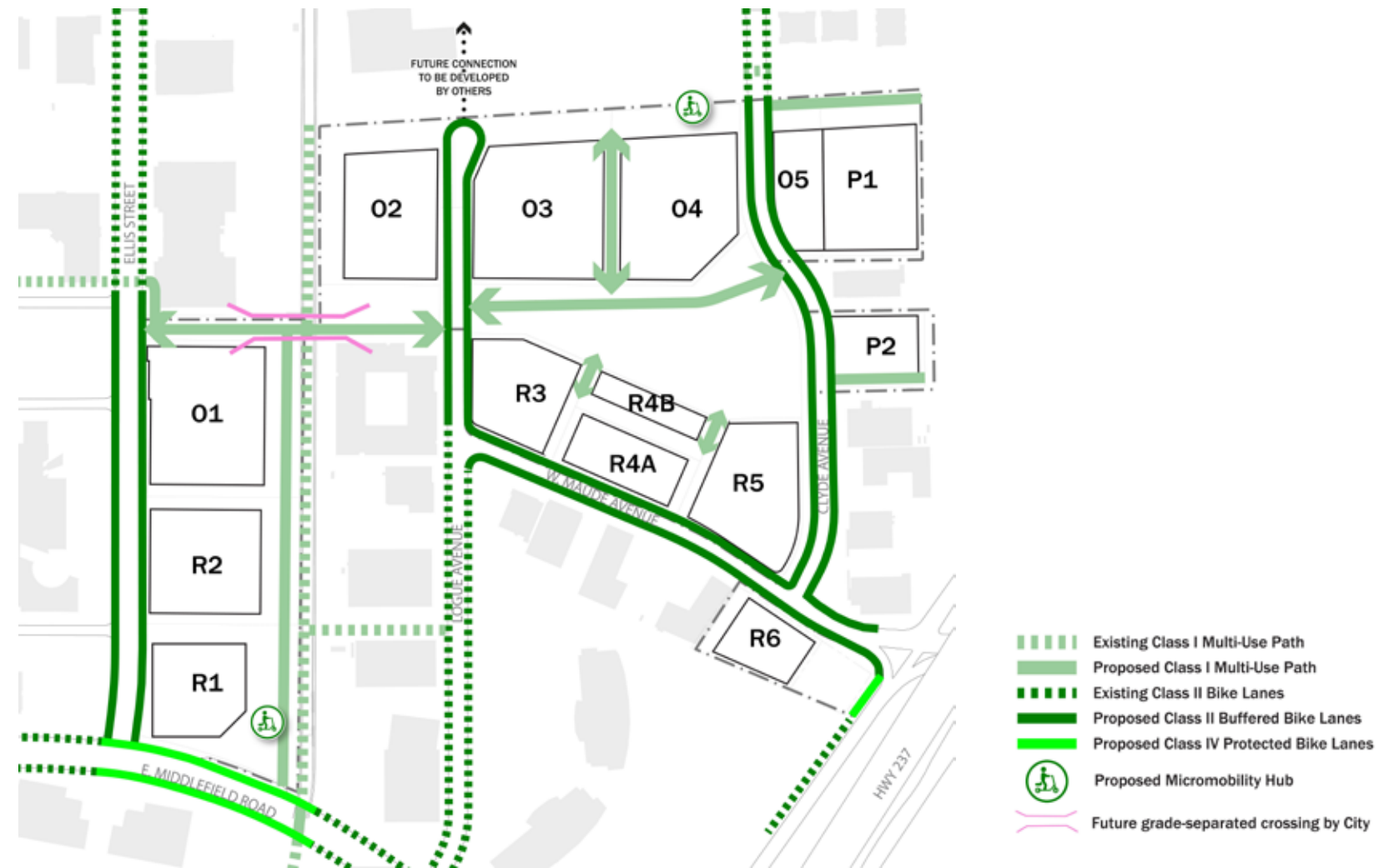

Figure 7.5.1 Proposed bike network improvements

Safety and design

Bike infrastructure throughout Middlefield Park follows best practices to prioritize the safety of all road users and support conversion of auto trips to bike trips. The Middlefield Park Project supports the implementation of new Class I multi-use paths, Class II buffered bike lanes, and Class IV separated bikeways where feasible.

Class I multi-use paths are off-street routes that provide safe, comfortable opportunities for bikers of all ages and abilities. Based on EWPP guidance, the Middlefield Park Project proposes new Class I multi-use paths traversing Ellis Park, and supports the Hetch Hetchy TOD Trail extension and implementation of a future pedestrian and bicycle bridge over the VTA rail corridor. The Middlefield Park project proposes Class II buffered bicycle lanes along the project

site frontage segments of Ellis Street, Logue, Maude, and Clyde Avenues. Class IV protected bike lanes are proposed along the Middlefield Road site frontage.

To minimize potential conflict between bikes and pedestrians, shared off-street routes will clearly demarcate between modes. Where on-street loading/parking zones are required adjacent to bike lanes, they will be designed for maximum protection for all users by providing a 3-foot buffer between the bike lane and parking/loading lane. See the Curb Management Plan (Section 7.10).

Bicycle parking

Office and residential buildings in Middlefield Park will meet minimum EWPP bike parking requirements (see Table 7.5.2). All buildings will include short-term parking, with more at shuttle stops, cafés, gyms, and entrances to

other large gathering spaces. Short-term storage will be designed and located in centralized areas to facilitate activation by features, such as coffee carts, cafés, major pathways, and informational displays. Long-term parking consists of a secure, covered storage room or secure locker, and 20 to 25 percent of secured spaces will accommodate e-bike charging.

Clearly demarcated bike parking near building entrances will accommodate easy bike access for trips within Middlefield Park. Furthermore, bike- and scooter-share programs will include micromobility hubs that will be strategically located throughout the site as illustrated in Figure 7.5.1.

Office buildings will contain 1 unisex shower for the first 80,000 sf and 1 additional unisex shower for each additional 40,000 sf of building area.

Table 7.5.2 Bicycle parking per land use

Land Use	Long-term (secured)	Short-term
Residential	1 per unit	1 per 10 units
Office	1 per 2,000 GSF minimum 4 spaces ¹	1 per 20,000 GSF minimum 4 spaces ¹
Active Uses	1 per 5,000 GSF minimum 2 spaces ¹	4 per 5,000 GSF minimum 2 spaces ¹

Source: EWPP

¹ Whichever is greater

7.6 Transit network and stops

Public transit

The Project is designed to reinforce and improve pedestrian and bicycle access to existing bus stops and VTA Middlefield Station. Implementing new office, residential, and retail development within a 10-minute walk of the VTA Middlefield Station and surrounding bus stops, as proposed by the Project, is expected to increase public transit demand.

The Project will also enhance existing bus stops on westbound Middlefield Road just east of Ellis Street and on westbound Maude Avenue just west of Clyde Avenue. Specifically, the Project will provide shelters and benches at both bus stops. In addition, the Project will implement a bus island with protected bike lane along the westbound Middlefield Road bus stop, which will be designed to accommodate new fire lane access and the proposed mid-block crossing.

Furthermore, the Project's TDM programs could provide subsidized or discounted transit passes, improved first-mile/last-mile connections to transit, and increased marketing in order to incentivize transit use for employees and residents of Middlefield Park.

GBus shuttles

Car traffic will be reduced as Google expands the GBus shuttle program to accommodate growth at Middlefield Park, as each shuttle takes 25 to 50 cars off the road. A new employee GBus shuttle stop is proposed on the O3/O4 private service street between Logue and Clyde Avenues.

7.7 Street network

Middlefield Park will be designed with a Complete Street network to support all modes of travel.

Improvements to existing streets

The Middlefield Park Project will upgrade existing streets along the Project site frontages on Ellis Street, Middlefield Road, Logue, Maude, and Clyde Avenues to comply with the EWPP recommendations for sidewalks, landscaped buffers, travel lanes, and Class II buffered bike lanes. The Project proposes enhancing the bikeway design on the Middlefield Road site frontage to include Class IV protected bike lanes in both directions along with upgraded bus boarding island in the westbound direction.

New local streets

The project will extend Logue Avenue north to the SFPUC easement, where a cul-de-sac will be provided. The Logue Avenue extension is also referred to as “Street D” in the EWPP. The Street D extension to Clyde Court across the SFPUC easement is expected to be implemented by others when development occurs on the properties north of the easement. An east-west service street is proposed just south of the SFPUC easement, connecting the O2 building to the Logue Avenue extension, and to Clyde Avenue.

The EWPP also recommends the provision of a new vehicular north-south Street C connecting Maude Avenue to the SFPUC easement between Logue and Clyde Avenues. However, per the EWPP, a greenway, paseo, or multi-use path may be provided in lieu of Street C if a master plan application is submitted by all affected property owners and the City makes a finding that Street C is not necessary for vehicular circulation, utilities or other functions. In lieu of a vehicular Street C, the Project will provide publicly-accessible north-south multi-use paths between the O3/O4

and R3/R4(a+b)/R5 buildings, providing access to and through Maude Park.

The north-south connections will provide adequate pedestrian and bicycle connectivity. A new Street C is not necessary for vehicular circulation for new developments in the area bounded by Logue, Maude, and Clyde Avenues as vehicular access will be provided via the proposed service streets or existing public streets.

New service streets

Service streets are slower, narrower streets that serve a variety of purposes: access to parking garages, addresses for residential units, commercial, loading/delivery, emergency vehicle access, and more. These streets include sidewalks, trees and landscaping, and bicycles may share the travel lane with slow-moving vehicles. New private service streets are proposed adjacent to the following buildings (and shown on Figure 7.7.1):

- O1/R2 building service street with access via Ellis Street;
- O2 building service street with access via Logue Avenue/Street D extension;
- O3 and O4 building service street with access via Logue Avenue/Street D extension and Clyde Avenue;
- R3/R4(a+b) building service street with access via Maude Avenue;
- R4(a+b)/R5 building service street with access via Maude Avenue;
- O5/P1 service street with access via Clyde Avenue.



Figure 7.7.1 Street network typology

CIRCULATION + MOBILITY

In addition to Service Streets, direct driveway access is proposed at the following locations:

- R1 with right-turn in and out restricted access via Ellis Street;
- R6 with access via Maude Avenue;
- P2 with access via Clyde Avenue.

All site access Service Streets and driveways will be designed to provide adequate sight distance.

Building loading and servicing

Loading docks will be accessed via the proposed service street/private driveway connections between the buildings shown in blue in Figure 7.7.2. In order to access these driveways for

loading and servicing, trucks will need to be routed through the campus area. For ease of vehicle operations, it is recommended that these trucks stay on major roads, avoid tight right turns, and do not enter dead end roads.

Driveways are also used for access to basement and podium parking for buildings. The Project will prioritize minimizing off-street and on-street loading activities during peak periods to reduce potential conflicts between parking access and truck loading maneuvers; with the exception of trash collection trucks, which are not a timed service. Use of flaggers will also be considered to safely manage truck loading activities for off-street loading facilities during peak periods.



Figure 7.7.2 Truck access and routing

Emergency vehicle access

Emergency vehicle access (EVA) roads will have a minimum 26-foot clear unobstructed width. Several EVA roads will be hardscaped in open space areas in order to locate the EVA roads within a 150-foot travel distance of all exterior building walls. Any EVA road that has a dead end and exceeds 150 feet in length will include an approved turnaround. See Section K of the Implementation Plan for the Conceptual Fire Access and Hose Pull Lengths Plan, Hydrant Spacing, and Conceptual Fire Water Piping and Appurtenances. See the Section L of the Implementation Plan for dimensioned plans of the Logue Avenue turnaround showing fire truck turning analysis for fire and refuse trucks.

Upon further refinement of building design additional EVA features may be required. Buildings that are greater than 30 feet in height, expected for most buildings, will require a minimum of two EVA roads. One of the required EVA roads will have 26 feet in unobstructed width parallel to one side of the building and will be set back from the building face by 15 to 30 feet, as determined by the City's Fire Protection Engineer.

EVA routes shall not conflict with the pedestrian-bicycle bridge proposed.

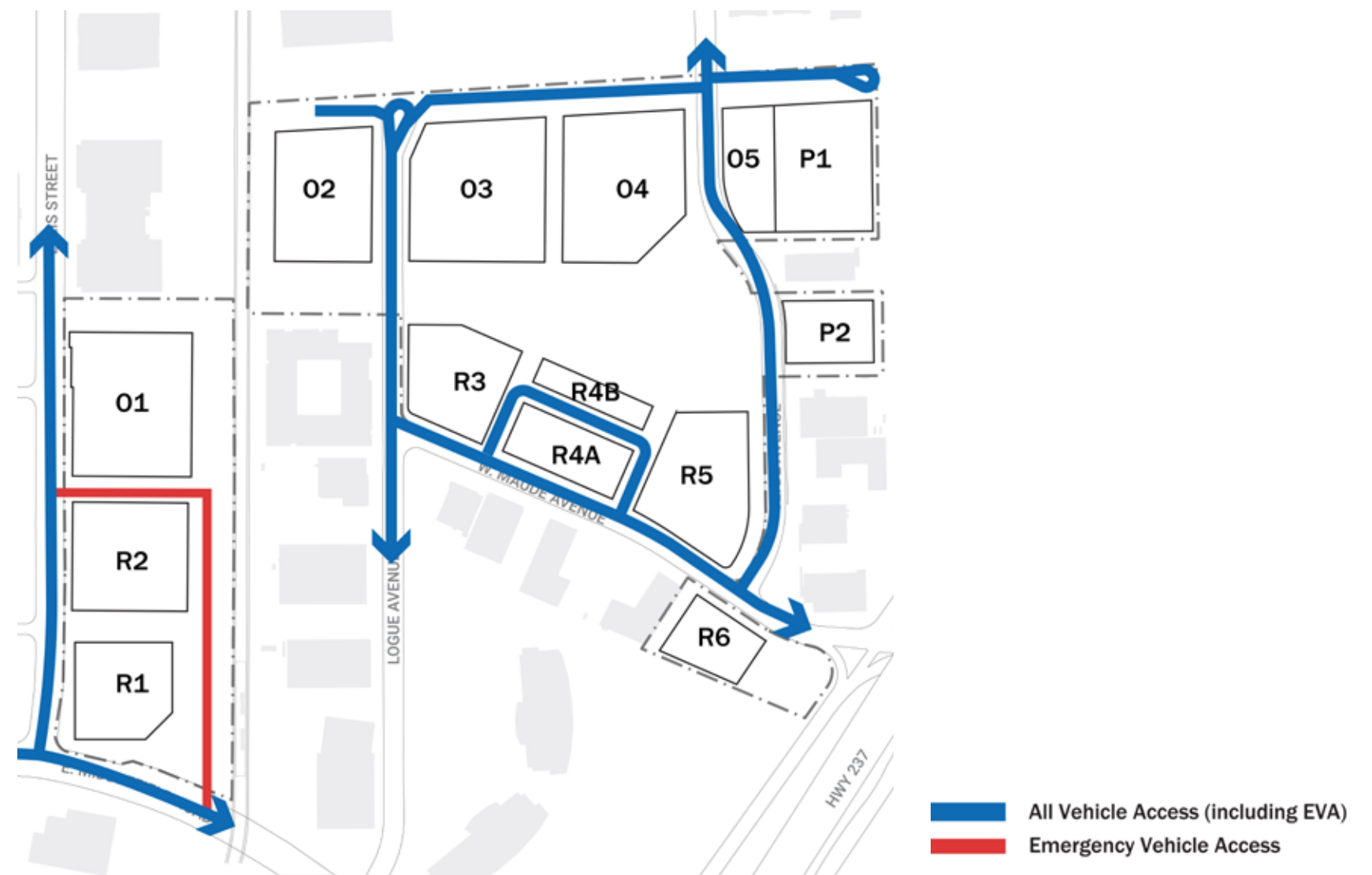

Figure 7.7.3 EVA network

7.8 Street design

Middlefield Road

Middlefield Road serves as an east-west avenue passing through the center of the East Whisman planning area and will serve transit, autos, bicycles, and pedestrians. Figure 7.8.1 shows the proposed cross-section from the EWPP, which will remain 80 feet curb-to-curb. With the existing 100-foot public ROW, a 4-foot easement will be provided on the north side of the street along the Project frontage. The street easement is needed to accommodate expanded sidewalks (8 feet) and landscaping buffer (6 feet). The roadway will include two travel lanes, a median with left-turn lanes, and protected bicycle lanes.

The Middlefield Park Project proposes to enhance the bicycle experience by adding flexible delineators or curb, where appropriate, to the buffered bicycle lanes. This proposed enhancement is part of Google's effort to expand the use of bicycles within the EWPP area. The Middlefield Park Project proposes to improve the segment of

Middlefield Road along the Project site frontage, including a new bus stop location, midblock crossing and bike and pedestrian facilities.

Ellis Street

Ellis Street serves as a north-south Avenue passing through the center of the East Whisman planning area and will serve transit, autos, bicycles, and pedestrians. With its connection to US 101 to the north, Ellis Street serves as a key access point for regional traffic to the EWPP area and provides a route to connect with Google campuses in Moffett Park and East Whisman. The Middlefield Park Project supports the implementation of the Class II buffered bike lanes in each direction of Ellis Street; this design will enhance the bicycle network connections between the Stevens Creek Trail, the Hetch Hetchy trail, and the future intersection improvements for pedestrians and bicyclists planned on the west side of the Ellis Street at the US 101 undercrossing (a project led by the City of Mountain

View). This City-led project will also connect to the Google-funded shared-use path along the north side of Manila Avenue, which will extend to Moffett Park. The Ellis Street buffered bike lanes would be integrated into a larger regional network for bicycle access around, in, and through the EWPP area. As shown in Figure 7.8.2, the proposed Ellis Street design concept would fit within the existing curb to curb dimension of 70 feet. With the existing 90-foot public ROW, a 4-foot or 9-foot street easement is needed to accommodate the 14 feet of sidewalk and landscaped buffer required behind the curbline. The Middlefield Park Project proposes to improve the segment of Ellis Street along the Project site frontage. The Project proposes sidewalk improvements only on the east side of the street along the Project site frontage.

Logue, Maude, and Clyde Avenues

Logue, Maude, and Clyde Avenues are local streets providing development access in the EWPP area that will primarily serve autos, bicycles,

pedestrians, and potentially transit. The existing roadways provide one travel lane per direction, Class II bicycle lanes and parking on both sides. The long-term proposal for the roadways is to remove parking on one side of the roadway in order to implement Class II buffered bicycle lanes on both sides. Figure 7.8.3 shows the proposed cross-section from the EWPP; the curb-to-curb width will remain 50 feet.

With the existing 70-foot public ROWs, a 2-foot street easements is needed on both sides of the roadway. The street easements are needed to accommodate expanded sidewalks (7 feet) and landscaping (5 feet). The roadway will include one travel lane per direction, one parking lane, and buffered bicycle lanes along both directions. The Project will improve the Logue, Maude, and Clyde Avenue segments along the Project site frontages only.

State Route 237 Collector-Distributor Road

The State Route 237 Collector-Distributor Road is a one-way two-lane southbound street that connects the westbound SR 237 off-ramp at Maude Avenue to the westbound SR 237 on-ramp at Middlefield Road. The Middlefield Park project will accommodate future two-way cycletrack (also categorized as Class IV protected bicycle lanes) and sidewalk improvements planned by the City of Mountain View on the west side of the street. A 10-foot street easement is needed to accommodate planned improvements while maintaining the existing two southbound travel lanes.

Service streets

Private service streets provide vehicular access from public streets to a number of buildings on the site. These service streets provide: access to off-street parking and loading zones; space for trash and recycling service providers; and access for emergency vehicles.

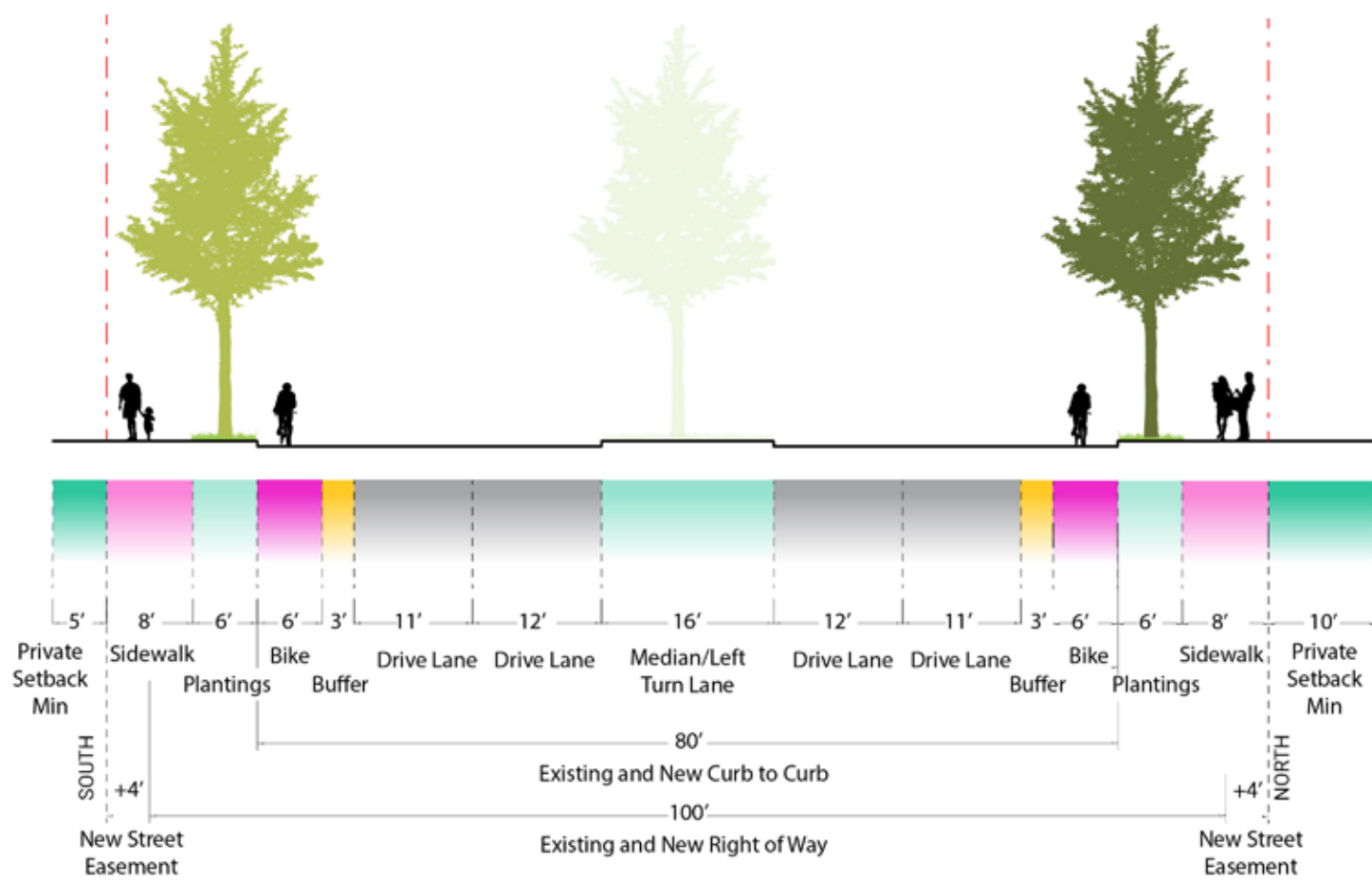

Private setback minimum is dependent on active or non-active priority building frontage.

Figure 7.8.1 Typical section — Middlefield Road

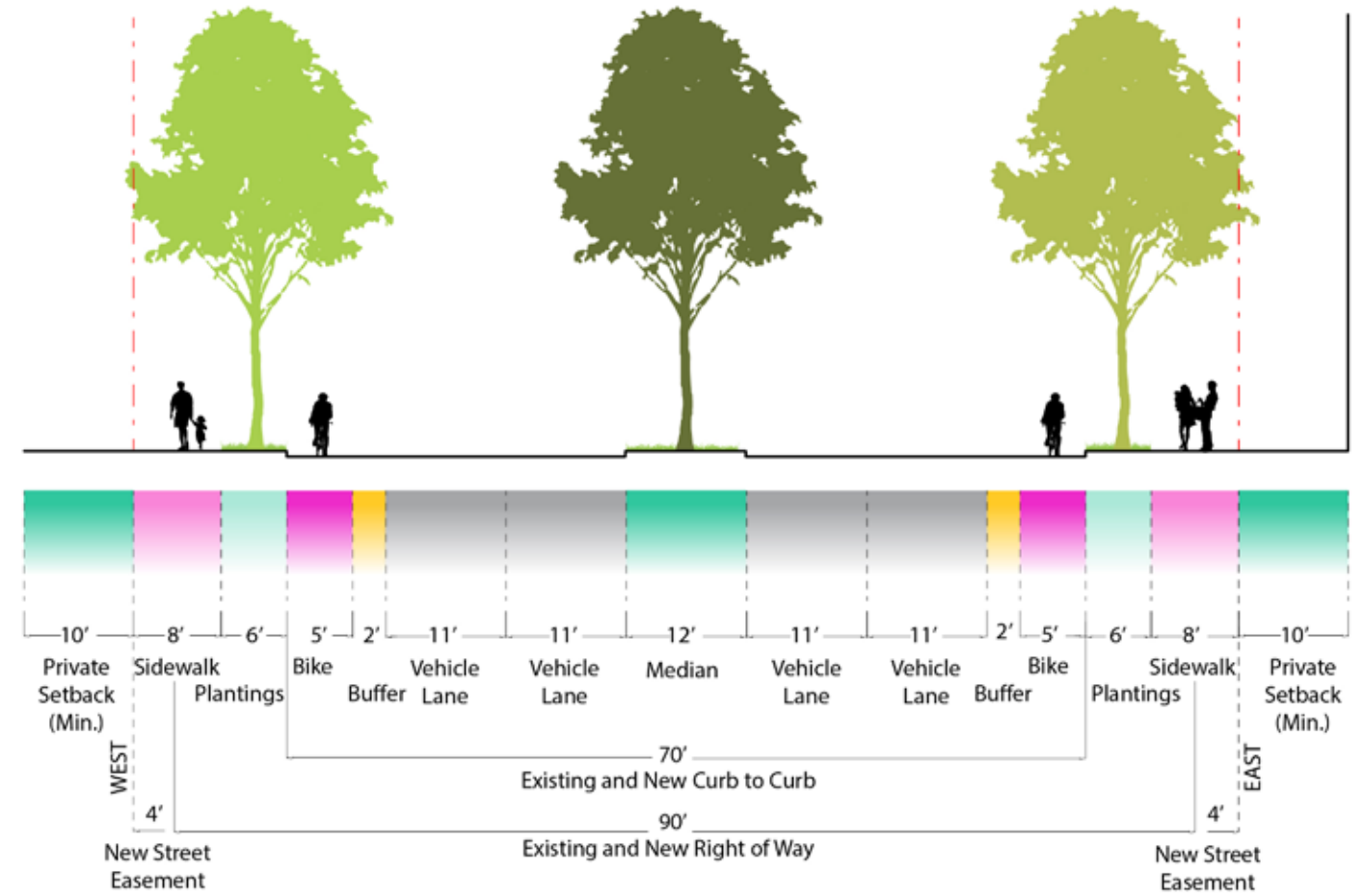

Figure 7.8.2 Typical section — Ellis Street

CIRCULATION + MOBILITY

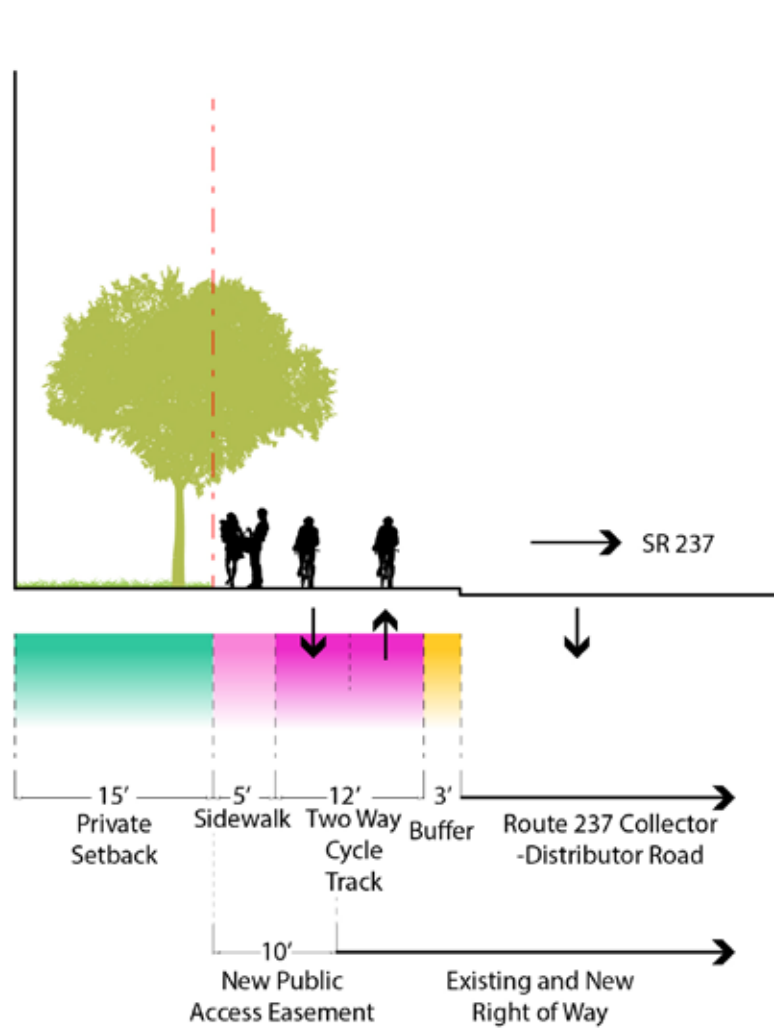
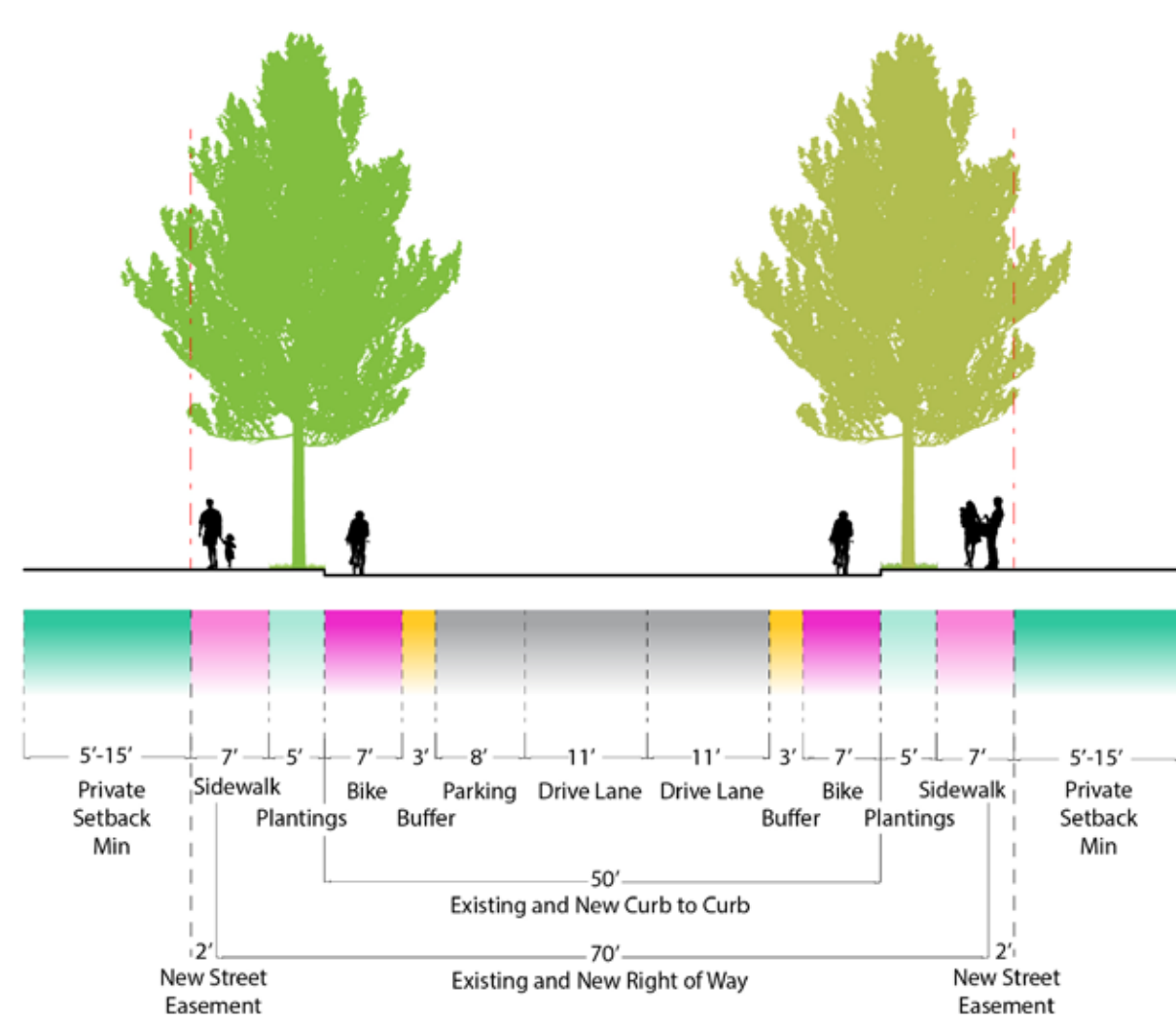
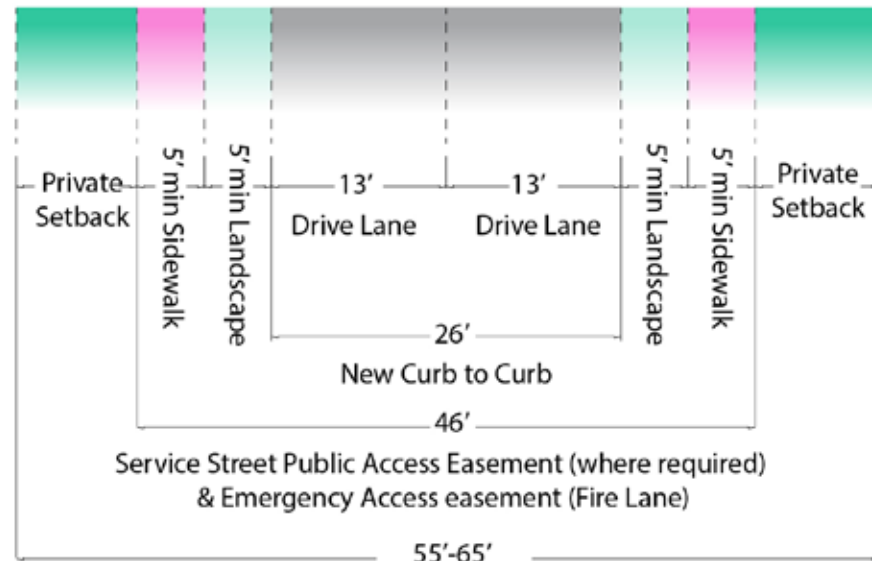

Figure 7.8.3 SR 237 frontage road with two-way cycle track



Note: Parking location is representative, but could be considered for either side of street. Private setback dependent on active vs. non-active frontage and Sub-Character Area.

Figure 7.8.4 Typical section — Logue, Maude, and Clyde Avenues



Building to Building Setback,
Dependent on Frontage Type

Private setback based on active vs. nonactive priority building frontages.

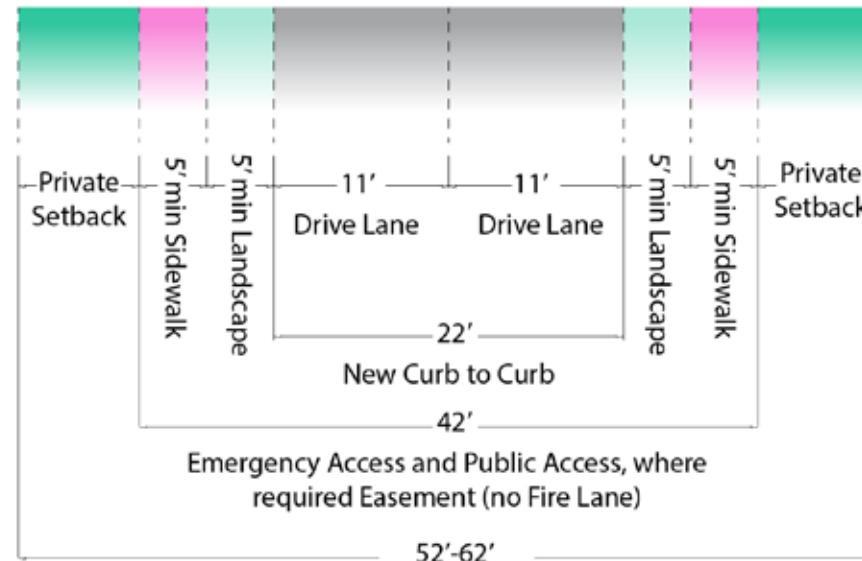

Building to Building Setback,
Dependent on Frontage Type

Private setback based on active vs. nonactive priority building frontages.

Figure 7.8.5 Typical sections — Service Streets

7.9 Parking strategy

The main goal of the Middlefield Park parking strategy is to reduce the parking demand by controlling the supply and providing required TDM programs. Off-street surface parking will be removed within the Middlefield Park boundaries and parking will be provided via garage structures instead. This allows land previously used for cars to be re-purposed as open space for employees, residents, and visitors.

Parking locations and capacity

Proposed off-street parking within Middlefield Park is distributed among 12 different garage structures. See Table 7.9.2.

The 12 garages are estimated to comprise a total of approximately 4,325 stalls: 2,675 for office and 1,650 for residential, retail, and community combined. These same totals are listed in Table 7.9.2. The final parking supply will be informed by future parking demand and management studies, in addition to TDM programs that can be implemented to reduce parking demand.

Carsharing, ride sharing, electric vehicle charging, expectant mothers

Dedicated car share spaces will be provided in all garages to meet the EWPP requirements. This includes a minimum of 3 car share spaces in all office building structures and at least 2-3 spaces in all residential building structures, depending on number of parking spaces per building.

The construction of new garages will significantly increase the electric vehicle (EV) parking infrastructure and incentivize electric vehicles through priority space locations. All new parking garages will meet or exceed the minimum EV parking requirements established by the City Building Code at the time of permit application.

Parking access and distribution

Middlefield Park is served by avenues and local streets acting primarily as access routes to and from US 101 and SR 237. Entering and exiting vehicles currently rely on (and are expected to continue using) four primary district gateways.

- Ellis Street (via US 101 and Manila Avenue)
- Fairchild Drive/Clyde Avenue (via Ellis Street)
- Middlefield Road (via SR 237)
- Maude Avenue (via SR 237)

Figure 7.9.4 and Figure 7.9.5, which illustrate approximate AM and PM vehicle access flows to parking,

incorporate the relative use of different gateways and the distribution of vehicle traffic throughout East Whisman. While arrival and departure distributions are varied, the majority of residential traffic is forecasted to exhibit traditional daily directional behavior, with departures in the morning peak and arrivals in the afternoon peak. Conversely, office-bound vehicles would arrive primarily in the morning and depart in the afternoon.

As previously described, the Project proposes a new traffic signal on Ellis Street at the O1/R2 service street. Secondary access to parking structures for residential buildings R1 and R2 will be located further south near R1 and limited to right-turn in/right-turn out movements only. All other parking garages will provide unsignalized full access controls.

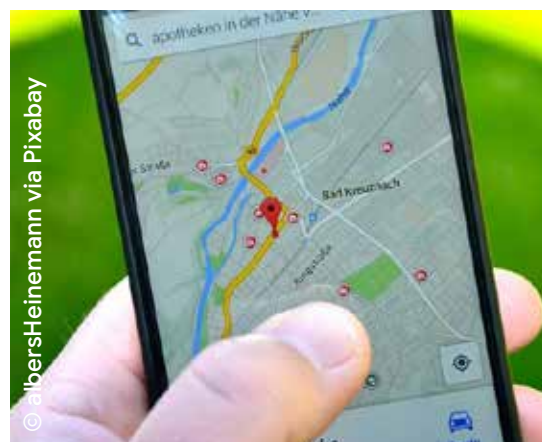

Figure 7.9.1 Examples of parking and car-sharing strategies

Table 7.9.2 Proposed off-street parking ratios	
Land Use	Proposed Parking Ratio
Office	2.0 parking stalls per 1,000 sf
Retail	4.0 parking stalls per 1,000 sf
Community Uses	None, parking will be shared with retail parking
Residential	0.8 parking stalls per dwelling unit
Open Space	None

Note: The Master Plan does not establish a parking ratio for the Project, as parking will be determined at permit entitlement for each phase of development.

Note: Totals are indicative and subject to adjustment with future permit entitlements.

Table 7.9.3 Parking locations and capacity				
Building	Land use	Estimated number of parking stalls	Estimated square footage	
			Above-grade	Below-grade
O1	Office	400 – 450	N/A	160,000
O2	Office	200 – 250	61,000	N/A
O3	Office	150 – 200	48,000	N/A
O4	Office	150 – 200	41,000	N/A
O5	Office	0	N/A	N/A
P1	Garage	1,350 – 1,500	203,000	59,000
P2	Garage	300 – 350	96,000	N/A
Office Subtotal		~2,634		
R1	Residential/mixed-use	300 – 360	39,000	120,000
R2	Residential/mixed-use	300 – 350	36,000	150,000
R3	Residential/mixed-use	200 – 250	32,000	60,000
R4a	Residential/mixed-use	150 – 180	23,000	41,000
R4b	Residential/mixed-use	80 – 95	10,000	18,000
R5	Residential/mixed-use	300 – 320	42,000	81,000
R6	Residential/mixed-use	100 – 150	18,000	16,000
Residential Subtotal		~1,650		
Total		~4,284		

CIRCULATION + MOBILITY



Figure 7.9.4 Approximate AM parking flows and distribution



Figure 7.9.5 Approximate PM parking flows and distribution

Residential Traffic
Office Traffic

7.10 Curb management plan

Transit stops

Locations of MVgo, VTA, and third-party shuttle stops are designed to minimize bike and pedestrian conflicts. Subject to approval by the City of Mountain View and the VTA, the VTA bus stops on westbound Middlefield Road (just west of the VTA tracks) may be designed with a floating passenger loading island to eliminate conflicts between buses and bicyclists. The Middlefield Road bus stop and a VTA bus stop on westbound Maude Avenue (just west of Clyde Avenue) are proposed to be upgraded with shelters and benches for riders.

Private shuttles / GBus

As part of a robust TDM program, Google provides commuter shuttle service for employees. Expected demand for private shuttles will require three bays of 60 feet each for long-distance shuttles and one bay of 35 feet for short-distance intercampus and

local connectors (see Table 7.10.2). A shuttle stop is proposed on the private service street north of O3/O4 and will not conflict with fire access lanes.

Garage drop-off zones

The EWPP requires one standard-sized parking stall per 200 residential units to facilitate pick-up and drop off, short-term parking, loading and deliveries, and one designated moving truck location per residential building. To accommodate passenger loading spaces, 2 loading spaces will be provided within each parking garage in R1 and R2. Passenger loading for O1 will be accommodated via the O1/R2 service street and/or the O1 parking garage.

All other buildings proposed by the project will meet the minimum EWPP passenger loading supply requirements to be accommodated via on-street flex zones, service streets and/or within parking garages.

On-Street flex zones

As described in the EWPP, flex zones dedicate space between vehicular travel and bike lanes for passenger loadings, delivery loading/unloading, shuttle/transit stops and on-street parking. Where possible, passenger loading is provided on-street. Ellis Street and Middlefield Road cannot accommodate on-street loading zones; therefore, freight and passenger loading is proposed within service streets. On Logue Avenue, both O2 and O3 require passenger loading zones; per the EWPP, flex zones serving each building can be located on opposite sides of the street. The EWPP requires a minimum separation of 100 feet between flex zones prior to transitioning to the other side of the street; this requirement is reflected in Figure 7.10.1, which identifies proposed flex zone locations. Final location of flex zones to be determined in future permit entitlements.

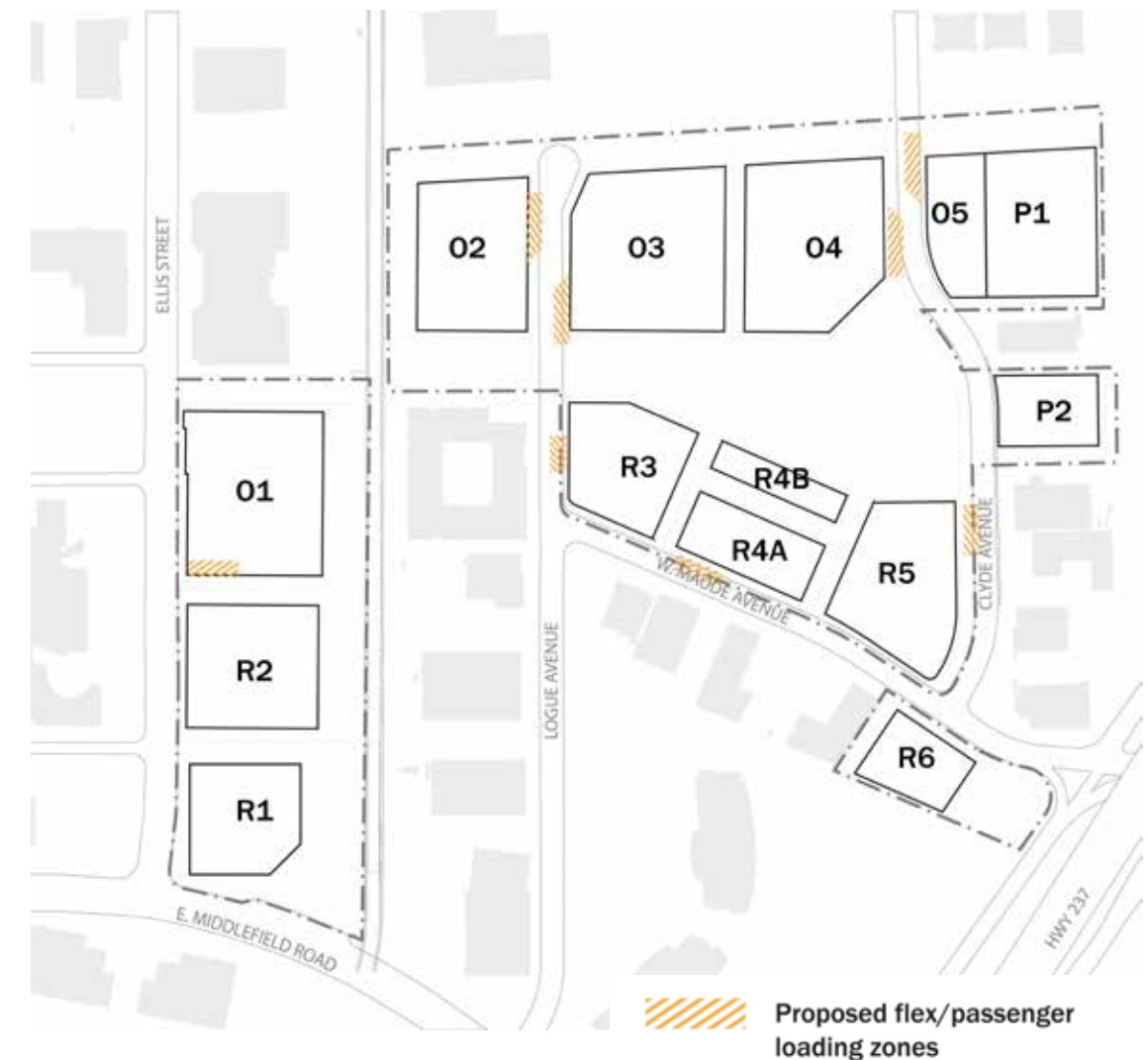

Figure 7.10.1 Curb management plan

Table 7.10.2 Expected loading space for private transit

Shuttle service	Bays required	Total loading space required	Minimum recommended width
Intercity commuter shuttle	3	180 ft	10 ft
Intercampus and local connector	1	35 ft	8 ft

© NACTO

8. BUILDINGS

The Middlefield Park Master Plan will deliver a diverse and context-sensitive built environment that creates a distinct identity and sense of place, utilizing height and density around the key public transit node as a fundamental step in creating a transit-oriented community. To achieve this the Master Plan complies with the Standards and Guidelines of the East Whisman Precise Plan, and provides guidance to future architects of Middlefield Park buildings through the accompanying Implementation Plan's Urban Design Objectives in order to reinforce these goals.

8.1 Architectural vision

The connected tree canopy will be the defining characteristic of the open space experience in Middlefield Park, and will also influence the design of its buildings. Buildings facing Ellis Park and Maude Park will be designed with enhanced openness and transparency, offering the opportunity of visual connection to the canopy from within buildings as well as increased activation and safety within the open space. The canopy also offers the potential for inspiration and connections to biophilic building elements such as green walls and terraces. The shared pedestrian and bike paths that provide access for buildings that front directly onto the open space, also helping to activate the park edges.

Architectural style is intended to be both contemporary and contextually responsive. The project prioritizes designing with locally appropriate materials and proportions derived from environmental and human indicators,

rather than stylistic imitation of architecture from another period.

The design of residential buildings in Middlefield Park will establish a recognizable character. Buildings will address both streets and parks, while framing shared community open space for residents. Building mass will be broken down through variety in materials and facade design so as to provide visual interest and legible wayfinding to individual addresses.

Middlefield Park will see the delivery of Class-A office buildings, continuing to enhance the quality of both the workplace and the architecture within East Whisman. Incorporating high performance passive and active design strategies, in world-class contemporary architectural styles will enable buildings to deliver more natural light to interior workplaces while meeting a host of ambitious sustainability goals.

Diverse building massing and composition

Design controls and guidelines are used to ensure buildings avoid the appearance of merely filling maximum zoning envelopes. The Plan provides for architectural resolution by treating each block as a considered composition of buildings with a variety of heights, materials, and articulations at the street level.

In addition to the MPMP and EWPP, additional information related to the architectural vision for the project can be referenced in the Urban Design Objectives section of the Implementation Plan document.

Integrated sustainability

The integration of sustainability principles into architectural design is a core tenet of the Master Plan. Environmental performance will be a driving factor in shaping the building's form including considerations of solar orientation and massing, facade design, and space planning. Low-carbon, low-water building system design will compliment the efficiencies and performance that could be achieved through a district systems approach, if implemented. All office buildings will achieve LEED Platinum, and all residential buildings will meet or exceed GreenPoint Rating 120+ points or equivalent.

Active and adaptable ground floors

Although there is currently no residential population within the Precise Plan area and little demand for retail, the transformation of the East Whisman area will drive growth and demand for both uses. The MPMP seeks to create vibrant and active ground floor edges onto streets and parks even in its earliest phases. Architecture should therefore aim to maximize the potential activation at ground level, including the allowance for live/work opportunities and the potential for adaptation of ground floors into community space or retail uses suitable for supporting the growth of a diverse range of local small businesses.

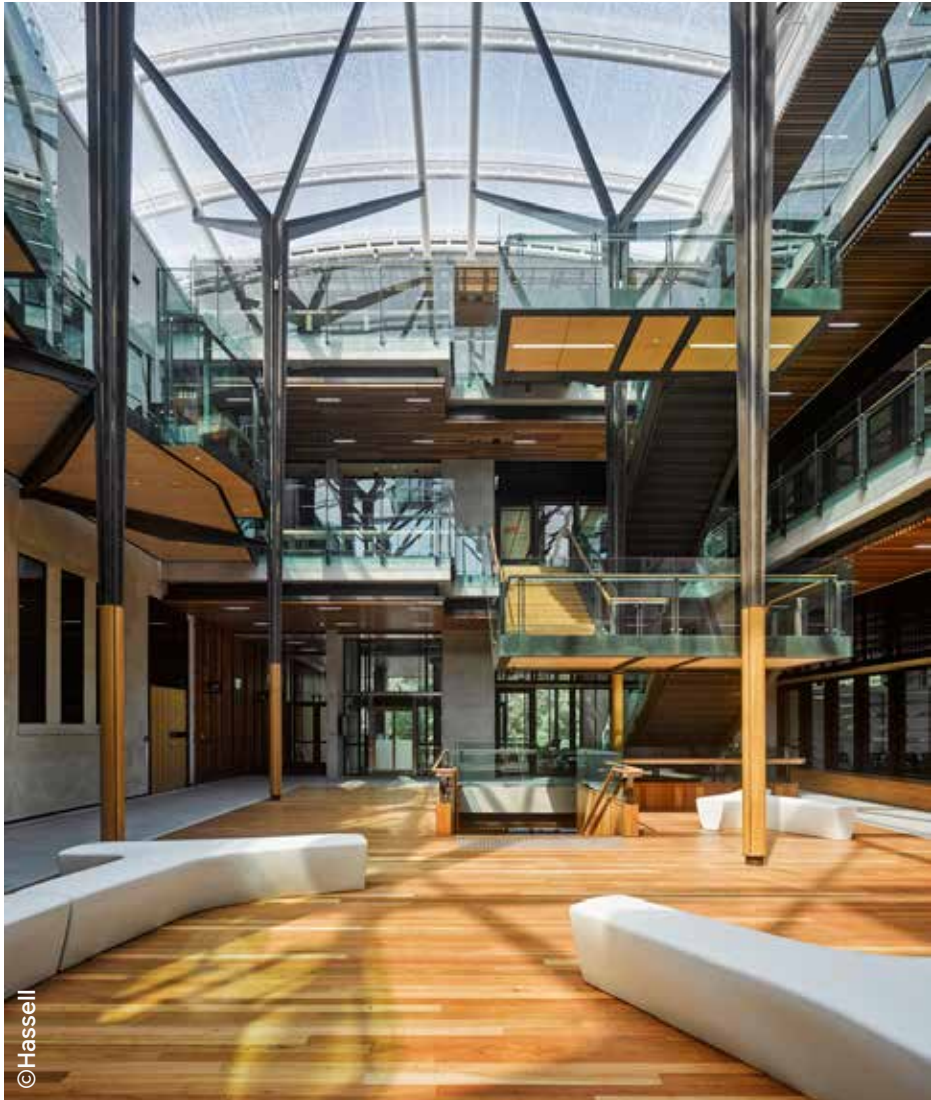

Figure 8.1.1 Building design precedents: buildings will be designed to celebrate sustainability, mimic nature and engage with nearby trees and parks

8.2 Built form approach

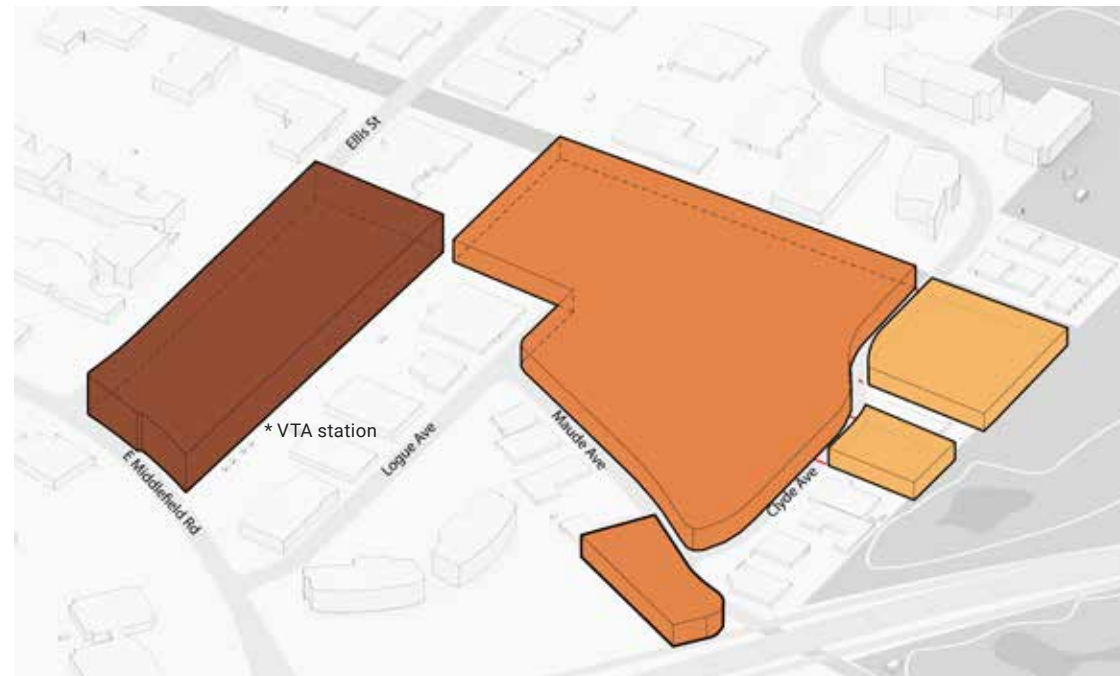

Figure 8.2.1 Height zones

EWPP height zones

Height controls are established by the EWPP, with height bonuses available for residential/mixed use buildings within the walking catchment of the VTA Middlefield Station. Height zones incentivize locating residents close to the station as well as providing neighborhood retail and services on a new plaza adjacent to the station.

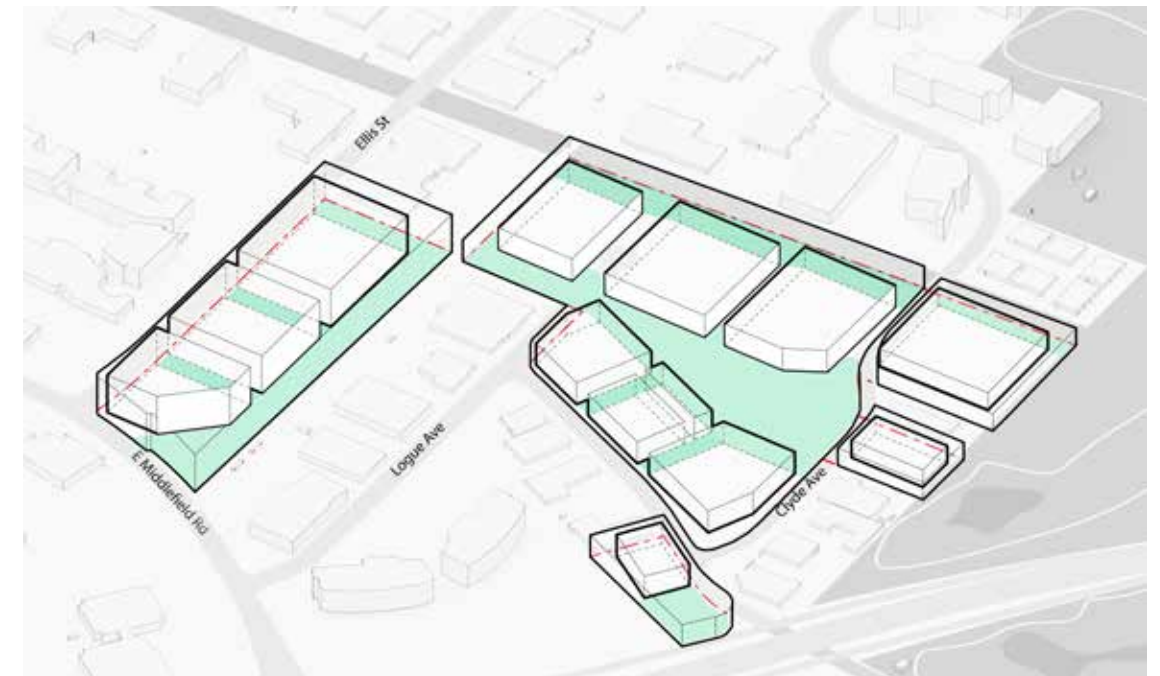

Figure 8.2.2 Development blocks

Development blocks and open space

The block pattern has been established by combining the connectivity desired lines in the Precise Plan with the 400-foot maximum block dimension in the Mixed-Use sub-area, and the geometry generated by the large central Maude Park. A 500-foot maximum block is allowed in the Employment Area North sub-area.

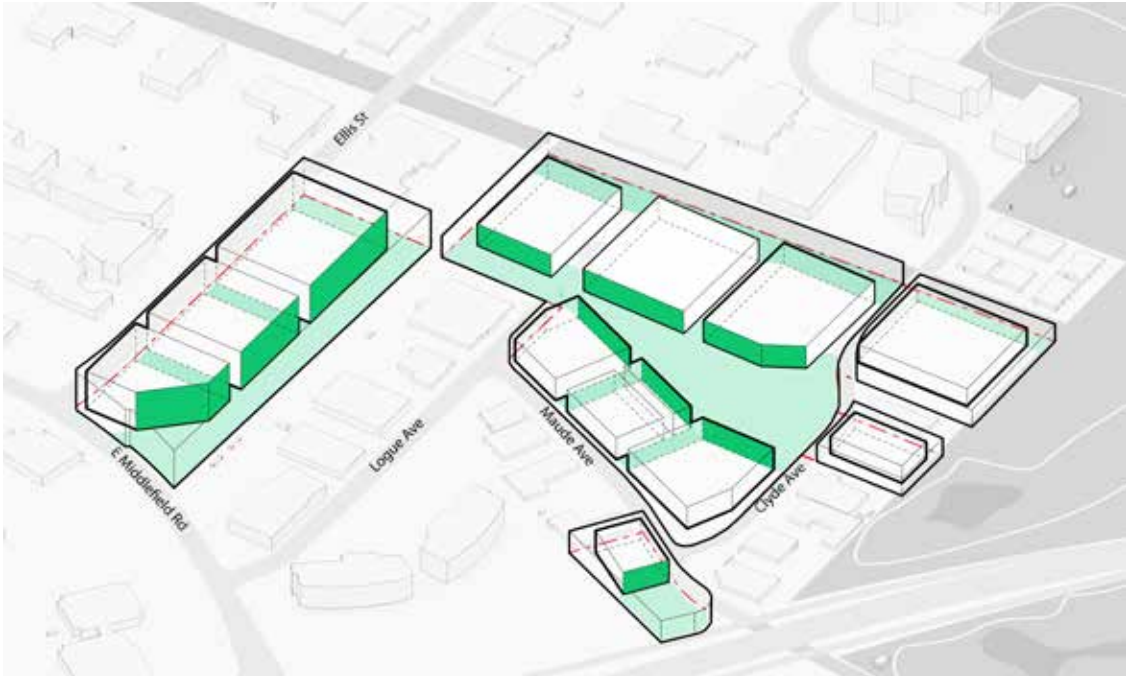

Figure 8.2.3 Open space

Acknowledging open space

Development bulk is further refined by calling out building facades that front the new parks and open space. These facades will include special architectural treatments such as larger windows and upper floor stepbacks.



Figure 8.2.4 Built form

Diversity of built form

All the tools of the EWPP design guidelines and the Urban Design Objectives will be used to further break up the mass of development blocks into identifiable buildings at a human scale.

Within permissible controls, diverse heights are established within each development block, with key corner and streetwall conditions further reducing perceived mass in alignment with the Precise Plan. Shared open space areas for residential and office buildings are in alignment with required design standards.

8.3 EWPP Building Design Standards

The EWPP establishes standards related to allowed development intensity and height, building frontage design and type, building placement, and block size. The development plots in Middlefield Park comply with all of these building standards in alignment with the goal of creating transit-oriented development (TOD) with seamless transitions to surrounding neighborhoods.

EWPP Development Standards, Design Guidelines and the Urban Design Objectives will inform building designs found in the Master Plan. However, major design elements impacting the Master Plan are:

- Maximum height;
- Maximum average street wall height;
- Minimum setbacks.

Note that the Floor Area ratio is addressed in Section 5.7 of this document.

The particular building designs will be addressed through subsequent permit

entitlements. This section additionally provides diagrams of the indicative building envelopes, and studies of the visual impacts of these envelopes from key views around the East Whisman area.

The following sections include excerpted Building Design Standards from the EWPP for reference (shown in blue text boxes), as well as illustrations of where and how these standards apply to the Master Plan and future building designs.

Maximum height

Two height limitations are imposed on the site: those prescribed in the EWPP, and those prescribed in the Comprehensive Land Use Plan (CLUP) for Moffett Federal Airfield. The maximum height defined by the CLUP is 182 feet above Mean Sea Level (MSL), which equates to maximum heights in Middlefield Park of from 123 to 133 feet, measured from existing grades. Within the CLUP’s height restrictions, the maximum heights defined by the EWPP range from 60 feet in the east up to 95 feet in the west. The EWPP also includes a height exception for residential and mixed-use buildings within a 1,000-foot radius of the VTA Middlefield Station, up to a maximum of 135 feet (but in no case greater than the CLUP). The Master Plan incorporates that height exception, and includes the provision of neighborhood commercial uses which are a prerequisite for it.

The EWPP also allows the following height exceptions, which are incorporated into the Master Plan for consideration in future planning entitlements:

- 10 to 15 feet for an additional story, if public parkland is dedicated;
- 10 feet for rooftop amenities (with a Provisional Use Permit) and architectural features;
- 10 feet for architectural features at Key Corner locations;
- 5 feet of additional height for buildings that provide ground-floor neighborhood commercial uses.



Figure 8.3.1 Maximum building height

EWPP 3.3.1.10 and 3.7.3.5
 Pursuant to General Height Standards, Section 3.3.1, provision of neighborhood commercial uses is a precondition for major height exceptions within the high-rise core area.

EWPP 3.3.1.5
 Height Exceptions for Ground Floor Neighborhood Commercial. Buildings with ground floor neighborhood commercial uses may be allowed up to 5 feet of additional height. This exception does not apply to street wall height standards.

EWPP 3.3.1.6
 Projects may receive an additional 10-15 feet of allowable height for one typical additional story if land is dedicated for public parks or other public facilities, subject to approval from the decision-making body.

BUILDINGS

Table 8.3.2 Building heights summary

Building	Moffett Airfield CLUP height limit (above sea level)	Existing grade above sea level (approximate)	Effective CLUP height limit above curb	EWPP maximum building height (measured from top of curb)	Key Corner height bonus	Ground floor neighborhood commercial height bonus	Parkland dedication height bonus	Total proposed height maximums (with height bonuses; not to exceed CLUP limit)
R1 ¹	182 ft	61 ft	123 ft	95 ft	Up to 10 ft	Up to 5 ft	N/A	123 ft
R2 ¹	182 ft	57 ft	123 ft	95 ft	N/A	Up to 5 ft	N/A	123 ft
O1 ¹	182 ft	56 ft	126 ft	95 ft	Up To 10 ft		N/A	125 ft
O2	182 ft	50 ft	132 ft	75 ft	N/A		Up to 15 ft	95 ft
O3	182 ft	50 ft	132 ft	75 ft	N/A		Up to 15 ft	95 ft
O4	182 ft	48 ft	134 ft	75 ft	N/A		Up to 15 ft	95 ft
R3	182 ft	54 ft	128 ft	75 ft	Up to 10 ft	Up to 5 ft	Up to 15 ft	95 ft
R4a/R4b	182 ft	55 ft	127 ft	75 ft	N/A	Up to 5 ft	Up to 15 ft	95 ft
R5	182 ft	56 ft	126 ft	75 ft	Up to 10 ft ²	Up to 5 ft	Up to 15 ft	95 ft
R6	182 ft	57 ft	125 ft	75 ft	Up to 10 ft ²	Up to 5 ft	Up to 15 ft	95 ft
O5/P1	182 ft	47 ft	135 ft	60 ft	N/A		N/A	60 ft
P2	182 ft	52 ft	130 ft	60 ft	N/A	Up to 5 ft	N/A	60 ft

¹ High-rise core height exemption available.

² Additional Key Corner requires design approval in future permit entitlement.

EWPP 3.4.3

Street Wall Height. The maximum average street wall height is in Table 6. Above this height, buildings shall step back 10 feet from public streets and public parks. Taller street wall height may be appropriate to support variation, articulation and interest, but the required average shall be maintained. Building walls within 50 feet of Key Corners are exempt.

Maximum average street wall

The EWPP identifies where maximum average street wall height is set by the requirements of respective Character Areas. The Ellis Street frontage is within the Mixed Use High Intensity Character Area, where the average street wall height is set at 75 feet. Logue Avenue, Maude Avenue, and the west side of Clyde Avenue are within the Mixed Use Medium Intensity Character Area, where the average street wall height is set at 55 feet. The east side of Clyde Avenue is within the Employment Low Intensity Character Area where there is no maximum average street wall requirement. Building wall locations identified within 50 feet of Key Corners within the Master Plan are exempt from these provisions, as acknowledged in the EWPP.

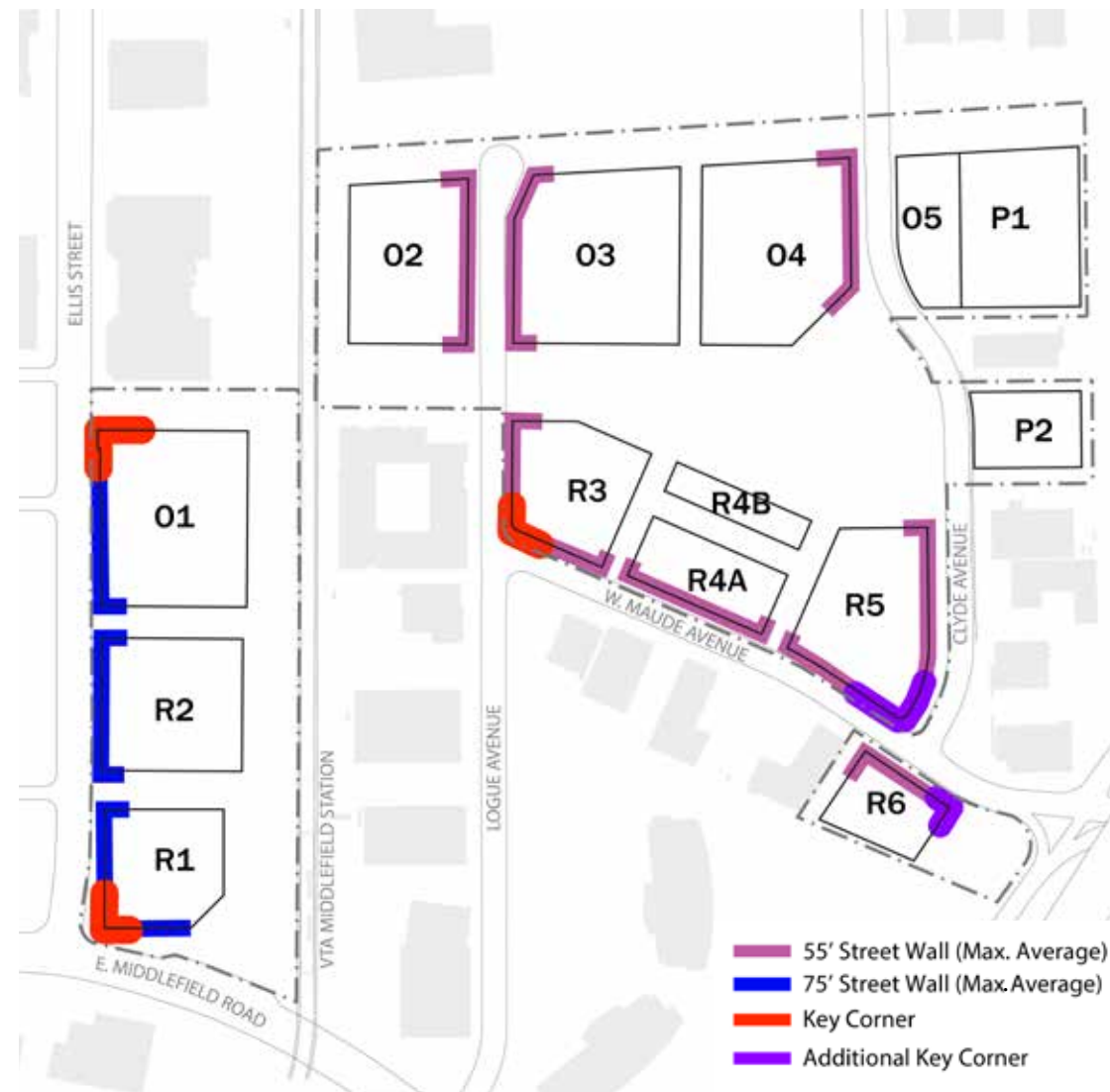
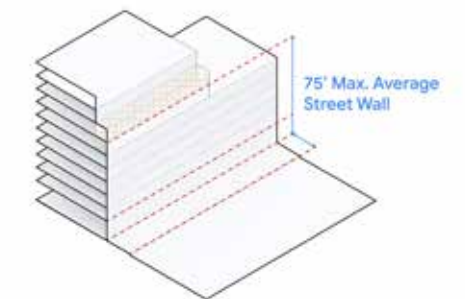
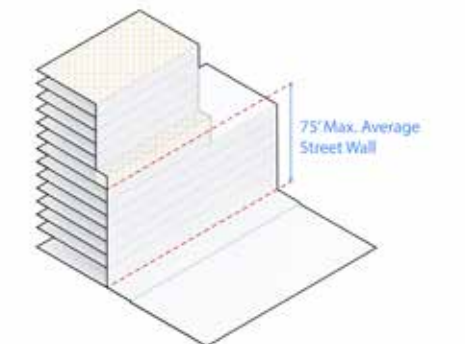

Figure 8.3.3 Maximum average street wall height standards



EWPP 75-foot street wall on office building



EWPP 75-foot street wall on high rise residential

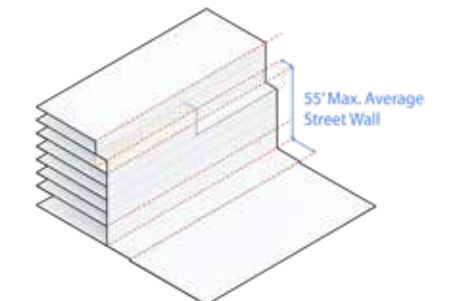

EWPP 55-foot street wall on office building

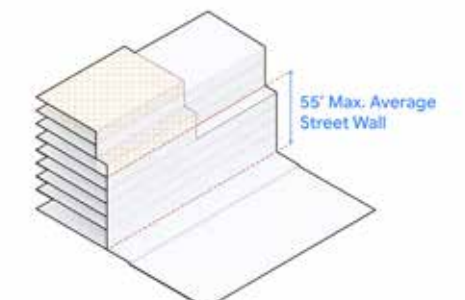

EWPP 55-foot street wall on residential building

Figure 8.3.4 Maximum average street wall height standards in axon

BUILDINGS

Minimum setbacks

The following building setbacks are proposed across the Master Plan in compliance with the EWPP. A 10-foot setback is required along Ellis Street, Logue Avenue, Maude Avenue, and Clyde Avenue, except a 15-foot setback is required for the P2 parking structure on the east side within the Employment Character Area. These are defined by the use and character areas within Chapter 3, Table 7 of the EWPP. Buildings with active priority frontages may have a minimum setback of 5 feet.

In alignment with the Precise Plan, landscaping, residential gardens, and stoops are proposed within these setbacks to manage a transition from the streetscape to the building edge, but will not encroach into the sidewalk or any easement areas.

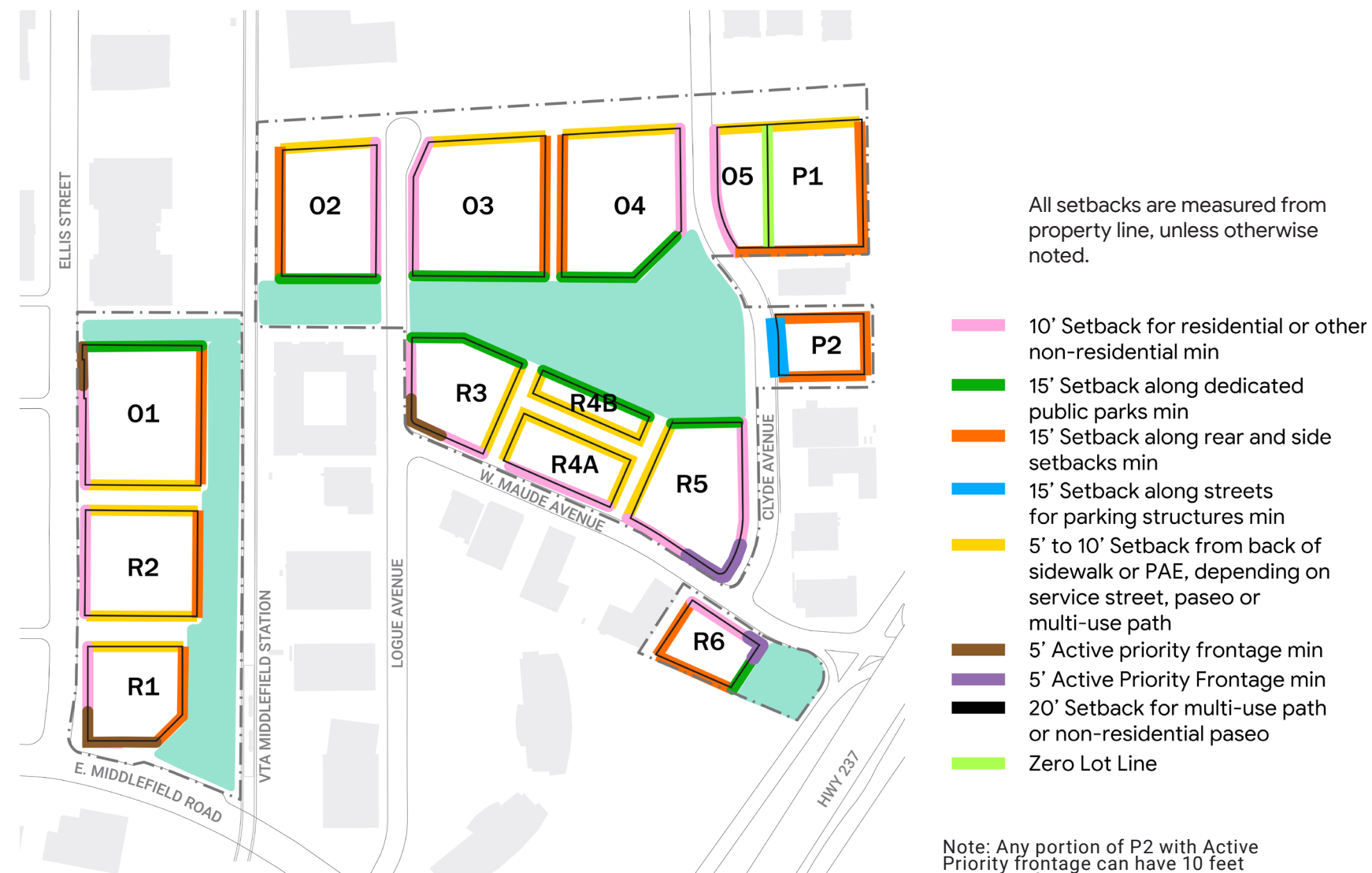

Figure 8.3.5 Setback standards applied to the Master Plan

EWPP 3.3.4.1

Setbacks. Minimum setbacks are established within each Character Area's standards. Setbacks from streets and other network types are measured from the edge of the access easement or public right-of-way, or total width, as shown in the Mobility Chapter. Side and rear setbacks, where no transportation facility is provided, are measured from the property line. Development shall comply with all setback and building placement standards for future planned streets, even if the street is not constructed with the project. Pedestrian, bicycle and vehicle visibility shall be considered at corners and intersecting paths, roads, streets, alleys, and driveways.

Indicative development envelopes

The Master Plan applies the EWPP standards to establish building envelopes, within which future architects will develop building designs. These envelopes give a sense for floor area distribution and overall mass across this Master Plan, while building designs will bring further detail to each development site in alignment with the EWPP design guidelines. Figure 8.3.6 illustrates one potential way buildings may be placed and designed within the resulting development envelopes.



Figure 8.3.6 Indicative development envelopes

BUILDINGS

Visual studies

The digital illustrations included here illustrate the maximum building envelopes in the Master Plan from the key locations within the EWPP. They further demonstrate that the proposed massing supports the hierarchical placemaking goals of the EWPP through variation in height and building differentiation. The concentration of density around the VTA Middlefield Station is balanced by variation of building heights stepping down to the plaza and community park.



Clyde Avenue Northeast looking south



Ellis Street looking south near 475 Ellis



VTA tracks looking north

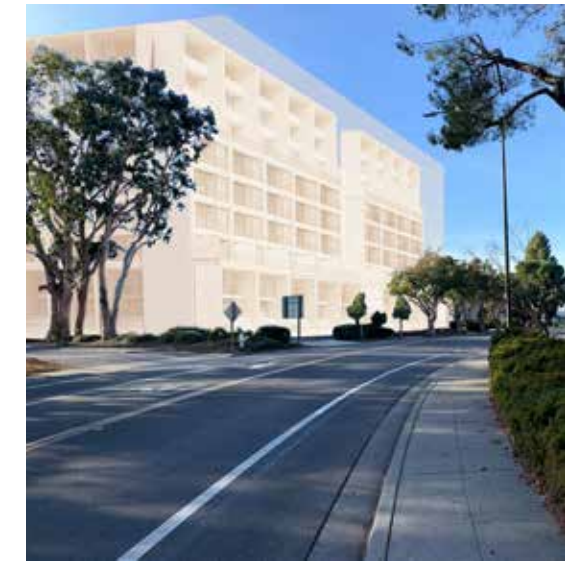

Looking west toward R6



Ellis Street and Middlefield Road looking east



Ellis Street and Middlefield Road looking west near VTA tracks



Ellis Street looking east towards bridge



Whisman Road at Middlefield looking east



Clyde Avenue looking south



Looking east along Middlefield Road at Whisman Road



Middlefield Road looking west across SR 237



From SR 237

Figure 8.3.7 Visual studies

8.4 Solar studies

The following compositions illustrate the potential solar impacts throughout the year on potential building massings within the Master Plan.



Summer Solstice



Fall Equinox



Winter Solstice



Spring Equinox

Figure 8.4.1 Solar studies (massing is illustrative and subject to change)

8.5 EWPP Building Design Guidelines

This Master Plan has been prepared in alignment with the goals of the EWPP Building Design Guidelines. New buildings in Middlefield Park will be designed to deliver on the goals of those guidelines and reflect the opportunities offered by the unique building sites created by the Master Plan. Several provisions within those guidelines are highlighted here because of their influence on the content of the Master Plan and on future building design, and to explain where these guidelines can be furthered by innovative architectural design.

All EWPP Design Guidelines will inform the building designs found in the Master Plan; however, specific guidelines impacting the Master Plan are:

- Key Corner design;
- Corner buildings;
- Buildings' relationship to open space;
- Differentiating buildings;
- Building massing.

The particular building design will be addressed through subsequent permit entitlements. The following sections include excerpted Building Design Guidelines from the EWPP for reference (shown in blue text boxes), as well as illustrations of where and how these standards apply to the Master Plan.

Key Corner design and corner buildings

The Master Plan will deliver on the Precise Plan objective of using Key Corner design to assist in wayfinding

and placemaking. Three Key Corners are identified in the EWPP, all located on significant street approaches to the site. Two additional key corners have been identified within the Master Plan to reinforce this design principle. The three EWPP Key Corners are at the intersection of Middlefield Road and Ellis Street, at the northwest corner of Office building 1 on Ellis Street, and at the intersection of Logue and Maude Avenues. The two additional Key Corners are at the intersection of Maude Avenue and Clyde Avenue. These key corners are proposed in order to amplify the experience of entering into the Master Plan and Precise Plan area. The approach to these corners across the Master Plan should be diverse and site-appropriate. Whether designed as taller built elements, or using building volume voids or landscape elements, these corners will be given focused attention in future building design.

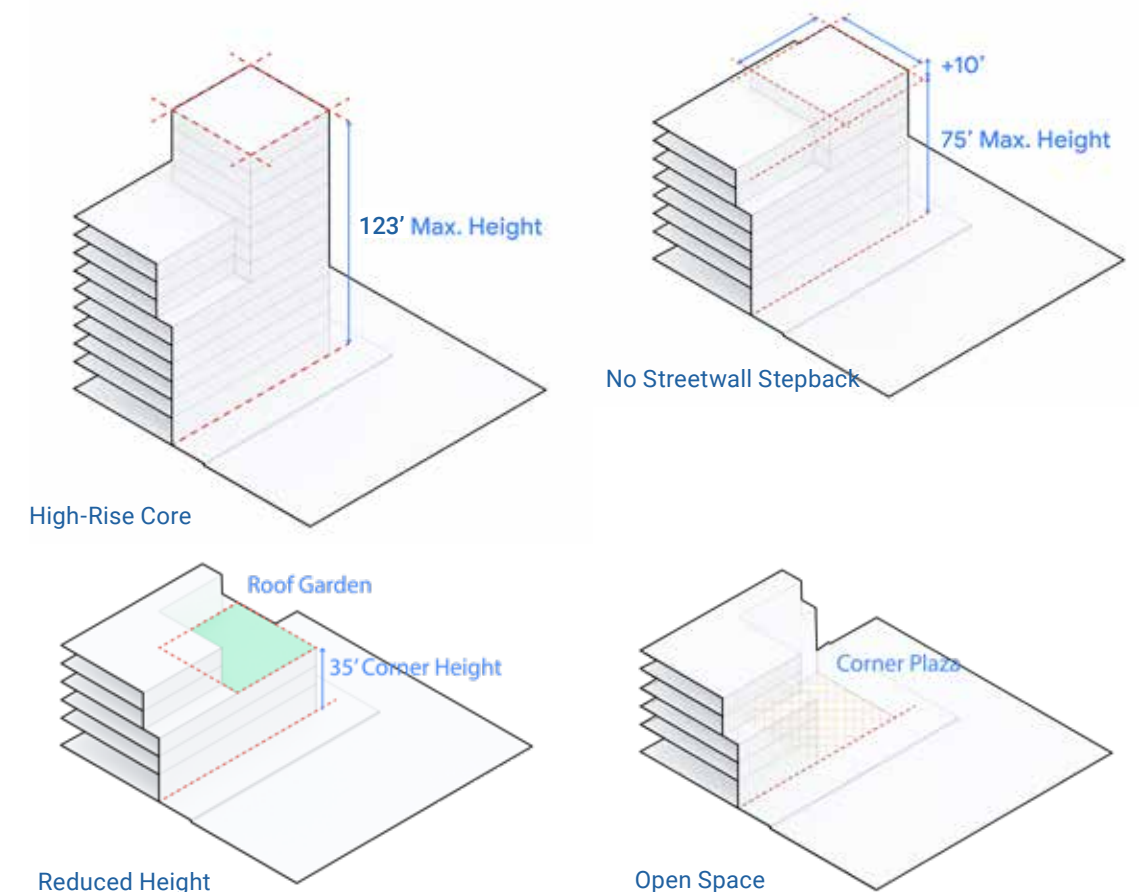

Figure 8.5.1 Examples of corner buildings and Key Corner architectural treatments

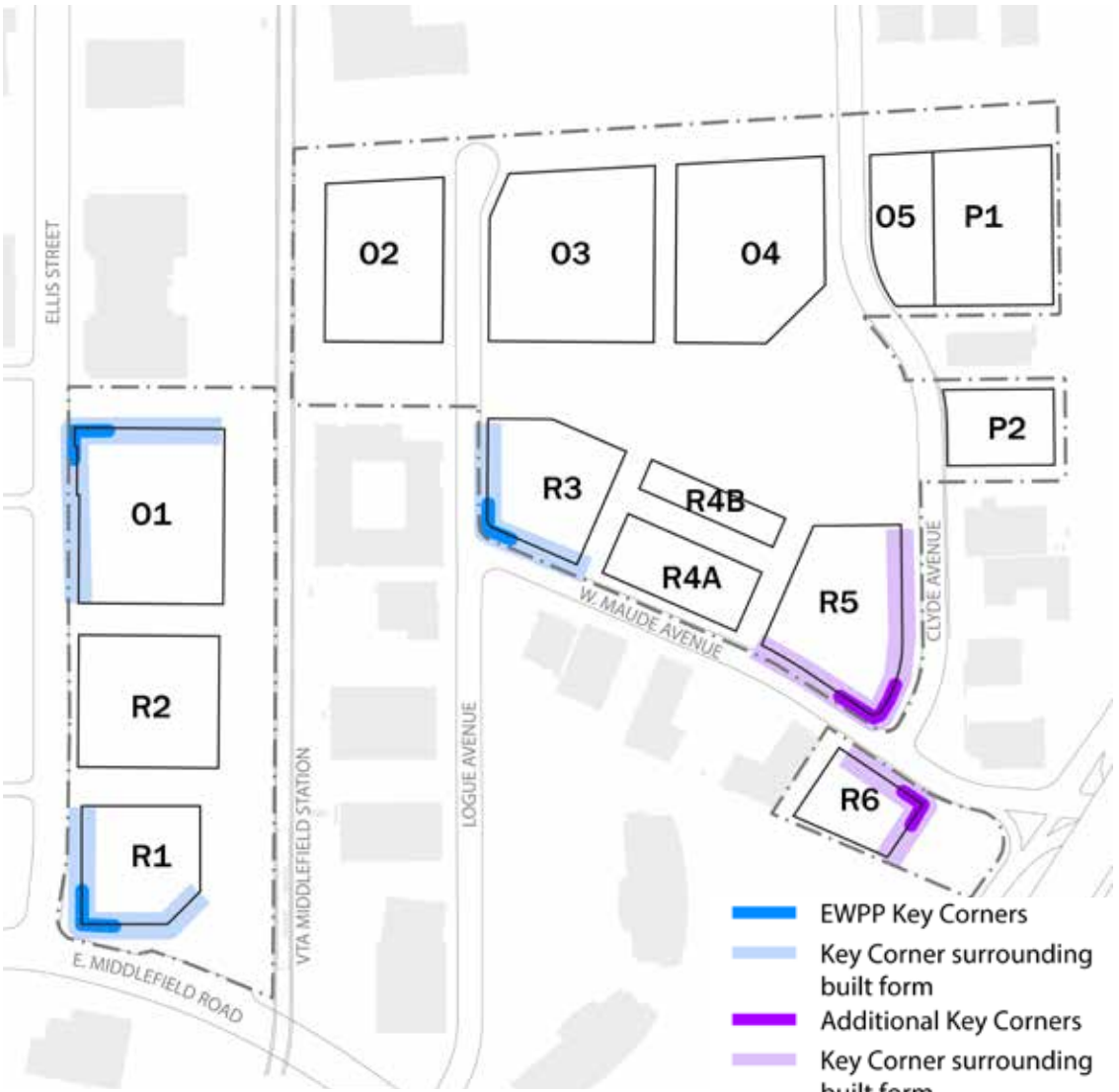

Figure 8.5.2 Key Corner design and corner buildings



Figure 8.5.3 Key Corner precedents



EWPP 4.1.1.1
 Key Corner Design. Facades located at 'Key Corners' should include special design and materials to provide variation and assist wayfinding and placemaking. When designing Key Corners, projects should consider views along nearby public streets. Key Corners may include prominent buildings, or recessed buildings to create plazas, public art, or prominent trees.

EWPP 4.1.1.2
 Corner Buildings. All projects should design corner buildings to emphasize an entry, shape a public space, and/or provide visual interest through taller or shorter building elements, special forms and materials, highly-visible entrances and/or landscape features.

BUILDINGS

EWPP 4.1.1.3

Building Relationship to Open Space. Building entrances should be oriented towards public open spaces. Upper floors facing open spaces should include special architectural treatments such as larger windows and/or upper floor stepbacks.

Building relationship to open space

The connected tree canopy and the variety of open spaces will be a defining experience for people in Middlefield Park, and as such, the connections between residential and office buildings to defining biophilic elements will drive the design of many buildings across this Master Plan. This is especially important since all development parcels within Middlefield Park address both a street and an open space so that the design of each building must balance the building frontage to both primary street and open space frontages.

Where residential frontages do address open space, active uses have been generally located towards open space and the tree canopy, and are expected to be supported further by active residential stoops and private open space and visual connectivity between office and open space. The variety of open spaces that the buildings will

address, and their varied responses to them, will greatly contribute to the vibrant character goals of the EWPP.

Residential frontages onto open space will utilize a combination of ground floor treatments. Where active uses can take advantage of spill-out outdoor seating, open space will be further activated. Furthermore, multiple design solutions exist to allow ground floor private open space to activate and keep open spaces safe, while still preserving privacy to ground floor units.

Office buildings will engage with open space using a range of suitable design typologies. Where possible, entry points and active edges will face onto open space. Some areas will use innovative landscape treatments or ground floor building elevation to preserve both visual connectivity to open space and building security.



Figure 8.5.4 Building relationship to open space

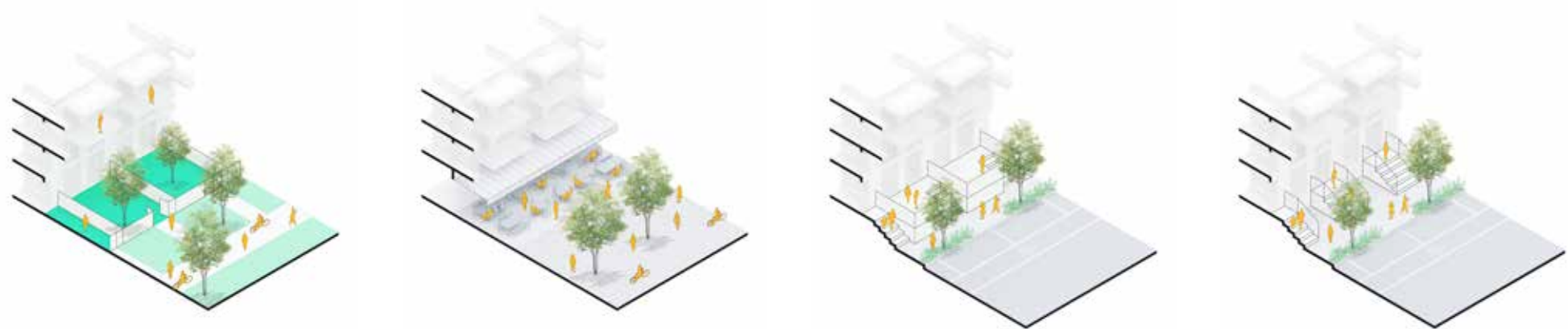

Figure 8.5.5 Examples of residential building ground floor relationships to open space

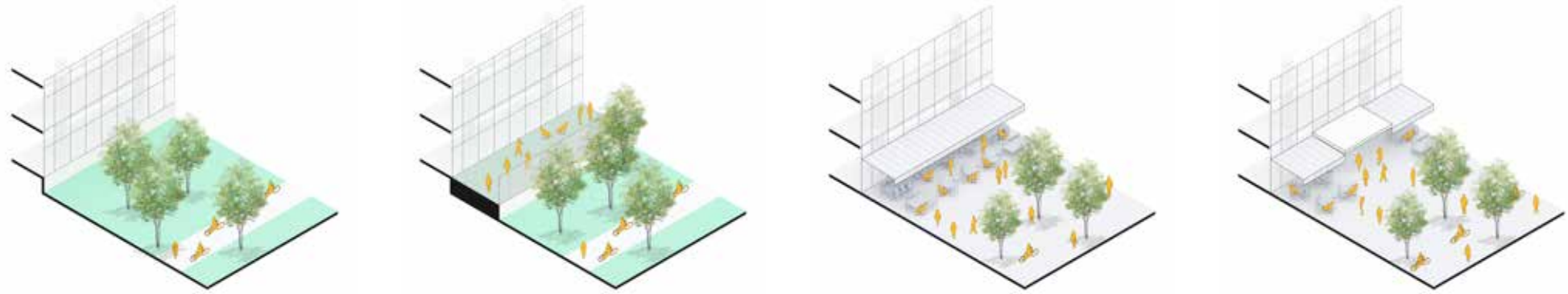

Figure 8.5.6 Examples of office building ground floor relationships to open space



Figure 8.5.7 Examples of building relationship to open space

BUILDINGS

EWPP 4.1.1.4

Differentiate Buildings. Building type and scale should vary within a block or project while maintaining a consistent street wall and frontage; for example, by mixing low-rise and mid-rise buildings. Multiple buildings in a single project or within a larger area should relate to each other, but provide differentiation through architecture, massing, materials, and site design features. Building heights should vary across East Whisman and individual project sites to create visual interest and to break up the scale of development.

Differentiate buildings

Floor area and height parameters have been intentionally applied in a way that each parcel within the Master Plan has the needed flexibility to create diverse and differentiated buildings. Through variations in both height and volume combined with massing breaks and changes in material treatment, component parts of each development will read as separate buildings and will reduce the bulk of each development. The distribution of floor area within the Master Plan tries to establish a mixture of building heights within each block, particularly in taller mixed use areas.



Figure 8.5.8 Examples of building differentiation

Building massing

The Middlefield Park Master Plan builds upon the objective of the EWPP to ensure a diverse and human-scale pedestrian experience. Breaks in building massing will be included along street wall frontages, in accordance with the intent of the EWPP design guidelines. Office buildings within Middlefield Park will be designed to have substantial massing breaks at intervals of 100 to 150 feet with no single building exceeding a maximum of 300 feet in length, unless additional massing relief is provided (to be reviewed as part of future permit entitlements). Residential/Mixed-Use buildings will be designed to have massing breaks 25 feet across approximately every 200 feet of building block face, at least 15 feet deep (see Figure 8.5.9). Use of additional vertical setbacks and massing breaks will be used to visually separate facades into smaller intervals. Appropriate massing breaks will be applied to building frontages facing parks and streets. Building breaks in frontage should be combined with changes in materiality, or combined with entry points where possible.

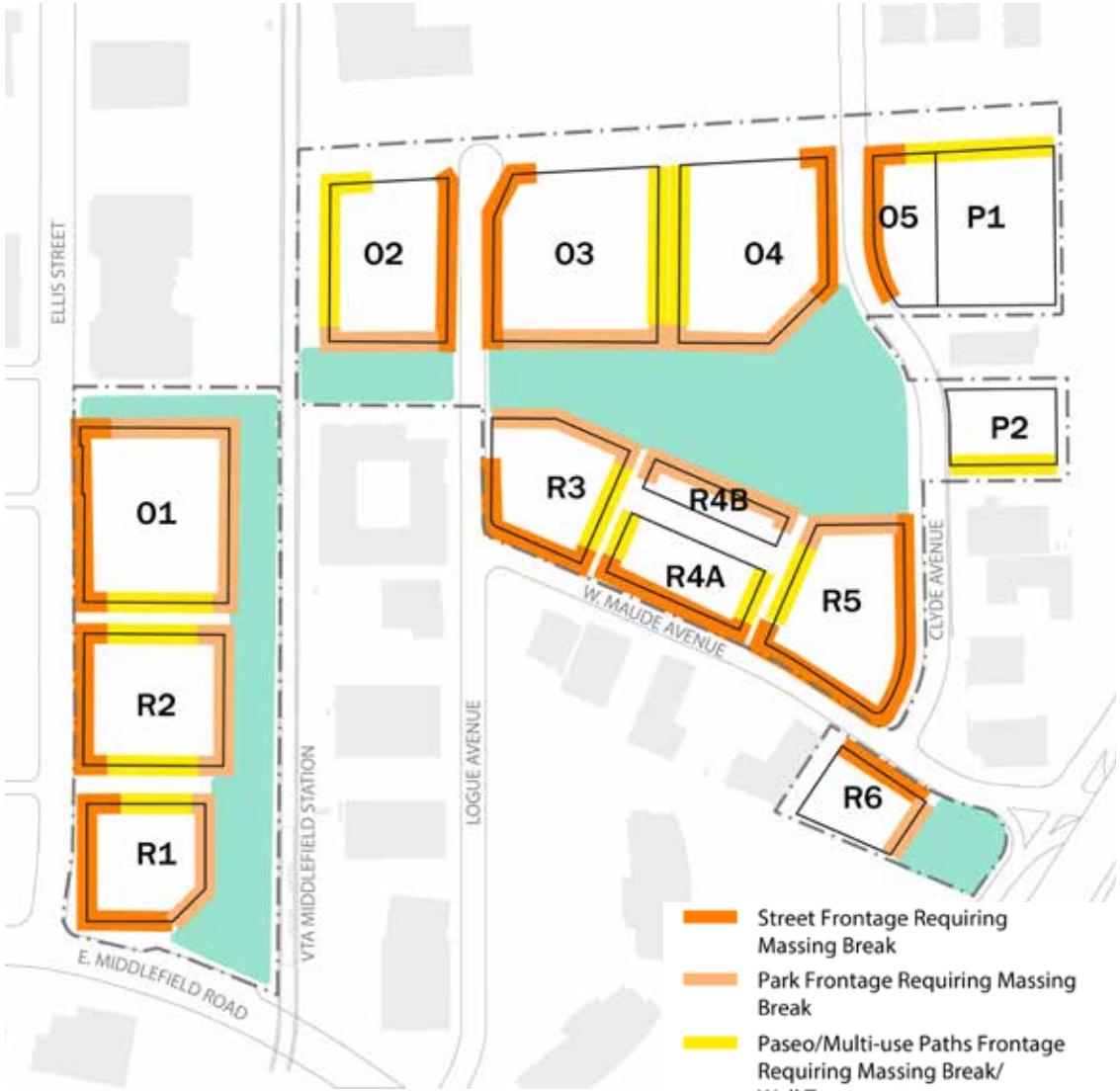

Figure 8.5.9 Building massing breaks

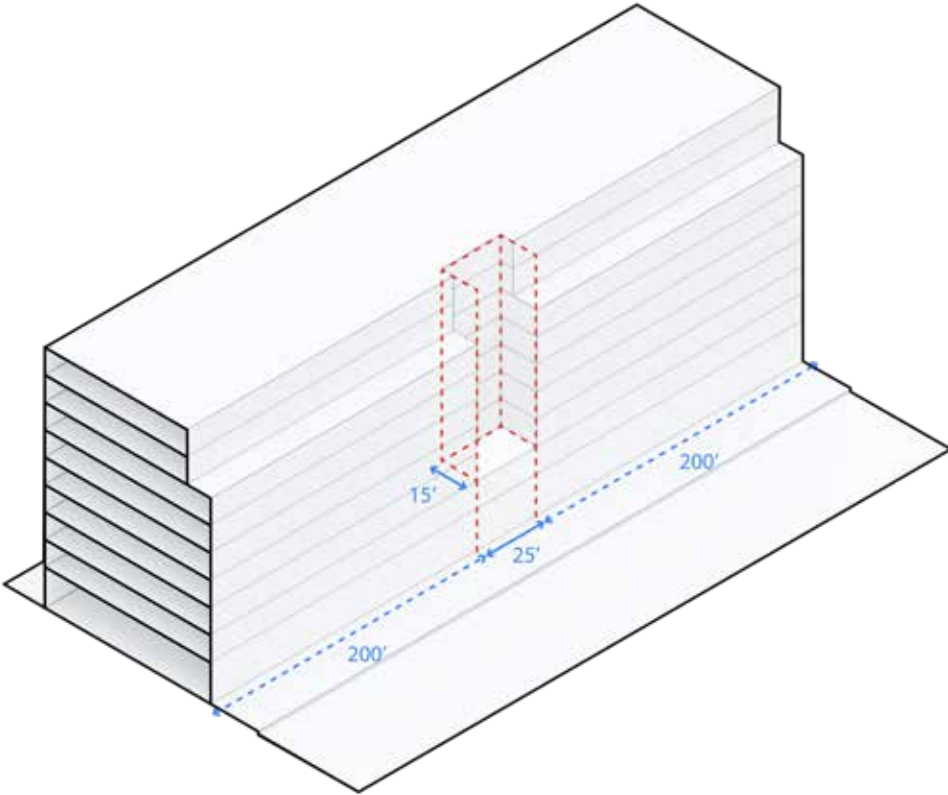

Figure 8.5.10 Example building massing breaks

EWPP 4.1.2.5 (for office/R&D buildings)

Facades should provide substantial massing breaks at intervals of 100 to 150 feet, emphasizing horizontally-oriented proportions. Office and R&D buildings should have a maximum length of 300 feet.

EWPP 4.1.3.8.a (for residential buildings)

Breaks at least 25 feet across should be provided approximately every 200 feet of block face. A “massing break” should be at least 15 feet deep (behind the front facade), and may include significant building articulation or a common space such as a forecourt, courtyard, paseo, or mews. Taller residential buildings should have fewer building façade increments than mid-rise residential buildings.

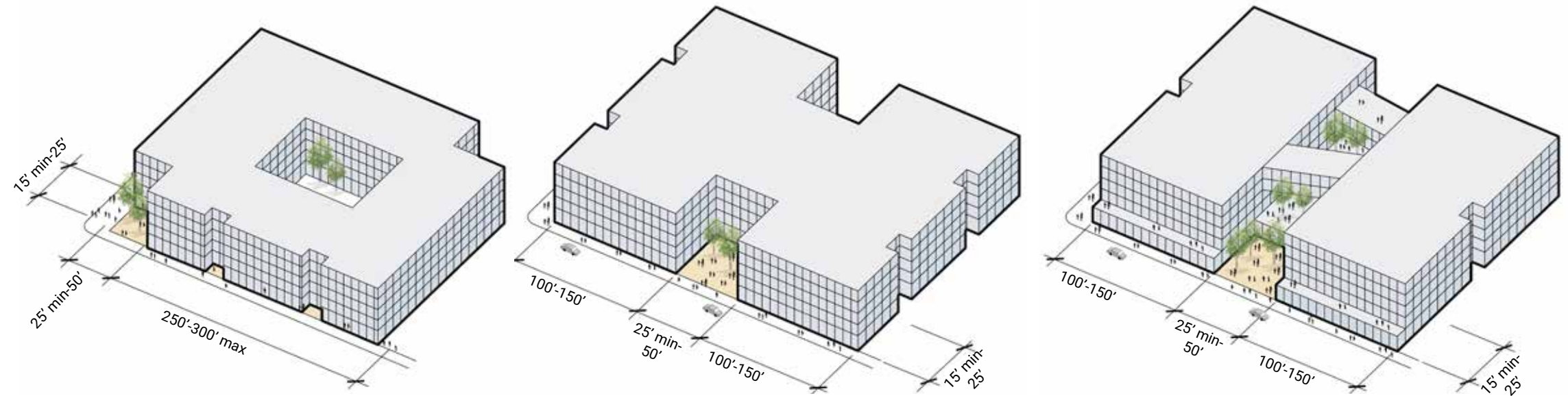

Figure 8.5.11 Examples of office/R&D buildings where street frontage lengths exceed 300 feet

EWPP 4.1.1.5

Building Massing. Building massing breaks should be used in each building to create a varied series of masses with a range of depths, widths, and heights. Massing changes or breaks may be used to ensure transitions between buildings and adjacent lots, improve visual interest, avoid large wall planes, accentuate neighborhood character, and help create more comfortable public and private spaces. Specific massing and articulation guidelines differ depending on building use as described below in the respective residential and employment sections.

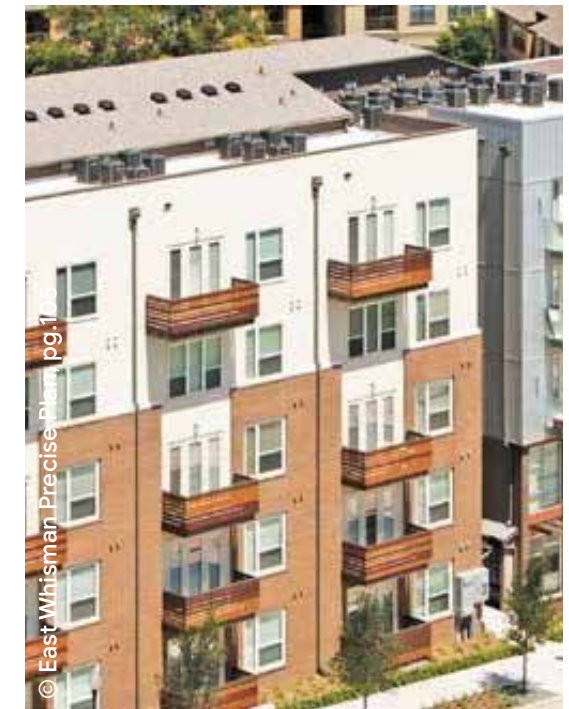

Figure 8.5.12 Examples of building massing breaks

8.6 Site planning flexibility

Building form and massing are shown as illustrative in this Master Plan in anticipation of specific building in implementation phases of the Project. Architects will deliver on the Master Plan objectives and also comply with the EWPP standards in the planning of individual or combined development sites.

In the architectural design of each building, the location of paseos and the modulation of building forms and heights will vary within the parameters of the land use and development framework established in Chapter 5 of this document. The designs will strive to find the best detailed solutions that connect pedestrians from surrounding streets through to transit and open space amenities while establishing diverse built forms that encloses shared private open areas.

Residential/mixed-use site planning options

Site planning of residential parcels fronting both Ellis Street and Maude Avenue can take on a variety of forms that maintain the maximum block sizes, provide site permeability to maintain access to open space, and create a legible division of public space and common usable open areas for residents as outlined in the EWPP.

Site planning will maintain the 400-foot maximum block dimension established by the EWPP. Additionally, future site planning will be guided by the Design Objectives, creating a diversity of built forms across sites to ensure delivery of the vibrant neighborhood envisioned by the Plan.

Office site planning options

The Master Plan summarizes performance criteria within the EWPP controls and guidelines for office buildings, largely related to their impact on the public realm. There remains a range of architectural solutions that conform to the controls, guidelines and intent while still leaving room for innovation and encouraging design excellence from architects on each site. This is illustrated below through a number of compliant options, all of which work within a maximum 400-foot block dimension in the Mixed-Use Character Area and 500-foot block dimension in Employment Character Area North.

BUILDINGS

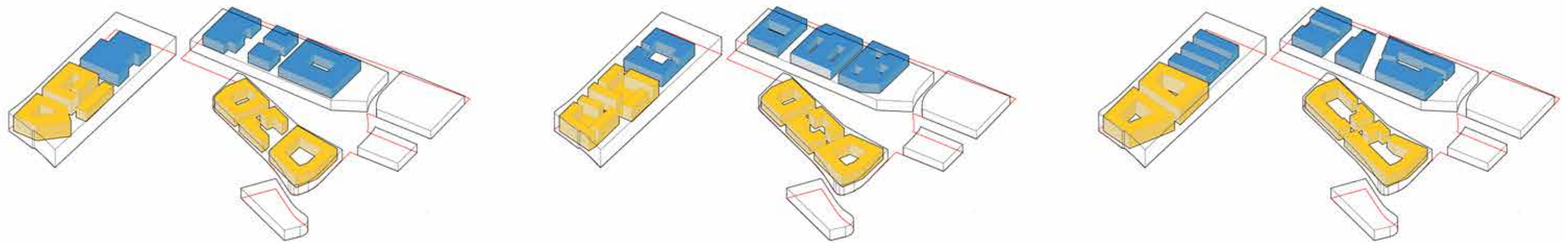

Figure 8.6.1 Example options of site planning for residential and office buildings

8.7 Garage strategy

To support the overall Master Plan parking strategy, two parking structures (P1 and P2) are planned along Clyde Avenue. The location of the structures allows easy access from both US 101 and SR 237, minimizing the number of vehicle trips entering the pedestrian-oriented core of the Project area. Mid-block crossings for pedestrians and bicyclists will enable safe and easy connections between the parking structures and office buildings.

These structures will provide off-site district parking for the five office buildings. A portion of required parking for expectant mothers, ADA, careshare and visitors is proposed to be provided at each of the buildings with the balance provided by the two district parking structures.

To support the Master Plan Vision for a connected community and pedestrian scale, the P1 garage will be lined with an office building, and the P2 garage may be designed with active ground floor uses. Enhanced facade treatments on facades visible from streets and layered landscaping, including trees, will further reduce visual impacts of the garages.

The P2 parking structure, along with the P1 structure, provides district parking for the office buildings proposed by the MPMP. Situated 27 feet from the curb, per the EWPP guidelines which requires a 15-foot setback from the sidewalk, and visually screened with street trees and on-site trees, the P2 parking structure will be minimally visible from Logue Avenue and the new neighborhood park. The ground floor may include space that is envisioned to support uses complementary to the neighborhood park while helping to activate the street.

To enhance the pedestrian realm and reduce the visual impact of district parking garages, facades visible from streets shall be visually attractive,

relate to adjacent development and mask the use of the structure as a parking garage. Design approaches could include: activating the street facing facade with active ground-floor uses; using design components and materials compatible with adjacent buildings; using screening materials such as louvers, vertical landscaping, photovoltaics, or other similar, visually attractive materials; replicating window patterns and other architectural elements to mask the parking use; and using landscaping and trees between the parking structure and adjacent street to shield the structure from view.

BUILDINGS

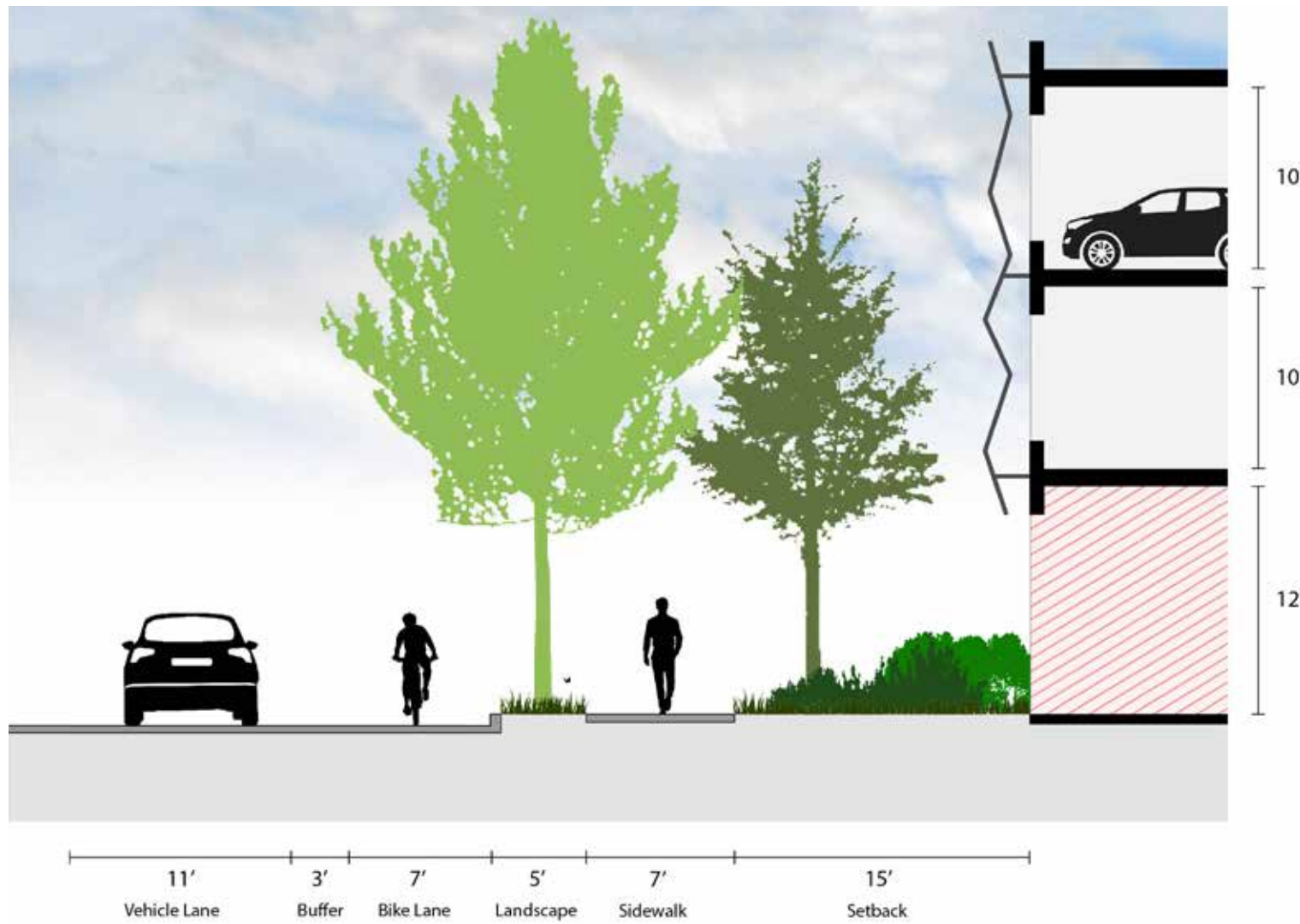

Figure 8.7.1 Proposed P2 garage section

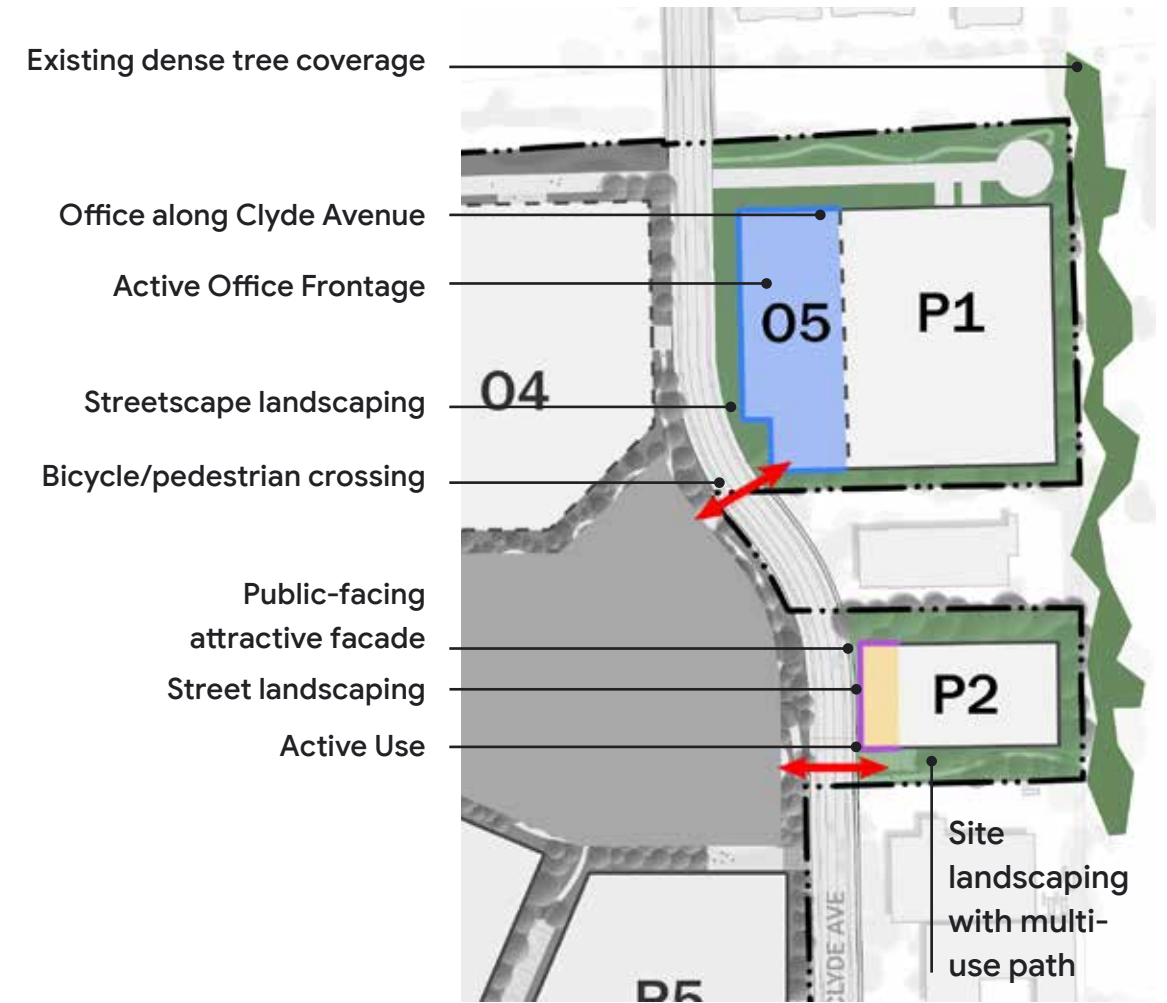

Figure 8.7.2 Garage, site frameworks

Garage strategy approach:

- Precise Plan Compliance
 - Massing & Building Guidelines
 - Ground Floor Use
 - 15-foot setback
- District Parking strategy with minimal on-site parking to encourage active mobility;
- Active ground floors to encourage pedestrian activity;
- Installation of rooftop photovoltaics equivalent to 50 percent of roof area, in accordance with CLUP height limitations;
- Enhanced facades where visible from public streets;
- Designed to provide adequate vehicular access and minimize queue lengths entering or exiting the garage.

P1 approach:

- Office Public Frontage (along Clyde Avenue).

P2 approach:

- Active ground floor use.

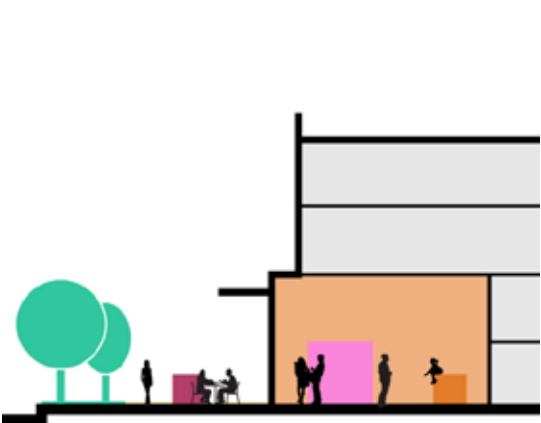

Active frontage

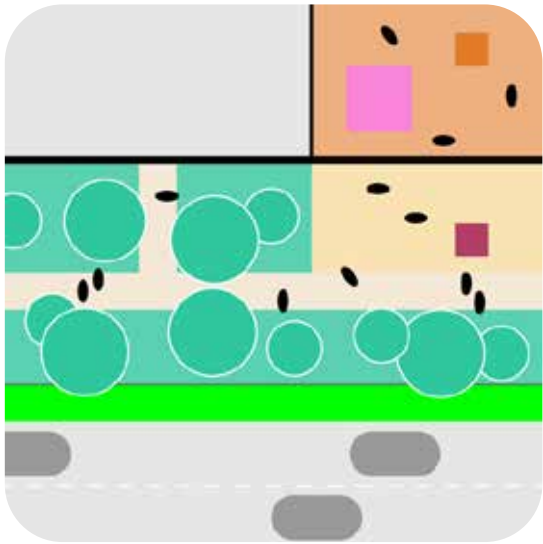

Limited street presence

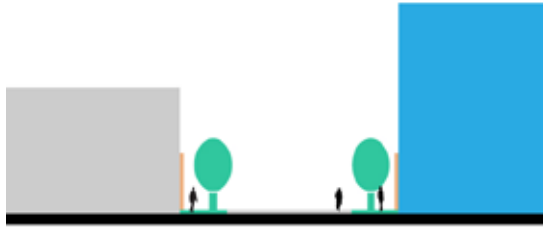

Integrated scale

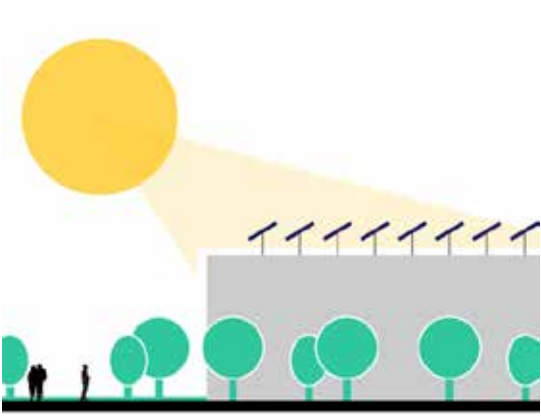

Sustainable

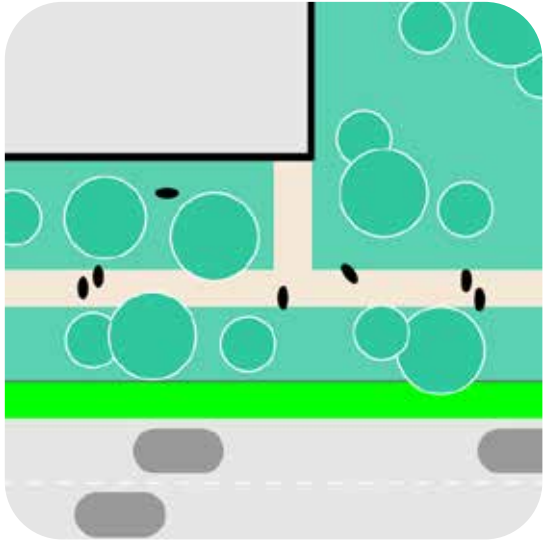

Landscape buffer

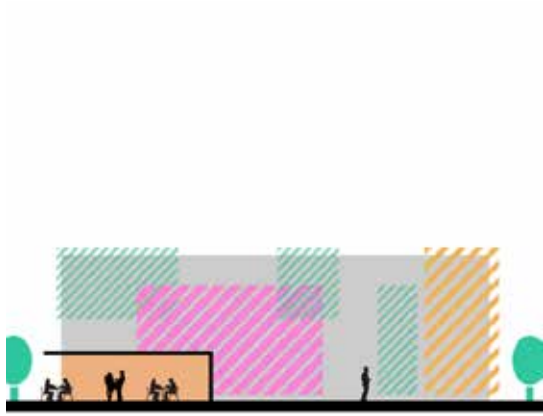

Visual interest, attractive screening/materiality

Figure 8.7.3 Garage structure goals

BUILDINGS

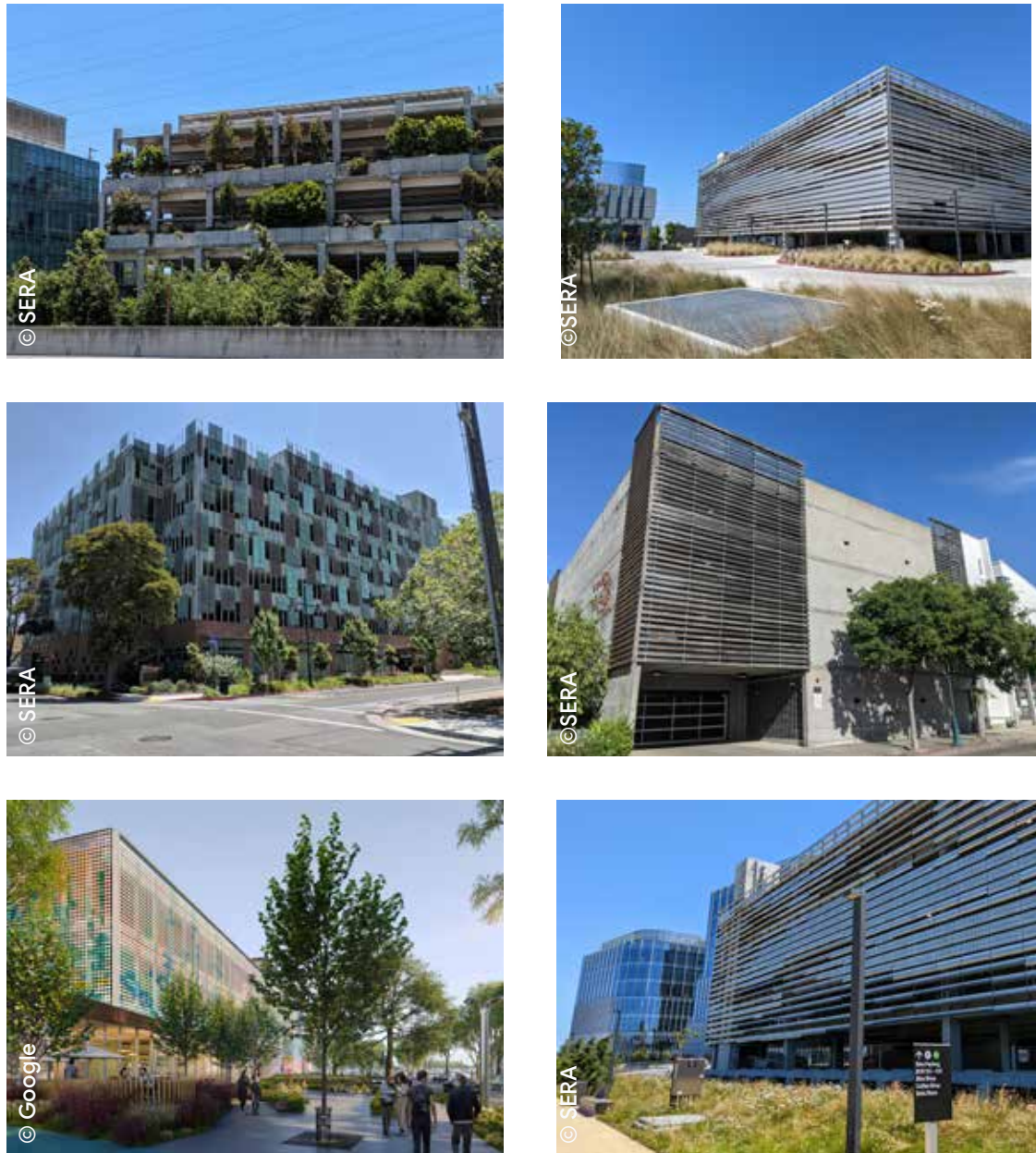

Figure 8.7.4 Garage facade treatment precedents



Figure 8.7.5 District garage parking strategy

9. UTILITY INFRASTRUCTURE

The vision of the Middlefield Park Master Plan is to enhance natural areas, connect communities, and create resilient infrastructure systems that support the transition of the East Whisman Precise Plan Area into a sustainable district.

9.1 Infrastructure at a district scale

The proposed sustainable infrastructure strategy of the MPMP aims to meet or exceed the Precise Plan, Mountain View Reach Code, and General Plan goals to promote green building performance for water and energy systems, increase green stormwater infrastructure, and prioritize the use of recycled water.

Google will test options to enhance the performance of Middlefield Park, with a focus on creating a sustainable framework that is underpinned by district systems. Various options for the inclusion of district systems will be analyzed that target low carbon and resource efficient outcomes. District systems have the potential to enhance the performance of the infrastructure plan. The systems can have a significant impact given that they sit at the interface of the horizontal infrastructure layer, the environment, and the built form.

Key objectives are to conserve natural resources and to optimize energy and water performance. The potential integration of a district systems strategy will complement the traditional building and infrastructure systems seeking to increase resilience within Middlefield Park. Furthermore, district-scale utilities would allow the Project to optimize performance as well as reduce strain on existing utility systems, delivering strong outcomes across the key resources of thermal energy, power, and water.

CITY OF MOUNTAIN VIEW SUSTAINABILITY GOALS



Figure 9.1.1 Alignment with City of Mountain View Sustainability Goals

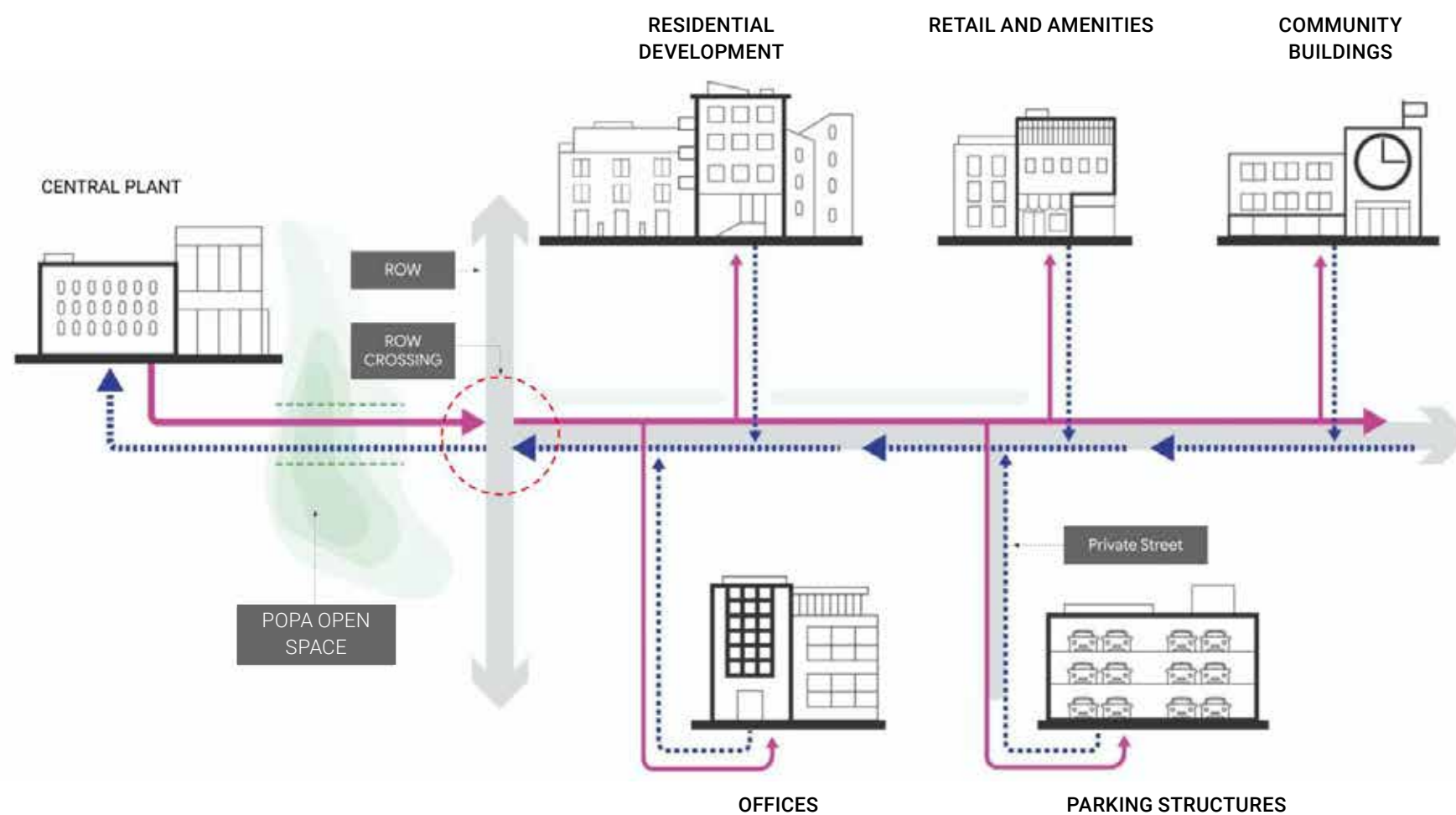

Figure 9.1.2 Overview of District Systems in a mixed-use development

Sustainable infrastructure

In alignment with the Precise Plan and the City’s sustainability goals, the Project is pursuing high-performance results in terms of carbon reduction through on-site and off-site measures, as well as potable water use reduction.

District systems, through the consolidation of systems, can deliver resource efficiency, reduced energy use and carbon emissions, and reduced potable water consumption. Google is investigating how to enhance the performance of the Project, by creating a sustainability ecosystem focused on district systems. By connecting resources across the Master Plan Area, the district would be more sustainable and resilient. Centralized infrastructure could also be upgraded more easily over time, allowing the Plan to continue to progress toward a decarbonized, closed-resource-loop district. The integration of multiple systems in a single location could also create significant operational

benefits for users and reduce the demands placed on the City systems.

Under the district scenario, a central utility plant (CUP) would provide all-electric centralized thermal heating and cooling with high efficiency equipment for offices and residential/mixed-uses. In response to the City’s desire to use recycled water and address the water reduction program, Buildings will connect to the City-wide recycled water network if feasible, and/or develop a district water reuse facility on site to achieve the desired outcomes.

Connectivity

Implementation of the district systems requires connectivity of multiple structures and programmatic uses across distinct property boundaries including public rights of way (ROWs). The mixed use character of the proposed Master plan provides a strong platform to turn the diversity of needs, both in terms of time of use and capacity,

INFRASTRUCTURE

into an optimized solution through the district systems approach. The unique consolidation offered at the district scale unlocks significant environmental benefits not otherwise achievable at the building scale. The benefits of connecting various land use types is to capitalize on the varying resource demands throughout the Project, an outcome that can only be effectively pursued at scale. A joint trench connecting all private utilities throughout the office, residential, and retail areas at Middlefield Park would allow resources to be delivered in an efficient way and minimize space requirements. See Figure 9.1.3 for an example of a potential route for district systems utilities.

The District Systems corridor illustrated on Figure 9.1.3 minimizes public ROW crossings and encroachments. It would have the potential to include thermal hydronics, geothermal distribution, electrical, private telecommunications, sanitary sewer, and recycled water. Utility crossings through the public ROW would be closely coordinated with the City and utility providers. Additionally, close coordination with VTA to cross its ROW with utilities would also be required. Middlefield Park will be served by the City's existing water and storm drain systems.

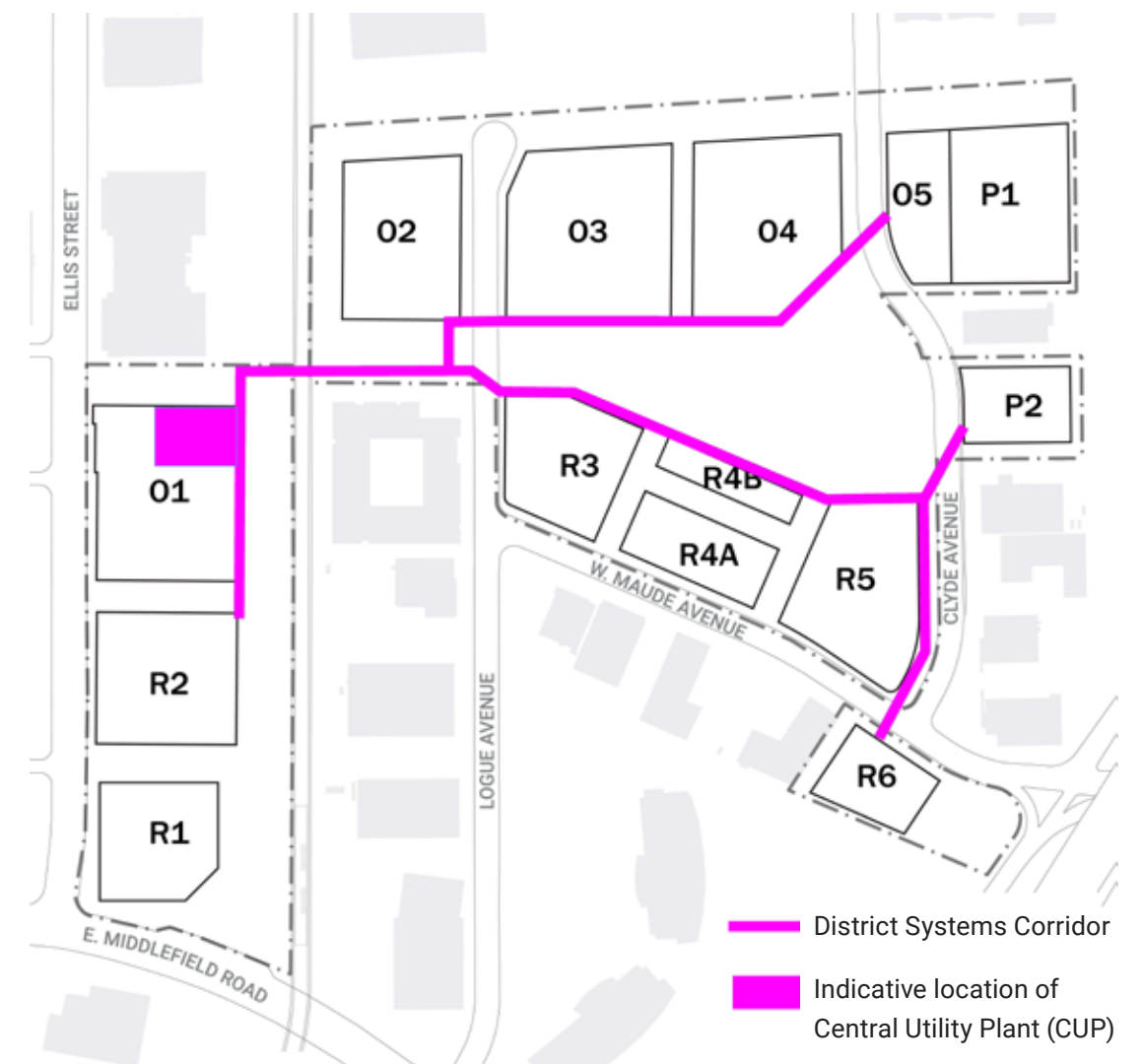

Figure 9.1.3 Potential district system corridor and CUP location. All locations are subject to adjustment based on land disposition.



Figure 9.3.1 Interior view of the East Carolina University Central Utility Plant

9.2 Thermal energy

Goals

Driven by the growth envisioned at Middlefield Park, Google's approach will be to investigate the benefits of incorporating highly efficient heating and cooling technologies while also fostering improved business continuity and resilience to the entire precinct compared to a more traditional building-by-building approach. The design solutions analyzed will aim to achieve substantial energy savings through equipment consolidation, streamlined operations, removal of natural gas as a fuel source, and site-wide heat recovery opportunities. Within the built form, the district systems approach would aim to be adaptive so as to enable new technologies and a variety of efficient, multi-functional phasing plans.

Strategies

The mechanical systems will be designed in accordance with the most recent California and City of Mountain View codes, ASHRAE standards, and the adopted REACH code. Additionally, in order to meet the intent of LEED BD+C and Green Point Rating, the Project will assess the opportunity to include the following strategies:

- Centralized heat recovery chillers for primary heating and cooling;
- Centralized air source heat pumps for supplemental heating and cooling;
- Centralized water cooled chillers and cooling towers for supplemental cooling;
- Rooftop solar thermal panels;
- Centralized thermal energy storage tanks;
- Ground source deployment; including options for ground loops/energy piles coupled with heat recovery chillers and heat pumps.

9.3 Power

Goals

Fully aligned with Mountain View's drive to switch away from natural gas for commercial and residential uses, the Project will be all-electric. The Project is committed to utilizing 100% carbon-free renewable energy for electrical service for all new buildings, regardless of the service provider. This is an ambition for new buildings and allows for innovative technologies to be implemented towards a carbon-free future. The increasing prevalence and impact of natural disasters due to climate change creates an imperative for resilient design. The implementation of energy demand management strategies with renewables will reduce peak loads, and a grid-tied microgrid with solar and storage could be used to provide additional resilience.

Strategies

The electrical systems will be designed in accordance with the latest California and City of Mountain View codes, ASHRAE standards. Additionally, in order to meet the intent of LEED BD+C and Green Point Rating or equivalent, the Project will assess the opportunity to include the following strategies:

- LED lighting with occupancy sensors and daylight automation;
- Plug load management and demand response;
- Photovoltaic panels;
- Electric vehicle charging-ready infrastructure;
- Battery storage for loading shifting and carbon and demand cost reduction;
- Grid-tied microgrid;
- Off-site renewable energy generation.

9.4 Water



Figure 9.3.2 Barangaroo Plantroom (Sydney, Australia)

Goals

The Project holds conservation and preservation of local and regional water resources as a key priority. In alignment with the sustainability goals of the City of Mountain View and the East Whisman Precise Plan, the Project endeavors to meet stringent green building and water conservation practices. The Project strives to diversify its use of water resources by maximizing the use of recycled water through collaborating with the City to achieve the best system that meets shared objectives.

Strategies

In order to achieve Middlefield Park’s water goals, the Project will follow a sustainable design approach that employs efficient water management strategies and optimized solutions for water reuse. The water systems will be designed in accordance with the latest California and City of Mountain View codes. Additionally, in order to meet or exceed the intent of LEED BD+C and Green Point Rating or equivalent, the Project will assess the opportunity to include the following strategies:

- Water-efficient fixtures;
- Water-efficient irrigation systems;
- Dual-plumbed buildings;
- Planting native, drought-tolerant plants compatible with recycled water;
- Recycled water use for mechanical operations, irrigation, and toilet flushing;
- On-site water reuse facility;
- Leak detection & monitoring.

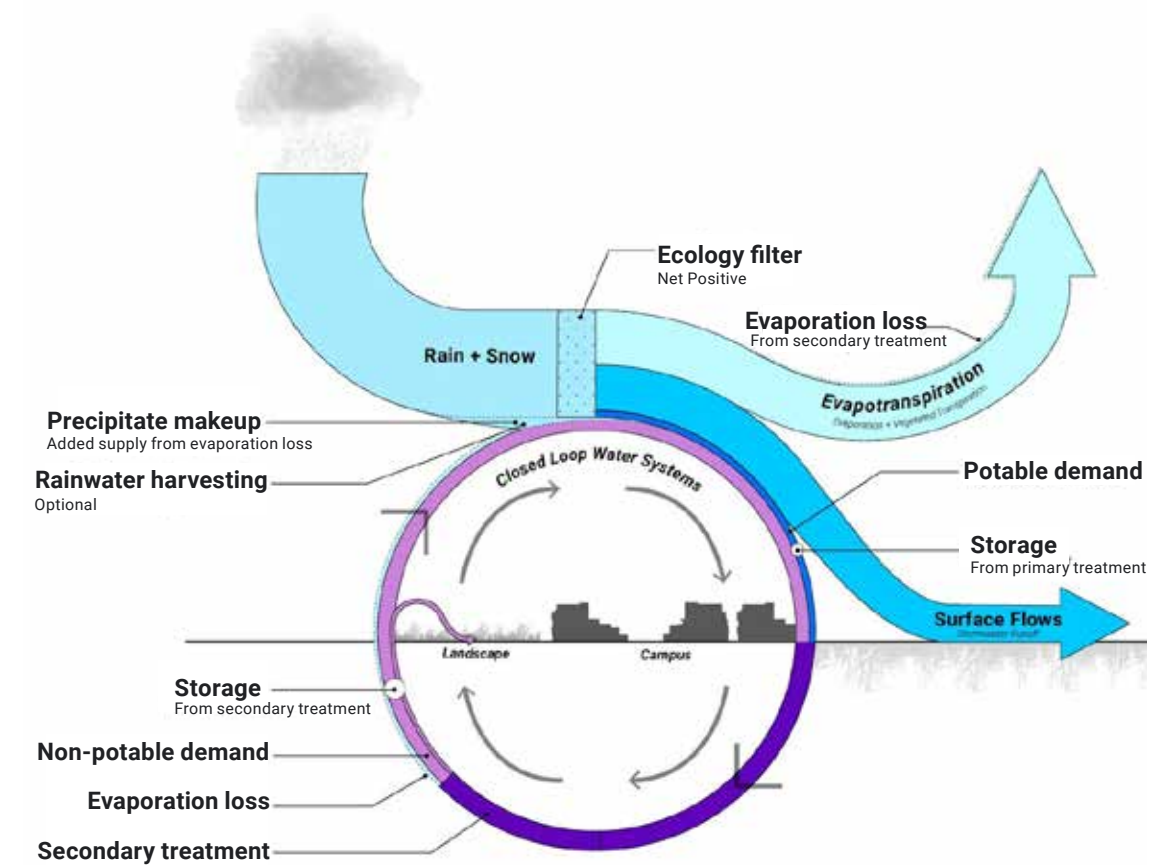

Figure 9.4.1 Water balance concept

© Sherwood Design Engineers

10. PROJECT BENEFITS

The redevelopment of Middlefield Park will be implemented over several years with phased planning entitlements and construction, an extensive Community Benefits program, and valuable fiscal contributions. As a result, East Whisman will be the focus of both physical and social infrastructure investments for years to come.

10.1 Community benefits

Community benefits

The Middlefield Park Master Plan offers many new amenities and benefits to the larger neighborhood and the City of Mountain View, and represents a great investment in East Whisman. Upgraded streets and bike lanes, new accessible open space, market and restaurant areas, and multiple funding contributions are all included in the proposal. Google is committed to being a helpful neighbor in Mountain View and looks forward to delivering community benefits, commensurate with Google's development proposals in this Master Plan, to help achieve the EWPP's objectives and vision. See Development Agreement for details.

10.2 Fiscal impact

Economic and Planning Systems has conducted a concept level analysis of the property tax revenue impacts of Google's proposed plan for Middlefield Park. The analysis estimates an increased assessed value of \$2.3 billion associated with the proposal and identifies a \$4.7 million net increase in annual property tax-related revenues accruing to the City's General Fund at build out. It also indicates the net new property tax that would commensurately accrue to other taxing districts including Mountain View Whisman School District, Mountain View Los Altos Union High School District and Santa Clara County.

Overall fiscal impact findings

The analysis focuses on property tax-related revenues, though it is recognized that a more detailed analysis would consider additional revenues items (e.g., sales and use taxes), as well as public service expenditures.

The key fiscal impacts of the proposal are:

- Estimated to have a development value/ assessed value of ±\$2.7 billion, resulting in a net increase in assessed value of ±\$2.4 billion once existing assessed value is netted out;

- Estimated to generate ±\$4.7 million annually in property tax related revenues to the City's General Fund at Project build-out in 2020 dollars. This includes ±\$3.8 million annually in property tax revenues and ±\$875,000 in property tax, in lieu of vehicle license fees revenues;
- Other taxing entities will receive substantial annual property tax revenues, including ±\$3.8 million to the Mountain View Whisman School District, ±\$1.7 million to the Mountain View Los Altos Union High School District, and ±\$3.8 million to Santa Clara County.



Middlefield Park Master Plan

