

CITY OF MOUNTAIN VIEW  
RESOLUTION NO.  
SERIES 2022

A RESOLUTION OF THE CITY COUNCIL OF THE CITY OF MOUNTAIN VIEW  
AMENDING THE DOWNTOWN P(19) PRECISE PLAN TO UPDATE DESIGN STANDARDS  
AND GUIDELINES IN AREAS A, G, AND H AND DISALLOW ADMINISTRATIVE OFFICE USE  
IN GROUND FLOORS OF CASTRO STREET AND SIDE STREETS OF AREA H

WHEREAS, the City Council initiated an amendment of the Downtown P(19) Precise Plan to provide clearer direction to applicants regarding City expectations for historic design principles and interest, including use of traditional materials and composition; to better ensure projects are consistent with community vision with objective design standards; encourage active uses that promote economic diversification and preserve the look and feel of downtown; and strengthen the downtown pedestrian-level experience; and

WHEREAS, procedures set forth in Chapter 36 Article XVI, Division 11 of the Mountain View City Code, whereby the City can amend a Precise Plan, have been executed; and

WHEREAS, Chapter 36 of the City Code requires the City's Environmental Planning Commission and the City Council each hold a duly noticed public hearing before a Precise Plan is amended; and

WHEREAS, the Environmental Planning Commission held a duly noticed public hearing on September 21, 2022 and recommended the City Council approve the Downtown P(19) Precise Plan Amendments; and

WHEREAS, the City Council held a public hearing on December 6, 2022 and received and considered all information and materials presented at said hearing regarding the Downtown P(19) Precise Plan Amendments, including the recommendation from the Environmental Planning Commission, City Council report, project materials, testimony, and written materials submitted;

NOW, THEREFORE, BE IT RESOLVED by the City Council of the City of Mountain View that the City Council hereby makes the findings for amendment of a Precise Plan, pursuant to Section 36.50.95 of the Mountain View City Code:

- a. The proposed Precise Plan is consistent with the General Plan because it sets forward objective design standards for human-scaled building details and encourages ground-level pedestrian activation consistent with General Plan Goal LUD-7 (a vibrant downtown that serves as the center for Mountain View social and civic life) and policies thereunder;

b. The properties covered by the proposed Precise Plan Amendments are within the Planned Community (P) Zoning District as the Amendments are to the text of the existing Precise Plan;

c. The proposed Precise Plan would not be detrimental to the public interest, health, safety, convenience, or welfare of the community because no new significant impacts would occur, and no previously examined significant effects would be substantially more severe than previously disclosed by the approval of the Precise Plan and the subsequent amendments to date;

d. The proposed Precise Plan promotes the development of desirable character, harmonious with existing and proposed development in the surrounding area, because the amendments set objective standards for new buildings and building modifications that are compatible with the historic character of Areas A, G, and H; promote pedestrian activity by encouraging retail and similar activating uses; and help achieve General Plan Policy LUD 7.3 (Human-scaled building details);

e. The site has special conditions of size, shape, land ownership, existing development, or development opportunities that can only be addressed by approval of the proposed Precise Plan Amendments because the sites are regulated by the Downtown P(19) Precise Plan; and

f. The approval of the proposed Precise Plan Amendments is in compliance with the provisions of the California Environmental Quality Act (CEQA), because an addendum was completed pursuant to CEQA Guidelines Section 15162 and Section 15164, finding that no new significant impacts would occur, and no previously examined significant effects would be substantially more severe than disclosed in the adopted 1999 City of Mountain View Downtown Precise Plan (Precise Plan) Initial Study/Negative Declaration (IS/ND), adopted 2004 City of Mountain View Downtown Precise Plan IS/ND, and certified 2012 Mountain View 2030 General Plan Environmental Impact Report (General Plan EIR).

BE IT FURTHER RESOLVED by the City Council of the City of Mountain View that the Downtown P(19) Precise Plan Amendments, as more specifically shown in Exhibit A, attached hereto and incorporated herein by reference, is hereby approved.

BE IT FURTHER RESOLVED by the City Council of the City of Mountain View that the standards and guidelines adopted pursuant to this Resolution shall not apply to formal

applications for zoning permits received prior to September 15, 2022, unless the applicant agrees to the applicability of amendments in their entirety.

-----

EM/4/RESO  
808-09-21-22r

Exhibit: A. Precise Plan Amendments

## AREA A. EVELYN AVENUE BLOCK

### A. DEVELOPMENT STRATEGY

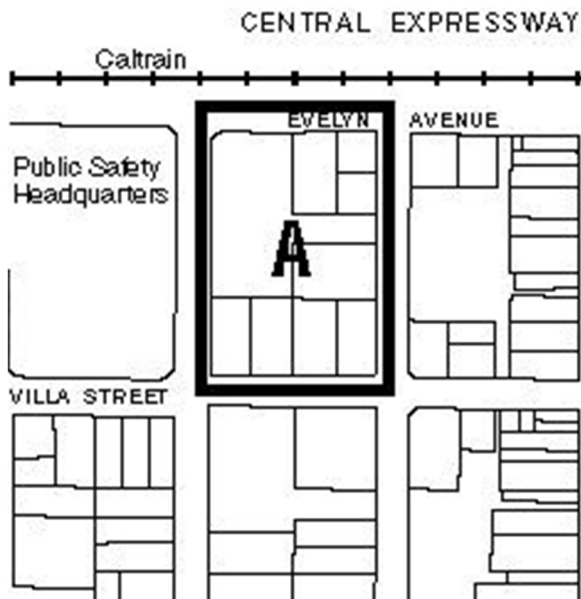

Fig. A.1: Area A

The Evelyn Avenue block is a highly visible edge of the Downtown and is envisioned as having a mix of commercial and residential uses. Retail businesses, restaurants, and active uses would be focused on Villa Street, which is one of the principal entrances to downtown. On Villa Street, ground-level businesses should be primarily retail stores and restaurants.

The historic buildings in Area A contribute to the character of downtown. New developments on Villa Street should be a visual extension of Castro Street storefronts, should support the transition of building massing and activities from the commercial district and be sensitive to the existing buildings in the area.

Interesting building facade materials and varied roof forms are encouraged to provide visual interest. Residential projects must be designed to minimize the noise and ground vibration impacts from Central Expressway and the Caltrain line.

Attention must be given to upper-level treatment and detailing that is recognizable and distinctive from a distance (colorful canopies, fenestration, interesting roof forms, facade ornamentation, etc.).

Open space within the downtown area will have an urban character consistent with the Downtown and should act as an attractive buffer between uses and should be used to effectively articulate building forms, promote access to light and fresh air, and maintain privacy for downtown residents. It should also provide amenities to residents in residential developments and function as a visual amenity for non-residential uses.

Parking requirements for Area A are described in Section II.C, Parking Standards and Policies. To maintain an attractive and lively pedestrian environment, parking should be below-grade or in parking structures. Curb cuts should be minimized to promote traffic and pedestrian safety and create cohesive landscaping and building facades.

### B. USES

#### 1. Permitted and Provisional Uses

Table A.1: List of Permitted and Provisional uses in Area A.

Use	Fronting Villa Street		Other locations
	Ground Level	Upper Levels	
Retail, not including drive-up or drive-in services	P	P	PUP
Art galleries	P	P	PUP
Personal services	P	P	PUP
Restaurants, including serving of alcoholic beverages clearly ancillary to food service; not including drive-up or drive-in services	PUP	PUP	PUP

Business services	P	P	PUP
Childcare centers			PUP
Hotels			PUP
Theatre, entertainment and indoor recreational uses	PUP	PUP	PUP
Offices, not including administrative offices	P	P	PUP
Administrative offices	PUP	P	PUP
Residential, up to 50 units per acre		P	P
Efficiency studios			PUP
Senior housing at up to 60 units per acre			PUP
Surface parking and parking structures that meet the standards in Section II.C	PUP	PUP	PUP
Other businesses or service establishments which are determined by Zoning Administrator to be of a similar character as listed in this table	PUP	PUP	PUP

P – Permitted Use; PUP – Provisional Use Permit

**2. Prohibited Uses along Villa Street and the Remainder of the Block**

- a. Bars and nightclubs serving alcoholic beverages not ancillary to food service.

**C. DEVELOPMENT REQUIREMENTS**

For preservation and restoration of Historic Resources, refer to the Historic Ordinance for development requirements and standards.

Table A.2: Development requirements in Area A.

Development Requirement	Parcels Fronting Villa Street	Other parcels
Maximum Height	50 feet	
Maximum FAR	1.85	
Front and Side Yard Setbacks	5 feet Zoning Administrator may allow a deviation if it improves the quality of the project and enhances the commercial storefront character of the downtown district.	5 feet
Rear Yard Setback (Buildings)	15 feet	
Rear Yard Setback (Below and at-grade parking)	5 feet	
Setback Encroachments	Porches, steps, landings, or terraces may encroach into these areas as long as more than 50% of the setback area is reserved for landscaping.	
Trees in Setbacks	Side and rear setbacks shall have trees that are 24-inch box size at a minimum spacing of 30 feet on center.	
Upper Floor Stepbacks	10-foot stepback above 2 stories from ground level. Encroachment in the stepback is allowed for block corner features for a maximum width of 20 feet.	No minimum

Minimum Open Space (Projects containing Residential)	30 percent of lot area
Minimum Open Space (Non-Residential Projects)	20 percent of lot area. The Zoning Administrator may allow a reduction if it improves the quality of the project and enhances the commercial storefront character of the downtown district.
Minimum ground floor height (Non-residential)	10 feet (finished floor to ceiling clear height)
Finished ground floor elevation (residential units)	Within 5 feet above sidewalk level ( <i>see Fig. A.4</i> )

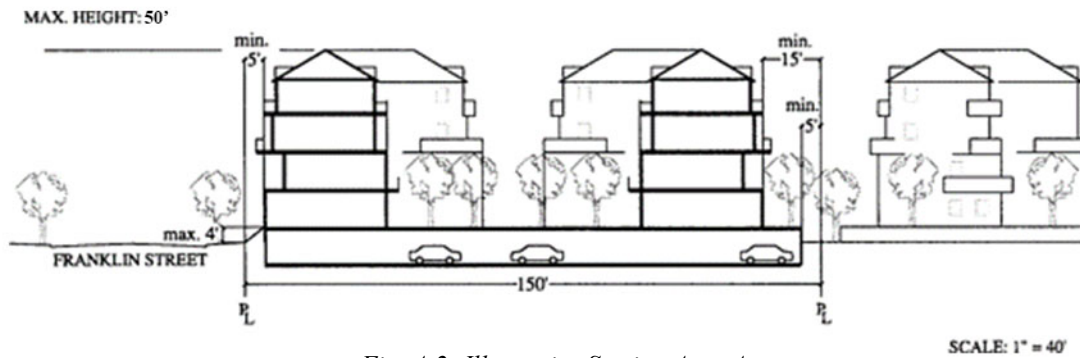

Fig. A.2: Illustrative Section Area A

## D. DESIGN STANDARDS AND GUIDELINES

### 1. Development Massing

#### Standards

- S1. For developments adjacent to historic buildings, the building massing shall step down to be a maximum of 10 feet taller than the height of the adjacent historic building for a minimum of 10 feet from it (*see Fig. A.3*).
- S2. A character change shall be provided at least every 75 feet (*see Fig. A.3*). Character changes include at least two of the following: changes to primary colors, changes to primary materials, and changes to primary wall planes. Projects may elect to provide a massing break in lieu of or in addition to a character change. Massing breaks shall be minimum four feet deep and 10 feet wide.

#### Guidelines

- G1. Massing breaks, stepbacks and/or step-downs should be provided to create transition to existing surrounding development (*see Fig. A.3*).
- G2. Special corner features should be incorporated at corner parcels. These may include but are not limited to display windows, corner roof features, taller massing and change in materials (*see Fig. A.3*). See *Table A.2* for allowed exceptions for corner features.

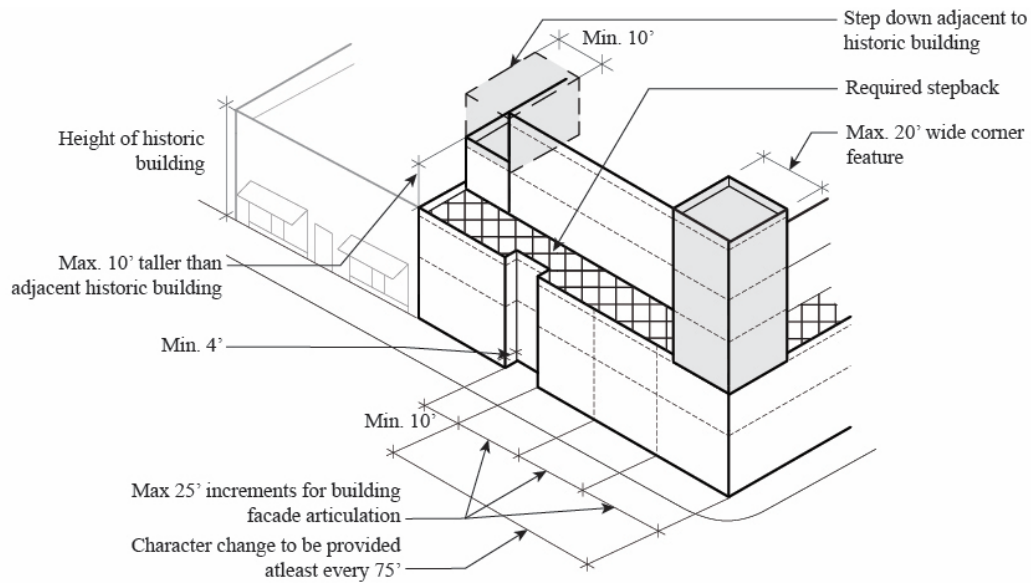

Fig. A.3: Example of stepdown adjacent to historic buildings and taller massing at the block corner.

## 2. Ground Level Treatment and Facade Articulation

### Standards

S1. Street- and public open space-facing building facades shall be articulated in increments of up to 25 feet width using architectural and structural elements such as columns, fenestration patterns, entry alcoves, or changes in facade planes and materials (see Fig. A.3).

### Guidelines

- G1. Commercial development should meet ground-level treatment guidelines outlined in the Historic Retail District.
- G2. Pedestrian-level articulation should include storefront detailing, facade ornamentation, special materials, flower boxes, and other improvements to reinforce the pedestrian nature.

## 3. Entrances

### Standards

S1. Primary pedestrian access to street-facing ground-level uses shall be along the public street.

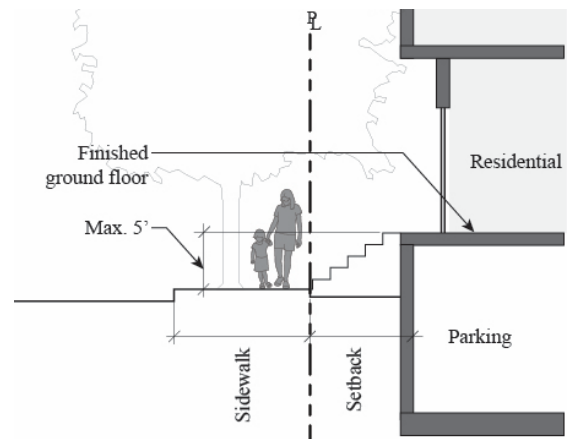

Fig. A.4: Finished ground floor elevation for residential developments within 5' of sidewalk.

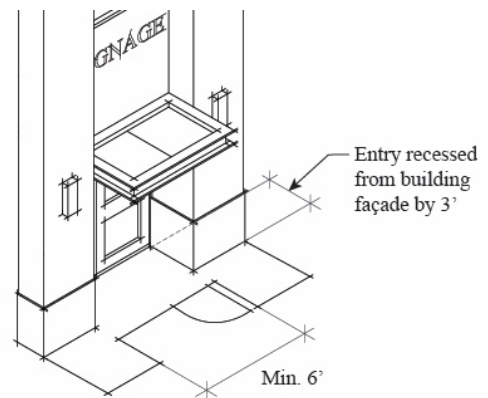

Fig. A.5: Building entrances shall be recessed by 3' from the public right-of-way.

- S2. Street-and public open space-facing entrances shall be recessed from the building facade by at least three feet creating a minimum six-foot wide entry alcove (see Fig. A.5). Existing non-conforming alcoves shall be updated to meet this standard if the street-facing building facade is structurally modified.
- S3. Ramps and/or steps provided at entrances shall not encroach in the public right-of-way.

### Guidelines

- G1. Access to individual ground floor residential units should include a transition from public to private areas using front porches, steps, stoops, landscaped setbacks, or similar features (see Fig. A.6).
- G2. Residential and commercial entrances in mixed-use developments should be distinct and easily identifiable.



Fig. A.6: Access to ground floor residential units from the sidewalk using stoops.

## 4. Windows

### Standards

- S1. At upper floor building facades, punched windows shall be provided.
- S2. A minimum of 90 percent of upper floor windows on street-or public open space-facing building facades shall be designed such that (see Fig. A.8):
  - a. The total width of windows is not greater than nine feet.
  - b. Windows are at least 12 inches apart.
  - c. Windows with width-to-height ratio greater than 2:3 shall include vertical mullions such that each panel is not greater than 2:3 width-to-height ratio.
- S3. Windows shall be inset from the building facade or window trim by at least two inches to create shade and shadow detail (see Fig. A.7).
- S4. Mirrored or reflective glass is not allowed on a street-or public open space-facing building facade at any level.

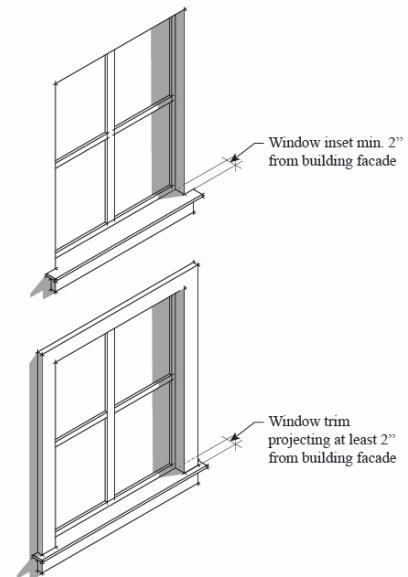

Fig. A.7: Windows inset from the building facade add to the richness of the building facade.



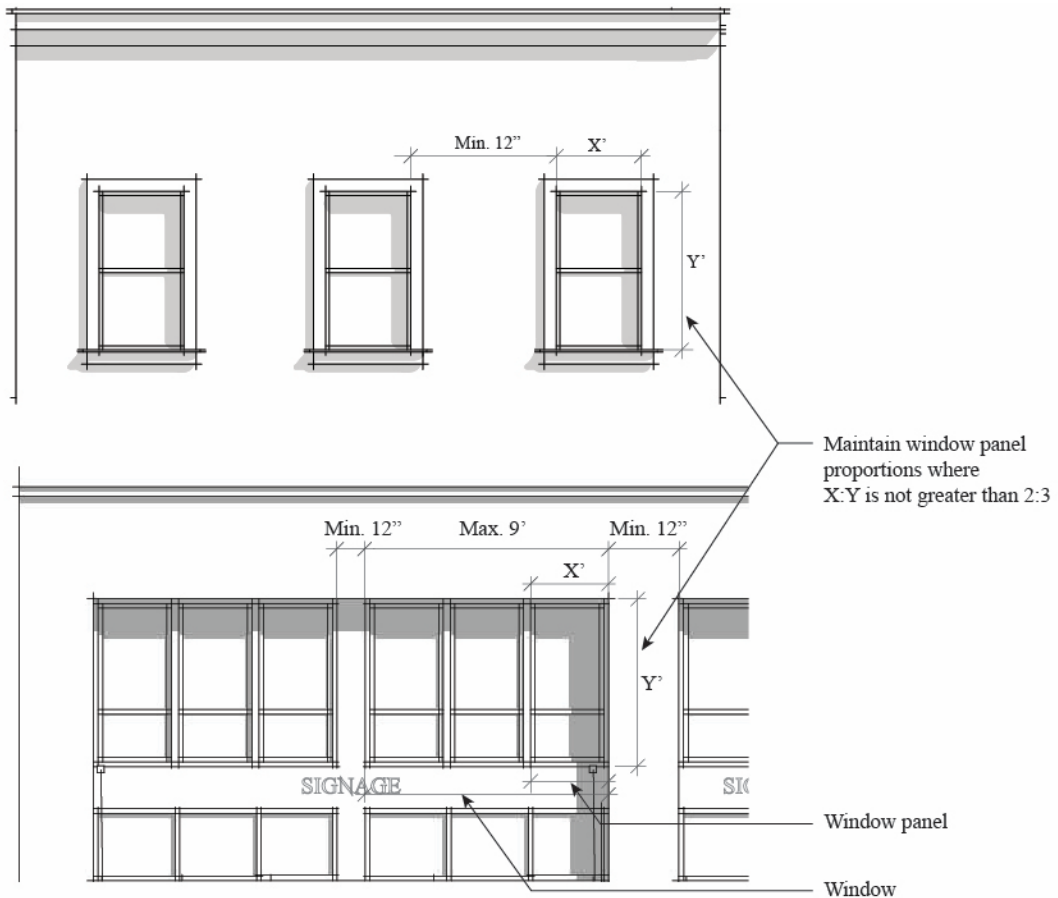

Fig. A.8: Upper floor windows shall have a vertical proportion.

## 5. Roof Treatment

### Standards

- S1. Continuous roof lines greater than 75 feet shall be broken up using stepbacks, changes in parapet or roof heights and/or by using a combination of roof forms (see Fig. A.10). This does not apply to stepback floors.
- S2. Parapet caps shall be provided at the street-facing building facade. Where provided, cornices and parapet caps shall be at least six inches deep and six inches tall (see Fig. A.9). This standard does not apply to stepback floors.
- S3. Rooftop equipment shall be fully screened from public/street view using architectural elements including but not limited to parapets and screens.

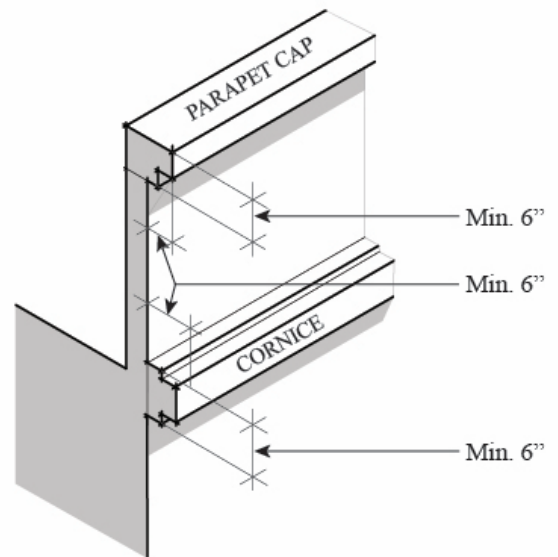

Fig. A.9: An example of roofs with a parapet cap and a cornice.

**Guidelines**

- G1. When roof decks are added as a common open space or recreational facility, all mechanical and service equipment should be screened from the common open space.

**6. Building Materials**

**Standards**

- S1. Street-facing and public open space-facing building facades shall have one primary material that has a traditional appearance, such as stone, brick, stucco, or wood.

**Guidelines**

- G1. Secondary materials for building facades may include modern and/or decorative elements such as glass, metal, tile etc.
- G2. Roofing materials and accenting features such as canopies, cornices, tile accents, etc. should offer color variation.
- G3. Residential building materials should include quality details such as wrought iron, wood-framed windows, wood brackets and tile roofs.

**7. Open Space**

**Standards**

- S1. Ground-level common open spaces that have walkways or pathways shall be at least 10 feet wide with a minimum of 6' wide walkway (see Fig. A.13).
- S2. Raised planters provided at street-facing or public open space-facing setbacks shall not be taller than three feet (see Fig. A.12).

**Guidelines**

- G1. Building setback areas along streets and common open spaces within a development should be landscaped using California native trees and/or shrubs.



Fig. A.10: Interesting roof forms are encouraged throughout the downtown.



Fig. A.11: Outdoor seating for commercial buildings along streets.

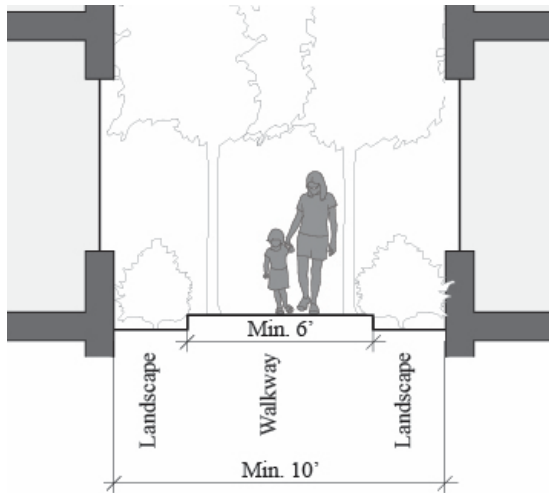

Fig. A.13: At least 10' wide open space with a minimum of 6' wide walkway.

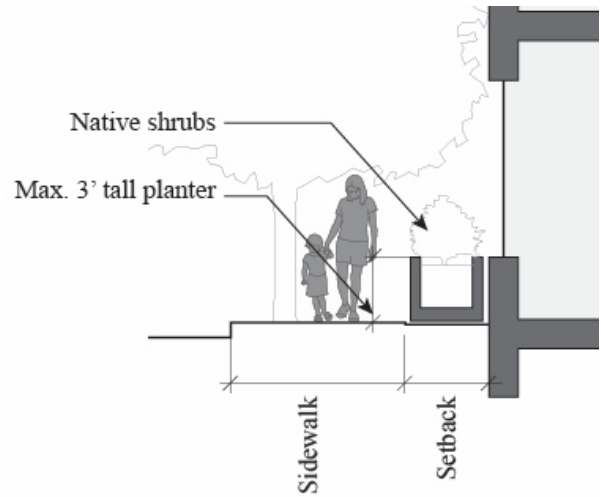

Fig. A.12: Raised planters in setbacks shall not be taller than 3'.

## 8. Parking

### Standards

- S1. When surface parking is provided on site, it shall be:
  - a. Setback at least five feet from the street- or public open space-facing property line.
  - b. Screened from the street using architectural and/or landscaping elements that are at least three feet but no greater than five feet tall.
- S2. Below grade parking shall not extend more than four feet above grade (see Fig. A.14).
- S3. Ventilation exhaust or equipment for below grade parking shall not front public sidewalks or accessways (except the alley). If located along a street-facing facade, there shall be a minimum five-foot wide landscape buffer between the building and the sidewalk (see Fig. A.14).

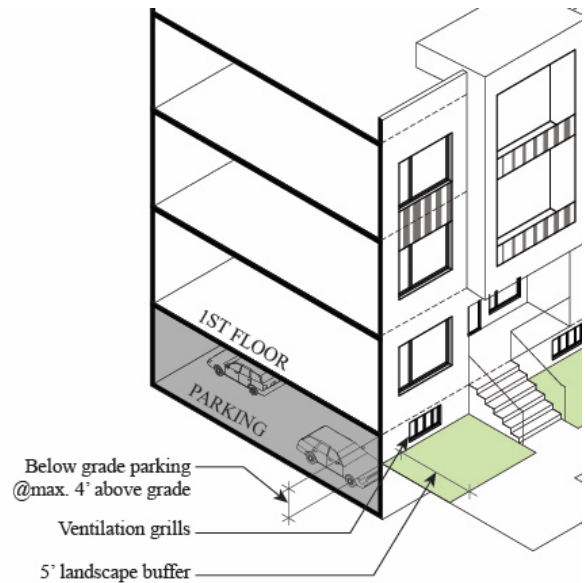

Fig. A.14: Below grade parking illustration.

### Guidelines

- G1. Where feasible, primary vehicle access should be from an alleyway that extends from Bryant Street to Franklin Street along the southern property lines of the residential areas.

## 9. Services and Trash Areas

### Standards

- S1. New food service uses and new buildings shall provide trash enclosures within the envelope of the building. Enclosures shall comply with any latest enclosure dimension standards.
- S2. Loading areas in new buildings shall be within the envelope of the building.
- S3. All trash service and loading access shall be off an alley, if available. If not available, it shall be located in a well-screened location, away from residential uses.
- S4. All trash and loading areas outside the building envelope shall be screened from public view using landscape and architectural elements (see Fig. A.15).



Fig. A.15: Trash area screened from public view using architectural elements.

### Guidelines

- G1. Screens, enclosures, and any other devices used to screen service facilities such as trash and loading areas should be consistent with the overall building architecture in form, material, and detail.

## 10. Site Access

### Standards

- S1. For developments with less than 50 parking spaces, a maximum of one curb cut shall be provided.
- S2. Curb cuts shall be a maximum of 12 feet wide for one-way driveways and a maximum of 22 feet for two-way driveways unless otherwise required by City ordinance or policy (see Fig. A.16).
- S3. Curb cuts and parking shall not take up more than 42 feet of any street- or public open space-facing frontage (see Fig. A.16).

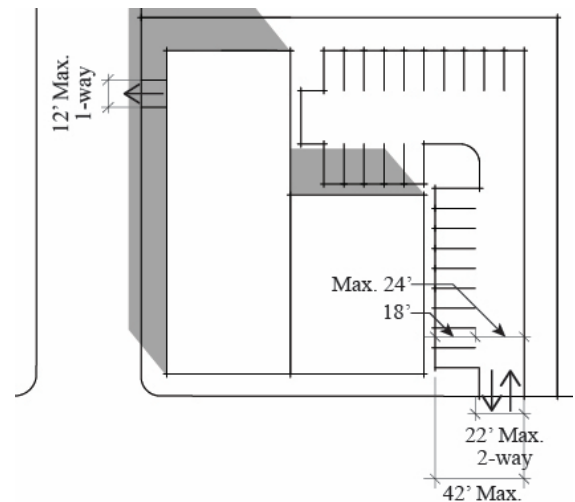

Fig. A.16: Diagram illustrating curb cut widths

### Guidelines

- G1. For developments with more than 50 parking spaces, no greater than two curb cuts should be provided.

## 11. Noise and Ground Vibrations

### Standards

- S1. Residential projects within 300' of Evelyn Avenue right-of-way shall prepare a noise and vibration analysis by a certified acoustical engineer identifying impacts and measures to reduce impacts.

## AREA G. TRANSIT CENTER BLOCK

### A. DEVELOPMENT STRATEGY

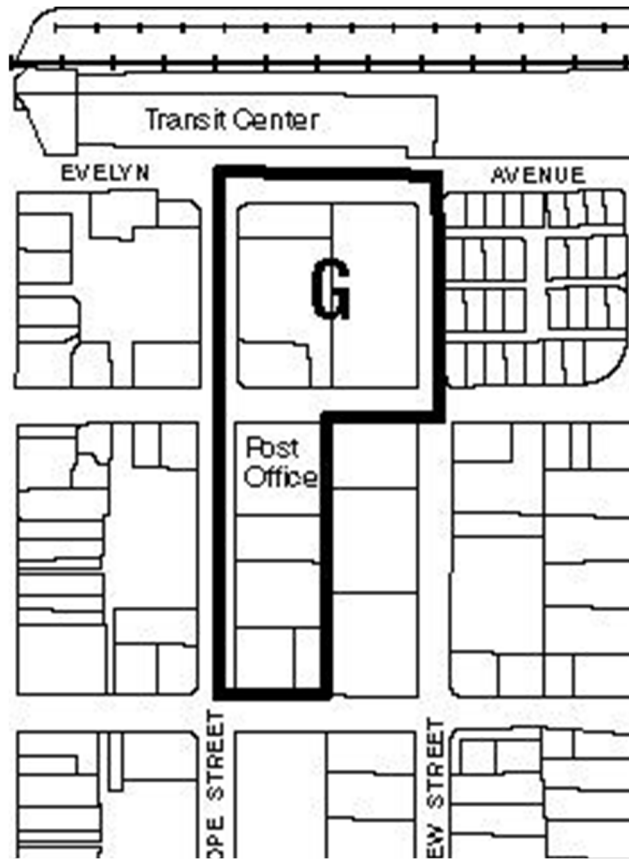

Fig. G1: Area G

The Transit Center block is appropriate for developments that provide a mix of businesses, services, and housing opportunities near the Transit Center. Developments must create a lively and active storefront environment creating an engaging entrance into the City.

Ground-floor retail stores and restaurants extending Castro Street storefront activity are encouraged in this area. Offices on the ground floor must enhance the public realm with increased pedestrian engagement and transparent facades. Residential uses should be primarily located on the upper levels particularly in the block closest to Evelyn Avenue.

The Transit Center is a major gateway to the downtown. New developments should be at least two stories and should be designed such that building facades are recognizable and distinctive from a distance (colorful canopies, fenestration, interesting roof forms, facade ornamentation, etc.). They should be a visual extension of the Castro Street commercial district and be sensitive to the traditional building size and storefronts on Castro Street.

Open space within the downtown area will have an urban character consistent with the Downtown and should act as an attractive buffer between uses and should be used to effectively articulate building forms, promote access to light and fresh air, and maintain privacy for downtown residents. It should also provide amenities to residents in residential developments and function as a visual amenity for non-residential uses. Landscaped open space areas should include evergreen trees for screening, specimen trees for visual color and attractive shrubs and ground cover. Landscape species should be California native or at minimum drought tolerant.

Parking requirements for Area G are described in Section II.C, Parking Standards and Policies. On-site parking should be fully below-grade to maintain an attractive and active storefront environment. Curb cuts should be minimized to promote traffic and pedestrian safety and create cohesive landscaping and building facades.

**B. USES**

Table G.1: List of Permitted and Provisional uses in Area G.

Use	Ground Level	Upper Level
Retail, not including drive-up or drive-in services	P	P
Art galleries	P	P
Personal services	P	P
Restaurants, including serving of alcoholic beverages clearly ancillary to food service; not including drive-up or drive-in services	PUP	PUP
Business services	P	P
Childcare centers	PUP	PUP
Hotels	PUP	PUP
Theaters, entertainment, and indoor recreational uses	PUP	PUP
Bars and nightclubs serving alcoholic beverages not ancillary to food service	PUP	PUP
Offices, not including administrative offices	P	P
Administrative offices	PUP	P
Residential, up to 50 units per acre	PUP	P
Efficiency studios	PUP	PUP
Senior housing at up to 60 units per acre	PUP	PUP
Surface parking in 100 block of Area G		
Surface parking (remaining Area G) and parking structures that exceed a height of 4' above finished grade;	PUP	PUP
Other businesses or service establishments which are determined by Zoning Administrator to be of similar character as listed in this table	PUP	PUP

P – Permitted Use; PUP – Provisional Use Permit

**C. DEVELOPMENT REQUIREMENTS**

For preservation and restoration of Historic Resources, refer to the Historic Ordinance for development requirements and standards.

Table G.2: List of Development Requirements

Criteria	Development Requirement
Maximum Height	50 feet (Decorative roof treatments and architectural features, such as a taller mass at the corner of a building, are allowed to exceed the maximum allowed height limit)
Maximum FAR	1.85
Minimum ground floor height (non-residential)	10 feet (finished floor to ceiling clear height)
Front Yard Setback	5 feet for residential ground-floor uses (No front yard building setback is required for commercial, office or mixed-use projects with residential on the upper levels)
Side Yard Setback	None required
Rear Yard Setback	15 feet for buildings; 5 feet for parking structures (below & at-grade) (see Fig. G.2)
Side and rear setbacks shall have trees that are 24-inch box size at a minimum spacing of 30 feet on center.	

Minimum Open Space	20 percent of the site area for non-residential developments; 30 percent of site area for residential developments (The Zoning Administrator may allow deviations from this requirement where it is found that it can improve the quality of the project or enhance the character of the Downtown district)
Upper Floor Stepbacks	Stepback is required for structures adjacent to historic resources. Encroachment in the stepback is allowed for block corner features for a maximum width of 20 feet.
Finished ground floor elevation (residential units)	Within 5 feet above sidewalk level (see Fig. G.5)

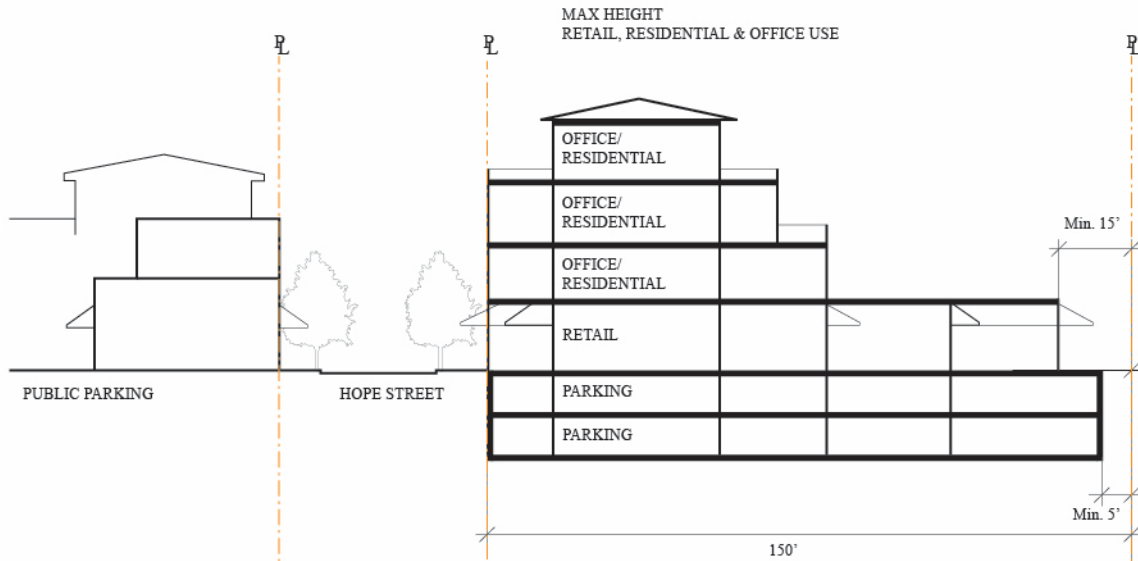

Fig. G.2: Illustrative Section Area G.

**D. DEVELOPMENT STANDARDS AND GUIDELINES**

**1. Development Massing**

**Standards**

- S1. For developments adjacent to historic buildings, the building massing shall step down to be a maximum of 10 feet taller than the height of the adjacent historic building for a minimum of 10 feet from it (see Fig. G.3).
- S2. A character change shall be provided at least every 75 feet (see Fig. G.3). Character changes include at least two of the following: changes to primary colors, changes to primary materials, and changes to primary wall planes. Projects may elect to provide a massing break in lieu of or in addition to a character change. Massing breaks shall be minimum four feet deep and 10 feet wide.

**Guidelines**

- G1. Massing breaks, stepbacks and/or step-downs should be provided to create transition to existing surrounding developments.
- G2. Special corner features should be incorporated at corner parcels. These may include but are not limited to display windows, corner roof features, taller massing, and change in materials (see Fig. G.3). See Table G.2 for allowed exceptions for corner features.

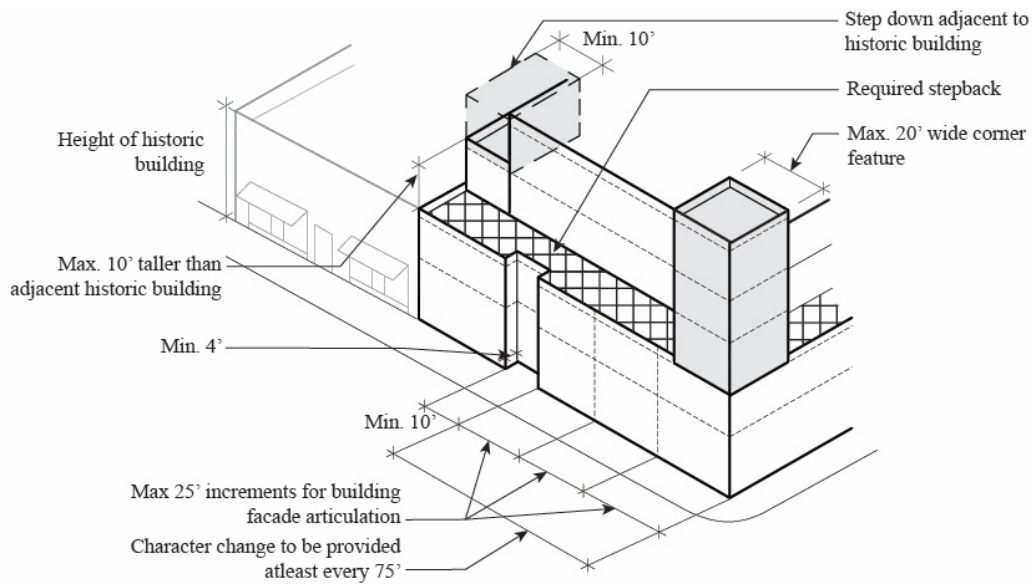

Fig. G.3: Example of stepdown adjacent to historic buildings and taller massing at the block corner.

## 2. Ground Level Treatment and Facade Articulation

### Standards

- S1. Street- and public open space-facing building facades shall be articulated in increments of up to 25 feet width using architectural and structural elements such as columns, fenestration patterns, entry alcoves, or changes in facade planes and materials (see Fig. G.3).
- S2. A minimum of 50 percent of the ground floor commercial frontage area along streets and public open spaces shall be transparent facades (see Fig. G.4). Doors providing 40 percent glazing on the ground floors in locations mentioned shall count toward the requirement.
- S3. When a base is provided along a street-facing building facade, it shall be limited to 30 inches in height at grade and project a maximum of six inches from the building facade (see Fig. G.4).
- S4. Street-facing canopies are allowed to extend up to six feet over the sidewalk and shall have a minimum vertical clearance of eight feet (see Fig. G.4).

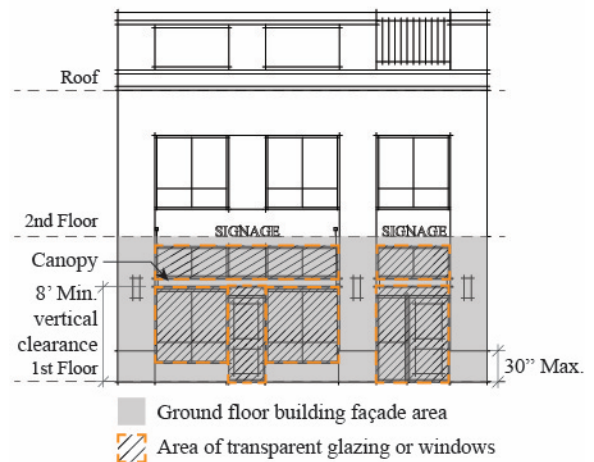

Fig. G.4: Transparent ground floor commercial frontage helps increase the liveliness of the streets.

### Guidelines

- G1. Commercial development should meet ground-level treatment guidelines outlined in the Historic Retail District.

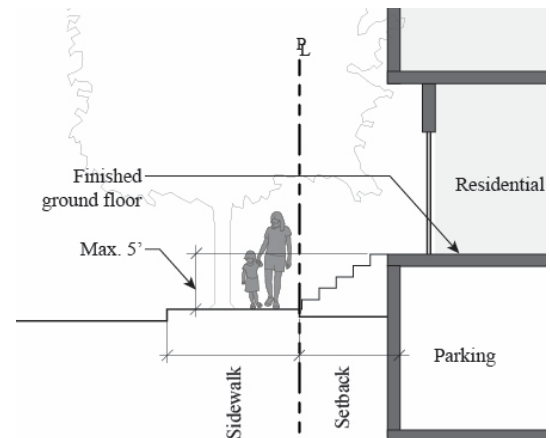

Fig. G.5: Finished ground floor elevation for residential developments within 5' of sidewalk.



- G2. Pedestrian-level detailing should include storefront detailing, facade ornamentation, special materials, flower boxes and other improvements to reinforce the pedestrian nature.

### 3. Entrances

#### Standards

- S1. Street-and public open space-facing entrances shall be recessed from the building facade by at least three feet creating a minimum six-foot wide entry alcove (see Fig. G.7). Existing non-conforming alcoves shall be updated to meet this standard if the street-facing building facade is structurally modified.
- S2. Multiple entrances within a building shall be no more than 50' apart on center (see Fig. G.8).
- S3. Ramps and/or steps provided at entrances shall not encroach in the public right-of-way.



Fig. G.6: Access to ground floor residential units from the sidewalk using stoops.

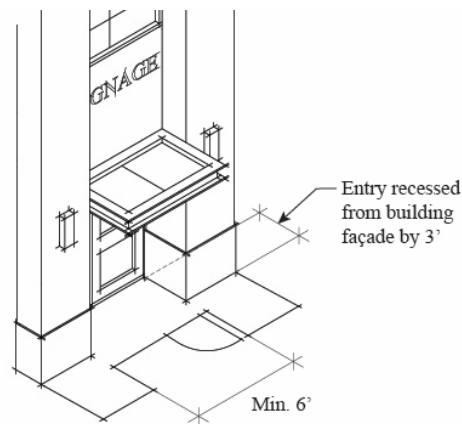

Fig. G.7: Entry recessed from street-facing building facade to create an alcove.

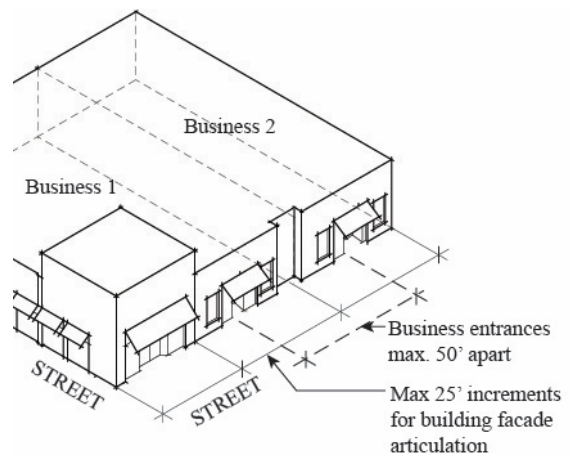

Fig. G.8: Facade articulations at 25' intervals with business entrances at a maximum of 50'.

#### Guidelines

- G1. Access to individual ground floor residential units should include a transition from public to private areas using front porches, steps, stoops, landscaped setbacks, or similar features (see Fig. G.6).

## 4. Windows

### Standards

- S1. At upper floor building facades, punched windows shall be provided.
- S2. A minimum of 90 percent of upper floor windows on street-or public open space-facing building facades shall be designed such that (see Fig. G.10):
  - a. The total width of windows is not greater than nine feet.
  - b. Windows are at least 12 inches apart.
  - c. Windows with width-to-height ratio greater than 2:3 shall include vertical mullions such that each panel is not greater than 2:3 width-to-height ratio.

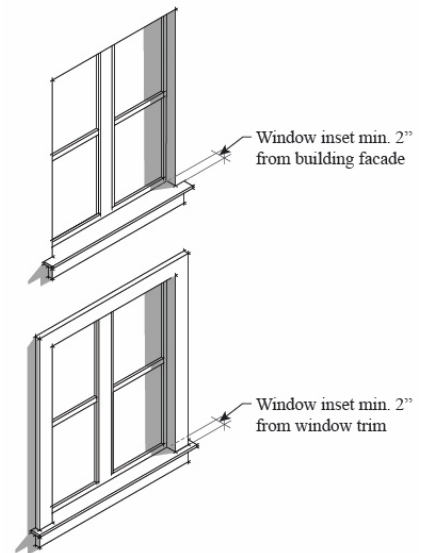

Fig. G.9: Windows inset from the building facade add to the richness of the building facade.

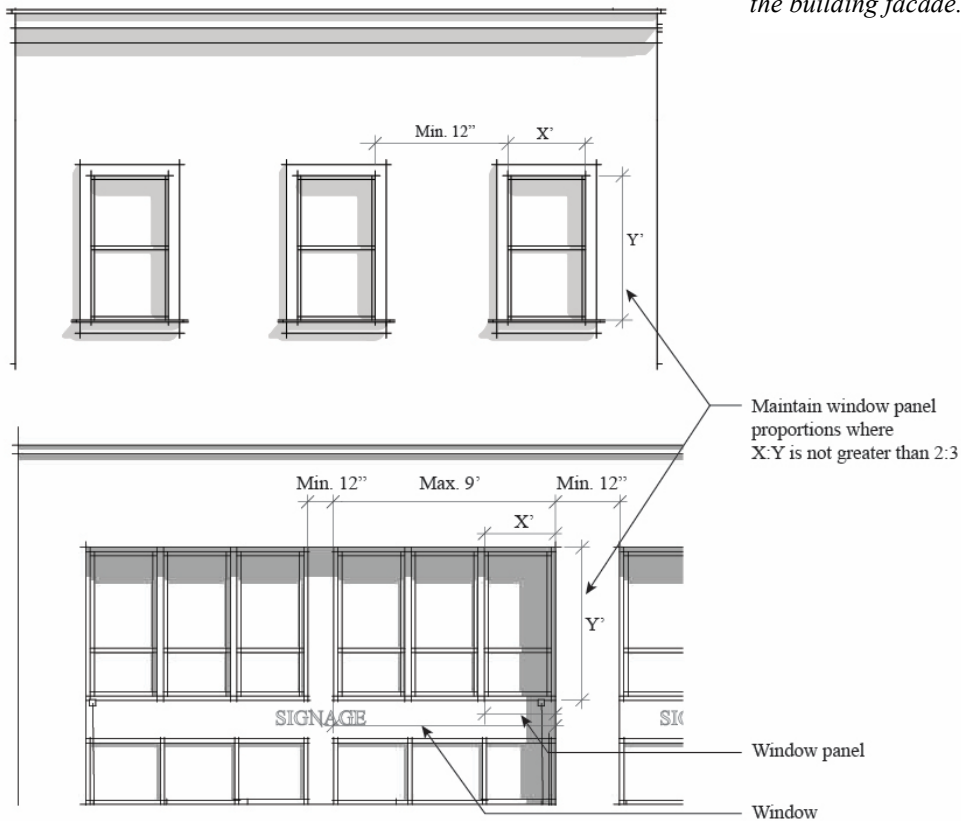

Fig. G.10: Upper floor window panels shall have a vertical proportion.

- S3. Windows shall be inset from the building facade or window trim by at least two inches to create shade and shadow detail (see Fig. G.9).
- S4. Mirrored or reflective glass is not allowed on a street-or public open space-facing building facade at any level.

## 5. Roof Treatment

### Standards

- S1. Continuous roof lines greater than 75 feet shall be broken up using stepbacks, changes in parapet or roof heights and/or by using a combination of roof forms (see Fig. G.12). This does not apply to stepback floors.
- S2. Parapet caps shall be provided at the street-facing building facade. Where provided, cornices and parapet caps shall be at least six inches deep and six inches tall (see Fig. G.11). This standard does not apply to stepback floors.
- S3. Rooftop equipment shall be fully screened from public/street view using architectural elements including but not limited to parapets and screens.

### Guidelines

- G1. When roof decks are added as a common open space or recreational facility, all mechanical equipment and service rooms should be screened from the common space.

## 6. Building Materials

### Standards

- S1. Street-facing and public open space-facing building facades shall have one primary material that has a traditional appearance, such as stone, brick, stucco, or wood.

### Guidelines

- G1. Secondary materials for building facades may include modern and/or decorative elements such as glass, metal, tile etc.
- G2. Building facade materials should be light in color, i.e. earth tones, pastels or whites accented with dark or bright colors
- G3. Roofing materials and accenting features such as canopies, cornices, tile accents, etc. should offer color variation.
- G4. Residential building materials should include quality details such as wrought iron, wood-framed windows, wood brackets and tile roofs.

## 7. Open Space

### Standards

- S1. Ground-level common open spaces that have walkways or pathways shall be at least 10 feet wide open space with a minimum of 6' wide walkway (see Fig. G.14).

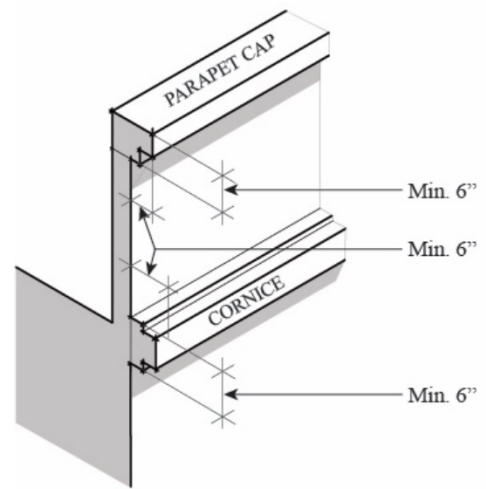

Fig. G.11: An example of roofs with a parapet cap and a cornice.



Fig. G.12: Interesting roof forms are encouraged throughout the downtown.

- S2. Raised planters provided in street-facing or public open space-facing setbacks shall not be taller than three feet (see Fig. G.13).

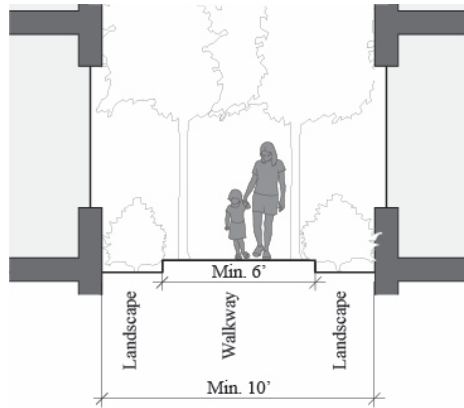

Fig. G.14: At least 10' wide open space with a minimum of 6' wide walkway.

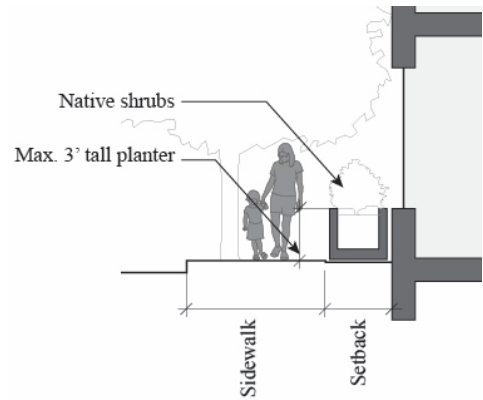

Fig. G.13: Raised planters in setbacks shall not be taller than 3'.

**Guidelines**

- G1. Building setback areas along streets and common open spaces within a development should be landscaped using California native trees and/or shrubs.

**8. Parking**

**Standards**

- S1. Ventilation exhaust or equipment for below grade parking shall not front public sidewalks or accessways (except the alley). If located along a street-facing facade, there shall be a minimum five-foot wide landscape buffer between the building and the sidewalk (see Fig. G.15).

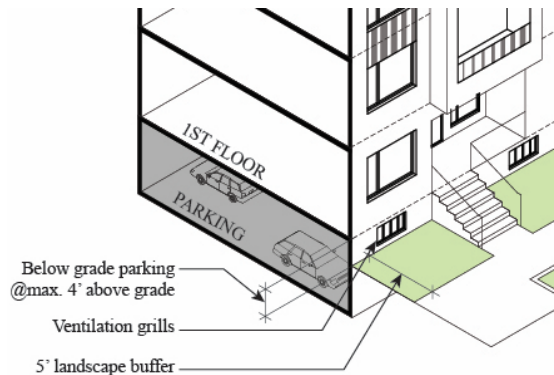

Fig. G.15: Below grade parking illustration.

**9. Services and Trash Areas**

**Standards**

- S1. New food service uses and new buildings shall provide trash enclosures within the envelope of the building. Enclosures shall comply with any latest enclosure dimension standards.
- S2. Loading areas in new buildings shall be within the envelope of the building.
- S3. All trash service and loading access shall be off an alley, if available. If not available, it shall be located in a well-screened location, away from residential uses.

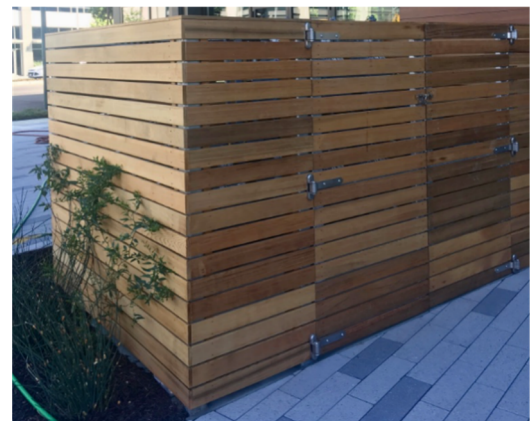

Fig. G.16: Trash area screened from public view using architectural elements.

- S4. All trash and loading areas outside the building envelope shall be screened from public view using landscape and architectural elements (*see Fig. G.16*).

### Guidelines

- G1. Screens, enclosures, and any other devices used to screen service facilities such as trash and loading areas should be consistent with the overall building architecture in form, material, and detail.

## 10. Site Access

### Standards

- S1. For developments with less than 50 parking spaces, a maximum of one curb cut shall be provided.
- S2. For developments with more than 50 parking spaces, no greater than two curb cuts shall be provided.
- S3. Curb cuts shall be a maximum of 12 feet wide for one-way driveways and a maximum of 22 feet for two-way driveways unless additional width is required for safety and operations (*see Fig. G.17*).
- S4. Curb cuts and parking shall not take up more than 42 feet of any street- or public open space-facing site frontage (*see Fig. G.17*).

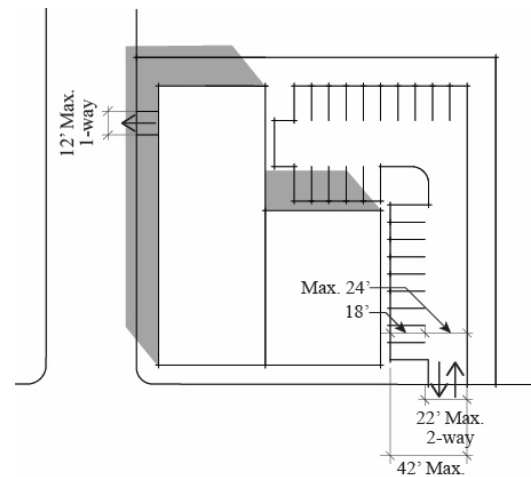

Fig. G.17: Diagram illustrating curb cut widths.

## AREA H. HISTORIC RETAIL DISTRICT

### A. DEVELOPMENT STRATEGY



Fig. H.1: Area H



Fig. H.2: The annual Downtown Art and Wine Festival.

A critical development objective includes the enhancement of Castro Street as the principal focus of the downtown and as a lively pedestrian spine with continuous active retail and restaurant uses. The first three blocks of Castro Street contain the historic retail core of Mountain View with some buildings dating to the late 19th and early 20th Centuries. The buildings in Area H are a mixture of ages and architectural styles, but there are unifying characteristics including limited height, narrow building widths and small storefronts that create a fine-grained pedestrian scale and a continuous frontage of retail and restaurant uses. A major component of the development strategy of this area is to reinforce this continuity and strengthen the pedestrian environment by requiring all new development to provide active ground-level uses.

Area H is in the Parking District, where most parking is in public lots and shared garages. The principal objective is to reinforce the active pedestrian-oriented uses along Castro Street and its immediate side streets. Parking requirements for this area will depend on the use (see Section II.C).

New development should be sensitive infill development within the small parcel increments of the area. Larger tenant spaces should maintain the comfortable pedestrian scale of Castro Street and ensure an appropriate transition between new development and the “fabric” of existing structures.

This is particularly important in the 100 and 200 blocks of Castro Street where several older buildings are located. Section E - Design Guidelines (for Area H) emphasize the importance of reinforcing the character of downtown.

**B. USES**

**Standards**

- S1. Ground level provisional uses fronting on Castro and Cross Streets will only be allowed if they can sufficiently demonstrate that they will generate pedestrian activity and streetside interest compatible with the desired Castro Street environment described in the goals and objectives for the downtown. The criterion of generating pedestrian traffic is most critical for establishments fronting Castro Street.
- S2. Ground level administrative offices fronting Castro and Cross Streets, which were made legal nonconforming on (update adoption date), may be allowed to continue. If vacant for a period of six months or more, re-occupation of such spaces with administrative office is allowed under the conditions of any previously issued Provisional Use Permit applicable to that space. Upon conversion to a currently allowed use (permitted or provisional), that space shall no longer be allowed administrative office.

Table H.1: List of Permitted and Provisional uses in Area H.

Use	Fronting on Castro & Cross Streets**		Other locations	
	Ground Level	Upper Levels	Ground Level	Upper Levels
Retail, not including drive-up or drive-in services	P	P	P	P
Art galleries	P	P	P	P
Personal services	P	P	P	P
Restaurants, including serving of alcoholic beverages clearly ancillary to food service; not including drive-up or drive-in services	PUP	PUP	PUP	PUP
Business services	PUP	P	P	P
Banks and financial institutions	PUP	P	P	P
Medical services	PUP	P	P	P
Hotels	PUP	PUP	PUP	PUP
Theaters	PUP			
Bars, nightclubs, establishments providing entertainment or permitting dancing, and establishments serving alcoholic beverages not ancillary to food service	PUP			
Lodges, Clubs, social or fraternal organizations	PUP	P	P	P
Indoor recreation uses	PUP	PUP	PUP	PUP
Offices, not including administrative offices	PUP	P	P	P
Administrative offices	*	PUP	PUP	PUP
Residential, up to 50 units per acre	*	PUP	*	PUP
Other businesses or service establishments which are determined by Zoning Administrator to be of a similar character as listed in this table	PUP	PUP	PUP	PUP

P – Permitted Use; PUP – Provisional Use Permit

\* Lobbies and access to upper floors are allowed (See *Ground Level Treatment & Façade Articulation, S5*).

\*\* Does not apply to the frontage along W Evelyn Ave between Bryant St and Castro St.

**C. DEVELOPMENT REQUIREMENTS**

For preservation and restoration of Historic Resources, refer to the Historic Ordinance for development requirements and standards.

Table H.2: List of Development Requirements

Development Requirement	Castro Street		Other locations
	100-200 blocks (Evelyn Avenue to Dana Street)	Block 300 (West Dana Street to California Street)	
Maximum Height	50 feet	55 feet	55 feet
	Decorative roof treatments and architectural features, such as a taller mass at the corner of a building, are allowed to exceed the maximum allowed height limit (see Fig. H.4).		
Floor Area Ratio (FAR)	2.75 (Only applies to Office, other uses are exempt from FAR. Office developments greater than 2.75 FAR may be allowed to continue.)		
Upper Floor Stepbacks	10-foot stepback above 40 feet from the ground level	10-foot stepback above 45 feet from the ground level	4-foot stepback above 45 feet from the ground level (none required for streets parallel to Castro Street)
	Encroachment in the stepback is allowed for block corner features for a maximum width of 20 feet.		
Minimum ground floor height	10 feet (finished floor to ceiling clear height)		
Minimum depth of retail or restaurant space	40 feet (for corner lots at least one depth shall be a minimum of 40 feet, the other depth shall be at least 25 feet). The Zoning Administrator may allow shallower commercial spaces where development is constrained by parcel dimensions or necessary improvements, such as trash rooms or exiting.		
Maximum allowed Building Coverage	100 percent		
Build-to Lines	All developments shall be built to the back of the proposed sidewalk. Mid-block pedestrian passages that encourage through-block pedestrian circulation and/or arcaded spaces that create wider sidewalk areas for cafés, etc. are encouraged.		
Setbacks (Side and Rear Yards)	None required		
Maximum building length	125' along Castro Street frontage	No maximum	
Open Space	A minimum of 30 percent of the site area must be devoted to open space for residential/mixed-use projects. The Zoning Administrator may allow deviations from this requirement where it is found that it can improve the quality of the project or enhance the character of the Downtown.		
Minimum Open Space Width	10 feet		
Parking	As described in Section II.C, Parking Standards and Policies		



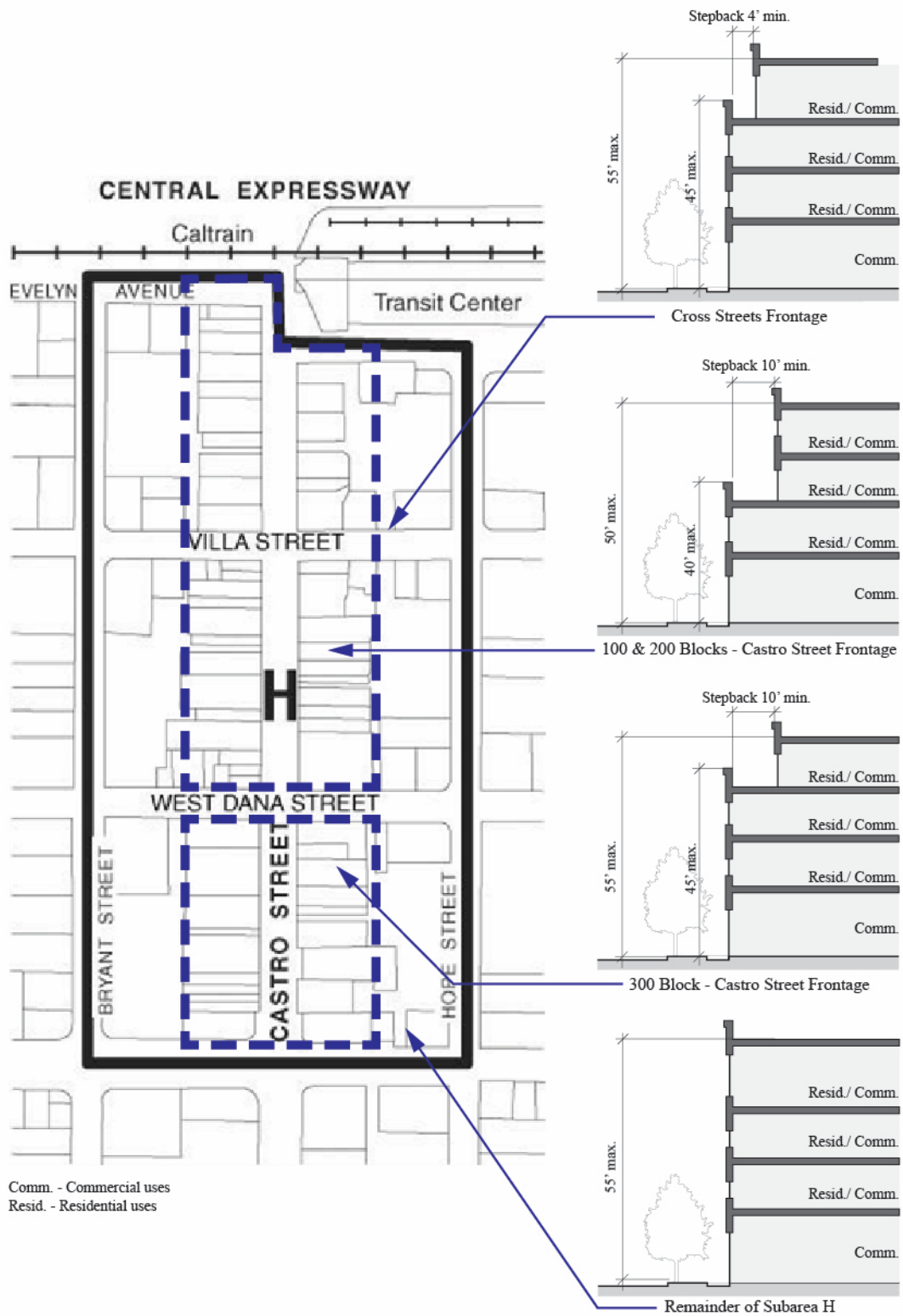

Fig. H.3: Area H - Height Illustration

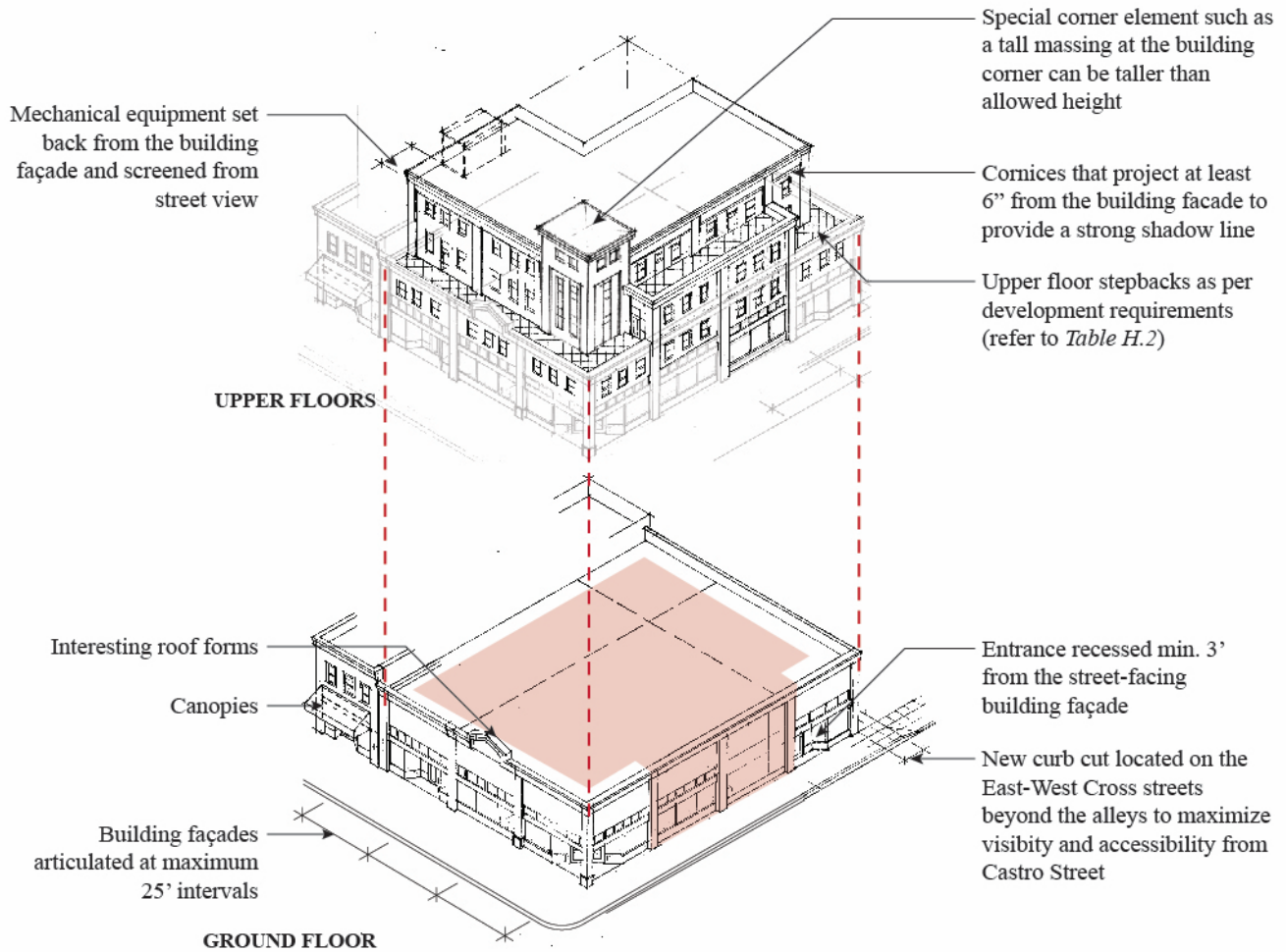

Fig. H.4: An example of development massing in Area H.

## D. DEVELOPMENT STANDARDS AND GUIDELINES

### 1. Development Massing

#### Standards

- S1. For developments adjacent to historic buildings, the building massing shall step down to be a maximum of 10 feet taller than the height of the adjacent historic building for a minimum of 10 feet (see Fig. H.5).
- S2. A character change shall be provided at least every 75 feet (see Fig. H.5). Character changes include at least two of the following: changes to primary colors, changes to primary materials, and changes to primary wall planes. Projects may elect to provide a massing break in lieu of or in addition to a character change. Massing breaks shall be minimum four feet deep and 10 feet wide.

**Guidelines**

- G1. Massing breaks, stepbacks and/or step-downs should be provided to create transition to existing surrounding developments.
- G2. Special corner features should be incorporated at corner parcels. These may include but are not limited to display windows, corner roof features, taller massing, and change in materials (see Fig. H.5). See Table H.2 for allowed exceptions for corner features.

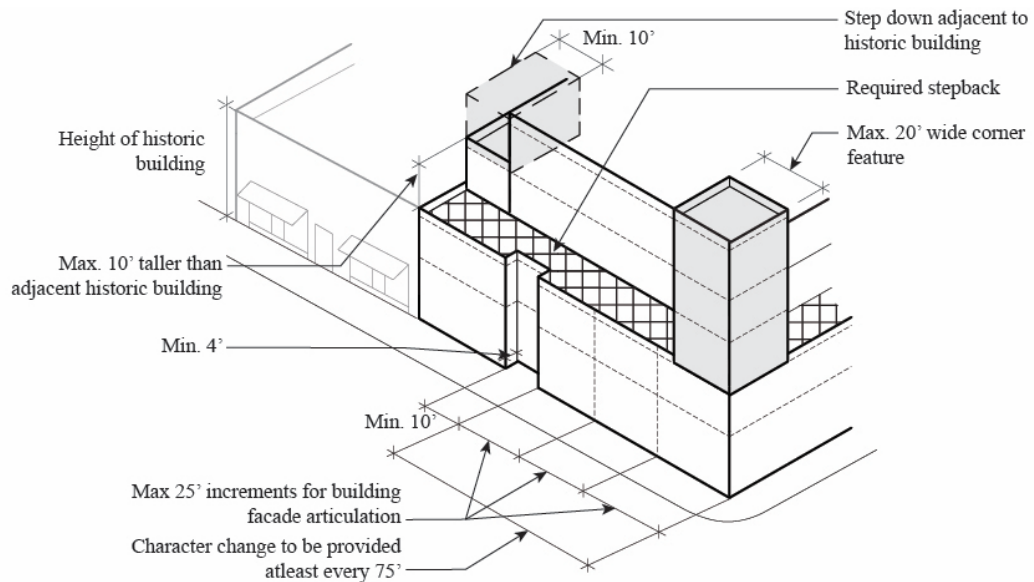

Fig. H.5: Example of stepdown adjacent to historic buildings and taller massing at the block corner.

**2. Ground Level Treatment and Facade Articulation**

**Standards**

- S1. Street- and public open space-facing building facades shall be articulated in increments of up to 25 feet width using architectural and structural elements such as columns, fenestration patterns, entry alcoves, or changes in facade planes and materials (see Fig. H.5).
- S2. A minimum of 60 percent of the ground floor building facade area along Castro Street and 45 percent of the ground floor building facade area along Cross Streets shall have windows or doors (see Fig. H.6 and Fig. H.8). Doors providing 40 percent glazing on the ground floors in locations mentioned shall count toward the requirement.

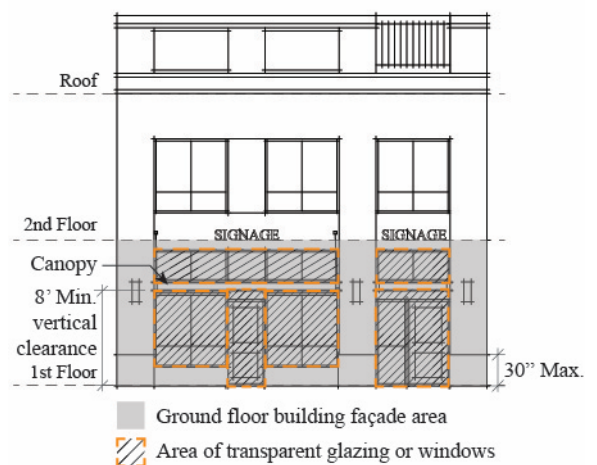

Fig. H.6: Transparent ground floor commercial frontage helps increase the liveliness of the streets.

- S3. When a base is provided along a street-facing building facade, it shall be limited to 30 inches in height and project a maximum of six inches from the building facade (see Fig. H.6 and Fig. H.8).
- S4. Street-facing canopies are allowed to extend up to six feet over the sidewalk and shall have a minimum vertical clearance of eight feet (see Fig. H.7 and Fig. H.8).
- S5. When ground floor lobbies are provided at corner parcels along Castro Street, they shall only be located along Cross Streets such that they are at minimum 25 feet from the intersection of the property lines (see Fig. H.9).



Fig. H.7: Canopies help provide a pedestrian scale to the building.

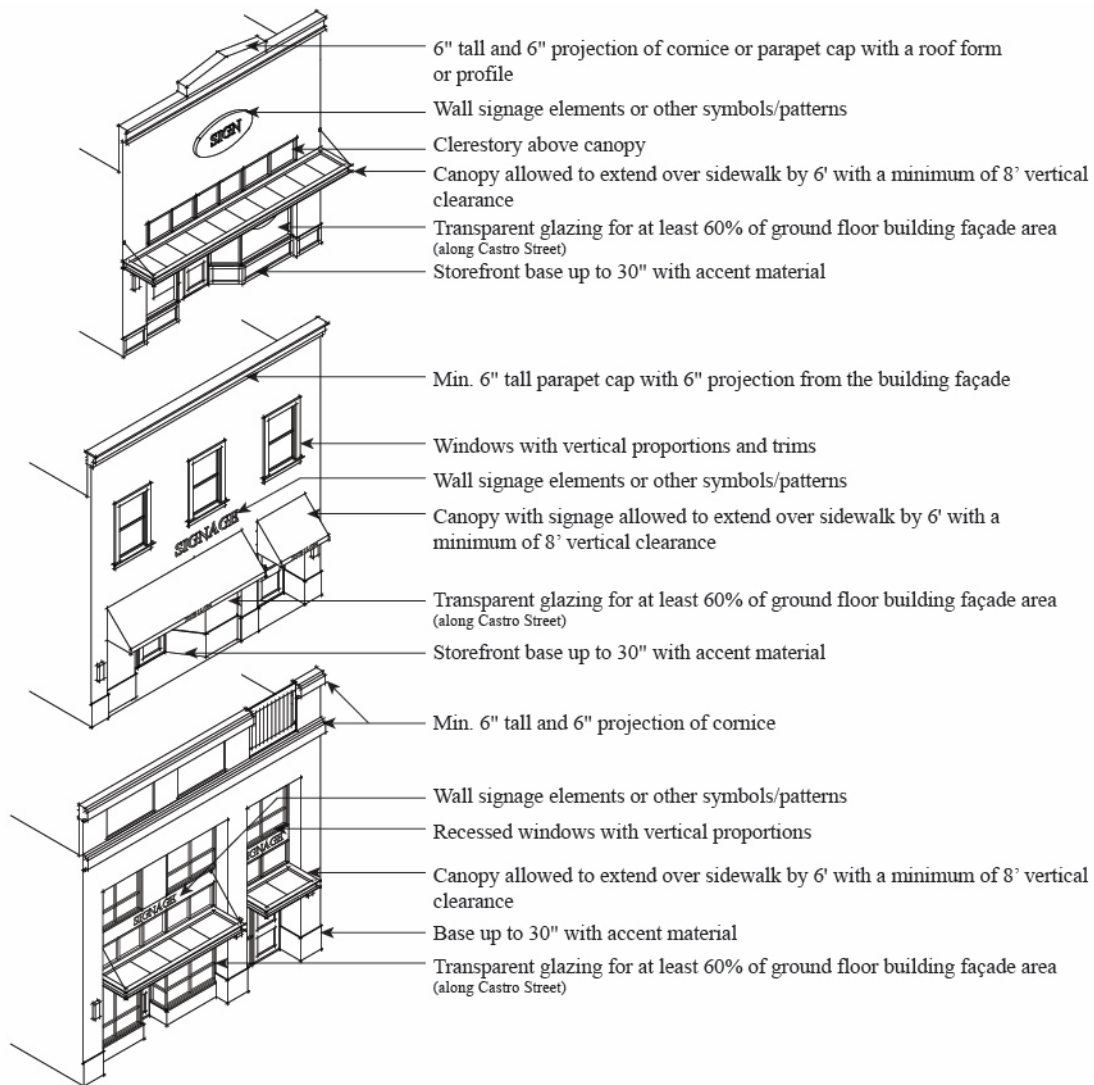

Fig. H.8: Example of building facades with different architectural styles utilizing the same design features such as roof articulation, canopies, windows etc.

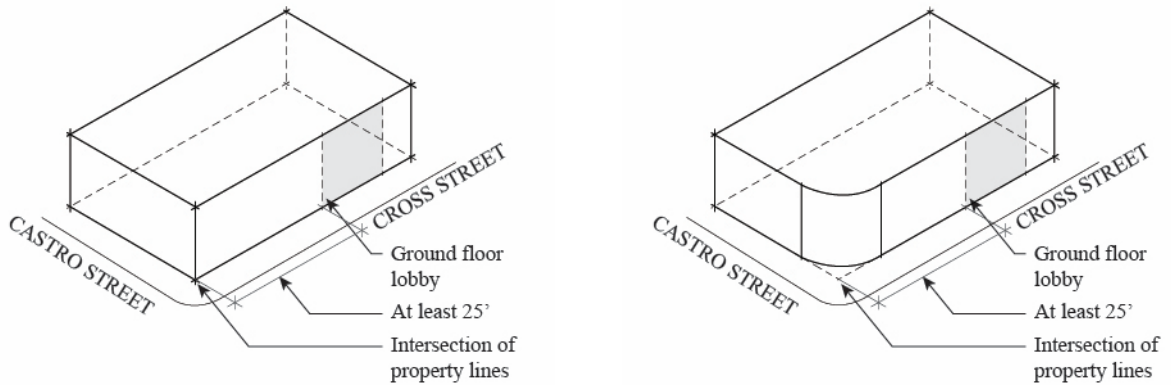

Fig. H.9: Ground floor lobbies shall be at least 25' from the intersection of property lines at corner parcels.

### 3. Entrances

#### Standards

- S1. Street- and public open space-facing entrances shall be recessed from the building facade by at least three feet creating a minimum six-foot wide entry alcove (see Fig. H.11 and Fig. H.10). Existing non-conforming alcoves shall be updated to meet this standard if the street-facing building facade is structurally modified.
- S2. Along Castro Street, any building greater than 75' wide shall be structurally designed to allow for multiple entrances, no more than 50' apart (see Fig. H.12).
- S3. Ramps and/or steps provided at entrances shall not encroach in the public right-of-way.



Fig. H.10: Entry alcove at street-facing building facade.

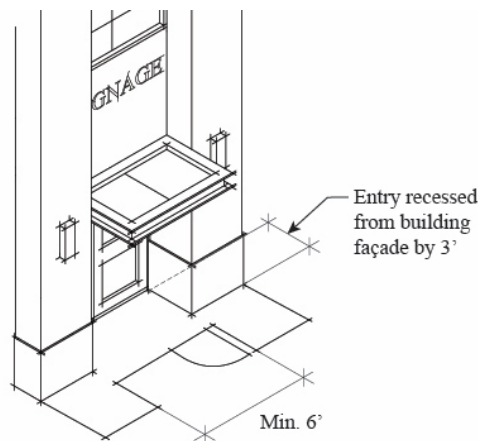

Fig. H.11: Entry recessed from street-facing building facade to create an alcove.

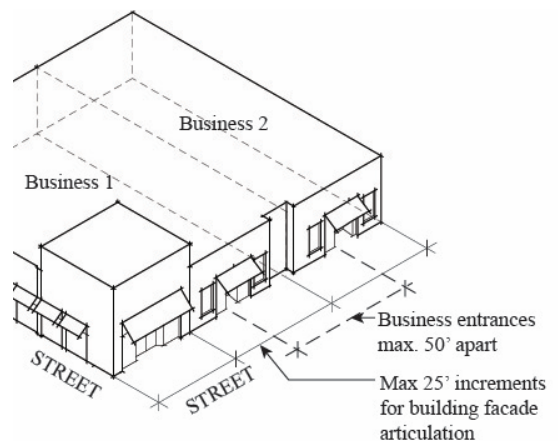

Fig. H.12: Facade articulations at 25' intervals with business entrances at a maximum of 50'.

## 4. Windows

### Standards

- S1. At upper floor building facades, punched windows shall be provided.
- S2. A minimum of 90 percent of upper floor windows on street-or public open space-facing building facades shall be designed such that (see Fig. H.14):
  - a. The total width of windows is not greater than nine feet.
  - b. Windows are at least 12 inches apart.
  - c. Windows with width-to-height ratio greater than 2:3 shall include vertical mullions such that each panel is not greater than 2:3 width-to-height ratio.
- S3. Windows shall be inset from the building facade or window trim by at least two inches to create shade and shadow detail (see Fig. H.13).
- S4. Mirrored or reflective glass is not allowed on a street-or public open space-facing building facade at any level. Only transparent glass shall be used for windows or glazing at the ground floor.

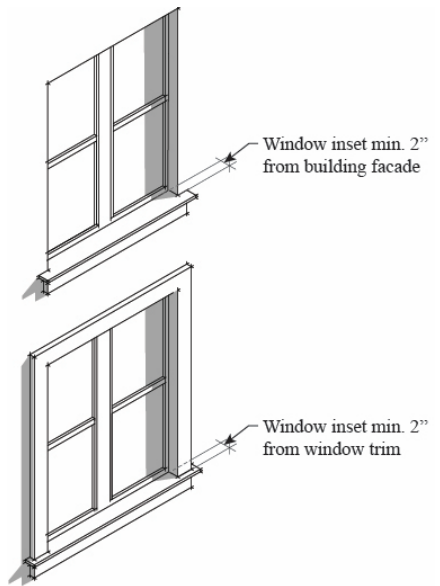

Fig. H.13: Punched windows add to the richness of the building facade.

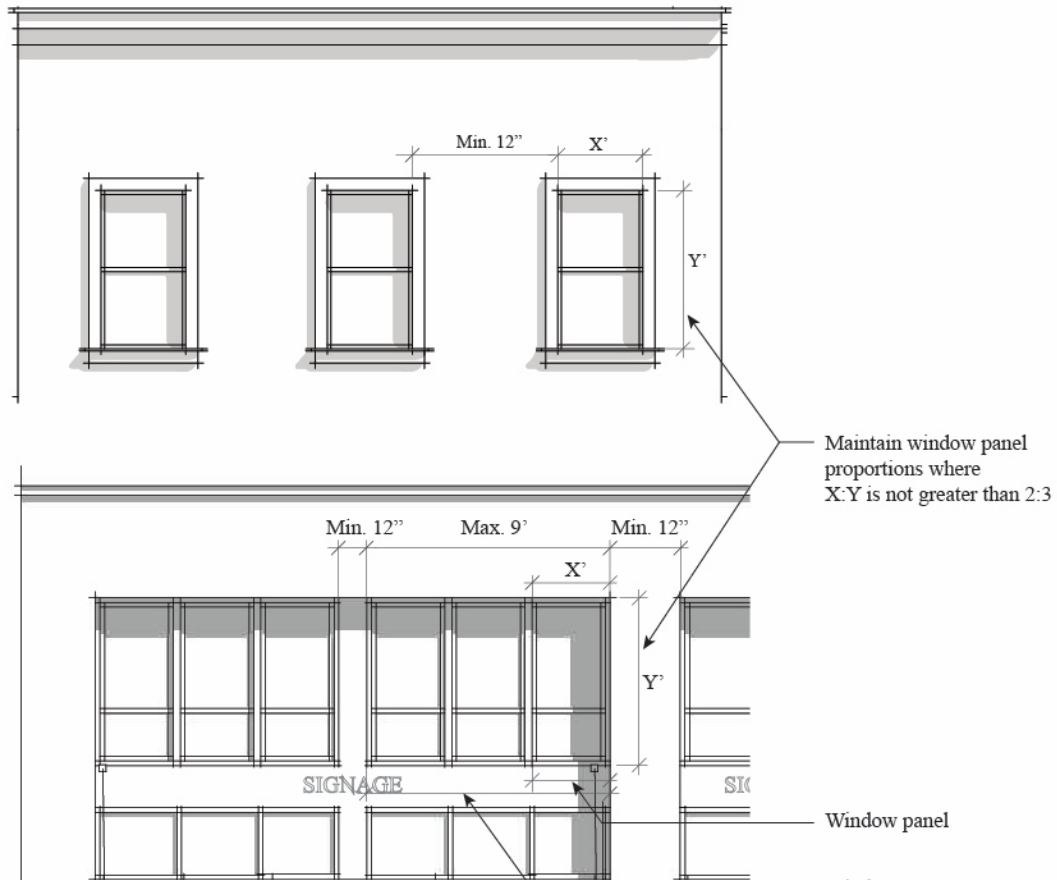

Fig. H.14: Upper floor windows shall have a vertical proportion.

## 5. Roof Treatment

### Standards

- S1. Continuous roof lines for street-or public open space-facing building facades longer than 75 feet shall be broken up using changes in parapet or roof heights and/or by using a combination of roof forms (see Fig. H.16). This does not apply to building facades at stepback floors.
- S2. Parapet caps shall be provided at the street-facing building facade. Where provided, cornices and parapet caps shall be at least six inches deep and six inches tall (see Fig. H.8 and Fig. H.15).
- S3. Rooftop equipment shall be fully screened from public/street view using architectural elements including but not limited to parapets and screens.

### Guidelines

- G1. When roof decks are added as a common open space or recreational facility, all mechanical equipment and service rooms should be screened from the common space.

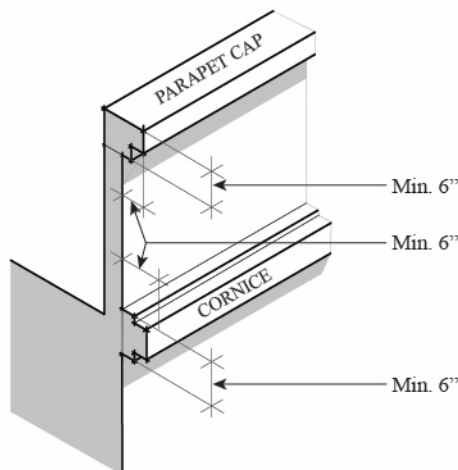

Fig. H.15: An example of roofs with a parapet cap and cornice.



Fig. H.16: Continuous roof lines broken up using parapet articulation.

## 6. Building Materials

### Standards

- S1. Street-facing and public open space-facing building facades shall have one primary material that has a traditional appearance, such as stone, brick, stucco, or wood.

## 7. Open Space

### Standards

- S1. Ground-level common open spaces that have walkways or pathways shall be at least 10 feet wide with a minimum of 6' wide walkway (see Fig. H.17).
- S2. Raised planters provided in street-facing or public open space-facing setbacks shall not be taller than three feet (see Fig. H.18).

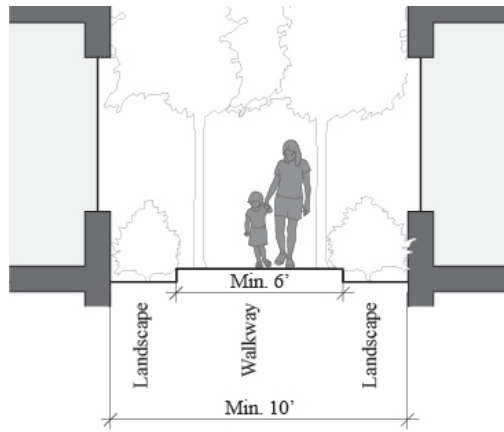

Fig. H.17: At least 10' wide open space with a minimum of 6' wide walkway.

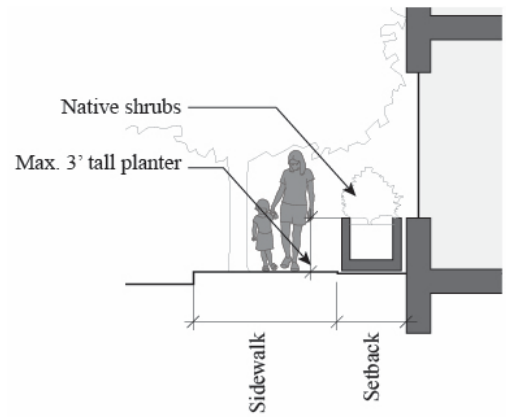

Fig. H.18: Raised planters in setbacks shall not be taller than 3'.

**Guidelines**

- G1. Building setback areas along streets and public open spaces within a development should be landscaped using California native trees, shrubs and/or plants.

**8. Services and Trash Areas**

**Standards**

- S1. New food service uses and new buildings shall provide trash enclosures within the envelope of the building. Enclosures shall comply with any latest enclosure dimension standards.
- S2. Loading areas in new buildings shall be within the envelope of the building.
- S3. All trash service and loading access shall be off an alley, if available. If not available, it shall be located in a well-screened location, away from residential uses.



Fig. H.19: Raised planters in setbacks shall not be taller than 3'.



Fig. H.20: Service facilities should be screened with enclosures and devices consistent with the building architecture.



- S4. All trash and loading areas outside the building envelope shall be screened from public view using landscape and architectural elements (see Fig. H.20).

**Guidelines**

- G1. Screens, enclosures, and any other devices used to screen service facilities such as trash and loading areas should be consistent with the overall building architecture in form, material, and detail (see Fig. H.20).

**E. DESIGN GUIDELINES**

These are recommendations for the architectural treatment and organization of buildings and open space and are the criteria for reviewing projects during the design review process.

**1. Development Massing**

New development should preserve the rhythm and fine-grained pedestrian scale of existing buildings within the Historic Retail District by respecting the relatively narrow building increments, which are predominantly 25’ to 50’ in width.

**2. Building Coverage**

In order to create well-defined street spaces consistent with the scale of downtown MountainView, side yards are discouraged in favor of contiguous building facades along the street. However, narrow mid-block pedestrian passages that encourage through-block pedestrian circulation and/or arcaded spaces that create wider sidewalk areas for cafés, etc. are encouraged.



*Fig. H.21: Sidewalk cafés and an engaging pedestrian experience Downtown.*



*Fig. H.22: Both small and large-scale new development should preserve the rhythm and fine-grained pedestrian scale of existing buildings within the Historic Retail District by respecting the relatively narrow building increments, which are predominantly 25’ to 50’.*

### 3. Ground-Level Corner Uses

High activity-generating uses are especially encouraged at the Castro Street intersections. Entries to elevator lobbies should not be located at intersections.

### 4. Ground-Level Treatment

The unique community character created by the mixture of building ages and architectural styles and the architectural design influence of historic buildings should be encouraged. All street-frontage establishments should provide primary access directly to the street. Long expanses of inactive building frontage should be avoided by placing street doors at intervals no greater than 50' and by maintaining 60 percent of the ground-level building facade in transparent window surface. All buildings should incorporate a base in their design.

The visual experience of moving along the street should be enjoyable and interesting. A change in major compositional elements of the street-level facade design is recommended at intervals of 25' to 50'. Colorful awnings overhanging the sidewalk are also recommended to further enhance the life and variety of the street.

Particular attention should be given to craftsmanship and detailing within the pedestrian's range of touch and view. For instance, the use of special storefront detailing and facade ornamentation such as flower boxes and special materials, can reinforce the pedestrian nature of the street.

Businesses fronting mid-block pedestrian passageways should provide direct access to those passageways, with attractively framed windows and doorways.

On cross-streets, while the overall goal is to have build-to lines at the front of buildings, ground-floor facades may be set back for outdoor activities.

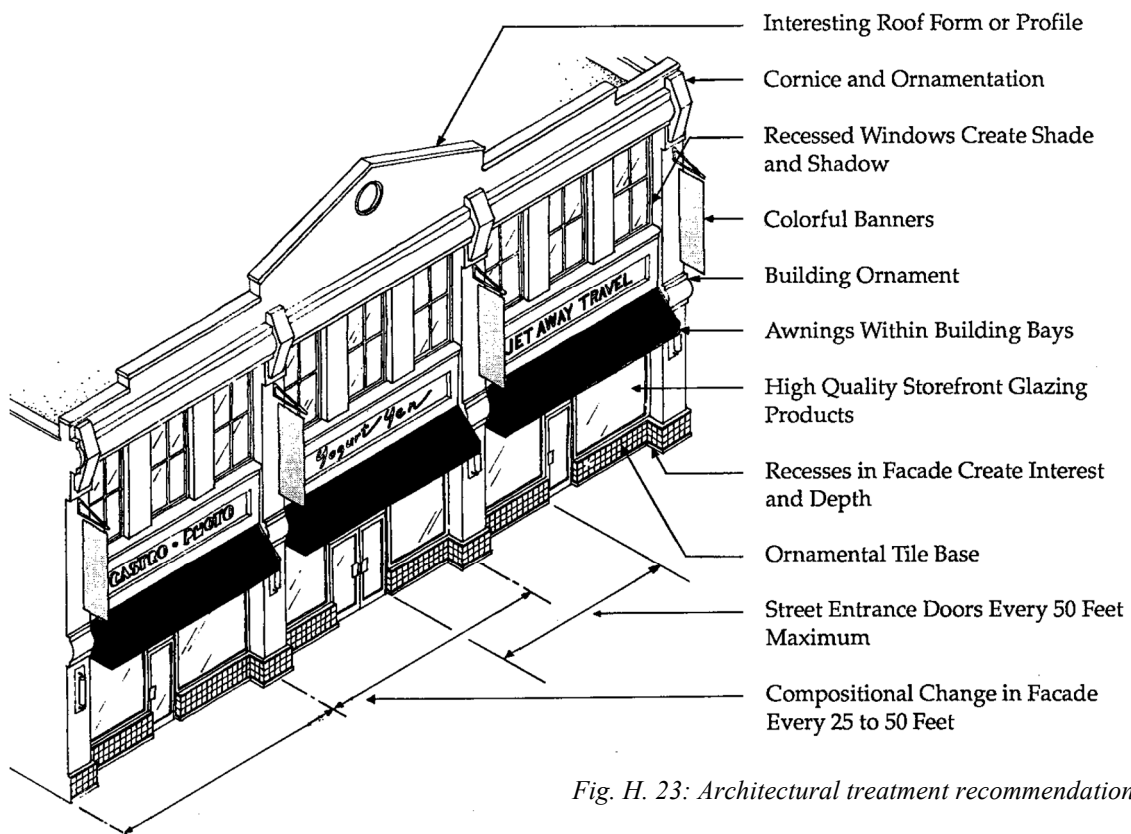

Fig. H. 23: Architectural treatment recommendations

#### 4. Entrances

Commercial entrances should be recessed from the facade, creating a small alcove. This establishes a more definitive sense of entry and affords an alternative view of merchandise in the display windows. Existing recessed entries should be retained.

The doors of a commercial storefront typically contain large glass panels with vertical proportions that presents a visual connection to the streetscape. Retain and restore original historic doors and their frames where possible.

#### 5. Facade Treatment

To maintain the present scale and character of buildings in the Historic Retail District, large uninterrupted expanses of horizontal and vertical wall surface should be avoided. Building facades should respond to the relatively narrow increments of development (25' to 50') with variation in fenestration, building materials and/or building planes.

Facades on both new and rehabilitated buildings should include the elements that make up a complete storefront including doors, display windows, bulkheads, transom windows, signage and awnings. New buildings need not mimic an “historical” architectural style but should include these architectural features, details and materials where appropriate to be compatible with and reinforce existing buildings. Preservation of existing historic details and materials should be encouraged.

Even if separate businesses function within the same building, the overall design of the facade must be consistent. Individual businesses should not break the basic lines, material and concept of the facade. Storefronts can be demarcated from each other within the same building by subtle variations in the color or pattern of surfaces of doors, tiling, signage or entries.

Corner parcels are encouraged to incorporate special features such as rounded or cut corners, special corner entrances, display windows, corner roof features, etc.



*Fig. H.24: New storefront renovation on Castro Street. Entrances should be recessed from the facade, creating a small alcove.*

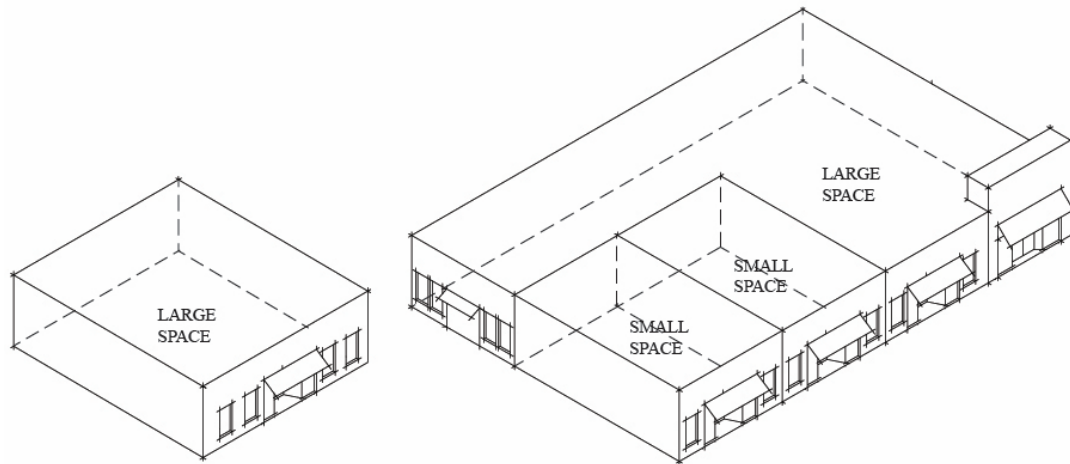

*Fig. H.25: Smaller retail spaces create frequent entrances and display windows. Larger spaces should replicate this pattern by incorporating multiple windows or wrapping around smaller retail spaces.*

## 6. Guidelines for Upper-Story Setbacks Castro Street Frontages

While the height limit is 50' along the 100 and 200 blocks of Castro Street, many of the existing buildings and, in particular, buildings with historic character have facades and heights in the range of 30' to 35'. New buildings and building additions should reinforce the historic pattern with heights and setbacks oriented to the 30' to 35' reference. Castro Street facades in the 100 and 200 blocks should be no taller than 30' to 40'. Upper levels in excess of 30' to 40' should be set back 10' to 12' from the facade. In the 300 block fronting Castro Street, upper levels in excess of 40' to 45' should be set back 10' to 12' from the facade.

## 7. Windows

### *General*

Building walls should be punctuated by well-proportioned openings that provide relief, detail and variation on the facade. Windows should be inset from the building wall to create shade and shadow detail. The use of high-quality window products that contribute to the richness and detail of the facade is encouraged.

### *Display Windows*

Size, division and shape of display windows should maintain the established rhythm of the streetscape. Glass used in the display windows should be clear. Tinted glazing is discouraged and mirrored/reflective glass is not permitted.

## 8. Roof Treatment

Building roof forms fronting Castro Street should reinforce the character of historic commercial buildings, which typically have flat, rather than pitched, roofs with vertical facade extensions above the roofline, known as parapets. Architectural elements such as cornices, special facing materials and/or decorative details are encouraged on the parapet.

Special attention should be paid to the articulation of the top portion of buildings through the introduction of horizontal bands, cornices and step-backs. Roof lines should be broken at intervals no greater than 50' by loggias, changes in height or step-backs to reinforce the typical building increment of 25' to 50' along Castro Street. Interesting and varied roof forms consistent with the pattern of existing buildings are encouraged.



Fig. H.26: Building roof forms fronting Castro Street should reinforce the character of the historic commercial buildings with flat roof forms, parapets, cornices and decorative details.

On the Bryant Street and Hope Street frontages, four-story buildings shall be compatible with the existing and potential development across the street. Design approaches such as top-floor setbacks and facade articulation can be used to create a compatible transition.

Rooftop equipment shall be concealed from view and/or integrated within the architecture of the building.

### 9. Building Materials

Building materials should be richly detailed to provide visual interest. Reflective glass is considered an undesirable material because of its tendency to create uncomfortable glare conditions and a forbidding appearance. Metal siding and large expanses of wood siding are also to be avoided. Materials should be light in color: earth tones, pastels or whites accented with dark or bright colors are considered compatible with existing architecture in the area. Roofing materials and accenting features such as canopies, cornices, tile accents, etc. should also offer color variation.

Character and richness in downtown can be enhanced from the incorporation of details and ornamentation into the design of the buildings. These elements can include cornices, brackets or moldings.

### 10. Site Access

Curb cuts are prohibited in the first four blocks of Castro Street and should be avoided on the rest of Castro Street. If new curb cuts within the Historic Retail blocks become necessary, they are encouraged to locate on the east-west cross streets beyond the alleys in order to maximize



Fig. H.27: Trash and loading areas should be well screened from view in structures that are consistent with the building design in both materials and detailing.

visibility and accessibility from Castro Street, minimize conflicts with pedestrian circulation, and to avoid circulation conflicts on the north-south streets.

Any on-site parking garage must be accessed in a safe, attractive manner and must not interfere with the orderly flow of traffic on public streets and parking lots.

## 11. Special Conditions

*Castro Street and California Street Intersection*—Buildings forming a portion of the intersection of Castro and California Streets should incorporate special corner treatments that reinforce the key significance of this intersection within the downtown (*see Fig. H.26*).

*Evelyn Avenue*—Buildings fronting Evelyn Avenue should recognize the role of this street as a highly visible edge of the downtown retail district by paying particular attention to upper-level treatment and detailing that is recognizable and distinctive from a distance (colorful canopies, fenestration, interesting roof forms, facade ornamentation, etc.).

## 12. Guidelines for Rears of Buildings

Because the alleys in downtown are highly visible and are used for both pedestrian access and vehicular service access, rear facades should exhibit high levels of design and materials quality similar to front facades. Rear facades of existing buildings should be improved with design features and quality materials where possible.

Buildings should have windows and doors oriented to the alley. Entry doors, garage doors and windows should be attractive and durable.

Service facilities such as trash enclosures and mechanical equipment should be screened with enclosures and devices consistent with the building architecture in form, material and detail. Roofs and trellises are recommended for screening views from above.

Where security devices are desired or warranted, designs should be artful with decorative grillwork that enhances the overall building design. Alley areas should be well lit but should be designed so as not to adversely impact adjacent properties.



*Fig. H.28: Alley facades should exhibit high levels of design and materials quality similar to front facades.*

## 13. Guidelines for Residential and Mixed-Use

### *Setbacks*

To reinforce the downtown commercial character of the Historic Retail District, mixed-use buildings with a residential component shall conform to the setback standards for commercial projects. The Zoning Administrator may allow increased side and rear setbacks to enhance the residential portion of a mixed-use project provided the setbacks do not detract from the commercial storefront character of the downtown district.

### ***Noise and Ground Vibrations***

Projects with a residential component on Castro Street should be designed to minimize noise impacts on residents from Castro Street and the Caltrain line. A noise analysis prepared by a qualified acoustical engineer is required for all residential projects fronting Castro Street. The acoustical engineer's report shall identify any noise impacts and measures to reduce these impacts to acceptable levels.

### ***Parking Design***

Parking for residential uses shall be provided on-site per Downtown Precise Plan Requirements Section II.C, Parking Standards and Policies.

Below-grade parking shall not extend above grade. Parking garage access should be integrated into the overall building facade design.

### ***Service Areas***

Design of service areas shall be consistent with the general guidelines for rears of buildings in Area H. On-site trash receptacles should be consolidated in one area that is easily accessible for garbage pickup from a street or alley.



*Fig. H.29: Attractive outdoor patio dining in Area H.*

### ***Ground-Level Treatment***

Commercial frontages should meet the general guidelines for ground-level treatment in Area H. Commercial spaces should have a depth of at least 40' to ensure viability. Pedestrian access to residential units from Castro Street should be through a single common entrance. Residential and commercial entrances should be separate and distinct.

### ***Facade Treatment***

To maintain the scale and character of the downtown district, large, uninterrupted expanses of horizontal and vertical wall surface should be avoided. Building facades should respond to the relatively narrow increments of development (25' to 50') with variation in fenestration, building materials and/or building planes.

Corner parcels are encouraged to incorporate special features such as rounded or cut corners, special corner entrances, display windows, corner roof features, etc.

### ***Development Massing***

Buildings may be up to four stories, which is taller than most existing buildings in Area H and most of the downtown transition areas within the Precise Plan. This additional height requires particular attention to the massing of the buildings to ensure an appropriate transition with the surrounding development. New residential development on larger parcels should echo the narrow parcel increments on Castro Street, with sensitivity to the traditional building size and storefronts on Castro Street.

### ***Roof Treatment***

Mixed-use buildings with a residential component facing Castro Street should exhibit an architectural character consistent with the downtown commercial character. Flat, hip and mansard roof forms are appropriate; gabled roofs are discouraged. On Hope and Bryant Streets, rooflines may be varied to be compatible with surrounding residential development.

### ***Lighting***

Exterior lighting features shall be oriented and directed downward to protect neighboring residents from excess light and glare.

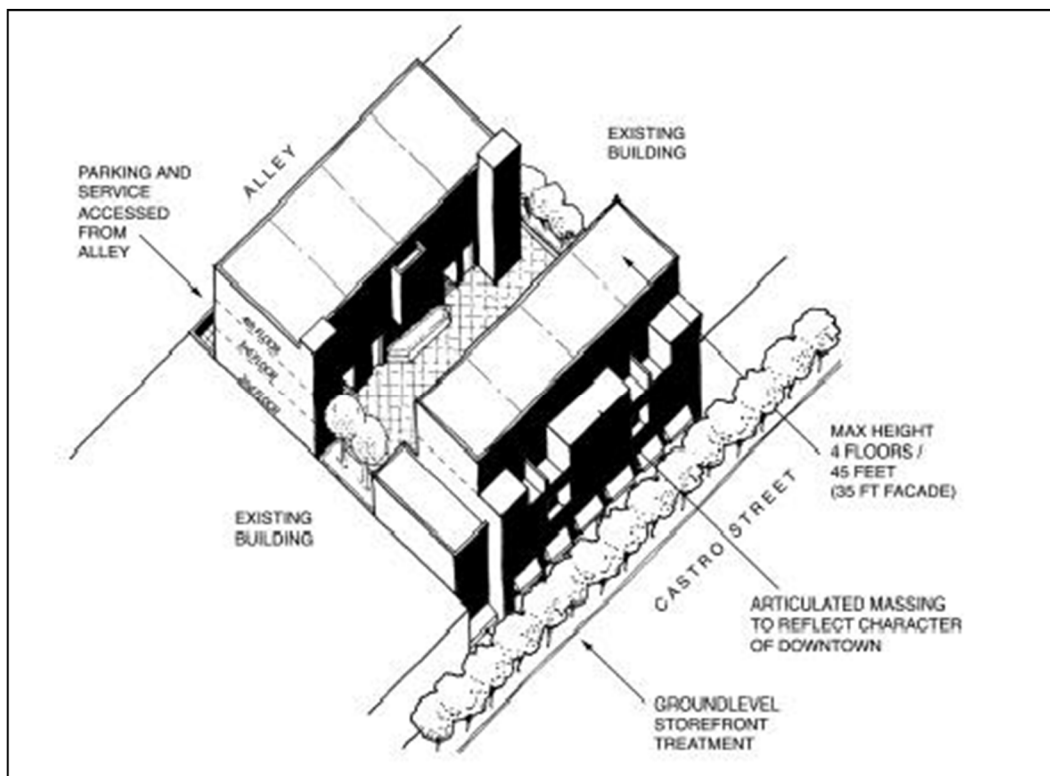

Fig. H.30: Mixed-Use Residential Prototype (100 and 200 Blocks of Castro Street) Area H



### 14. Guidelines for Pedestrian Passageways

New buildings and building renovations adjacent to existing pedestrian passageways leading from rear parking areas to Castro Street should be reinforced with features that provide interest such as windows, trellises, benches, planting and attractive lighting. Passageways may be further enhanced with small plazas at either end or at midpoints with provisions for amenities such as seating, planting and fountains.



Fig. H.31: Pedestrian passageways leading from rear parking areas to Castro Street should be reinforced with features that provide interest such as windows, trellises, benches, planting, and attractive lighting.

### 15. Guidelines for Open Space

Private open space within the downtown area is not intended to provide recreational or large landscaped areas, since this is a more urban environment and there are ample recreational opportunities downtown in Pioneer and Eagle Parks. However, open space is an important element and should be used effectively to articulate building forms, promote access to light and fresh air and maintain privacy for downtown residents.

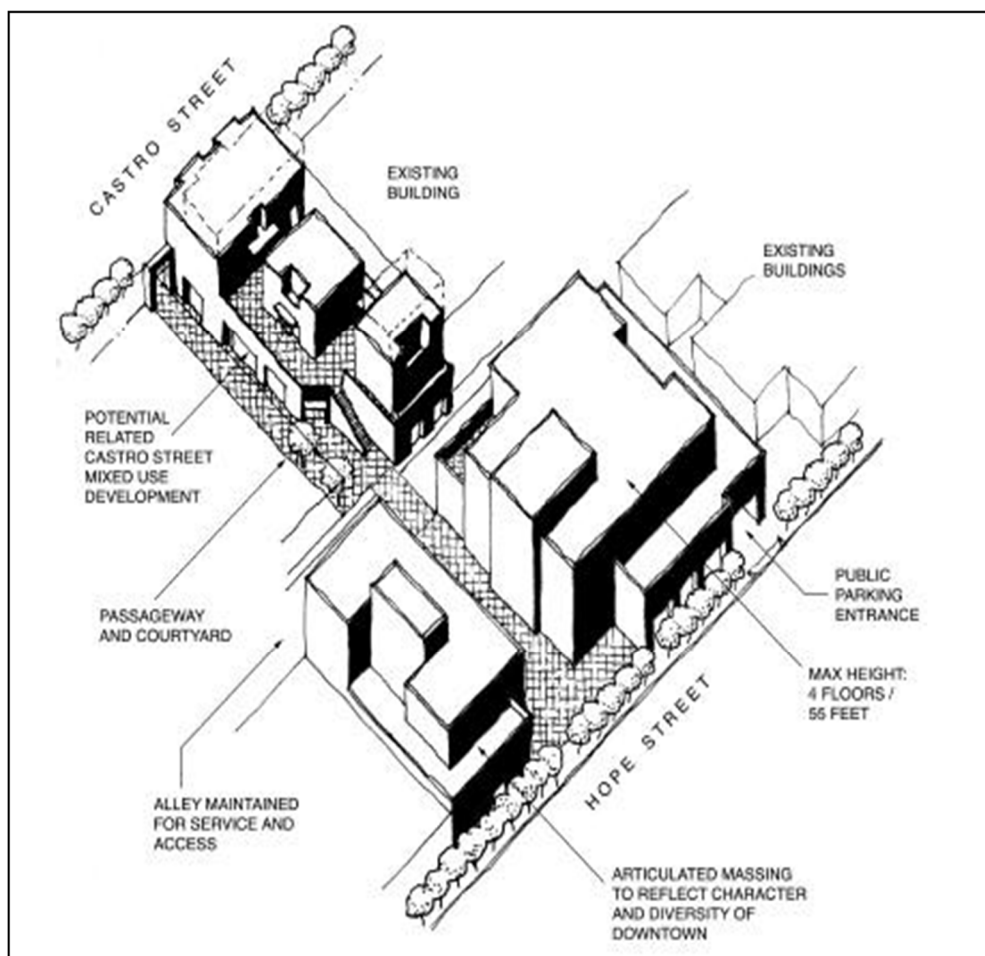

Fig. H.32: Mixed-Use Parking Lot Infill Prototype

In residential development, most open space should be used to provide attractive amenities for residents, including interior courtyards and perimeter landscaping. Commercial development should typically have less open space in order to maintain a direct pedestrian relationship and continuous storefront streetscape. Open space for nonresidential projects should provide a visual amenity for the development and an attractive buffer to adjacent residential uses where applicable.

Open spaces such as retail plazas and outdoor seating areas should be located at building entries or along or near well-traveled pedestrian routes to encourage frequent and spontaneous use. Amenities should be functional as well as visually appealing, with seating, tables, canopies and covering trellises. Plazas and open spaces should be generously landscaped with trees, planters and vines. Low walls may be used to screen service and mechanical areas, create spatial definition and for providing seating. Low walls should be designed of quality materials.

For residential projects, open space should include evergreen trees for screening, specimen trees for visual color and attractive shrubs and ground cover. Low walls and planters may be used to provide privacy between open space areas and residences.

## 16. Guidelines for Mixed-Use Development on Public Parking Lots

For infill development on one of the public parking lots, all development regulations for Area H apply. In addition, all required parking for the new development as well as parking to replace all existing spaces shall be provided on-site in a subgrade parking structure with access from the midblock alley and one of the adjacent side or cross-streets.

Infill buildings should be carefully designed and detailed so that scale and massing respond to the traditional small downtown parcel scale and provides a sensitive transition to adjacent residential neighborhoods. To maintain the present scale and character of buildings in the Historic Retail District, large uninterrupted expanses of horizontal and vertical wall surface should be avoided. Building facades and rooflines should respond to the relatively narrow increments of development (up to 25') with variation in fenestration, building materials, roof forms and/or building planes.

Passageways connecting the parking lot development with Castro Street should be carefully detailed to enhance the pedestrian experience (*see Fig. H.33*).

Windows and doors from the adjacent building, seating, planting and attractive lighting should be included. Where the passageway meets the new building, a carefully designed transition such as a plaza open space should occur and a continuation of the passageway to the side street should be considered.

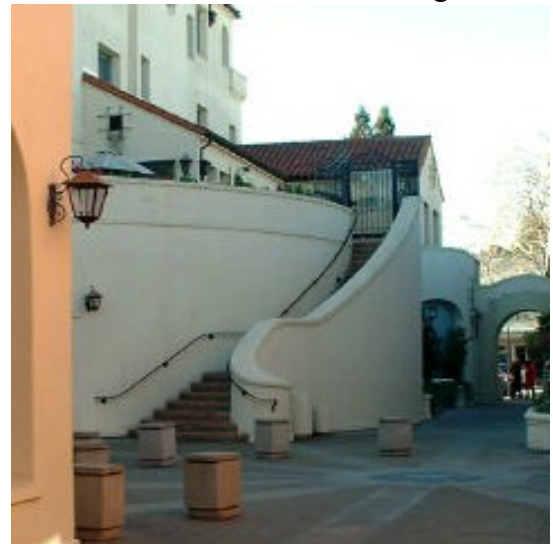

*Fig. H.33: Passageways connecting parking facilities with Castro Street may be further enhanced with small plazas with provisions for amenities such as seating, planting, and fountains.*