

OWNER'S STATEMENT

WE HEREBY STATE THAT WE ARE THE OWNERS OF, OR HAVE SOME RIGHT, TITLE OR INTEREST IN AND TO, THE REAL PROPERTY INCLUDED WITHIN THE SUBDIVISION SHOWN UPON THIS MAP, AND THAT WE ARE THE ONLY PERSONS WHOSE CONSENT IS NECESSARY TO PASS CLEAR TITLE TO SAID PROPERTY, AND WE HEREBY CONSENT TO THE PREPARATION AND RECORDATION OF SAID MAP AND SUBDIVISION AS SHOWN WITHIN THE DISTINCTIVE BORDERLINE.

WE ALSO HEREBY DEDICATE TO PUBLIC USE, EASEMENTS FOR STREET AND UTILITY PURPOSES AND OTHER SIMILAR USES AS DULY AUTHORIZED BY THE CITY OF MOUNTAIN VIEW UNDER, UPON AND OVER THE AREAS DESIGNATED ON THIS MAP AS "STREET EASEMENT".

WE ALSO HEREBY DEDICATE FOR PUBLIC USE, EASEMENTS FOR UNDERGROUND PUBLIC UTILITY FACILITIES, DESIGNATED ON THIS MAP AS "PUBLIC UTILITY EASEMENT" (PUE), FOR SUCH USE AS SANITARY SEWERS, WATER MAINS, STORM DRAINS, GAS MAINS, PUBLIC UTILITIES, INCLUDING ELECTRIC, COMMUNICATION AND CABLE TELEVISION FACILITIES, AND OTHER SIMILAR USES, TOGETHER WITH APPURTENANCES THEREOF AND WITH RIGHTS OF INGRESS AND EGRESS. SAID PUBLIC UTILITY EASEMENT SHALL BE KEPT OPEN AND FREE FROM BUILDINGS AND STRUCTURES OF ANY KIND EXCEPT LAWFUL FENCES, SURFACE PAVEMENT, LAWFUL UNSUPPORTED ROOF OVERHANGS, IRRIGATION SYSTEMS, UTILITY COMPANY STRUCTURES AND APPURTENANCES THEREOF.

WE ALSO HEREBY DEDICATE FOR PUBLIC USE, EASEMENTS FOR WATER METERS AND ASSOCIATED FACILITIES, DESIGNATED ON THIS MAP AS "WATER METER EASEMENT" (WME), FOR SUCH USE AS WATER METERS, TOGETHER WITH APPURTENANCES THEREOF AND WITH RIGHTS OF INGRESS AND EGRESS. SAID WATER METER EASEMENT SHALL BE KEPT OPEN AND FREE FROM BUILDINGS AND STRUCTURES OF ANY KIND EXCEPT LAWFUL FENCES, SURFACE PAVEMENT, LAWFUL UNSUPPORTED ROOF OVERHANGS, IRRIGATION SYSTEMS, UTILITY COMPANY STRUCTURES AND APPURTENANCES THEREOF.

WE ALSO HEREBY DEDICATE TO PUBLIC USE, EASEMENTS FOR INGRESS AND EGRESS OF EMERGENCY VEHICLES ACROSS THOSE AREAS DESIGNATED ON THIS MAP AS "EVAE" (EMERGENCY VEHICLE ACCESS EASEMENT").

THE AREA OF LAND DESIGNATED AS "PIEE" (PRIVATE INGRESS AND EGRESS EASEMENT) ARE RESERVED FOR THE USE BY THE HOMEOWNERS' AND RESIDENTS OF THIS SUBDIVISION AND THEIR LICENSEES, VISITORS, AND TENANTS, RECIPROCAL RIGHTS FOR INGRESS AND EGRESS. SAID EASEMENT AREAS ARE TO BE KEPT OPEN AND FREE OF SURFACE STRUCTURES OF ANY KIND. THE MAINTENANCE, REPAIR AND/OR REPLACEMENT OF SAID STRUCTURES SHALL BE THE SOLE RESPONSIBILITY OF THE HOMEOWNERS' ASSOCIATION AS DETERMINED BY THE APPROPRIATE COVENANTS, CONDITIONS AND RESTRICTIONS.

THE AREA OF LAND DESIGNATED AND DELINEATED AS "PSDE" (PRIVATE STORM DRAIN EASEMENT) ARE RESERVED FOR USE BY THE HOMEOWNERS' ASSOCIATION FOR THE INSTALLATION AND MAINTENANCE OF THE PRIVATE STORM DRAIN FACILITIES, AND SURFACE DRAINAGE OF STORM WATER. SAID EASEMENT AREAS ARE TO BE KEPT OPEN AND FREE OF SURFACE STRUCTURES OF ANY KIND. THE MAINTENANCE, REPAIR AND/OR REPLACEMENT OF SAID FACILITIES SHALL BE THE SOLE RESPONSIBILITY OF THE HOMEOWNERS' ASSOCIATION AS DETERMINED BY THE APPROPRIATE COVENANTS, CONDITIONS AND RESTRICTIONS.

LOTS A AND B ARE NOT OFFERED FOR DEDICATION AND ARE RESERVED FOR THE FUTURE CONVEYANCE TO THE HOMEOWNERS' ASSOCIATION OF THIS SUBDIVISION. LOTS A AND B ARE "COMMON AREA" AND ARE NOT DEDICATED FOR USE BY THE GENERAL PUBLIC BUT ARE RESERVED FOR THE USE OF THE HOMEOWNERS OF THE SUBDIVISION FOR, BUT NOT LIMITED TO, ACCESS, PARKING, UTILITIES, DRAINAGE, INGRESS AND EGRESS IN ACCORDANCE WITH THE SUBDIVISION RESTRICTIONS FOR THIS MAP. LOT A INCLUDES THE PRIVATE STREETS SHOWN ON THIS MAP.

THE AREA OF LAND DESIGNATED AND DELINEATED AS "PWLE" (PRIVATE WATER LINE EASEMENT) IS RESERVED FOR USE BY THE HOMEOWNERS' ASSOCIATION FOR THE INSTALLATION AND MAINTENANCE OF THE PRIVATE WATER FACILITIES, SAID EASEMENT AREAS ARE TO BE KEPT OPEN AND FREE OF SURFACE STRUCTURES OF ANY KIND. THE MAINTENANCE, REPAIR AND/OR REPLACEMENT OF SAID FACILITIES SHALL BE THE SOLE RESPONSIBILITY OF THE HOMEOWNERS' ASSOCIATION AS DETERMINED BY THE APPROPRIATE COVENANTS, CONDITIONS AND RESTRICTIONS.

THE AREAS OF LAND DESIGNATED AND DELINEATED AS "PVUE" (PRIVATE UTILITY EASEMENT) ARE RESERVED FOR USE BY THE HOMEOWNERS' ASSOCIATION FOR THE INSTALLATION OF PRIVATE UTILITIES SUCH AS, GAS MAINS, ELECTRIC, COMMUNICATION AND CABLE TELEVISION FACILITIES, AND OTHER SIMILAR USES, TOGETHER WITH APPURTENANCES THEREOF AND WITH RIGHTS OF INGRESS AND EGRESS. SAID EASEMENTS SHALL BE KEPT OPEN AND FREE FROM BUILDINGS AND STRUCTURES OF ANY KIND EXCEPT LAWFUL FENCES, SURFACE PAVEMENT, LAWFUL UNSUPPORTED ROOF OVERHANGS, IRRIGATION SYSTEMS, UTILITY COMPANY STRUCTURES AND APPURTENANCES THEREOF. THE MAINTENANCE, REPAIR AND/OR REPLACEMENT OF SAID FACILITIES SHALL BE THE SOLE RESPONSIBILITY OF THE HOMEOWNERS' ASSOCIATION AS DETERMINED BY THE APPROPRIATE COVENANTS, CONDITIONS AND RESTRICTIONS.

THE AREAS OF LAND DESIGNATED AND DELINEATED AS "SDRE" (SURFACE DRAINAGE RELEASE EASEMENT) ARE RESERVED FOR SURFACE FLOW OF STORM WATER ON OR OVER THOSE CERTAIN STRIPS OF LAND DESIGNATED ON THIS MAP WITHIN LOT 2 AND LOT 3 FOR THE BENEFIT OF THE HOMEOWNERS' ASSOCIATION. SAID EASEMENTS SHALL BE KEPT OPEN AND FREE OF ANY OBSTRUCTIONS, INCLUDING, BUT NOT LIMITED TO, BERMS, BUILDINGS, OR PERMANENT STRUCTURES OF ANY KIND; ALSO, SAID SURFACE ELEVATIONS SHALL NOT BE ALTERED WITHOUT THE WRITTEN CONSENT OF THE HOMEOWNERS' ASSOCIATION BY THE APPROPRIATE COVENANTS, CONDITIONS AND RESTRICTIONS.

OWNERS: TAYLOR MORRISON OF CALIFORNIA, LLC, A CALIFORNIA LIMITED LIABILITY COMPANY

NAME: _____ SIGNED: _____

TITLE: _____ DATE: _____

TRACT 10380

FOR CONDOMINIUM PURPOSES
660 TYRELLA AVENUE

A SUBDIVISION OF THE LANDS OF
TAYLOR MORRISON OF CALIFORNIA, LLC AS DESCRIBED IN
THE GRANT DEED RECORDED ON JULY 8, 2016
IN DOC. NO. 23359644, SANTA CLARA COUNTY RECORDS
LYING ENTIRELY WITHIN THE CITY OF MOUNTAIN VIEW
COUNTY OF SANTA CLARA, STATE OF CALIFORNIA

CONSISTING OF 3 SHEETS

MAY 2017



WOOD RODGERS
DEVELOPING INNOVATIVE DESIGN SOLUTIONS
4670 Willow Road, Suite 125 Tel 925.847.1556
Pleasanton, CA. 94588 Fax 925.847.1557

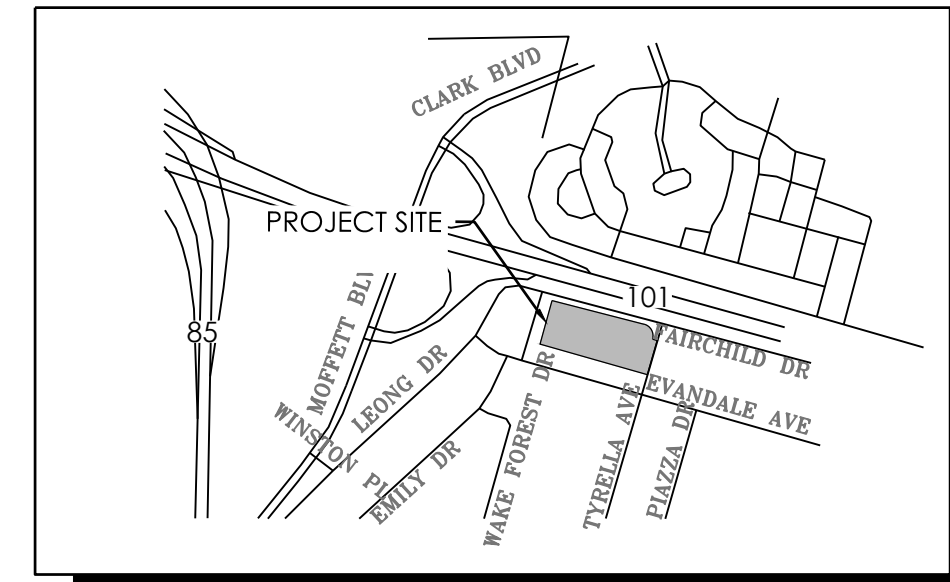

NOT TO SCALE
VICINITY MAP

OWNER'S ACKNOWLEDGEMENT

A NOTARY PUBLIC OR OTHER OFFICER COMPLETING THIS CERTIFICATE VERIFIES ONLY THE IDENTITY OF THE INDIVIDUAL WHO SIGNED THE DOCUMENT TO WHICH THIS CERTIFICATE IS ATTACHED, AND NOT THE TRUTHFULNESS, ACCURACY, OR VALIDITY OF THAT DOCUMENT.

STATE OF _____ } SS.
COUNTY OF _____ }
ON _____ 20____, BEFORE ME, _____, A NOTARY PUBLIC IN AND FOR SAID COUNTY AND STATE, PERSONALLY APPEARED _____, WHO PROVED TO ME ON THE BASIS OF SATISFACTORY EVIDENCE TO BE THE PERSON(S) WHOSE NAME(S) IS/ARE SUBSCRIBED TO THE WITHIN INSTRUMENT AND ACKNOWLEDGED TO ME THAT HE/SHE/THEY EXECUTED THE SAME IN HIS/HER/THEIR AUTHORIZED CAPACITY(IES), AND THAT BY HIS/HER/THEIR SIGNATURE(S) ON THE INSTRUMENT THE PERSON(S) OR THE ENTITY UPON BEHALF OF WHICH THE PERSON(S) ACTED, EXECUTED THE INSTRUMENT.

I CERTIFY UNDER PENALTY OF PERJURY UNDER THE LAWS OF THE STATE OF CALIFORNIA THAT THE FOREGOING PARAGRAPH IS TRUE AND CORRECT.

WITNESS MY HAND:

SIGNATURE: _____

NAME (PRINT): _____

PRINCIPAL COUNTY OF BUSINESS: _____

MY COMMISSION NO.: _____

MY COMMISSION EXPIRES: _____

CITY ACCEPTANCE STATEMENT

I, LORRIE BREWER, CITY CLERK AND EX-OFFICIO CLERK OF THE CITY COUNCIL OF THE CITY OF MOUNTAIN VIEW, STATE OF CALIFORNIA, HEREBY STATE THAT THE CITY COUNCIL DID AT ITS _____ MEETING HELD ON THE _____ DAY OF _____, 2017 MAKE ALL FINDING REQUIRED PURSUANT TO ARTICLE VII OF CHAPTER 28 OF THE MOUNTAIN VIEW CITY CODE AND DID DULY APPROVE THE WITHIN FINAL MAP OF TRACT NO. 10380 AND DID ACCEPT, SUBJECT TO IMPROVEMENTS, ON BEHALF OF THE PUBLIC, EASEMENTS OFFERED FOR DEDICATION THEREON FOR THE PURPOSES SET FORTH IN THE OFFER OF DEDICATION.

PURSUANT TO GOVERNMENT CODE SECTION 66434(G), I HEREBY ABANDON THOSE PORTIONS OF THE PUBLIC UTILITY AND STREET EASEMENT RECORDED ON JUNE 15, 1962 IN BOOK 5612 AT PAGE 624 OF OFFICIAL RECORDS OF THE COUNTY OF SANTA CLARA, STATE OF CALIFORNIA, THAT ARE LOCATED WITHIN THE BOUNDARY OF THIS MAP AS SHOWN ON SHEET 2 OF THIS MAP. SAID EASEMENT IS BEING REPLACED BY ANOTHER PUBLIC STREET EASEMENT CREATED BY THIS TRACT MAP.

DATE: _____

RESOLUTION NO. _____

LORRIE BREWER, MMC
CITY CLERK AND EX-OFFICIO
CLERK OF THE CITY COUNCIL OF THE
CITY OF MOUNTAIN VIEW, CALIFORNIA

SOILS REPORT STATEMENT

A SOILS REPORT ENTITLED "GEOTECHNICAL EXPLORATION 660 TYRELLA DRIVE MOUNTAIN VIEW, CALIFORNIA" AND DATED AUGUST 29, 2016 WAS PREPARED BY ENGeo, 6399 SAN IGNACIO AVENUE, SUITE 150 SAN JOSE, CA 95119, JOB NO. 11591.001.000 AND SIGNED BY THEODORE P. BAYHAM, GE, CEG 2480

SURVEYOR'S STATEMENT

THIS MAP WAS PREPARED BY ME OR UNDER MY DIRECTION, AND IS BASED UPON A FIELD SURVEY TRUE AND COMPLETE AS SHOWN IN CONFORMANCE WITH THE REQUIREMENTS OF THE SUBDIVISION MAP ACT AND LOCAL ORDINANCE, AT THE REQUEST OF TAYLOR MORRISON OF CALIFORNIA, LLC IN JULY 2016. I HEREBY STATE THAT THIS FINAL MAP SUBSTANTIALLY CONFORMS TO THE CONDITIONALLY APPROVED TENTATIVE MAP. ALL MONUMENTS ARE OF THE CHARACTER AND WILL BE SET IN THOSE POSITIONS INDICATED ON OR BEFORE JANUARY 30, 2018, AND THAT THE MONUMENTS WILL BE SUFFICIENT TO ENABLE THE SURVEY TO BE RETRACED.

RYAN M. SEXTON _____ DATE _____
P.L.S 9177
EXPIRATION DATE: MARCH 31, 2019



CITY ENGINEER'S STATEMENT

I HEREBY STATE THAT I HAVE EXAMINED THE WITHIN FINAL MAP, THAT THE SUBDIVISION SHOWN HEREON IS SUBSTANTIALLY THE SAME AS IT APPEARED ON THE TENTATIVE MAP APPROVED BY THE CITY COUNCIL OF THE CITY OF MOUNTAIN VIEW ON _____ AND ANY APPROVED ALTERATIONS THEREOF, AND THAT ALL THE PROVISIONS OF THE CALIFORNIA STATE "SUBDIVISION MAP ACT", AND ANY OF MOUNTAIN VIEW CITY ORDINANCES APPLICABLE AT THE TIME OF APPROVAL OF SAID TENTATIVE MAP, HAVE BEEN COMPLIED WITH.

JACQUELINE ANDREWS SOLOMON _____ DATE _____
CITY ENGINEER
R.C.E. 57093
EXPIRATION DATE: 12-31-2017
CITY OF MOUNTAIN VIEW
SANTA CLARA COUNTY, CALIFORNIA



I, TIMOTHY Y. KO, A LICENSED CIVIL ENGINEER FOR THE CITY OF MOUNTAIN VIEW, SANTA CLARA COUNTY, CALIFORNIA, DO HEREBY STATE THAT I HAVE EXAMINED THE WITHIN FINAL MAP AND I AM SATISFIED THAT THIS MAP IS TECHNICALLY CORRECT.

TIMOTHY Y. KO _____
R.C.E. NO. 27089
EXPIRATION DATE: 03-31-2019



RECORDER'S STATEMENT

FILE NUMBER: _____ FEE: _____ PAID: _____

FILED THIS _____ DAY OF _____, 2017, _____ M IN BOOK _____

OF MAPS, AT PAGE _____ AT THE REQUEST OF FIRST AMERICAN TITLE COMPANY

REGINA ALCOMENDRAS, COUNTY RECORDER

BY: _____

DEPUTY

NOTES

1. ALL CURVE DIMENSIONS SHOWN ARE ARC LENGTH AND DELTA, ALL DISTANCES SHOWN ARE GROUND DISTANCES AND ARE EXPRESSED IN FEET AND DECIMALS THEREOF.
2. TOTAL AREA OF THIS SUBDIVISION CONTAINS 2.05± ACRES
3. THE DISTINCTIVE BORDER LINE DELINEATES THE BOUNDARY OF LAND SUBDIVIDED BY THIS MAP.
4. THERE ARE A TOTAL OF 6 RESIDENTIAL LOTS FOR 37 RESIDENTIAL CONDOMINIUM UNITS AND 2 COMMON AREA LOTS IN THIS SUBDIVISION.
5. A SOILS REPORT ENTITLED "GEOTECHNICAL EXPLORATION 660 TYRELLA DRIVE MOUNTAIN VIEW, CALIFORNIA" AND DATED AUGUST 29, 2016 WAS PREPARED BY ENGO, 6399 SAN IGNACIO AVENUE, SUITE 150 SAN JOSE, CA 95119, JOB NO. 11591.001.000 AND SIGNED BY THEODORE P. BAYHAM, GE, CEG 2480
6. ALL LOT LINES ARE RADIAL TO FRONTAGE CURVES UNLESS RADIAL BEARING IS SHOWN ON THE MAP
7. EASEMENT LINES CREATED BY THIS MAP ARE PARALLEL OR PERPENDICULAR TO THE LOT LINE IF A BEARING IS NOT SHOWN
8. INTERIOR LOT CORNERS AND ANGLE POINTS ALONG THE PRIVATE STREET ARE GENERALLY AT THE BACK OF CONCRETE CURB. MONUMENTS IN THIS LOCATION WILL BE SET AS A SCRIBE IN THE CONCRETE CURB OR WITH A 3/4" IRON PIPE TAGGED LS 9177

REFERENCES:

- (1) 166 M 35 (RECORD OF SURVEY)
- (2) 747 M 17-18 (PARCEL MAP)
- (3) 507 M 11 (PARCEL MAP)
- (4) 521 M 42-45 (RECORD OF SURVEY)
- (5) DOC. NO. 22393235 (GRANT DEED)
- (6) BOOK N OF MAPS PAGE 86 (MAP OF HAMWOOD, FEB 23, 1912)
- (7) CALTRANS MONUMENT MAP SC1-68A, MVW (HIGHWAY 101) S-71.12

Line Table - This Sheet Only		
No.	Bearing	Length
L1	N13°18'09"E	20.00'
L2	N14°08'18"E	20.00'

BASIS OF BEARINGS

THE BASIS OF BEARINGS FOR THIS SURVEY IS THE MONUMENT LINE ON TYRELLA AVENUE AS SHOWN ON RECORD OF SURVEY RECORDED IN BOOK 521 OF MAPS, PAGES 42-45, SANTA CLARA COUNTY RECORDS. SAID BEARING BEING IS N15°56'45"E. ALL DISTANCES SHOWN ARE GROUND BASED.

EXISTING EASEMENTS TO BE ABANDONED

1. A PERPETUAL EASEMENT FOR PUBLIC USE AS A STREET AND FOR THE PURPOSE OF LAYING, INSTALLING, MAINTAINING, REPAIRING, PROTECTING, REPLACING SANITARY SEWERS, WATER MAINS, STORM DRAINS, GAS MAINS, POLES, OVERHEAD AND UNDERGROUND AND ELECTRICAL, TELEPHONE WIRES, ELECTROLIERS, OTHER MUNICIPAL USES AND INCIDENTAL PURPOSES, RECORDED JUNE 15, 1962 AS BOOK 5612, PAGE 624 OF OFFICIAL RECORDS. IN FAVOR OF: THE CITY OF MOUNTAIN VIEW, A MUNICIPAL CORPORATION

LEGEND

- FOUND STANDARD CITY MONUMENT AS NOTED
- FOUND MONUMENT AS NOTED
- ⊗ SET SCRIBE IN CONCRETE CURB OR 3/4" IRON PIPE TAGGED LS 9177
- ⊙ STANDARD CITY MONUMENT WELL STAMPED L.S. 9177 SET PER THIS MAP
- M-M MONUMENT TO MONUMENT
- EVAE EMERGENCY VEHICLE ACCESS EASEMENT
- SDRE SURFACE DRAINAGE RELEASE EASEMENT
- PIEE PRIVATE INGRESS & EGRESS EASEMENT
- PSDE PRIVATE STORM DRAIN EASEMENT
- PUE PUBLIC UTILITY EASEMENT
- PVUE PRIVATE UTILITY EASEMENT
- PWLE PRIVATE WATER LINE EASEMENT
- WME WATER METER EASEMENT
- (OA) OVERALL DISTANCE
- (R) RADIAL LINE
- SF SQUARE FEET
- SFNF SEARCHED FOR NOT FOUND
- () RECORD DATA NOT USED
- (1) RECORD REFERENCE
- SUBDIVISION BOUNDARY
- LOT LINE
- CENTERLINE
- MONUMENT LINE
- EXISTING EASEMENT LINE
- PROPOSED EASEMENT LINE

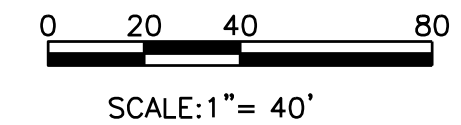

TRACT 10380

FOR CONDOMINIUM PURPOSES
660 TYRELLA AVENUE

A SUBDIVISION OF THE LANDS OF
TAYLOR MORRISON OF CALIFORNIA, LLC AS DESCRIBED IN
THE GRANT DEED RECORDED ON JULY 8, 2016
IN DOC. NO. 23359644, SANTA CLARA COUNTY RECORDS
LYING ENTIRELY WITHIN THE CITY OF MOUNTAIN VIEW
COUNTY OF SANTA CLARA, STATE OF CALIFORNIA

WOOD RODGERS
DEVELOPING INNOVATIVE DESIGN SOLUTIONS
4670 Willow Road, Suite 125 Tel 925.847.1556
Pleasanton, CA. 94588 Fax 925.847.1557

MAY 2017

Sheet 2 of 3

3416.001

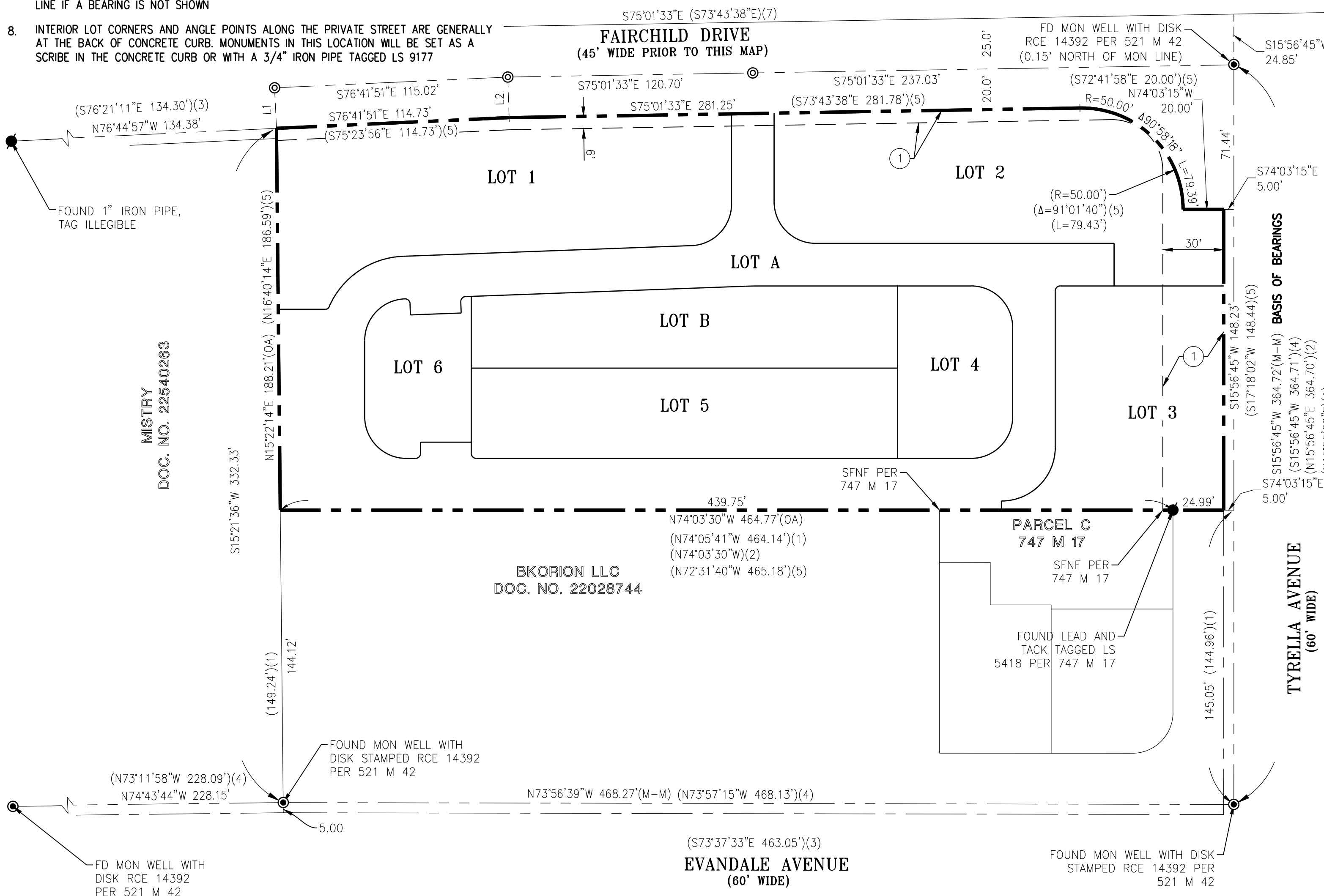

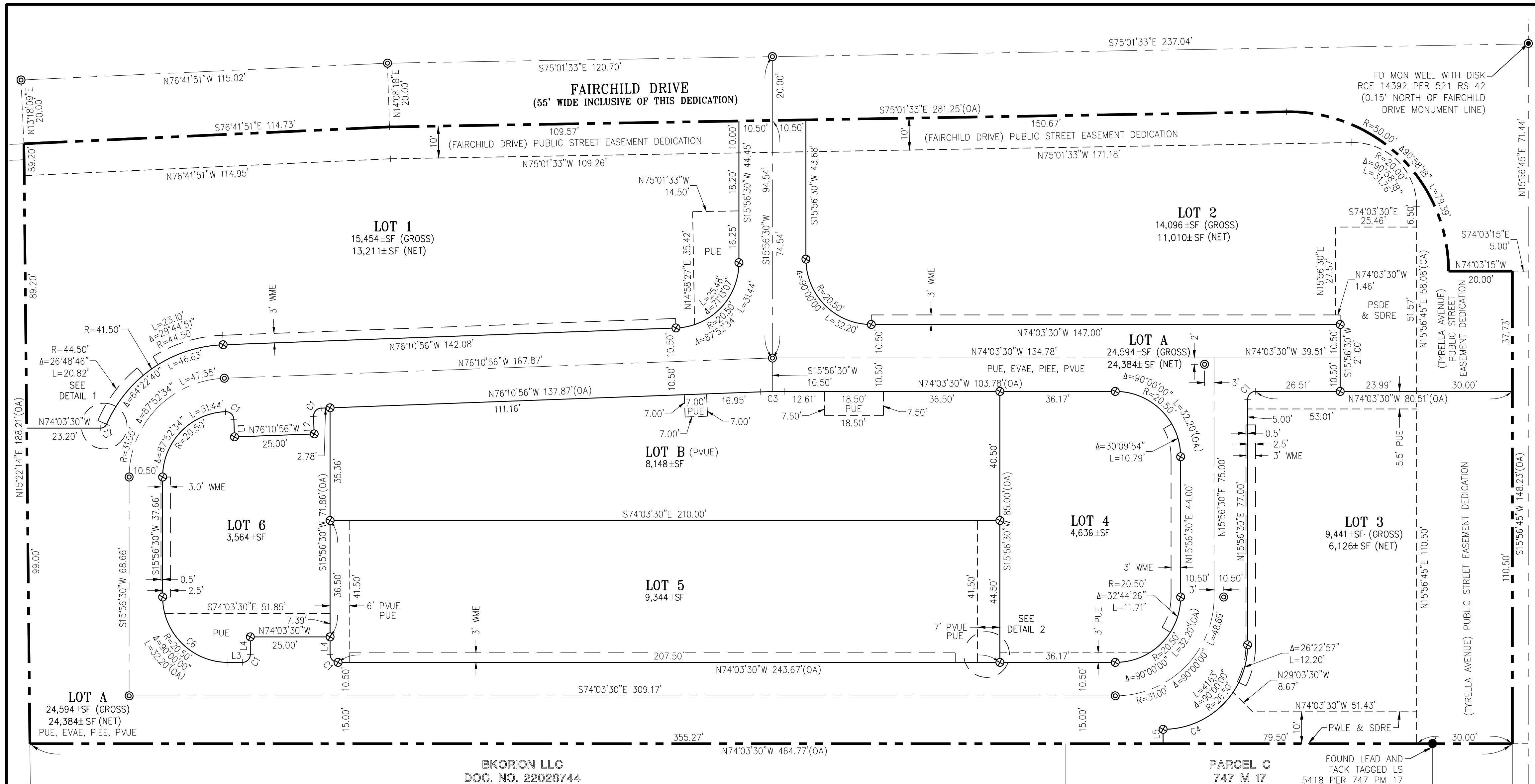

BKORION LLC
DOC. NO. 22028744

PARCEL C
747 M 17

FOUND LEAD AND
TACK TAGGED LS
5418 PER 747 PM 17

TRACT 10380

FOR CONDOMINIUM PURPOSES
660 TYRELLA AVENUE

A SUBDIVISION OF THE LANDS OF
TAYLOR MORRISON OF CALIFORNIA, LLC AS DESCRIBED IN
THE GRANT DEED RECORDED ON JULY 8, 2016
IN DOC. NO. 23359644, SANTA CLARA COUNTY RECORDS
LYING ENTIRELY WITHIN THE CITY OF MOUNTAIN VIEW
COUNTY OF SANTA CLARA, STATE OF CALIFORNIA

Curve Table - This Sheet Only

No.	Radius	Delta	Length
C1	2.50'	90°00'00"	3.93'
C2	2.00'	66°30'06"	2.32'
C3	199.50'	2°07'26"	7.40'
C4	26.50'	55°52'33"	25.84'
C5	40.00'	20°14'24"	14.13'
C6	27.03'	75°33'21"	20.97'

Line Table - This Sheet Only

No.	Bearing	Length
L1	N13°49'04"E	5.50'
L2	N13°49'04"E	5.50'
L3	N74°03'30"W	4.50'
L4	N15°56'30"E	5.50'
L5	N15°56'30"E	4.50'

SEE SHEET 2 FOR LEGEND

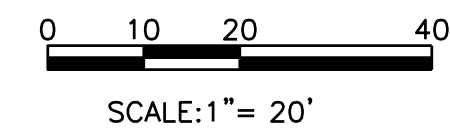
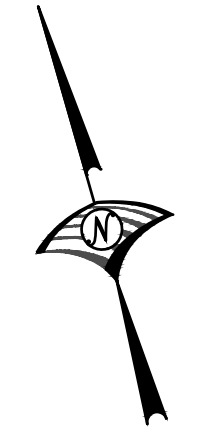
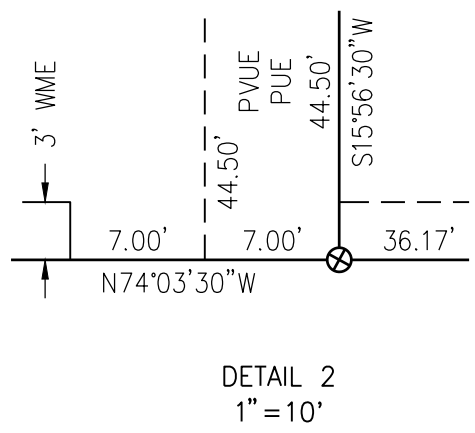
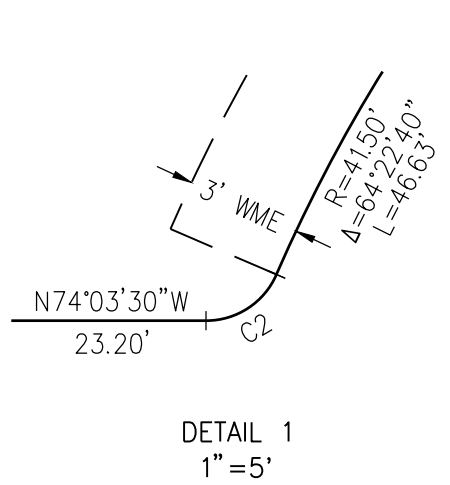

MAY 2017

WOOD RODGERS
DEVELOPING INNOVATIVE DESIGN SOLUTIONS
4670 Willow Road, Suite 125 Tel 925.847.1556
Pleasanton, CA. 94588 Fax 925.847.1557

Sheet 3 of 3
3416.001